

RT2875B Synchronous Step-Down Converter Evaluation Board

Purpose

The RT2875B is a high efficiency, current-mode synchronous DC/DC step-down converter that can deliver up to 3A output current over a wide input voltage range from 4.5V to 36V. This document explains the function and use of the RT2875B evaluation board (EVB) and provides information to enable operation and modification of the evaluation board and circuit to suit individual requirements.

Table of Contents

Purpose	1
Introduction.....	2
Application.....	2
Key Performance Summary Table.....	3
Bench Test Setup Conditions	3
Schematic, Bill of Materials & Board Layout	5
Step-Down Converter Efficiency Test	8
More Information.....	9
Important Notice for Richtek Evaluation Board	9

Introduction

General Product Description

The RT2875B is a high efficiency, current-mode synchronous DC/DC step-down converter that can deliver up to 3A output current over a wide input voltage range from 4.5V to 36V. The device integrates 95mΩ high-side and 70mΩ low-side MOSFETs to achieve high conversion efficiency. The current-mode control architecture supports fast transient response and simple external compensation. A cycle-by-cycle current limit function provides protection against shorted output and an external soft-start eliminates input current surge during start-up. The RT2875B provides complete protection functions such as input under-voltage lockout, output under-voltage protection, over-current protection and thermal shutdown. The RT2875B is available in the thermal enhanced TSSOP-14 (Exposed Pad) package.

The RT2875B provides Hiccup Mode Under Voltage Protection (UVP). When the V_{FB} voltage drops below 0.3V, the UVP function will be triggered to shut down switching operation. If the UVP condition remains for a period, the RT2875B will retry automatically. When the UVP condition is removed, the converter will resume operation. The UVP is disabled during soft-start period.

Product Features

- 3A Output Current
- Internal N-MOSFETs
- Current Mode Control
- Adjustable Switching Frequency : 300kHz to 2.1MHz
- Adjustable Current Limit : 1.5A to 6A
- Synchronous to External Clock : 300kHz to 2.1MHz
- Adjustable Output Voltage from 0.6V to 24V
- High Efficiency Up to 95%
- Stable with Low ESR Ceramic Output Capacitors
- Cycle-by-Cycle Current Limit
- Input Under-Voltage Lockout
- Output Under-Voltage Protection
- Thermal Shutdown
- RoHS Compliant and Halogen Free

Application

- Point of Load Regulator in Distributed Power Systems
- Digital Set Top Boxes
- Broadband Communications

Key Performance Summary Table

Key Features	Evaluation Board Number : PCB013_V1
Default Input Voltage	12V
Max Output Current	3A
Default Output Voltage	3.3V
Default Marking & Package Type	RT2875BQGCP, TSSOP-14 (Exposed Pad)
Operation Frequency	300kHz to 2.1MHz (Adjusted by RT Value, Default RT = 100k, Frequency = 500kHz)

Bench Test Setup Conditions

Headers Description and Placement

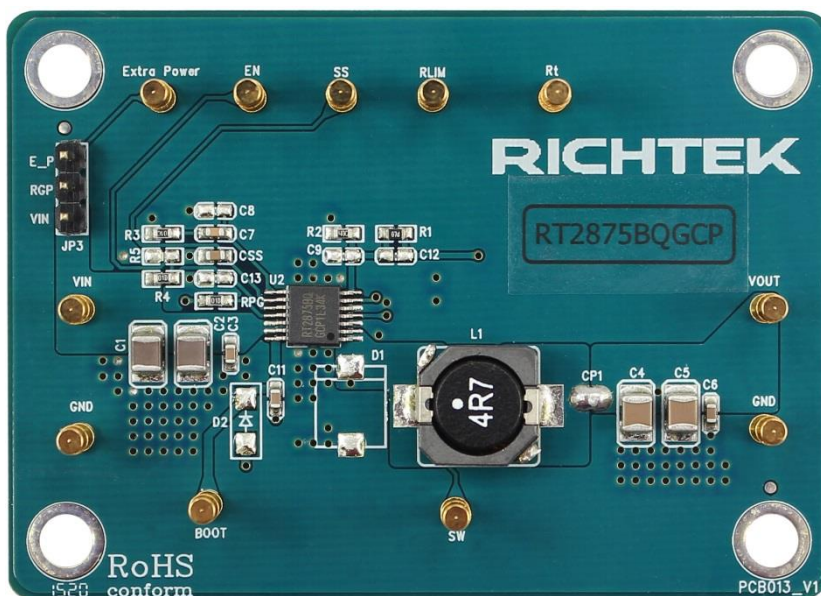

Please carefully inspect the EVB IC and external components, comparing them to the following Bill of Materials, to ensure that all components are installed and undamaged. If any components are missing or damaged during transportation, please contact the distributor or send e-mail to evb_service@richtek.com

Test Points

The EVB is provided with the test points and pin names listed in the table below.

Test point/ Pin name	Signal	Comment (expected waveforms or voltage levels on test points)
SW	Switch Node	Connect to external L-C filter.
PGND	Power Ground	Ground. The exposed pad must be soldered to a large PCB and connected to PGND for maximum power dissipation.
RT/SYNC	Oscillator Resistor	Oscillator Resistor and External Frequency Synchronization Input. Must connect a resistor from this pin to GND to set the switching frequency. If SYNC clock is requested, connect an external clock to change the switching frequency.
AGND	Analog Ground	Ground.
RLIM	Current Limit Setting	Connect a resistor from this pin to GND to set the current limit value.
FB	Feedback Voltage Input	The pin is used to set the output voltage of the converter to regulate to the desired via a resistive divider. Feedback reference = 0.6V.
COMP	Compensation Node.	COMP is used to compensate the regulation control loop. Connect a series RC network from COMP to GND. In some cases, an additional capacitor from COMP to GND is required.
SS	Soft-Start Time Setting.	Connect a capacitor from SS to GND to set the soft-start period.
EN	Enable	Enable Control Input. High = Enable.
PGOOD	Power Good Output.	Power Good Indicator Output.
VIN	Input Voltage	Input voltage range = 4.5V to 36V.
BOOT	Boot	Bootstrap Supply for High-Side Gate Driver. Connect a 0.1µF ceramic capacitor between the BOOT and SW pins.

Power-up & Measurement Procedure

1. Connect input power ($4.5V < V_{IN} < 36V$) and input ground to VIN and GND pins respectively.
2. Connect positive end and negative end of load to VOUT and GND of output pins respectively.
3. The output voltage of (V_{OUT}) can be set by R1 and R2.

$$V_{OUT} = V_{REF} * (1 + R1 / R2)$$

where $V_{REF} = 0.6V$ (typ.)

Specification

Parameter	Symbol	Min	Typ.	Max	Units
Input Voltage Range	V_{IN}	4.5		36	V
Oscillator Frequency	fosc	300		2100	kHz
Output Current	I _{OUT}		3		A
EN Input Voltage	V_{EN}	1.4	1.5	1.6	V

Schematic, Bill of Materials & Board Layout

EVB Schematic Diagram

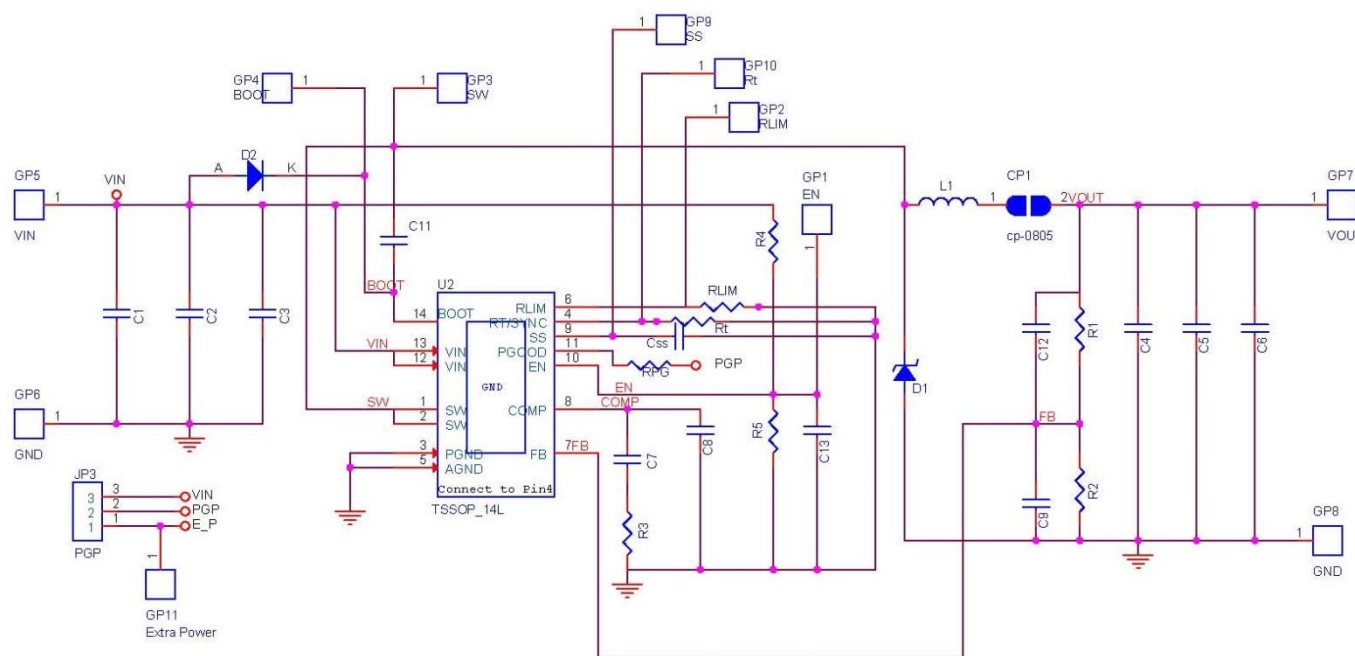

Bill of Materials

Reference	Q'ty	Part Number	Description	Package	Manufacture
U2	1	RT2875BQGCP	Step-down Converter	PTSSOP-14	RICHTEK
Css, C3, C6, C11	4	C1608X7R1H104KT000N	0.1μF/50V/X7R	C-0603	TDK
C1, C2	2	GRM32ER71H106KA12	10μF/50V/X7R	C-1210	Murata
C4, C5	2	GRM32ER61C226KE20L	22μF/16V/X5R	C-1210	MURATA
C7	1	0603B333K500	3.3nF/50V/X7R	C-0603	WALSIN
R5, C8, C9, C12, C13	5		NC	C/R-0603	
D1	0		NC		
D2	0		NC		
L1	1	744 771 404 7	4.7μH/7A		WE
RT, R4, RPG	3		100K	R-0603	
RLIM	1		33k	R-0603	
R1	1		115K	R-0603	
R2	1		25.5K	R-0603	
R3	1		10K	R-0603	

PCB Layout

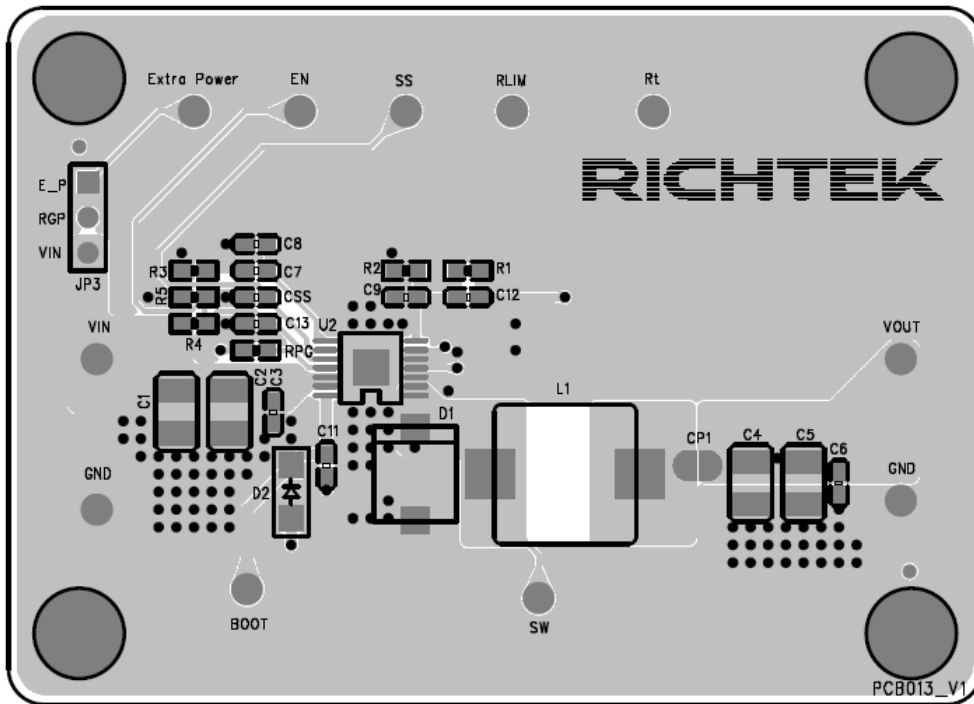

Top View (1st layer)

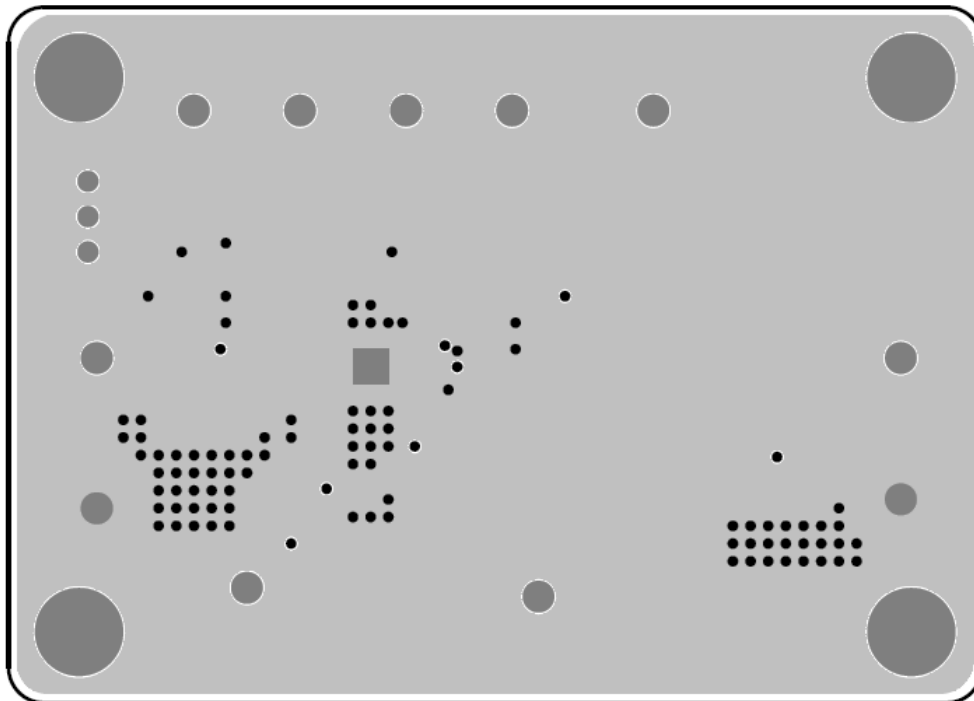

PCB Layout—Inner Side (2nd Layer)

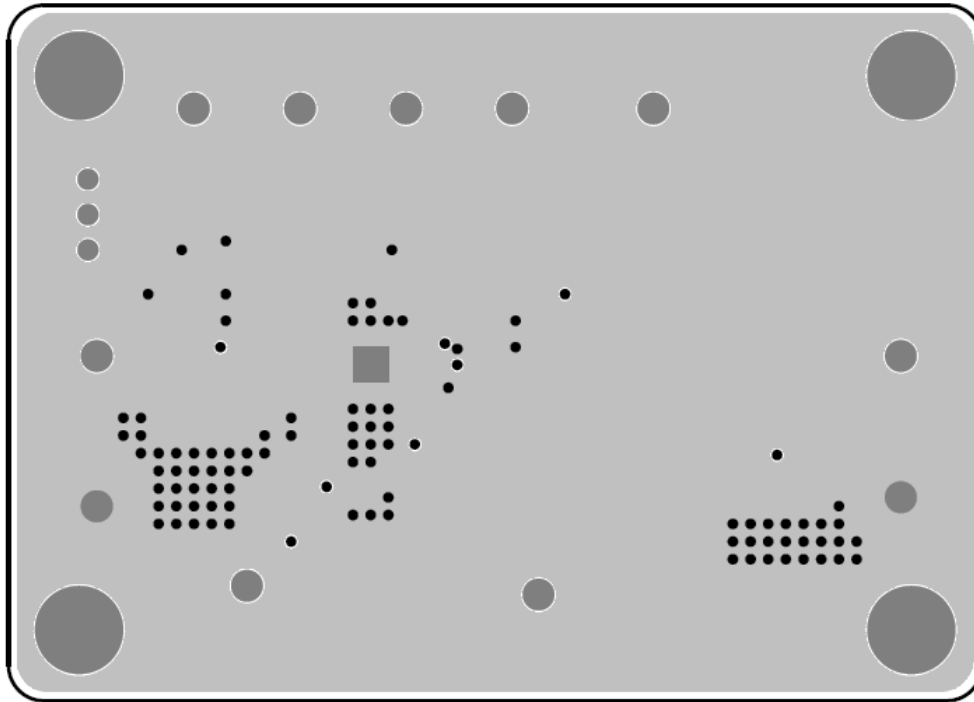

PCB Layout—Inner Side (3rd Layer)

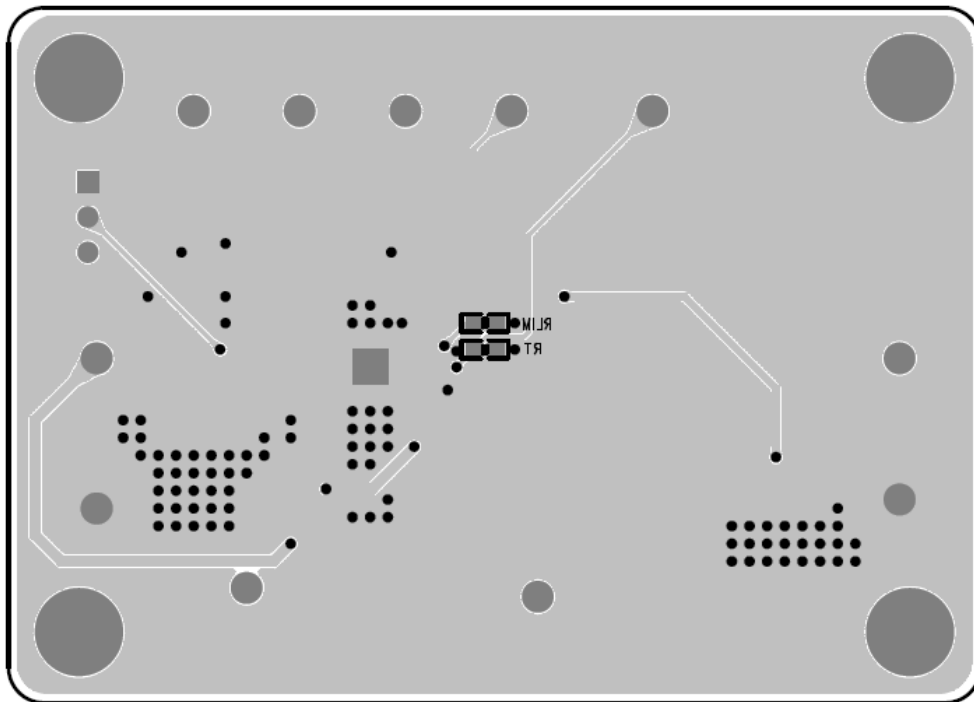

Bottom View (4th Layer)

Step-Down Converter Efficiency Test

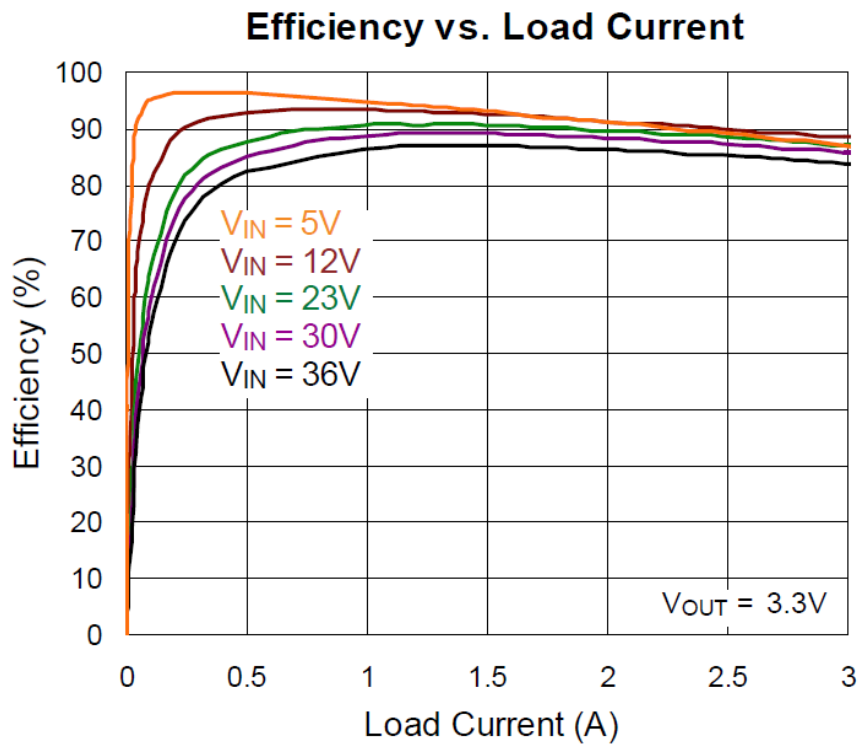

More Information

For more information, please find the related datasheet or application notes from Richtek website <http://www.richtek.com>.

Important Notice for Richtek Evaluation Board

THIS DOCUMENT IS FOR REFERENCE ONLY, NOTHING CONTAINED IN THIS DOCUMENT SHALL BE CONSTRUED AS RICHTEK'S WARRANTY, EXPRESS OR IMPLIED, UNDER CONTRACT, TORT OR STATUTORY, WITH RESPECT TO THE PRESENTATION HEREIN. IN NO EVENT SHALL RICHTEK BE LIABLE TO BUYER OR USER FOR ANY AND ALL DAMAGES INCLUDING WITHOUT LIMITATION TO DIRECT, INDIRECT, SPECIAL, PUNITIVE OR CONSEQUENTIAL DAMAGES.