

The logo for solo, featuring a stylized green swoosh to the left of the word "solo" in a blue, sans-serif font.

Ultra compact 500W and 1000W single output power supplies

- *High Efficiency*
- *Convection Cooled*
- *Digital Communications*



Ultra-high efficiency 1U size

FEATURES

- Single output: 24V or 48V
- EN60950 2nd Edition & EN60601-1 2nd and 3rd Edition
- Ultra high efficiency, >92%
- Low profile: 1U height (40mm)
- Convection Cooled 500W
- Fan Cooled 1000W (variable speed fan)
- 12V/300mA bias standby voltage provided
- Remote ON/OFF Signal
- Power Good Signal
- MIL810G
- 2 MOPP
- SEMI F47 Compliant
- BF Rated
- Optional I²C PMBus™ Communications
- Optional OR-ing Function
- 5 Year Warranty
- Adjustable output voltage
- Product Options: Conformal Coating, Low Leakage Current and Ruggedised

APPLICATIONS INCLUDE

- Industrial
- Test & Measurement
- Medical
- Hi-Rel COTS
- Communication

The Xsolo family of single output power supplies provides up to an incredible 1008W in an extremely compact package.

Available in two package types, the high efficiency Xsolo delivers an incredible **convection cooled 504W** in an open-frame U-channel form factor and up to **1008W in an enclosed, fan cooled chassis**.

The Xsolo platform comes with a host of features including: variable speed fan, 12V/300mA isolated bias supply, remote ON/OFF, output voltage control and parallel operation for higher power applications. Nominal output voltages are 24V and 48V with wide adjustment ranges and user defined set-points. Xsolo carries **dual safety certification, EN60950 2nd Edition** for Industrial Applications and **EN60601-1 2nd and 3rd Edition** for Medical Applications, meeting the stringent creepage and clearance requirements, 4KVAC isolation and <300uA leakage current. Xsolo is designed to meet **MIL810G** and is also compliant with **SEMI F47** for voltage dips and interruptions as well as being compliant with all relevant EMC emission and immunity standards.

Optional features include I²C digital communications and OR-ing Function for N+1 redundancy. The product can also be conformal coated and ruggedised for use in harsh environments. With convection cooled power capability of over 500W, the Xsolo is ideal for use in a wide range of applications: industrial, Hi-Rel MIL-COTS applications, as well as acoustically sensitive laboratory and medical environments.



XS Models

	Model	Power (W)	Output Voltage	Output Current (A)	Medical Approval UL/EN60601-1 3rd edition	Industrial Approval UL/EN60950 2nd edition
XS	XS500-24	504	24	21.0	Yes	Yes
	XS1000-24	1008	24	42.0	Yes	Yes
	XS500-48	504	48	10.5	Yes	Yes
	XS1000-48	1008	48	21.0	Yes	Yes

	Model	Vnom (V)	Power (W)	Description	Set Point Adjust Range (V)	Dynamic Vtrim Range (V)	I _{max} (A)	Remote Sense	Power Good
XS	XS500-24	24	504	Convection Cooled U-Channel	19-28	14-28	21.0	Yes	Yes
	XS1000-24	24	1008	Enclosed Fan Cooled	19-28	14-28	42.0	Yes	Yes
	XS500-48	48	504	Convection Cooled U-Channel	36-58	29-58	10.5	Yes	Yes
	XS1000-48	48	1008	Enclosed Fan Cooled	36-58	29-58	21.0	Yes	Yes

*Full part numbering information including product options and ordering information on page 5.

INPUT					
Parameter	Conditions/Description	Min	Nom	Max	Units
Input Voltage Range	Universal Input 47-440Hz	85 120		264 380	VAC VDC
Power Rating	XS500 XS1000		504 1008		W W
Input Current	XS500 XS1000		5 10		A A
Inrush Current	230VAC @ 25°C			25	A
Undervoltage Lockout	Shutdown	65		74	VAC
Fusing	XS500 250VAC XS1000 250VAC		F8A HRC F12A HRC		
OUTPUT					
Parameter	Conditions/Description	Min	Nom	Max	Units
Output Voltage Range	XS500/1000-24: Multi-turn potentiometer XS500/1000-24: Dynamic Vtrim range XS500/1000-48: Multi-turn potentiometer XS500/1000-48: Dynamic Vtrim range	19 14 36 29		28 28 58 58	VDC VDC VDC VDC
Output Current Range	XS500-24 XS1000-24 XS500-48 XS1000-48			21 42 10.5 21	A A A A
Load & Cross Regulation	For 25% to 75% load change (± 0.4 % for ORing option)			± 0.2	%
Transient Response	For 25% to 75% load change Voltage Deviation Settling Time			2.5 500	% μ s
Ripple and Noise	XS500/1000-24: 20MHz XS500/1000-48: 20MHz		240 480		mV pk-pk mV pk-pk
Overvoltage Protection	XS500/1000-24: Latching XS500/1000-48: Latching	33 61	34 63	37 69	VDC VDC
Overcurrent Protection	Straight line with hiccup activation at $<30\%$ of Vnom.	105	115	130	%
Line Regulation	For $\pm 10\%$ change from nominal line		± 0.5		%
Remote Sense				0.5	VDC
Overshoot				2	%
Rise Time	Monotonic		3	5	ms
Turn-on Delay	From AC in From Remote On/Off		500 10	800	ms ms
Hold-up Time	For nominal output voltages at full load.	17			ms
GENERAL					
Parameter	Conditions/Description	Min	Nom	Max	Units
Isolation Voltage	Input to Output Input to Chassis Output to Chassis	4000 1500 1500			VAC VAC VDC
Efficiency	230VAC, 1008W @ 24V/48V		>92		%
Safety Agency Approvals	EN60601-1 2nd and 3rd Edition, cTUVus 60601-1 EN60950 2nd Edition, cTUVus 60950				
Leakage Current	264VAC, 60Hz, 25°C 264VAC, 60Hz, 25°C (Option 4)			300 150	μ A μ A
Signals	See Page 3				
Bias Supply	Always on, current 300mA		12.0		VDC
Weight	XS500 XS1000		1.1 1.3		Kg Kg
MTBF	Telecordia SR-332, 40°C ground benign, parts count.			550,000	Hours
EMC					
Parameter	Standard	Level		Units	
Emissions					
Conducted	EN55011, EN55022, FCC		Class B		
Radiated	EN55011, EN55022, FCC		Class B		
Harmonic Distortion	EN61000-3-2 Class A		Compliant		
Flicker & Fluctuation	EN61000-3-3		Compliant		
Immunity					
Electrostatic Discharge	EN61000-4-2		Level 2		
Radiated Immunity	EN61000-4-3		Level 3		
Fast Transients-Burst	EN61000-4-4		Level 3		
Input Line Surges	EN61000-4-5		Level 3		
Conducted Immunity	EN61000-4-6		Level 3		
Voltage Dips	EN61000-4-11, SEMI F47 Compliant. ⁽¹⁾		Compliant		
ENVIRONMENTAL					
Parameter	Conditions/Description	Min	Nom	Max	Units
Operating Temperature		-40		+70	°C
Storage Temperature		-40		+85	°C
Derating	See Page 4 for full temperature deratings				
Relative Humidity	Non-condensing	5		95	%RH
Shock and Vibration	Designed to meet MIL810G ⁽²⁾		55		G
Altitude	Operational: 3000m, Storage: 8000m				m

Note 1. SEMI F47 compliant at input voltages >160 VAC. Consult Excelsys for details.

Note 2. Consult Excelsys for HALT report.

Note 3. System design with low leakage capacitors requires particular attention to EMI. Please consult Excelsys for application details.

Note 4. Contact sales@excelsys.com for details including MOQs on alternative preset output voltages.

Note 5. The specifications contained herein are believed to be correct at time of publication and are subject to change without notice.

Note 6. All specifications at nominal input, full load, 25°C unless otherwise stated.

Note 7. Compliance with MIL-STD-461 (CE101 & CE102) achieved with the addition of an external line filter from LCR p/n F19374.

Connectors

Input Connector J7

Connector, Barrier Terminal Block, Vertical, 3 position, Pitch:0.375in
Molex - 38720-7503

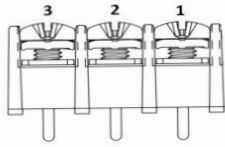

O/P Connector J10 and J12

Connector, Barrier STRIP DL 3CIRC .325
Tyco - 2-1437667-5

*Note maximum current per screw terminal is 20Amps.

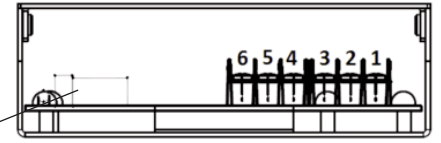
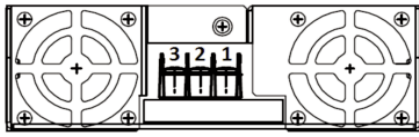
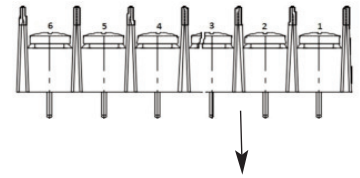

Output Signal Connector J5

Connector, Header 14POS 2MM Pitch T/H
Molex - 87831-1420

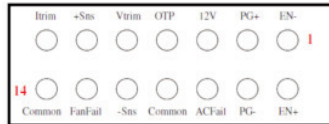

J5 Mating Connectors

Locking Molex 51110-1451; Non Locking 51110-1450;
Crimp Terminal: Molex p/n 50394

***I²C Interface (Option)**

The I²C PM Bus compatible interface can be used for monitoring the output voltage and current. It can also be used to manage real time data for the PSU.

For full details on PM Bus please contact sales@excelsys.com.

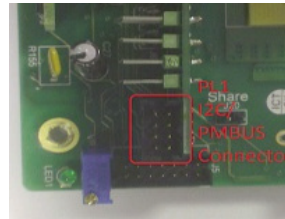

Connector Details

Pin	Input	Output	Signal	PMBus Connector
1	L	+Vo	EN-	ALERT
2	N	+Vo	EN+	SDA
3	E	+Vo	PG+	SCL
4		-Vo	PG-	PMB_Control
5		-Vo	12V	Not Used
6		-Vo	ACFail	Not Used
7			OTP	Not Used
8			Common	GND
9			Vtrim	
10			-Sns	
11			+Sns	
12			FanFail	
13			Itrim	
14			Common	

PMBus Connector:

PL1: Molex - 87833-0831

PL1 Mating Connector:

Locking Molex 51110-0860; Non Locking 51110-0850; Crimp Terminal: Molex p/n 50394

AC Fail Signal

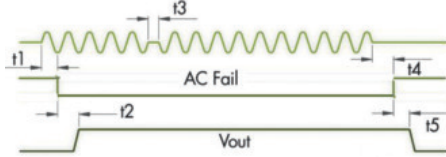

$80ms < t1 < 600ms$

$10ms < t2 < 20ms$

$t3 = 10ms$

$t4 > 10ms$

$t5 > 2ms$

AC Fail

AC Mains Fail signal is implemented by an Opto-isolated signal with a maximum sink current of 4mA. During normal operation the transistor is ON. When the input voltage is lost or goes below 80Vac, the opto-transistor is turned OFF at least 10mS before loss of output regulation (at nominal voltage or below).

Temperature Alarm

Open collector signal indicating that excessive temperature has been reached due to fan failure or operation beyond ratings. This signal is activated at least 10mS prior to system shutdown.

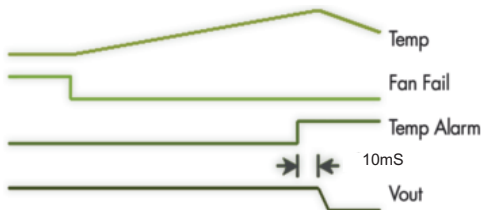

Fan Fail

Open collector signal indicating that at least one of the fans has failed. This does not cause power supply shutdown. The power supply will continue to operate until 10ms after the temperature alarm signal is generated.

*Fan Fail, Temperature Fail and AC Fail signal figures above assume use of a pull up resistor to a signal voltage

Paralleling Xsolo's

To achieve increased currents Xsolo products can be paralleled. To connect in parallel the outputs must be trimmed to within 5mV of each other and then the current share header J20 must be added to each Xsolo product.

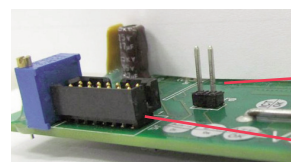

J20 (Attach jumper here)

Output Signal Connector J5

Section 5.2

Xsolo Derating Curves

Contact Excelsys for information on power rating with system fans and airflow.

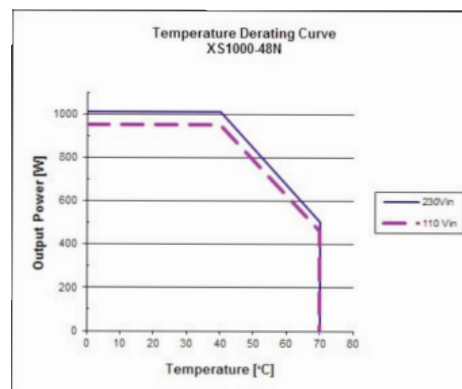
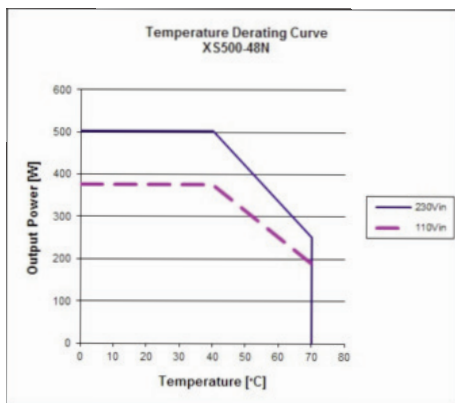
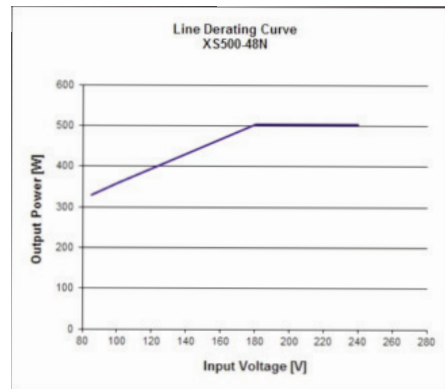
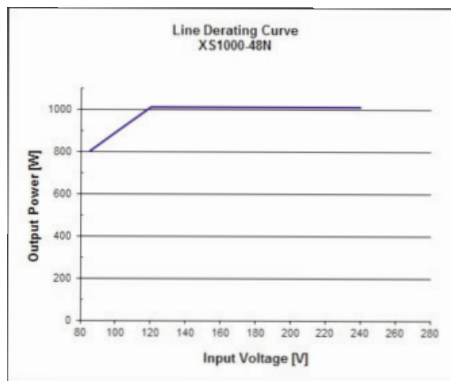
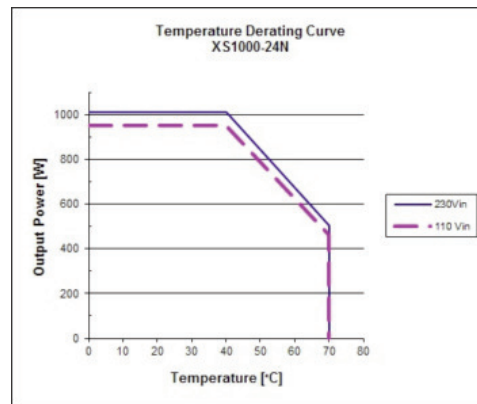
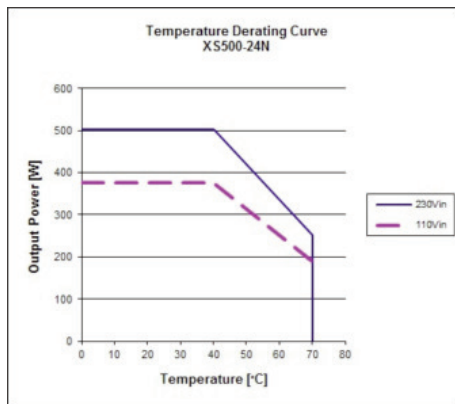
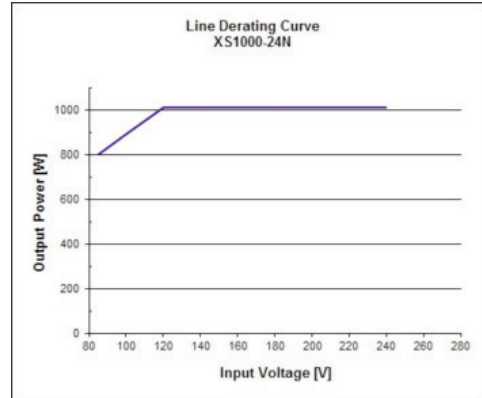
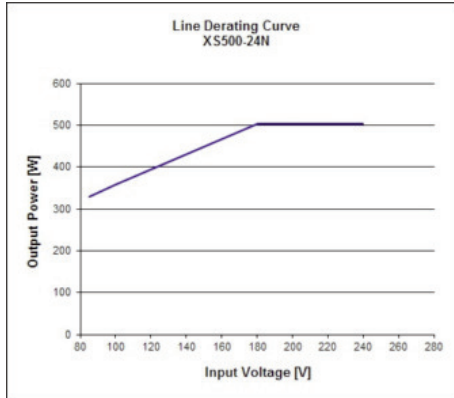

Configuring your Xsolo

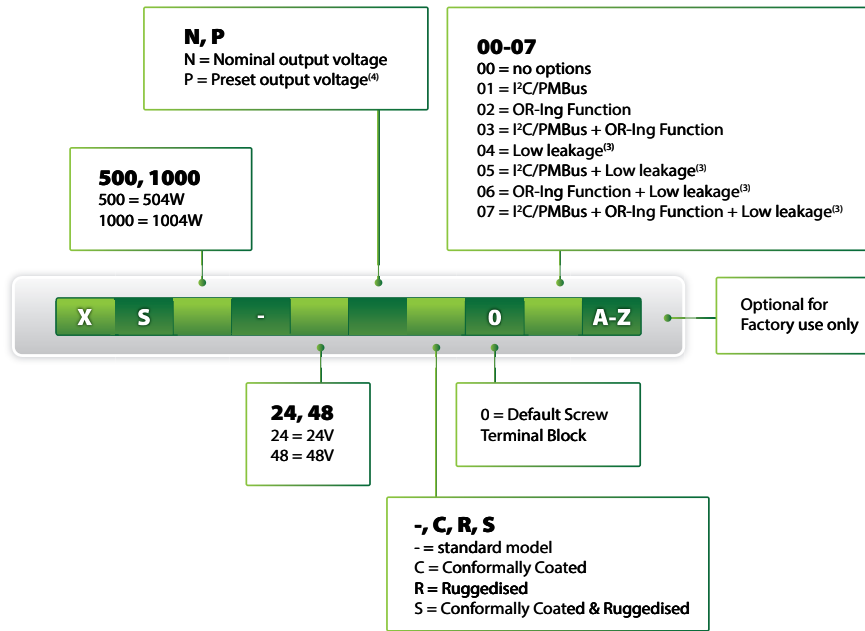

Example 1: XS1000-24N-000 = Xsolo 1000W, 24V output with no options

Example 2: XS1000-24N-003 = Xsolo 1000W, 24V output with I²C/PMBus and OR-Ing function.

Mechanical Drawings

XS500 Mechanical Specifications
(All dimensions in mm)

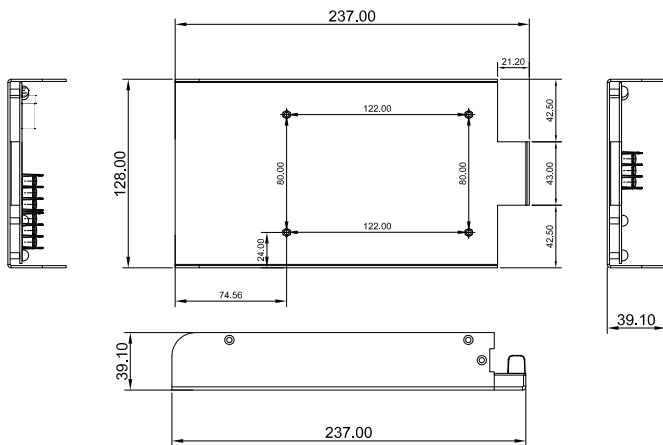
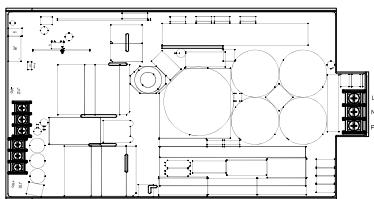

Mounting Holes
4 M3 threaded PEMS on Base. Max Screw Penetration is 6mm from Base

XS1000 Mechanical Specifications
(All dimensions in mm)

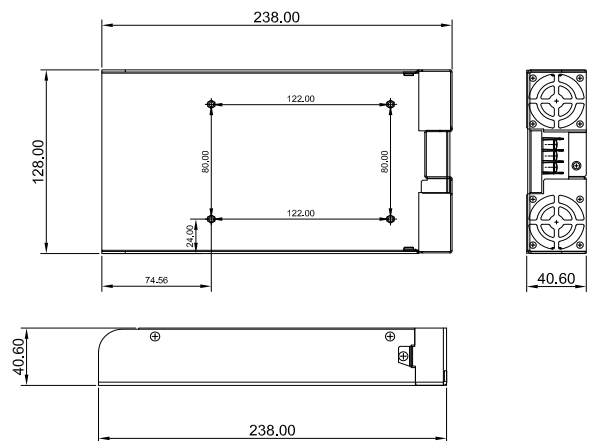
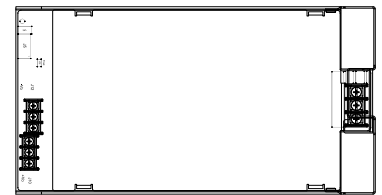

Mounting Holes
4 M3 threaded PEMS on Base. Max Screw Penetration is 6mm from Base