

PRODUCT NUMBER SEE SHEET 2

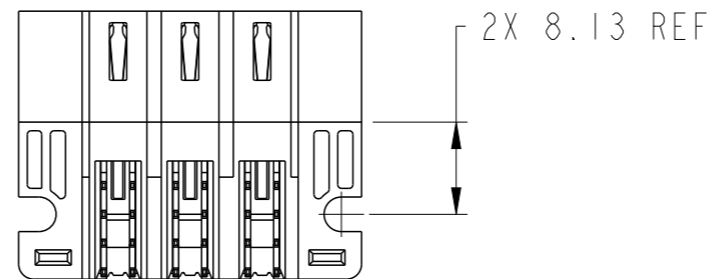

spec ref	*	dr	Eddy Zeng	2014/10/17	projection	MM	size	A3	scale	3:2
tolerance std	ASME Y14.5	eng	Eddy Zeng	2014/10/29			ecn no	-	rel level	Released
TOLERANCES UNLESS OTHERWISE SPECIFIED		chr	Li-He	2014/10/28						
surface		linear	0.X	±0.5		title 3ACP RA STB HEADER	dwg no 10106124-3000002	rev A	ASME Y14.5	
			0.XX	±0.25					www.fci.com	
			0.XXX	±0.10					cat. no.	
ASME Y14.5	angular	0°	±2°	Product - Customer Drw		sheet 1 of 3				

PRODUCT NO.	ROWS	HIGH POWER				
		E1	P1	P2	P3	E2
10106124-3000002LF	DCBA					

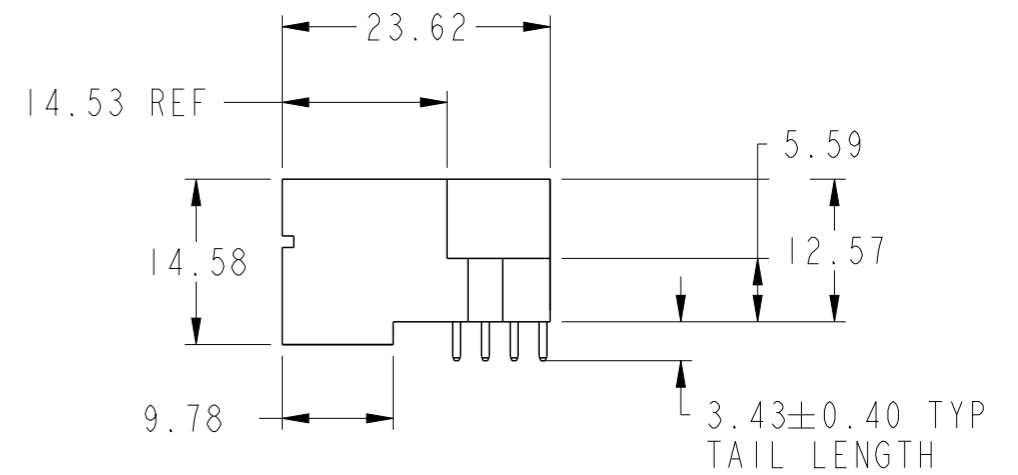
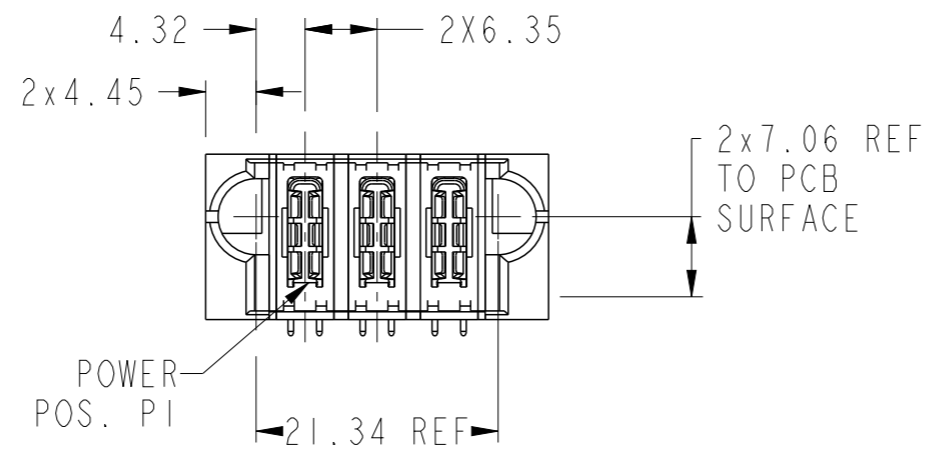
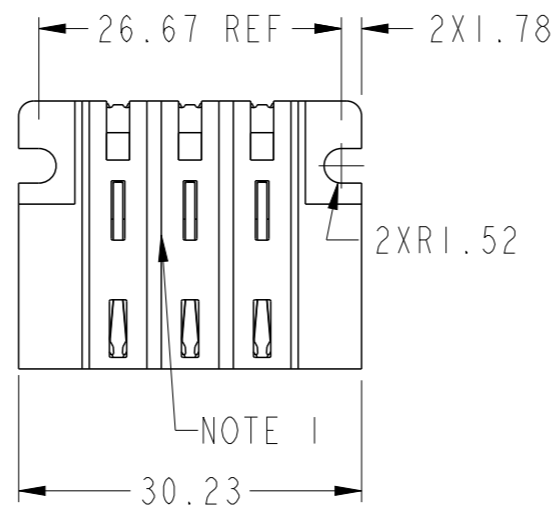
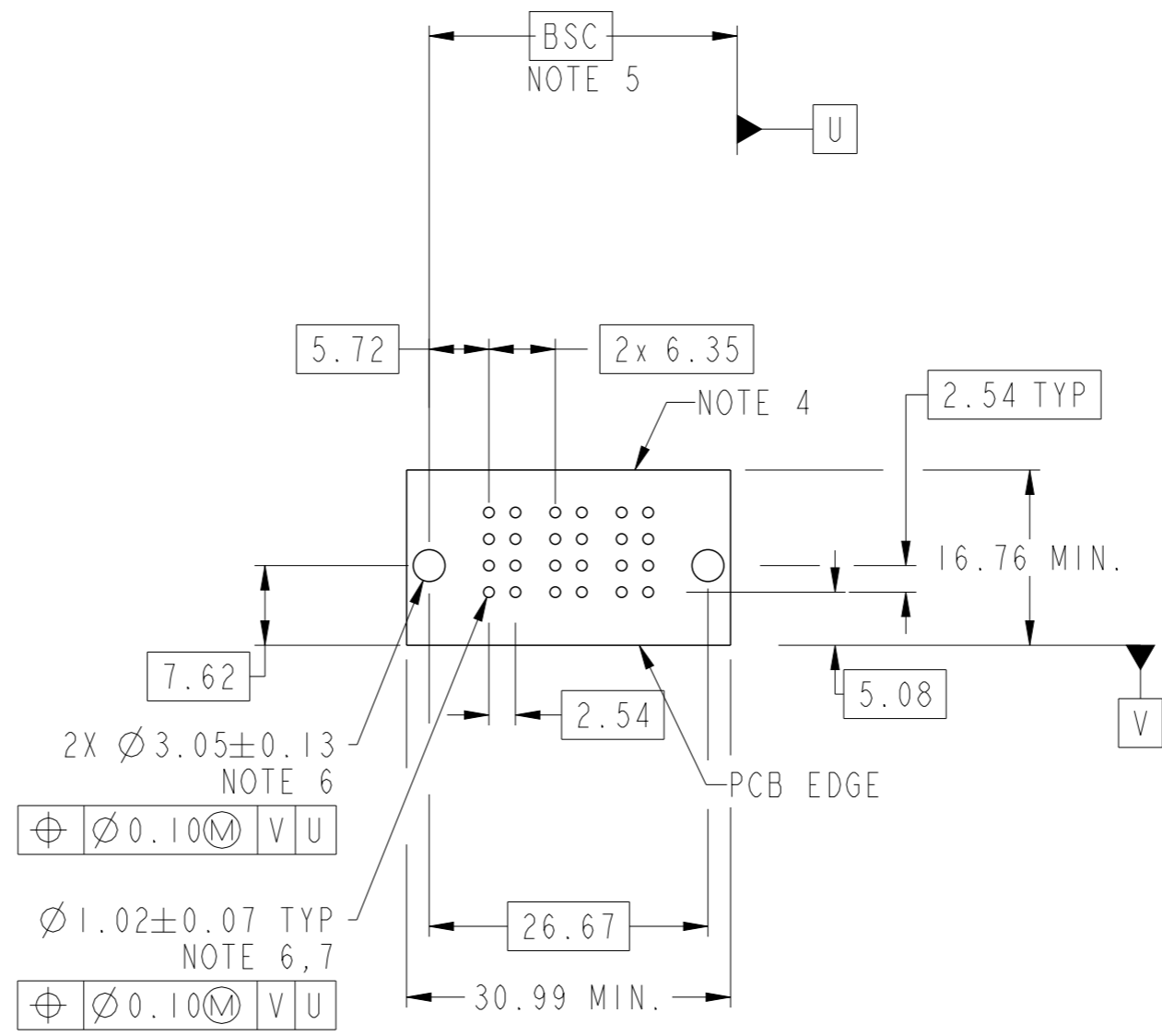

2X $\varnothing 3.05 \pm 0.13$
NOTE 6

$\oplus \varnothing 0.10 \text{ (M)} \text{ V U}$

$\varnothing 1.02 \pm 0.07$ TYP
NOTE 6, 7

$\oplus \varnothing 0.10 \text{ (M)} \text{ V U}$

CODE	DESCRIPTION
HI	STD HIGH POWER CONTACT (3.43)



dr	Eddy Zeng	2014/10/17	projection		MM	size	A3	scale	3:2
eng	Eddy Zeng	2014/10/29				ecn no	-		
chr	Li-He	2014/10/28				rel level	Released		
appr	Pei-Ming Zheng	2014/10/29	product family	PwrBlade+					
	title	3ACP		dwg no	10106124-3000002		rev	A	
www.fci.com	cat. no.			Product - Customer Drw			sheet 2 of 3		

NOTES:

- 1) "FCI", PART NUMBER AND DATE CODE TO BE MARKED ON THIS SURFACE.
THE P/N CAN BE OMITTED IF THERE IS NOT ENOUGH SPACE ON THIS SURFACE.
- 2) MATERIALS:
-HOUSING - GLASS FILLED WITH HIGH TEMP THERMOPLASTIC, UL94V-0.
-SIGNAL CONTACT - COPPER ALLOY.
-POWER CONTACT - HIGH CONDUCTIVITY COPPER ALLOY.
- 3) PLATING SPECIFICATION REFER TO FCI 10116351
- 4) DENOTES CONNECTOR KEEP OUT ZONE.
- 5) DATUM AND BASIC DIMENIONS WERE ESTABLISHED BY CUSTOMER.
- 6) ALL HOLE DIAMETERS ARE FINISHED HOLE SIZES.
- 7) 1.15 ± 0.025 MM DRILLED HOLE PLATED WITH 0.00762MM MIN Sn
OVER 0.0254-0.0762MM Cu PLATING TO ACHIEVE A 1.02 ± 0.07 MM HOLE.
- 8) PRODUCT SPECIFICATION REFER TO FCI GS-12-658.
APPLICATION SPECIFICATION REFER TO FCI GS-20-141.
PRODUCT PACKAGED IN TRAYS, REFER TO FCI GS-14-1502.

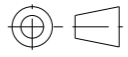
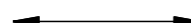

Copyright FCI.

dr	Eddy Zeng	2014/10/17	projection 	MM 	size	A3	scale	3:2
eng	Eddy Zeng	2014/10/29			ecn no	-		
chr	Li-He	2014/10/28			rel level	Released		
appr	Pei-Ming Zheng	2014/10/29	product family	PwrBlade+				
		title 4ACP RA STB HEADER		dwg no 10106124-3000002	rev A			
www.fci.com		cat. no.	Product - Customer Drw		sheet 3 of 3			