

40mm sq.

San Ace 40



General Specifications

- Material Frame: Plastics (Flammability: UL94V-0),
Impeller: Plastics (Flammability: UL94V-1)
- Expected Life Refer to specifications (L10:Survival rate:90% at 60°C ,
rated voltage, and continuously run in a free air state)
- Lead Wire ⊕red ⊖black or blue (Sensor) yellow
- Storage Temperature -30°C to +70°C (Non-condensing)

40×40×20mm (Mass : 45g) **9P** type

Specifications

The following nos. **have pulse sensors and ribs.**

| Model No. | Rated Voltage [V] | Operating Voltage Range [V] | Rated Current [A] | Rated Input [W] | Rated Speed [min ⁻¹] | Max. Airflow [m ³ /min] [CFM] | Max. Static Pressure [Pa] [inchH ₂ O] | SPL [dB(A)] | Operating Temperature [°C] | Expected Life [h] |
|--------------|-------------------|-----------------------------|-------------------|-----------------|----------------------------------|--|--|-------------|----------------------------|-------------------|
| 109P0405J601 | 5 | 4.5 to 5.5 | 0.46 | 2.3 | 9,800 | 0.28 9.9 | 98.5 0.396 | 39 | -20 to +70 | 40,000/60°C |
| 109P0405H601 | | | 0.32 | 1.6 | 8,000 | 0.225 8.0 | 65.7 0.264 | 33 | | |
| 109P0405F601 | | | 0.25 | 1.25 | 6,500 | 0.183 6.5 | 45.1 0.181 | 28 | | 60,000/60°C |
| 109P0405M601 | | | 0.12 | 0.60 | 5,000 | 0.136 4.8 | 26.5 0.106 | 24 | | |
| 109P0412G601 | 12 | 7 to 13.8 | 0.28 | 3.36 | 12,500 | 0.35 12.4 | 153.8 0.618 | 44 | -20 to +60 | 40,000/60°C |
| 109P0412D601 | | | 0.18 | 2.16 | 11,000 | 0.31 10.9 | 124 0.498 | 42 | | |
| 109P0412E601 | | | 0.13 | 1.8 | 9,200 | 0.26 9.2 | 87.3 0.351 | 37 | -20 to +70 | 60,000/60°C |
| 109P0412H601 | | | 0.11 | 1.32 | 8,000 | 0.225 8.0 | 65.7 0.264 | 33 | | |
| 109P0412F601 | | | 0.09 | 1.08 | 6,500 | 0.183 6.5 | 45.1 0.181 | 28 | | |
| 109P0412M601 | | | 0.06 | 0.72 | 5,000 | 0.136 4.8 | 26.5 0.106 | 24 | | |
| 109P0424G601 | 24 | 12 to 27.6 | 0.15 | 3.6 | 12,500 | 0.35 12.4 | 153.8 0.618 | 44 | -20 to +60 | 40,000/60°C |
| 109P0424D601 | | 12 to 27.6 | 0.13 | 3.12 | 11,000 | 0.31 10.9 | 124 0.498 | 42 | | |
| 109P0424H601 | | 12 to 27.6 | 0.07 | 1.68 | 8,300 | 0.233 8.2 | 69.6 0.280 | 35 | -20 to +70 | 60,000/60°C |
| 109P0424F601 | | 14 to 27.6 | 0.06 | 1.44 | 6,500 | 0.183 6.5 | 45.1 0.181 | 28 | | |
| 109P0424B601 | | 20.4 to 27.6 | 0.06 | 1.44 | 5,200 | 0.14 4.9 | 28.3 0.114 | 25 | | |

Other sensor specifications are available as options. Please refer to the index (pp. 496 to 497).

Dimensions (unit: mm)

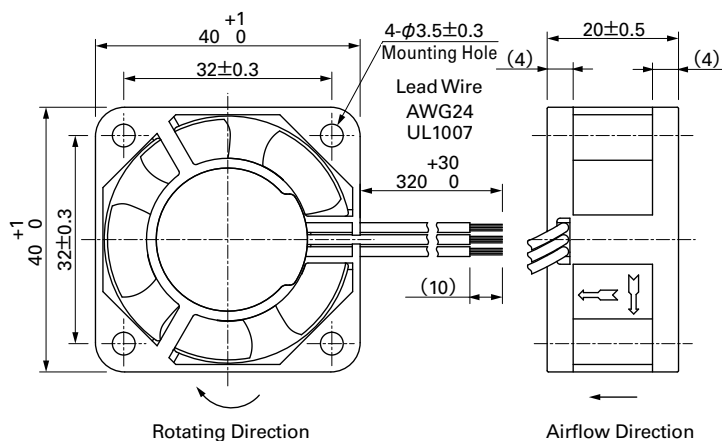

■ Reference Dimensions of Mounting Holes and Vent Opening (unit: mm)

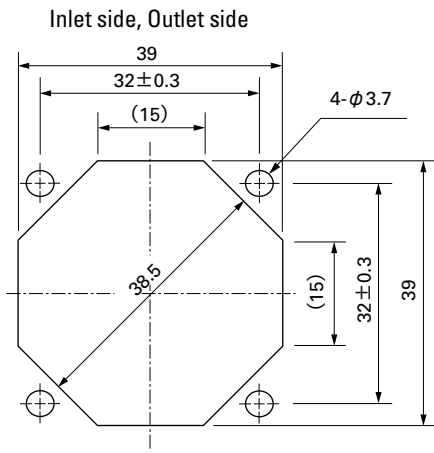

■ Options (unit: mm)

Finger Guards

Model : 109-059 Surface treatment : Nickel-chrome plating (silver) Color
 : 109-059H : Cation electropainting (black)

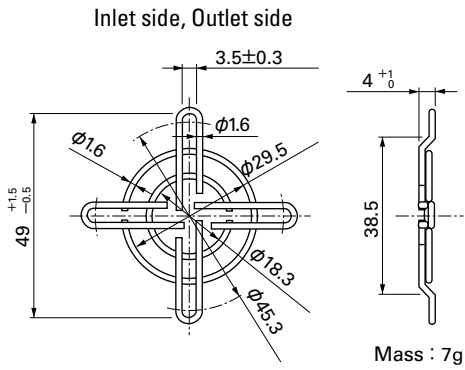

40 mm sq.

San Ace 40

40×40×20mm [Mass : 45g]

Airflow - Static Pressure Characteristics

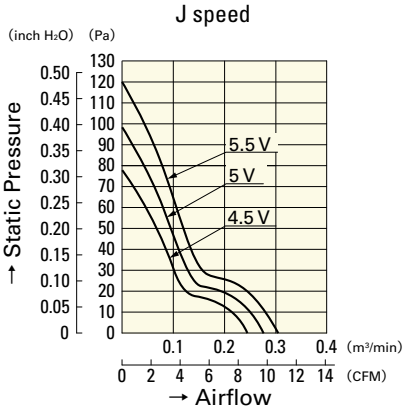

109P0405J601

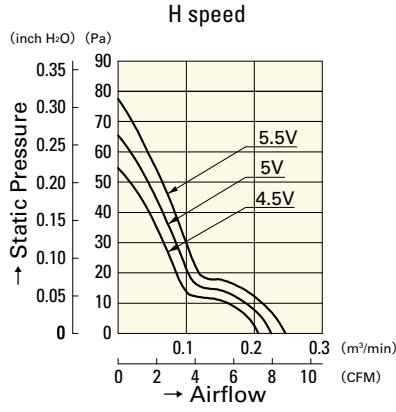

109P0405H601

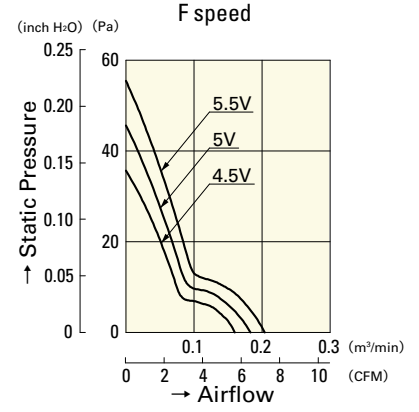

109P0405F601

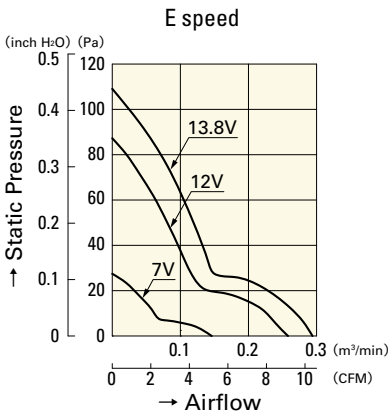

109P0412E601

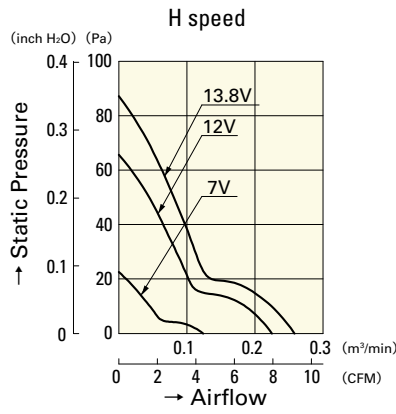

109P0412H601

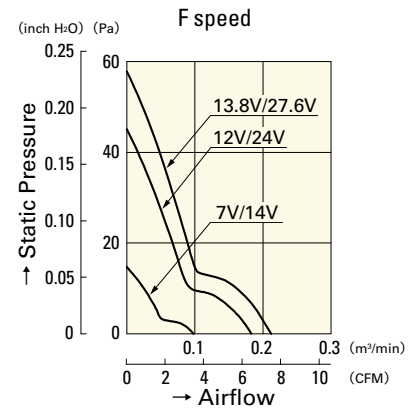

109P0412F601
109P0424F601

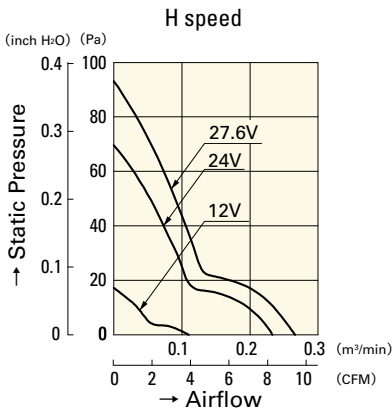

109P0424H601

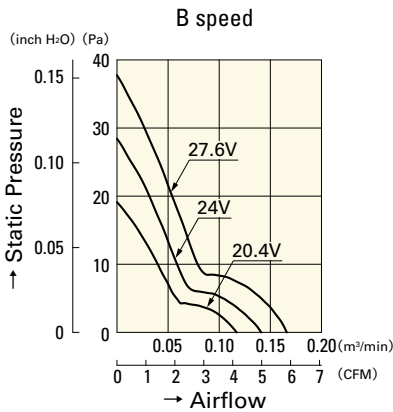

109P0424B601

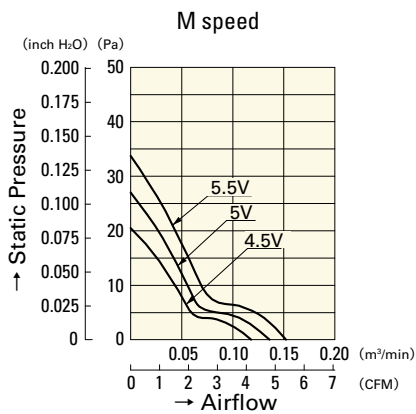

109P0405M601

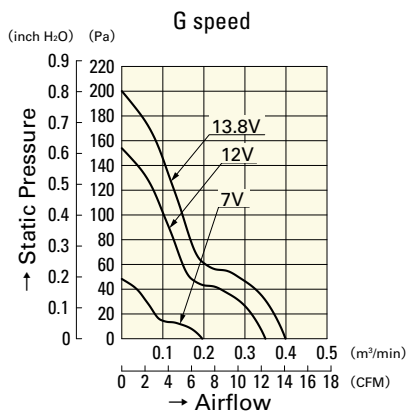

109P0412G601

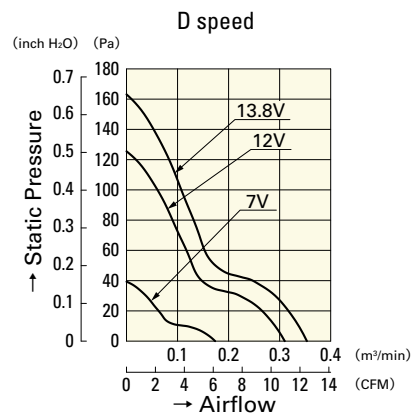

109P0412D601

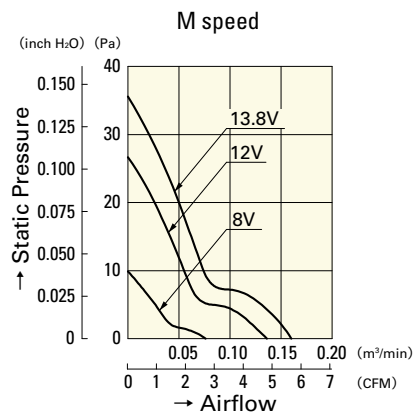

109P0412M601

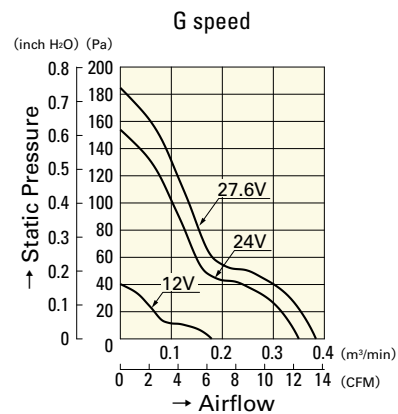

109P0424G601

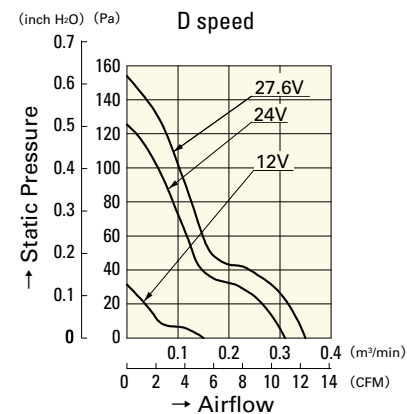

109P0424D601