

Important notice

Dear Customer,

On 7 February 2017 the former NXP Standard Product business became a new company with the tradename **Nexperia**. Nexperia is an industry leading supplier of Discrete, Logic and PowerMOS semiconductors with its focus on the automotive, industrial, computing, consumer and wearable application markets

In data sheets and application notes which still contain NXP or Philips Semiconductors references, use the references to Nexperia, as shown below.

Instead of <http://www.nxp.com>, <http://www.philips.com/> or <http://www.semiconductors.philips.com/>, use <http://www.nexperia.com>

Instead of sales.addresses@www.nxp.com or sales.addresses@www.semiconductors.philips.com, use salesaddresses@nexperia.com (email)

Replace the copyright notice at the bottom of each page or elsewhere in the document, depending on the version, as shown below:

- © NXP N.V. (year). All rights reserved or © Koninklijke Philips Electronics N.V. (year). All rights reserved

Should be replaced with:

- © **Nexperia B.V. (year). All rights reserved.**

If you have any questions related to the data sheet, please contact our nearest sales office via e-mail or telephone (details via salesaddresses@nexperia.com). Thank you for your cooperation and understanding,

Kind regards,

Team Nexperia

DATA SHEET

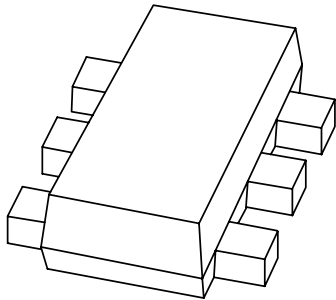

PEFM21 12 V PNP loadswitch

Product data sheet

2004 Jan 12

12 V PNP loadswitch

PEMF21

FEATURES

- Low V_{CEsat} transistor and resistor-equipped transistor in one package
- Very small 1.6 × 1.2 mm ultra thin package
- Reduced component count.

APPLICATIONS

- Line switches
- Battery charger switches
- Power supply switches
- Drive switches
- General purpose analog switches.

DESCRIPTION

Low V_{CEsat} PNP transistor and NPN resistor-equipped transistor in a SOT666 plastic package (see "Ordering information" for package details).

MARKING

TYPE NUMBER	MARKING CODE
PEMF21	2F

QUICK REFERENCE DATA

SYMBOL	PARAMETER	TYP.	MAX.	UNIT
TR1; PNP; low V_{CEsat} transistor				
V_{CEO}	collector-emitter voltage	–	–12	V
I_C	collector current (DC)	–	–500	mA
R_{CEsat}	equivalent on-resistance	–	500	m Ω
TR2; NPN; resistor-equipped transistor				
V_{CEO}	collector-emitter voltage	–	50	V
I_O	output current (DC)	–	100	mA
R1	bias resistor	10	–	k Ω
R2	bias resistor	10	–	k Ω

PINNING

PIN	DESCRIPTION
1	emitter TR1
2	base TR1
3	collector TR2
4	emitter TR2
5	base TR2
6	collector TR1

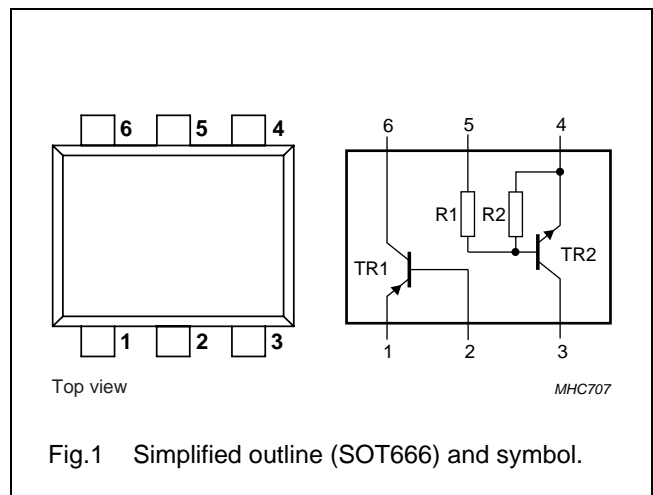

ORDERING INFORMATION

TYPE NUMBER	PACKAGE		
	NAME	DESCRIPTION	VERSION
PEMF21	–	plastic surface mounted package; 6 leads	SOT666

12 V PNP loadswitch

PEMF21

LIMITING VALUES

In accordance with the Absolute Maximum Rating System (IEC 60134).

SYMBOL	PARAMETER	CONDITIONS	MIN.	MAX.	UNIT
Transistor TR1					
V _{CBO}	collector-base voltage	open emitter	–	–15	V
V _{CEO}	collector-emitter voltage	open base	–	–12	V
V _{EBO}	emitter-base voltage	open collector	–	–6	V
I _C	collector current (DC)		–	–500	mA
I _{CM}	peak collector current		–	–1	A
I _{BM}	peak base current		–	–100	mA
P _{tot}	total power dissipation	T _{amb} = 25 °C; note 1	–	200	mW
Transistor TR2					
V _{CBO}	collector-base voltage	open emitter	–	50	V
V _{CEO}	collector-emitter voltage	open base	–	50	V
V _{EBO}	emitter-base voltage	open collector	–	10	V
V _i	input voltage positive negative		–	+40	V
			–	–10	V
I _O	output current (DC)		–	100	mA
I _{CM}	peak collector current		–	100	mA
P _{tot}	total power dissipation	T _{amb} = 25 °C; note 1	–	200	mW
Per device					
P _{tot}	total power dissipation	T _{amb} = 25 °C; note 1	–	300	mW
T _{stg}	storage temperature		–65	+150	°C
T _j	junction temperature		–	150	°C
T _{amb}	operating ambient temperature		–65	+150	°C

Note

1. Transistor mounted on an FR4 printed-circuit board.

THERMAL CHARACTERISTICS

SYMBOL	PARAMETER	CONDITIONS	VALUE	UNIT
Per device				
R _{th(j-a)}	thermal resistance from junction to ambient	notes 1 and 2	416	K/W

Notes

1. Transistor mounted on an FR4 printed-circuit board.
2. Reflow soldering is the only recommended soldering method.

12 V PNP loadswitch

PEMF21

CHARACTERISTICS

$T_{amb} = 25\text{ °C}$ unless otherwise specified.

SYMBOL	PARAMETER	CONDITIONS	MIN.	TYP.	MAX.	UNIT
Transistor TR1						
I_{CBO}	collector-base cut-off current	$V_{CB} = -15\text{ V}; I_E = 0$	–	–	–100	nA
I_{EBO}	emitter-base cut-off current	$V_{EB} = -5\text{ V}; I_C = 0$	–	–	–100	nA
h_{FE}	DC current gain	$V_{CE} = -2\text{ V}; I_C = -10\text{ mA}$	200	–	–	
V_{CEsat}	collector-emitter saturation voltage	$I_C = -200\text{ mA}; I_B = -10\text{ mA}$	–	–	–250	mV
R_{CEsat}	equivalent on-resistance	$I_C = -500\text{ mA}; I_B = -50\text{ mA}; \text{note 1}$	–	300	500	m Ω
V_{BEsat}	base-emitter saturation voltage	$I_C = -500\text{ mA}; I_B = -50\text{ mA}; \text{note 1}$	–	–	–1.1	V
V_{BEon}	base-emitter turn-on voltage	$V_{CE} = -2\text{ V}; I_C = -100\text{ mA}; \text{note 1}$	–	–	–0.9	V
f_T	transition frequency	$I_C = -100\text{ mA}; V_{CE} = -5\text{ V}; f = 100\text{ MHz}$	100	280	–	MHz
C_c	collector capacitance	$V_{CB} = -10\text{ V}; I_E = i_e = 0; f = 1\text{ MHz}$	–	–	10	pF
Transistor TR2						
I_{CBO}	collector-base cut-off current	$V_{CB} = 50\text{ V}; I_E = 0$	–	–	100	nA
I_{CEO}	collector-emitter cut-off current	$V_{CE} = 30\text{ V}; I_B = 0$	–	–	1	μA
I_{EBO}	emitter-base cut-off current	$V_{EB} = 5\text{ V}; I_C = 0$	–	–	400	μA
h_{FE}	DC current gain	$V_{CE} = 5\text{ V}; I_C = 5\text{ mA}$	30	–	–	
V_{CEsat}	collector-emitter saturation voltage	$I_C = 10\text{ mA}; I_B = 0.5\text{ mA}$	–	–	300	mV
$V_{i(off)}$	input-off voltage	$V_{CE} = 5\text{ V}; I_C = 100\text{ }\mu\text{A}$	–	–	0.5	V
$V_{i(on)}$	input-on voltage	$V_{CE} = 0.3\text{ V}; I_C = 10\text{ mA}$	3	–	–	V
R1	input resistor		7	10	13	k Ω
$\frac{R2}{R1}$	resistor ratio		0.8	1	1.2	
C_c	collector capacitance	$V_{CB} = 10\text{ V}; I_E = i_e = 0; f = 1\text{ MHz}$	–	–	2.5	pF

Note

1. Pulse test: $t_p \leq 300\text{ }\mu\text{s}; \delta \leq 0.02$.

12 V PNP loadswitch

PEMF21

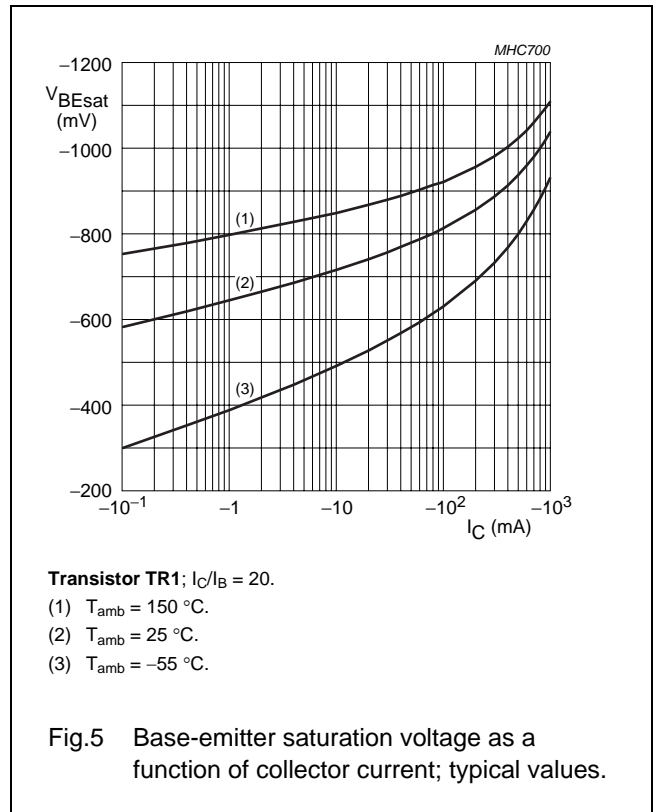
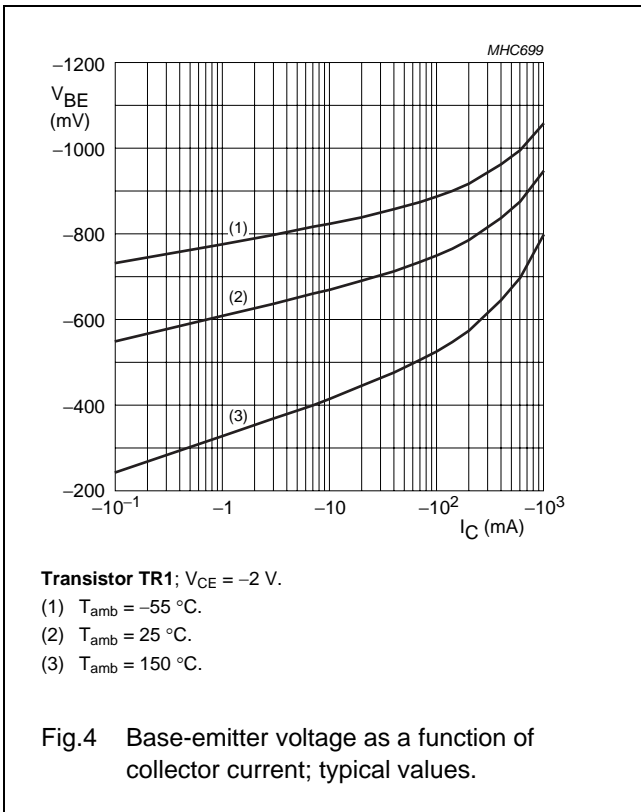
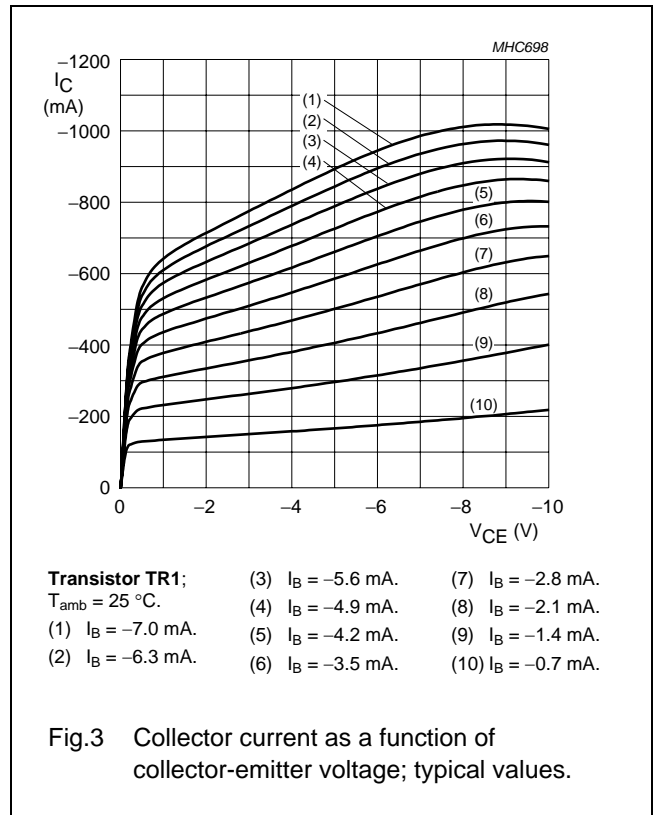
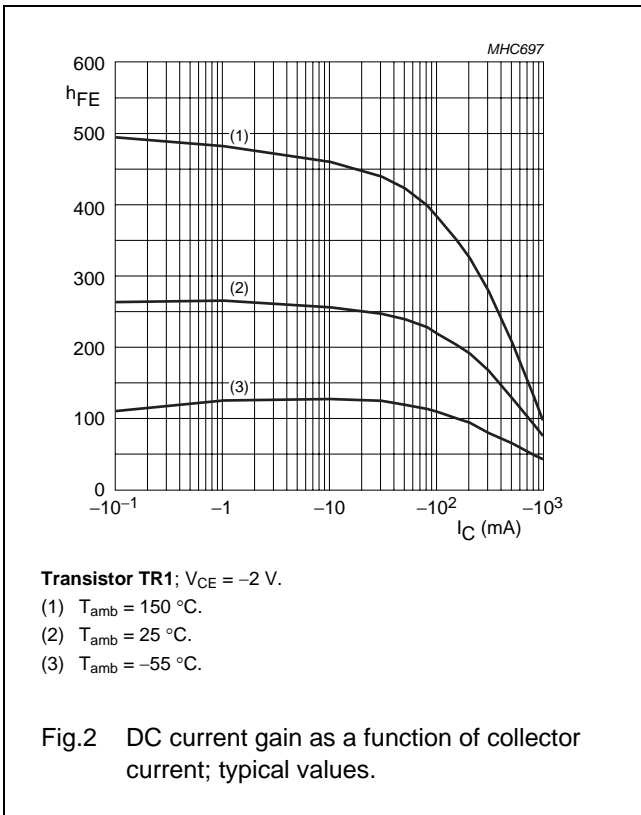

12 V PNP loadswitch

PEMF21

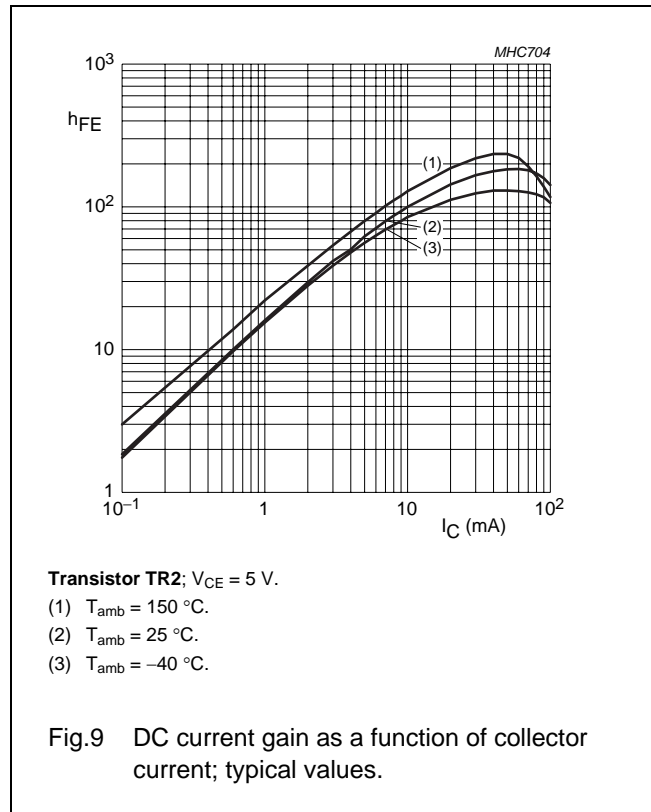
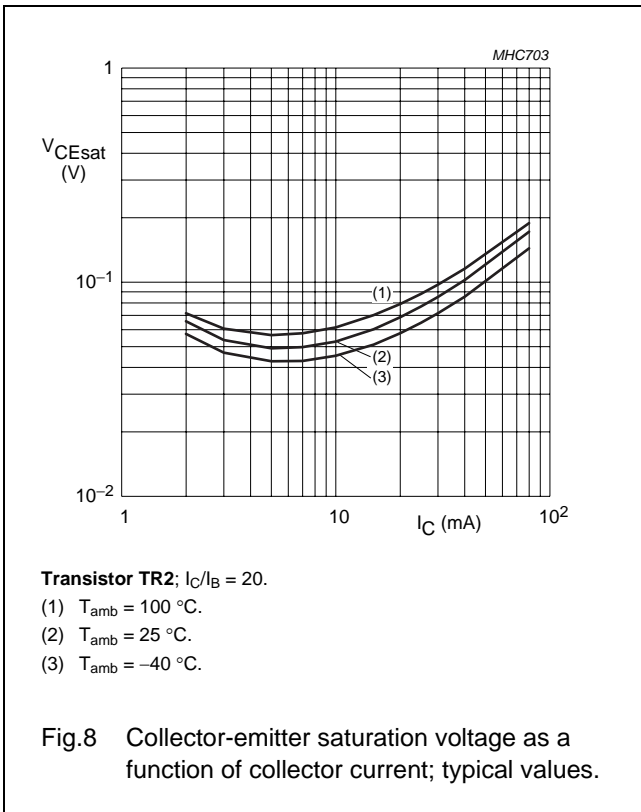
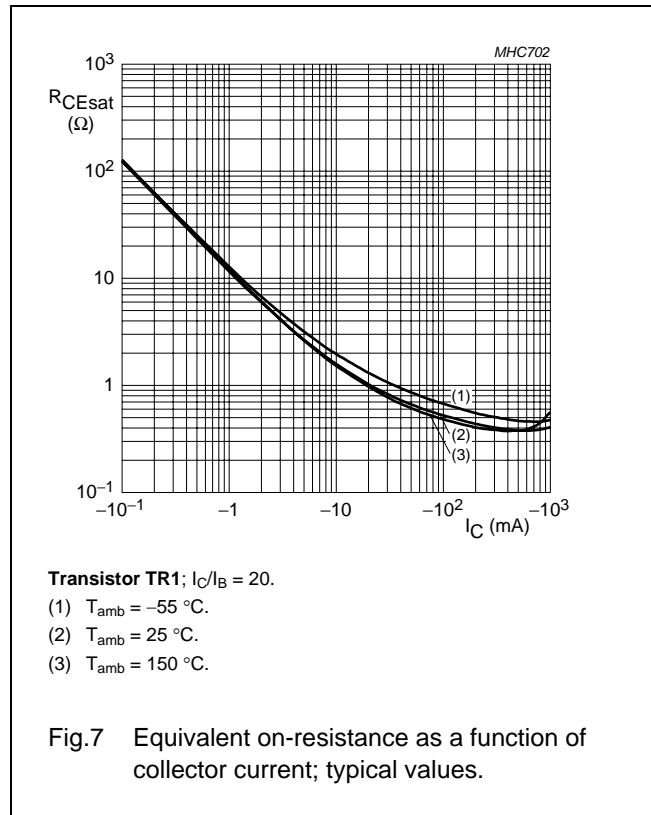
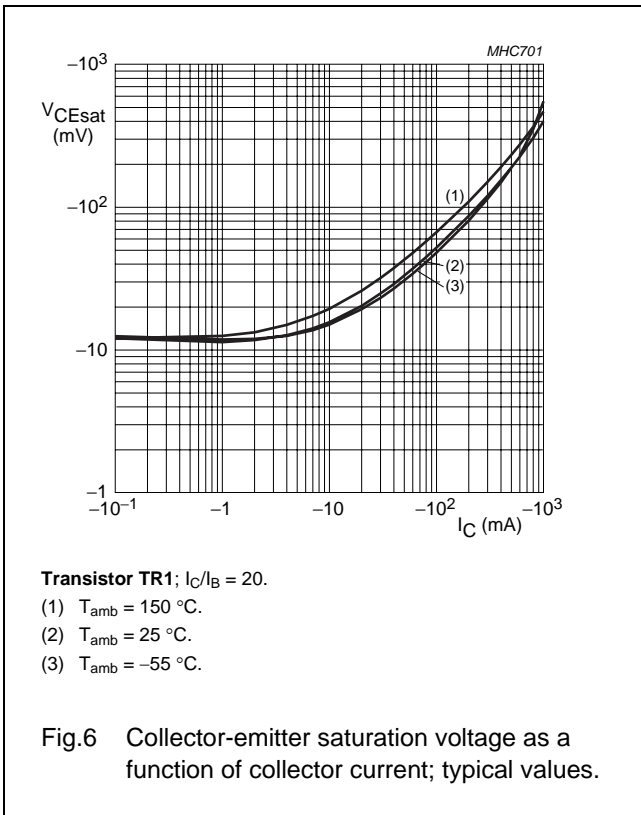

12 V PNP loadswitch

PEMF21

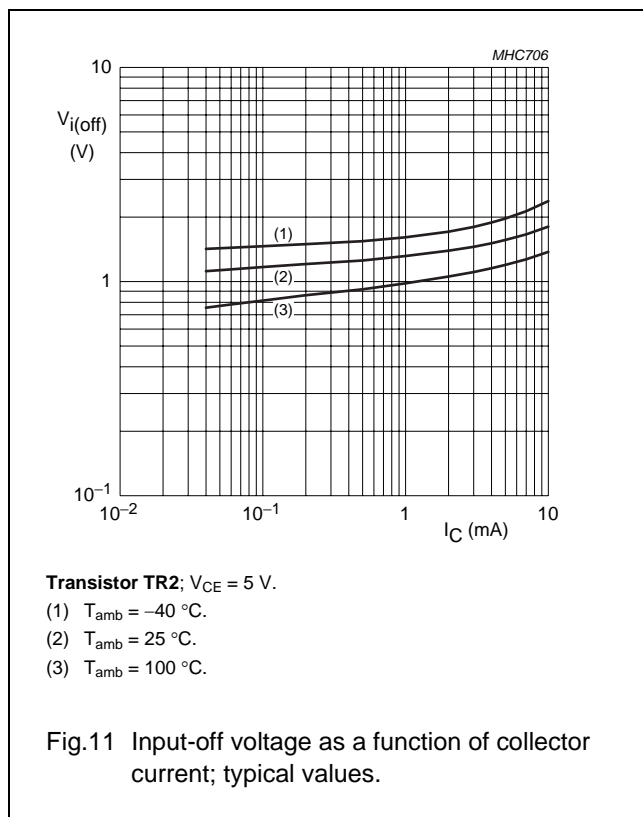
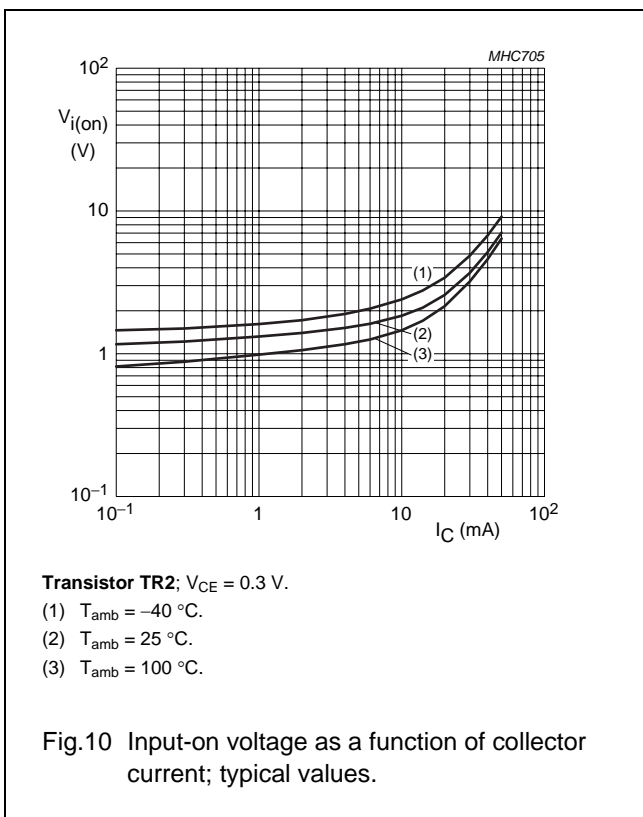

12 V PNP loadswitch

PEMF21

PACKAGE OUTLINE

Plastic surface-mounted package; 6 leads

SOT666

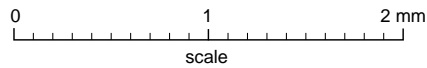
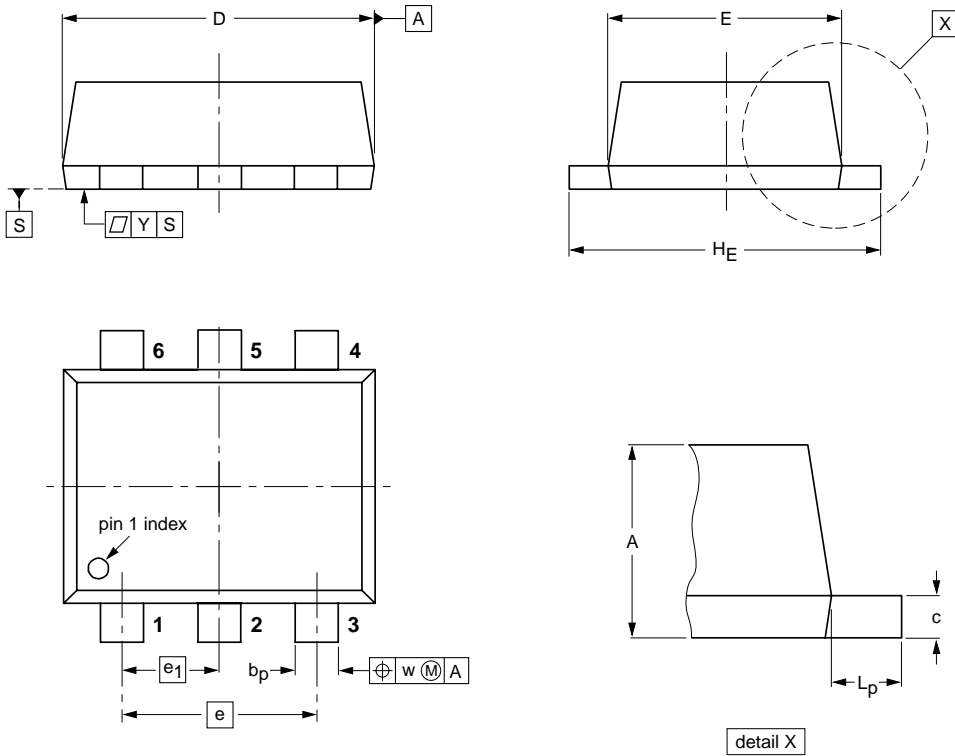

DIMENSIONS (mm are the original dimensions)

UNIT	A	b_p	c	D	E	e	e_1	H_E	L_p	w	y
mm	0.6 0.5	0.27 0.17	0.18 0.08	1.7 1.5	1.3 1.1	1.0	0.5	1.7 1.5	0.3 0.1	0.1	0.1

OUTLINE VERSION	REFERENCES				EUROPEAN PROJECTION	ISSUE DATE
	IEC	JEDEC	JEITA			
SOT666						04-11-08 06-03-16

12 V PNP loadswitch

PEMF21

DATA SHEET STATUS

DOCUMENT STATUS ⁽¹⁾	PRODUCT STATUS ⁽²⁾	DEFINITION
Objective data sheet	Development	This document contains data from the objective specification for product development.
Preliminary data sheet	Qualification	This document contains data from the preliminary specification.
Product data sheet	Production	This document contains the product specification.

Notes

1. Please consult the most recently issued document before initiating or completing a design.
2. The product status of device(s) described in this document may have changed since this document was published and may differ in case of multiple devices. The latest product status information is available on the Internet at URL <http://www.nxp.com>.

DISCLAIMERS

General — Information in this document is believed to be accurate and reliable. However, NXP Semiconductors does not give any representations or warranties, expressed or implied, as to the accuracy or completeness of such information and shall have no liability for the consequences of use of such information.

Right to make changes — NXP Semiconductors reserves the right to make changes to information published in this document, including without limitation specifications and product descriptions, at any time and without notice. This document supersedes and replaces all information supplied prior to the publication hereof.

Suitability for use — NXP Semiconductors products are not designed, authorized or warranted to be suitable for use in medical, military, aircraft, space or life support equipment, nor in applications where failure or malfunction of an NXP Semiconductors product can reasonably be expected to result in personal injury, death or severe property or environmental damage. NXP Semiconductors accepts no liability for inclusion and/or use of NXP Semiconductors products in such equipment or applications and therefore such inclusion and/or use is at the customer's own risk.

Applications — Applications that are described herein for any of these products are for illustrative purposes only. NXP Semiconductors makes no representation or warranty that such applications will be suitable for the specified use without further testing or modification.

Limiting values — Stress above one or more limiting values (as defined in the Absolute Maximum Ratings System of IEC 60134) may cause permanent damage to the device. Limiting values are stress ratings only and operation of the device at these or any other conditions

above those given in the Characteristics sections of this document is not implied. Exposure to limiting values for extended periods may affect device reliability.

Terms and conditions of sale — NXP Semiconductors products are sold subject to the general terms and conditions of commercial sale, as published at <http://www.nxp.com/profile/terms>, including those pertaining to warranty, intellectual property rights infringement and limitation of liability, unless explicitly otherwise agreed to in writing by NXP Semiconductors. In case of any inconsistency or conflict between information in this document and such terms and conditions, the latter will prevail.

No offer to sell or license — Nothing in this document may be interpreted or construed as an offer to sell products that is open for acceptance or the grant, conveyance or implication of any license under any copyrights, patents or other industrial or intellectual property rights.

Export control — This document as well as the item(s) described herein may be subject to export control regulations. Export might require a prior authorization from national authorities.

Quick reference data — The Quick reference data is an extract of the product data given in the Limiting values and Characteristics sections of this document, and as such is not complete, exhaustive or legally binding.

NXP Semiconductors

Customer notification

This data sheet was changed to reflect the new company name NXP Semiconductors, including new legal definitions and disclaimers. No changes were made to the technical content, except for package outline drawings which were updated to the latest version.

Contact information

For additional information please visit: <http://www.nxp.com>

For sales offices addresses send e-mail to: salesaddresses@nxp.com

© NXP B.V. 2009

All rights are reserved. Reproduction in whole or in part is prohibited without the prior written consent of the copyright owner.

The information presented in this document does not form part of any quotation or contract, is believed to be accurate and reliable and may be changed without notice. No liability will be accepted by the publisher for any consequence of its use. Publication thereof does not convey nor imply any license under patent- or other industrial or intellectual property rights.

Printed in The Netherlands

R75/01/pp10

Date of release: 2004 Jan 12

Document order number: 9397 750 12204

