

## Multi SMD LED RGB



20777

### DESCRIPTION

VLMRGB343.. tricolor LEDs is a high brightness device designed for demanding applications in efficiency and reduced space. An ideal device in emphasizing visual effects, advertisement, decoration as well as general backlighting needs.

### PRODUCT GROUP AND PACKAGE DATA

- Product group: LED
- Package: SMD PLCC-4
- Product series: RGB
- Angle of half intensity:  $\pm 60^\circ$

### FEATURES

- High brightness tricolor SMD LED
- RGB individual control
- Compact package outline
- Black surface
- Qualified according to JEDEC® moisture sensitivity level 2
- Compatible to IR reflow soldering
- AEC-Q101 qualified
- ESD-withstand voltage: up to 1 kV according to JESD22-A114-B
- Material categorization: for definitions of compliance please see [www.vishay.com/doc?99912](http://www.vishay.com/doc?99912)

AUTOMOTIVE GRADE

**RoHS**  
 COMPLIANT  
 HALOGEN  
**FREE**  
**GREEN**  
 (5-2008)

### APPLICATIONS

- Wide range of accent and decorative lighting
- Displays: full color message and displays video boards
- Consumer appliances: backlight LCDs, PDAs, TVs
- Industry: white goods such as ovens, microwaves, etc.

### PARTS TABLE

PART	COLOR	LUMINOUS INTENSITY (mcd)			at I <sub>F</sub> (mA)	WAVELENGTH (nm)			at I <sub>F</sub> (mA)	FORWARD VOLTAGE (V)			at I <sub>F</sub> (mA)	TECHNOLOGY
		MIN.	TYP.	MAX.		MIN.	TYP.	MAX.		MIN.	TYP.	MAX.		
VLMRGB343-ST-UV-RS	Red	140	-	285	20	618	625	628	20	-	1.8	2.45	20	AllnGaP
	True green	285	-	560	20	521	526	536	20	-	3.7	4.25	20	InGaN
	Blue	100	-	200	20	465	470	475	20	-	3.6	4.25	20	InGaN

#### Note

- Reel comes in a quantity of 2050 units per reel. Luminous intensity is measured with an accuracy of  $\pm 11\%$ . All electrical and optical data are measured at room temperature of 25 °C.

### ABSOLUTE MAXIMUM RATINGS (T<sub>amb</sub> = 25 °C, unless otherwise specified) VLMRGB343.., RED

PARAMETER	TEST CONDITION	SYMBOL	VALUE	UNIT
Forward current		I <sub>F</sub>	30	mA
Reverse voltage		V <sub>R</sub>	12	V
Power dissipation		P <sub>tot</sub>	75	mW
Junction temperature		T <sub>j</sub>	125	°C
Surge current t <sub>p</sub> < 10 μs, duty cycle = 0.005		I <sub>FM</sub>	1000	mA
Thermal resistance junction/solder point 1 chip on 3 chip on		R <sub>thJP</sub>	260 420	K/W
Thermal resistance junction/ambient 1 chip on 3 chip on		R <sub>thJA</sub>	480 770	K/W
Operating temperature		T <sub>amb</sub>	-40 to +100	°C
Storage temperature		T <sub>stg</sub>	-40 to +100	°C
Forward voltage	20 mA	V <sub>F</sub>	1.8 to 2.45	V



<b>ABSOLUTE MAXIMUM RATINGS</b> ( $T_{amb} = 25\text{ }^{\circ}\text{C}$ , unless otherwise specified) <b>VLMRGB343.., TRUE GREEN, BLUE</b>				
PARAMETER	TEST CONDITION	SYMBOL	VALUE	UNIT
Forward current		$I_F$	20	mA
Reverse voltage		$V_R$	5	V
Power dissipation		$P_{tot}$	85	mW
Junction temperature		$T_j$	125	$^{\circ}\text{C}$
Surge current; $t_p < 10\text{ }\mu\text{s}$ , duty cycle = 0.005		$I_{FM}$	200	mA
Thermal resistance junction/solder point 1 chip on 3 chip on		$R_{thJP}$	290 470	K/W
Thermal resistance junction/ambient 1 chip on 3 chip on		$R_{thJA}$	530 820	K/W
Operating temperature		$T_{amb}$	-40 to +100	$^{\circ}\text{C}$
Storage temperature		$T_{stg}$	-40 to +100	$^{\circ}\text{C}$
Forward voltage	20 mA	$V_F$	3.7 to 4.25	V

<b>OPTICAL AND ELECTRICAL CHARACTERISTICS</b> ( $T_{amb} = 25\text{ }^{\circ}\text{C}$ , unless otherwise specified) <b>VLMRGB343.., RED, TRUE GREEN, BLUE</b>													
PARAMETER	TEST CONDITION	PART	FLOATING GROUPS	COLOR	SYMBOL	MIN.	TYP.	MAX.	UNIT				
Luminous intensity	$I_F = 20\text{ mA}$	VLMRGB343-ST-UV-RS		red	$I_V$	140		285	mcd				
				true green		285		560					
				blue		100		200					
		VLMRGB343..		S3U3R3		red	$I_V$	140		200	mcd		
						true green		285		400			
						blue		100		140			
				S3U3S3				red	$I_V$	140		200	mcd
								true green		285		400	
								blue		140		200	
				S3V3R3				red	$I_V$	140		200	mcd
								true green		400		560	
								blue		100		140	
				S3V3S3				red	$I_V$	140		200	mcd
								true green		400		560	
								blue		140		200	
		T3U3R3				red	$I_V$	200		285	mcd		
						true green		285		400			
						blue		100		140			
		T3U3S3				red	$I_V$	200		285	mcd		
						true green		285		400			
						blue		140		200			
		T3V3R3				red	$I_V$	200		285	mcd		
						true green		400		560			
						blue		100		140			
		T3V3S3				red	$I_V$	200		285	mcd		
						true green		400		560			
						blue		140		200			
Dominant wavelength		VLMRGB343..		red	$\lambda_d$	618	625	628	nm				
	true green			521		526	536						
	blue			465		470	475						
Angle of half intensity		VLMRGB343..		red	$\phi$		$\pm 60$		deg				
	true green												
	blue												
Forward voltage		VLMRGB343..		red	$V_F$		1.8	2.45	V				
				true green			3.7	4.25					
				blue			3.6	4.25					

**Note**  
 • Not designed for reverse direction



LUMINOUS INTENSITY CLASSIFICATION RED, TRUE GREEN, BLUE		
GROUP	LUMINOUS INTENSITY $I_V$ (mcd)	
STANDARD	MIN.	MAX.
R3	100	140
S3	140	200
T3	200	285
U3	285	400
V3	400	560

**Note**

- The standard shipping format for serial types includes a family group of 5, 6 or 9 individual brightness groups. Individual brightness groups cannot be ordered.

COLOR CLASSIFICATION						
GROUP	DOM. WAVELENGTH (nm)					
	RED <sup>(1)</sup>		TRUE GREEN		BLUE	
	MIN.	MAX.	MIN.	MAX.	MIN.	MAX.
	618	628	521	536	465	475
A			521	526	465	470
B			526	531	470	475
C			531	536		

**Notes**

- Wavelengths are tested at a current pulse duration of 25 ms and an accuracy of  $\pm 1$  nm. Only one wavelength group is allowed for each chip within one reel.
- <sup>(1)</sup> No color grouping for red. Only for check of color.

**TYPICAL CHARACTERISTICS** ( $T_{amb} = 25^\circ\text{C}$ , unless otherwise specified)

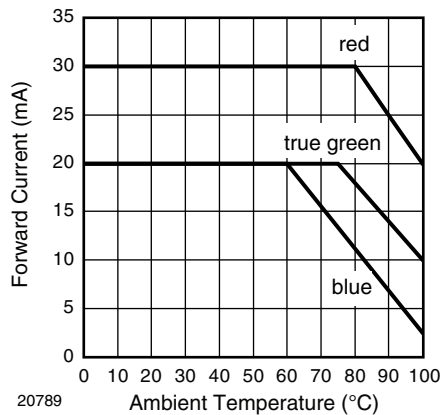

Fig. 1 - Forward Current vs. Ambient Temperature (1 Chip On)

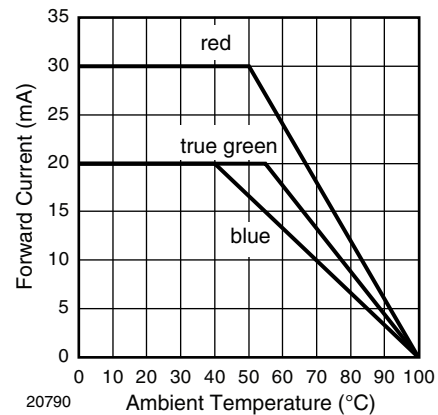

Fig. 2 - Forward Current vs. Ambient Temperature (3 Chips On)

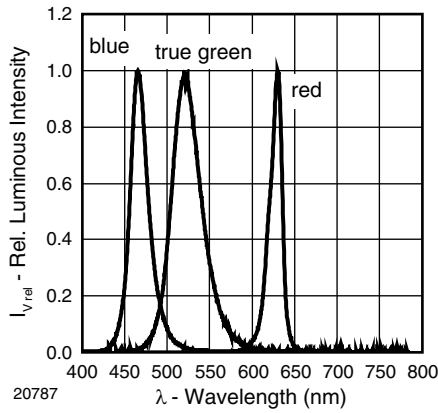

Fig. 3 - Relative Intensity vs. Wavelength

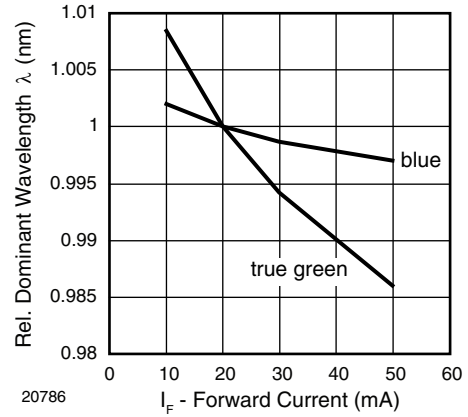

Fig. 6 - Relative Dominant Wavelength vs. Forward Current

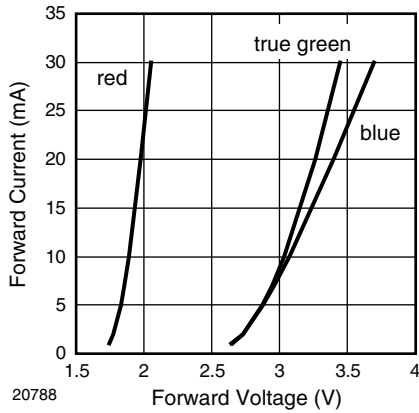

Fig. 4 - Forward Current vs. Forward Voltage

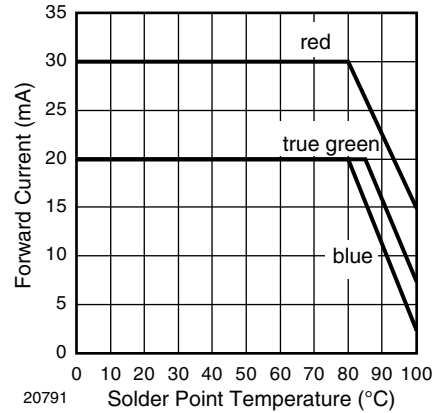

Fig. 7 - Forward Current vs. Solder Point Temperature (1 Chip On)

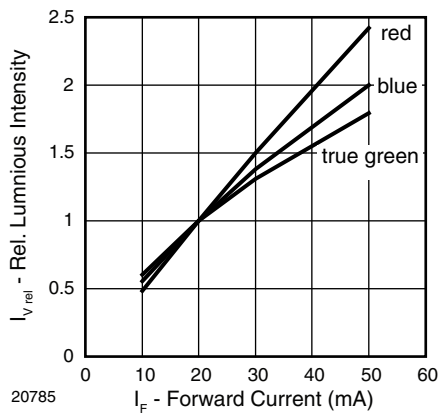

Fig. 5 - Relative Luminous Intensity vs. Forward Current

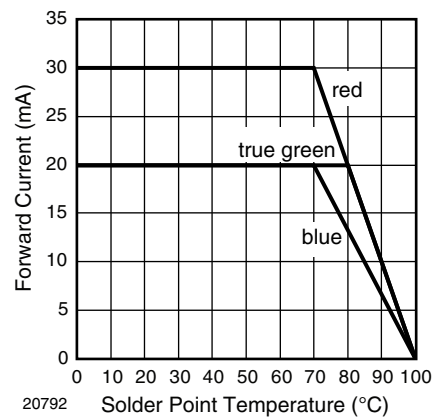
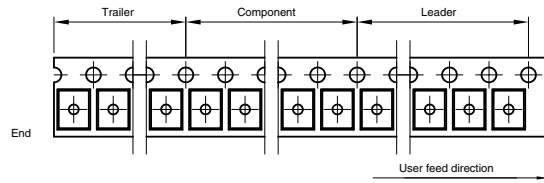
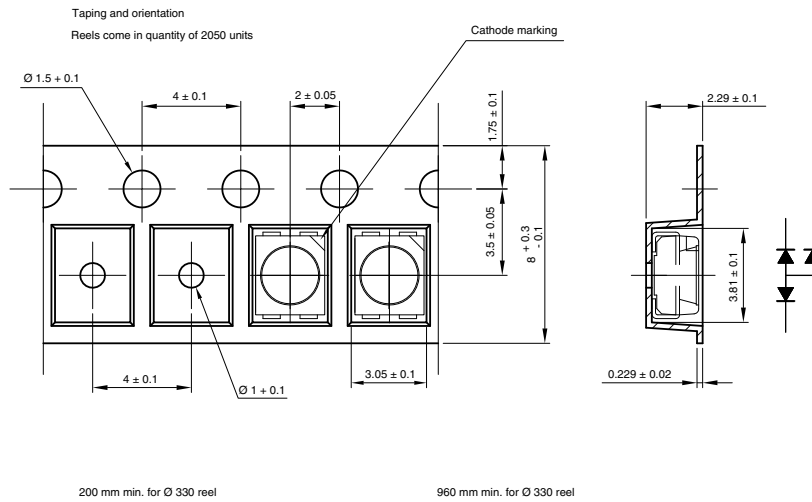

Fig. 8 - Forward Current vs. Solder Point Temperature (3 Chips On)



TAPING DIMENSIONS in millimeters



Drawing-No.: 9.700-5323.01-4  
Issue: 3; 19.02.10  
20819

PACKAGE DIMENSIONS / SOLDERING PADS DIMENSIONS in millimeters

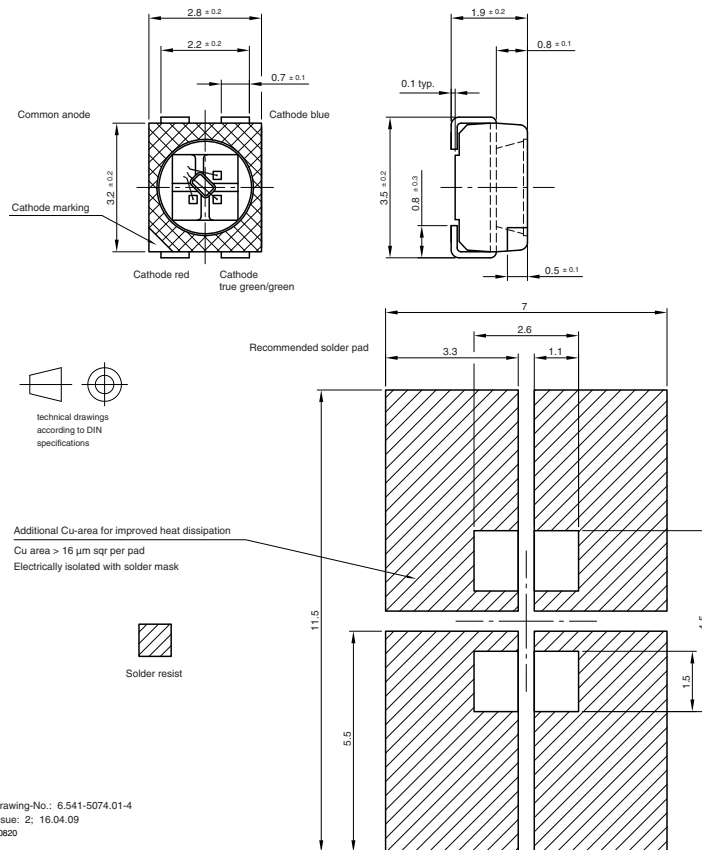

**SOLDERING PROFILE**

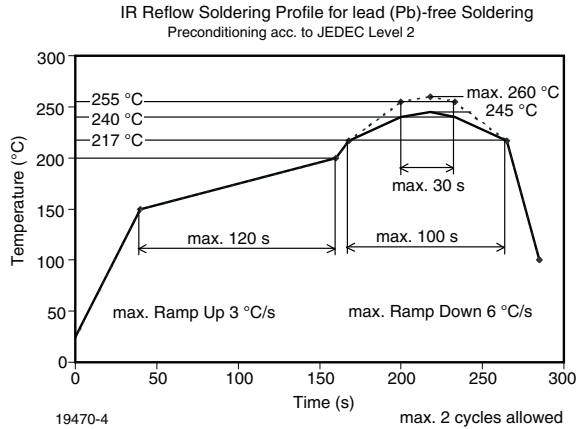
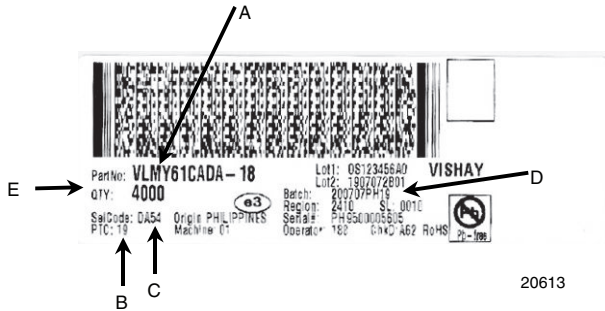

Fig. 9 - Vishay Lead (Pb)-free Reflow Soldering Profile (acc. to J-STD-020)

**BAR CODE PRODUCT LABEL (Example)**



- A) Type of component
- B) Manufacturing plant
- C) SEL - selection code (bin):  
e.g.: DA = code for luminous intensity group  
5 = code for color group  
4 = code for forward voltage
- D) Batch:  
200707 = year 2007, week 07  
PH19 = plant code
- E) Total quantity

**DRY PACKING**

The reel is packed in an anti-humidity bag to protect the devices from absorbing moisture during transportation and storage.

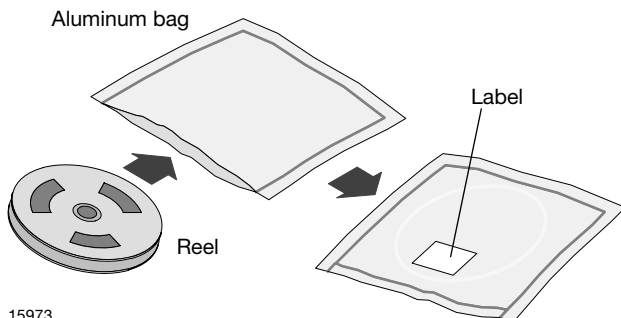

15973

**FINAL PACKING**

The sealed reel is packed into a cardboard box. A secondary cardboard box is used for shipping purposes.

**RECOMMENDED METHOD OF STORAGE**

Dry box storage is recommended as soon as the aluminum bag has been opened to prevent moisture absorption. The following conditions should be observed, if dry boxes are not available:

- Storage temperature 10 °C to 30 °C
- Storage humidity ≤ 60 % RH max.

After more than 1 year under these conditions moisture content will be too high for reflow soldering.

In case of moisture absorption, the devices will recover to the former condition by drying under the following condition:

- 192 h at 40 °C + 5 °C / - 0 °C and < 5 % RH (dry air/nitrogen) or
- 96 h at 60 °C + 5 °C and < 5 % RH for all device containers or
- 24 h at 100 °C + 5 °C not suitable for reel or tubes.

An EIA JEDEC standard JESD22-A112 level 2 label is included on all aluminum dry bags.

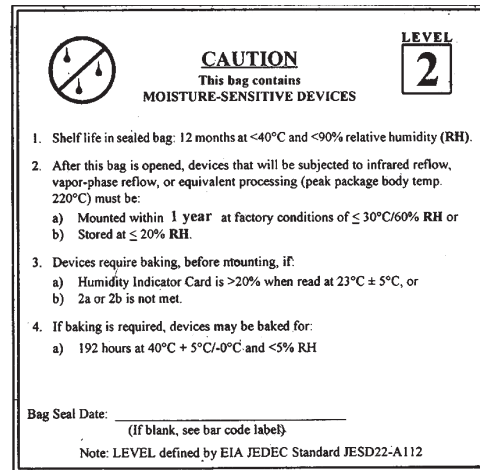

17028

Example of JESD22-A112 level 2 label

**ESD PRECAUTION**

Proper storage and handling procedures should be followed to prevent ESD damage to the devices especially when they are removed from the antistatic shielding bag. Electrostatic sensitive devices warning labels are on the packaging.

**VISHAY SEMICONDUCTORS STANDARD BAR CODE LABELS**

The Vishay Semiconductors standard bar code labels are printed at final packing areas. The labels are on each packing unit and contain Vishay Semiconductors specific data.



## Disclaimer

ALL PRODUCT, PRODUCT SPECIFICATIONS AND DATA ARE SUBJECT TO CHANGE WITHOUT NOTICE TO IMPROVE RELIABILITY, FUNCTION OR DESIGN OR OTHERWISE.

Vishay Intertechnology, Inc., its affiliates, agents, and employees, and all persons acting on its or their behalf (collectively, "Vishay"), disclaim any and all liability for any errors, inaccuracies or incompleteness contained in any datasheet or in any other disclosure relating to any product.

Vishay makes no warranty, representation or guarantee regarding the suitability of the products for any particular purpose or the continuing production of any product. To the maximum extent permitted by applicable law, Vishay disclaims (i) any and all liability arising out of the application or use of any product, (ii) any and all liability, including without limitation special, consequential or incidental damages, and (iii) any and all implied warranties, including warranties of fitness for particular purpose, non-infringement and merchantability.

Statements regarding the suitability of products for certain types of applications are based on Vishay's knowledge of typical requirements that are often placed on Vishay products in generic applications. Such statements are not binding statements about the suitability of products for a particular application. It is the customer's responsibility to validate that a particular product with the properties described in the product specification is suitable for use in a particular application. Parameters provided in datasheets and / or specifications may vary in different applications and performance may vary over time. All operating parameters, including typical parameters, must be validated for each customer application by the customer's technical experts. Product specifications do not expand or otherwise modify Vishay's terms and conditions of purchase, including but not limited to the warranty expressed therein.

Except as expressly indicated in writing, Vishay products are not designed for use in medical, life-saving, or life-sustaining applications or for any other application in which the failure of the Vishay product could result in personal injury or death. Customers using or selling Vishay products not expressly indicated for use in such applications do so at their own risk. Please contact authorized Vishay personnel to obtain written terms and conditions regarding products designed for such applications.

No license, express or implied, by estoppel or otherwise, to any intellectual property rights is granted by this document or by any conduct of Vishay. Product names and markings noted herein may be trademarks of their respective owners.