

MICROCOMPUTER

AM13L-STK2 Installation Manual

Pub.No. 1174602-012E

- When you install each device after unpacking, please read this manual as a first step.
- This manual describes about unpacking, setting of each device, assembly, connection and startup. Please refer to other manual for the particular methods.

Request for your special attention and precautions in using the technical information and semiconductors described in this book

- (1) If any of the products or technical information described in this book is to be exported or provided to non-residents, the laws and regulations of the exporting country, especially, those with regard to security export control, must be observed.
- (2) The technical information described in this book is intended only to show the main characteristics and application circuit examples of the products. No license is granted in and to any intellectual property right or other right owned by Panasonic Corporation or any other company. Therefore, no responsibility is assumed by our company as to the infringement upon any such right owned by any other company which may arise as a result of the use of technical information described in this book.
- (3) The products described in this book are intended to be used for general applications (such as office equipment, communications equipment, measuring instruments and household appliances), or for specific applications as expressly stated in this book. Consult our sales staff in advance for information on the following applications:
 - Special applications (such as for airplanes, aerospace, automotive equipment, traffic signaling equipment, combustion equipment, life support systems and safety devices) in which exceptional quality and reliability are required, or if the failure or malfunction of the products may directly jeopardize life or harm the human body.It is to be understood that our company shall not be held responsible for any damage incurred as a result of or in connection with your using the products described in this book for any special application, unless our company agrees to your using the products in this book for any special application.
- (4) The products and product specifications described in this book are subject to change without notice for modification and/or improvement. At the final stage of your design, purchasing, or use of the products, therefore, ask for the most up-to-date Product Standards in advance to make sure that the latest specifications satisfy your requirements.
- (5) When designing your equipment, comply with the range of absolute maximum rating and the guaranteed operating conditions (operating power supply voltage and operating environment etc.). Especially, please be careful not to exceed the range of absolute maximum rating on the transient state, such as power-on, power-off and mode-switching. Otherwise, we will not be liable for any defect which may arise later in your equipment.
Even when the products are used within the guaranteed values, take into the consideration of incidence of break down and failure mode, possible to occur to semiconductor products. Measures on the systems such as redundant design, arresting the spread of fire or preventing glitch are recommended in order to prevent physical injury, fire, social damages, for example, by using the products.
- (6) Comply with the instructions for use in order to prevent breakdown and characteristics change due to external factors (ESD, EOS, thermal stress and mechanical stress) at the time of handling, mounting or at customer's process. When using products for which damp-proof packing is required, satisfy the conditions, such as shelf life and the elapsed time since first opening the packages.
- (7) This book may be not reprinted or reproduced whether wholly or partially, without the prior written permission of our company.

20100202

If you have any inquiries or questions about this book or our semiconductor products, please contact our sales division.

PanaXSeries is a registered trademark of Panasonic Corporation.

Microsoft, Windows and the Windows logo are either registered trademarks or trademarks of Microsoft Corporation in the United States and/or other countries.

DebugFactory is a registered trademark of Panasonic Corporation.

DebugFactory Builder is a trademark of Panasonic Corporation.

The other corporation names, logotype and product names written in this book are trademarks or registered trademarks of their corresponding corporations.

About This Manual

This manual is intended for engineers who will evaluate MN101LR05D using AM13L-STK2, which is a starter kit of microcomputer MN101LR05D with built-in ReRAM, and describes the installation method.

■ Organization

This manual mainly consists of four chapters of overview, software, hardware and appendix.

The overview chapter describes a product outline and hardware functions of AM13L-STK2.

The software chapter describes how to install the USB driver for connecting AM13L-STK2 with a host computer and how to install the debugger for AM13L-STK2(DebugFactory Builder for MN101_STK2).

The hardware chapter describes details of each part and how to connect and how to customize the board.

The appendix chapter shows a circuit diagram, a part list, and a dimensional drawing.

■ Related Manuals

We prepare the following manuals other than this manual about the product concerned.

- "MN101LR05D LSI User's Manual"

Describes characteristics and the control method of MN101LR05D.

Chapter 1 Overview

Chapter 2 Software

Chapter 3 Hardware

Chapter 4 Appendix

1

2

3

4

Table of Contents

Chapter 1 Overview	7
1.1 Product overview	8
1.1.1 Hardware Functions	8
Chapter 2 Software	9
2.1 Installation	10
2.1.1 Checking Operating Environment	10
2.1.2 Download of Software	10
2.1.3 Setup of the DebugFactory Builder for MN101_STK2	11
2.2 Installation of USB Driver	16
2.3 Safely Removing Hardware	18
2.4 Firmware Update Procedure	19
2.5 Checking Operations of DebugFactory Builder for MN101_STK2	21
2.6 Debug Function List	33
2.7 Notices for debugging with DebugFactory Builder for MN101_STK2	34
Chapter 3 Hardware	35
3.1 Part Names and Functions	36
3.2 Debugger Connection	42
3.3 Customization of AM13L-STK2	43
3.3.1 Use of Extension Terminals	43
3.3.2 Current Measurement	44
Chapter 4 Appendix	45
4.1 Circuit Diagram	46
4.2 Part List	47
4.3 Dimensions	48

Chapter 1 Overview

1.1 Product overview

This product is the starter kit for evaluating microcomputer MN101LR05D with built-in ReRAM. You can evaluate microcomputer MN101LR05D with built-in ReRAM easily by connecting it with the USB port of the host computer directly and using the debugger for AM13L-STK2 (DebugFactory Builder for MN101_STK2).

1.1.1 Hardware Functions

This section describes hardware functions of AM13L-STK2.

- Operating Voltage
 - +4.7 V to +5.25 V
Supplied from an USB bus power or an USB type AC adapter.
 - +1.8 V to +3.6 V
Supplied directly from an extension terminal of AM13L-STK2 to a microcomputer (a setting change on the board is needed).

- Mounted Microcomputer
MN101LR05D

- Reset
RC reset (the reset period is 500ms)

- Controllable Functions
 - I/O port: 35 pins (all are dual purpose terminals.)
 - LED (high-power) drive dual purpose terminal: 35 pins (2 pins are assigned to the LEDs on AM13L-STK2.)
 - A/D input dual purpose terminal: 4 pins
 - Timer input/output dual purpose terminal: 3 pins
 - External interrupt dual purpose terminal: 6 pins
 - Serial port dual purpose terminal: 5 pins (UART: 3 pin, I2C: 2 pin, both serves as synchronous serial ports.)
 - LCD control terminal: 30 pins (4COM/26SEG)

- External Supply Voltage
 - The voltage of +3.3 V and +5.0 V can be supplied from extension terminals of AM13L-STK2 to an external extension board.
 - The total supply current is a maximum of 500 mA (current consumption of AM13L-STK2 is included.)

Chapter 2 Software

2.1 Installation

2.1.1 Checking Operating Environment

■ Host Computer Specifications

Table 2.1.1 Host Computer Specifications

OS (Except virtual environment)	Windows XP (after SP2) (32bit OS only)	Windows Vista (32bit OS only) Windows 7 (32bit / 64bit OS)
CPU	Intel Pentium III 450 MHz or higher *including compatible CPU (Pentium III 1 GHz or higher recommended)	Intel Pentium III 1GHz or higher *including compatible CPU
Memory	256 MB minimum (512 MB or more recommended)	1GB or more
Available hard disk space	400 MB minimum (1 GB or more recommended)	
Others	with USB1.1/2.0 interface	

Note :The memory required depends on the size of the program to create.

2.1.2 Download of Software

When developing and debugging software of AM13L-STK2, it is necessary to install the debugger for AM13L-STK2 (DebugFactory Builder for MN101_STK2).

On the support page of Panasonic Microcomputer Technical Support
<<http://www.semicon.panasonic.co.jp/e-micom/support.html>>, select "Starter kit", open the starter kit introduction page, and download the following programs.

- DebugFactory Builder for MN101_STK2 (DFBuilder101_STK2_v4.6.4.1.EXE)

Note :DebugFactory Builder for MN101_STK2 incorporates the product version compiler, assembler and linker. Therefore it is not necessary to install the compiler separately.

2.1.3 Setup of the DebugFactory Builder for MN101_STK2

This section describes procedures of install the debugger for AM13L-STK2 (DebugFactory Builder for MN101_STK2).

Note : - The installation must be done by members of the Administrators group. Users (including Power Users) who do not belong to the Administrators group cannot do this work.
- Do not connect AM13L-STK2 to the host computer when installing DebugFactory Builder for MN101_STK2.

1. Double-click the icon of DebugFactory Builder for MN101_STK2 (DFBuilder101_STK2_v4.6.4.1.EXE) which has been downloaded, and start the DebugFactory Builder for MN101_STK2. (Refer to Figure 2.1.1.)

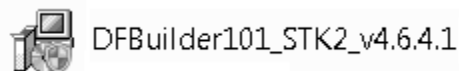

Figure 2.1.1 Icon of DebugFactory Builder for MN101_STK2

2. When an installer program of DebugFactory Builder is executed, a dialog of Figure 2.1.2 appears. Select the language that you use the DebugFactory Builder for MN101_STK2.

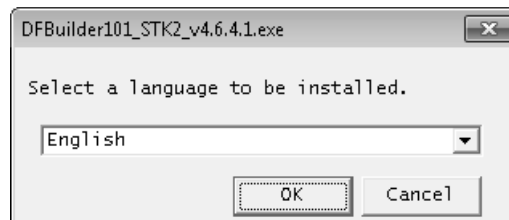

Figure 2.1.2 Selecting the language

3. After Setup program is started, the dialog shown in Figure 2.1.3 appears. Click <Next>.

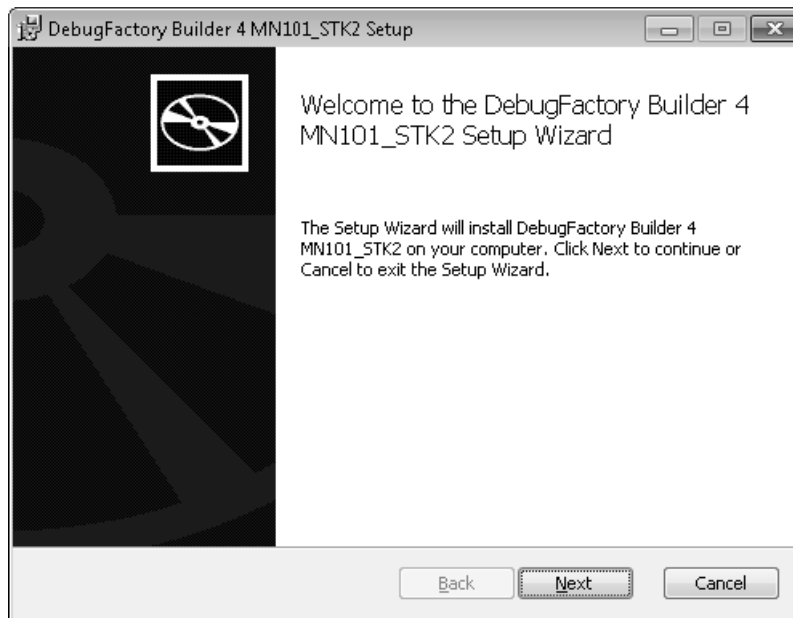

Figure 2.1.3 Starting of setting up DebugFactory Builder for MN101_STK2

4. The dialog shown in Figure 2.1.4 appears. Confirm the software license agreement, and click <Next>.

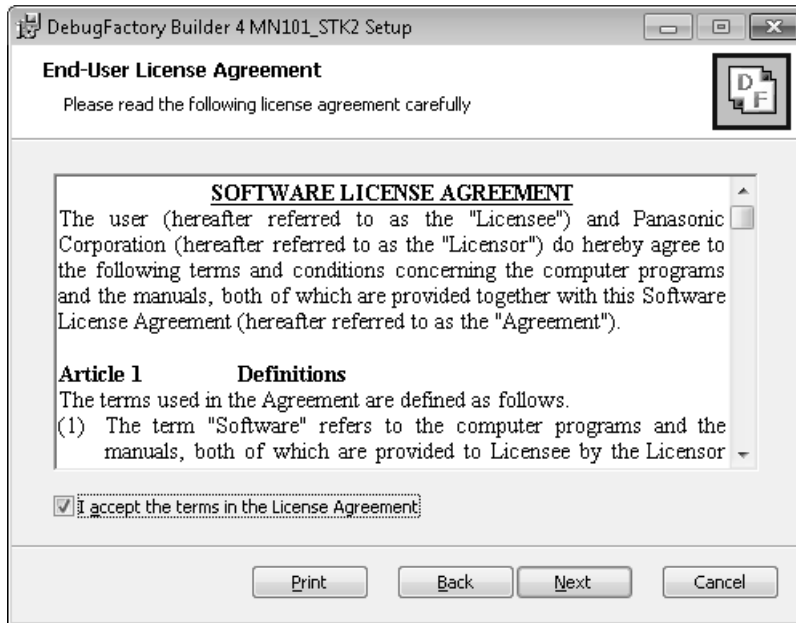

Figure 2.1.4 Licence agreement of AM13L_STK2

5. The dialog shown in Figure 2.1.5 appears. Confirm the destination folder where the software tools will be installed, then click <Next>. If you want to install in a different folder, click <Change...> to specify the folder.

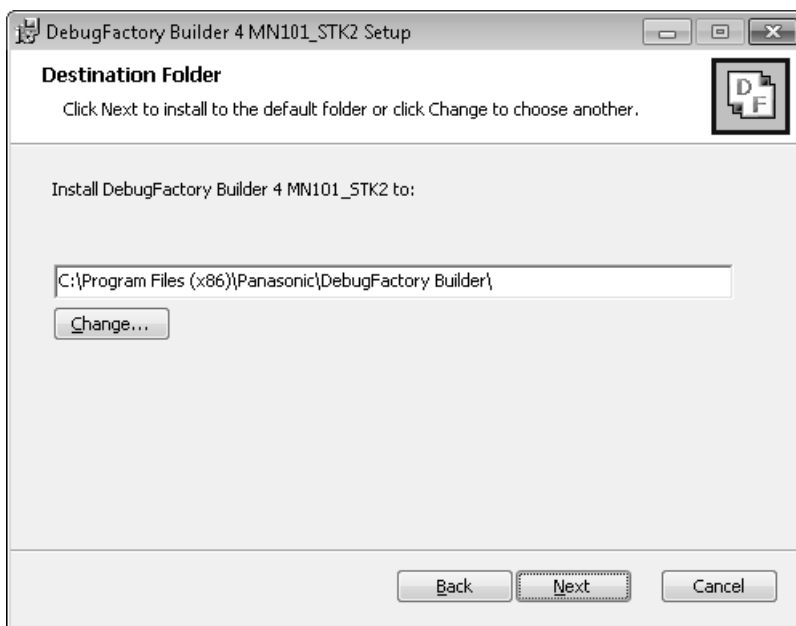

Figure 2.1.5 Choose Destination Folder

6. The dialog shown in Figure 2.1.6 appears. Click <Install>.

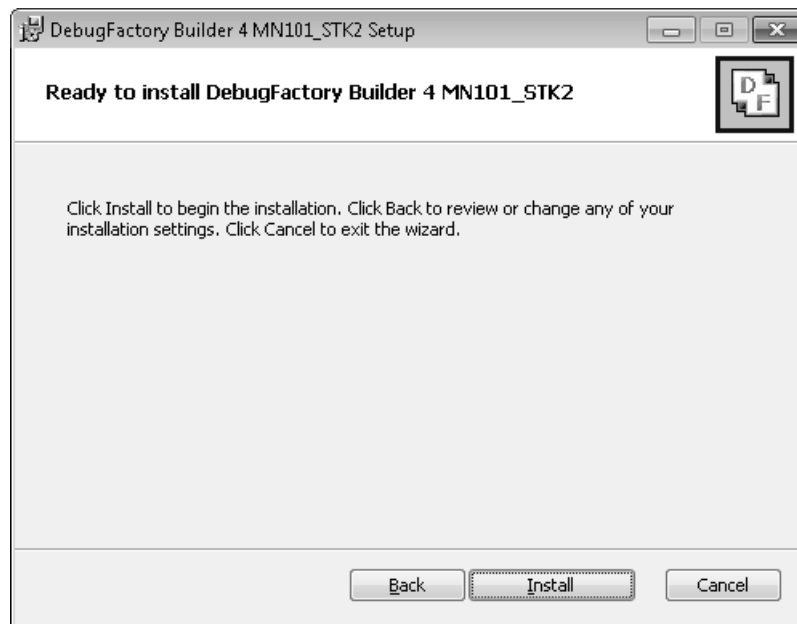

Figure 2.1.6 Start Installation

7. The dialog shown in Figure 2.1.7 appears. Wait while DebugFactory Builder for MN101_STK2 installs.

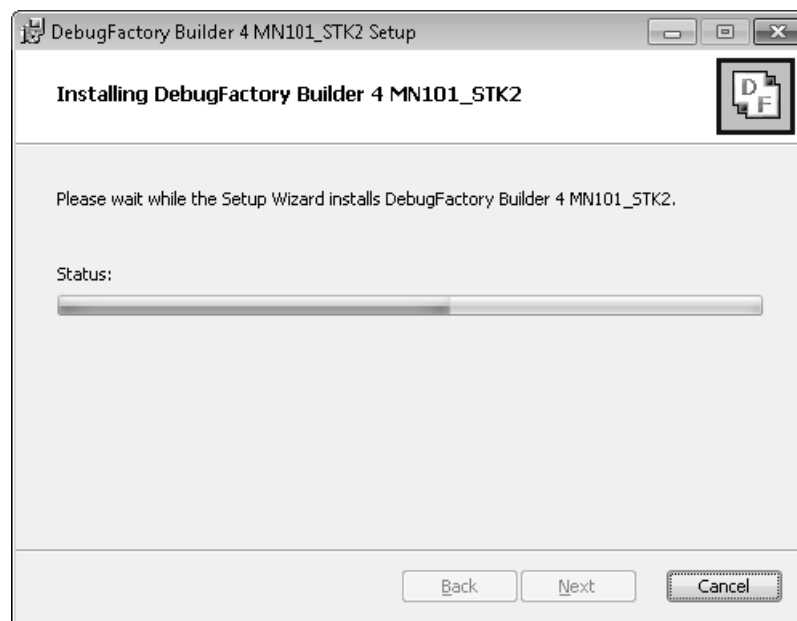

Figure 2.1.7 During installing of DebugFactory Builder for MN101_STK2

8. The dialog shown in Figure 2.1.8 appears. Click <Finish>.

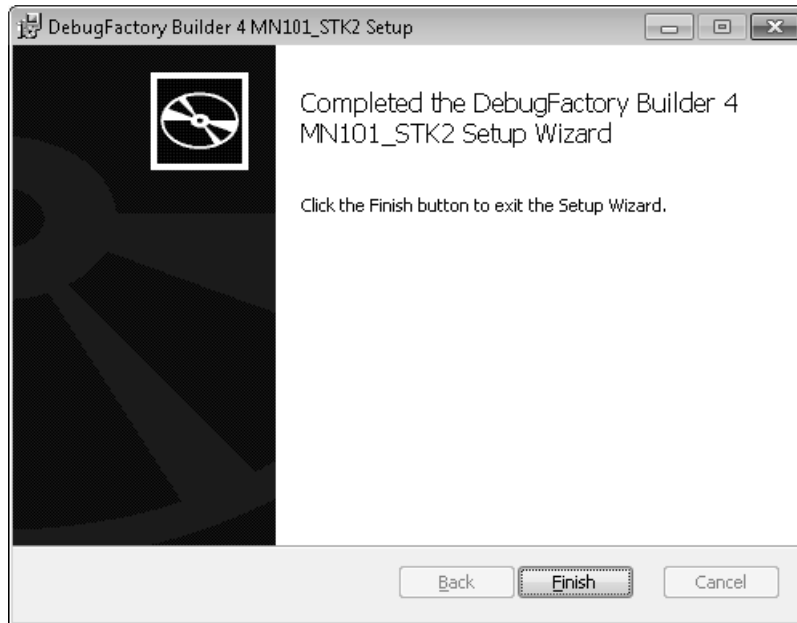

Figure 2.1.8 Setup Completed

9. After the installation is completed, [Panasonic DebugFactory Builder 4]-[MN101_STK2] group is registered in [All Programs] on the menu [Start]. Figure 2.1.9 shows the shortcut just registered.

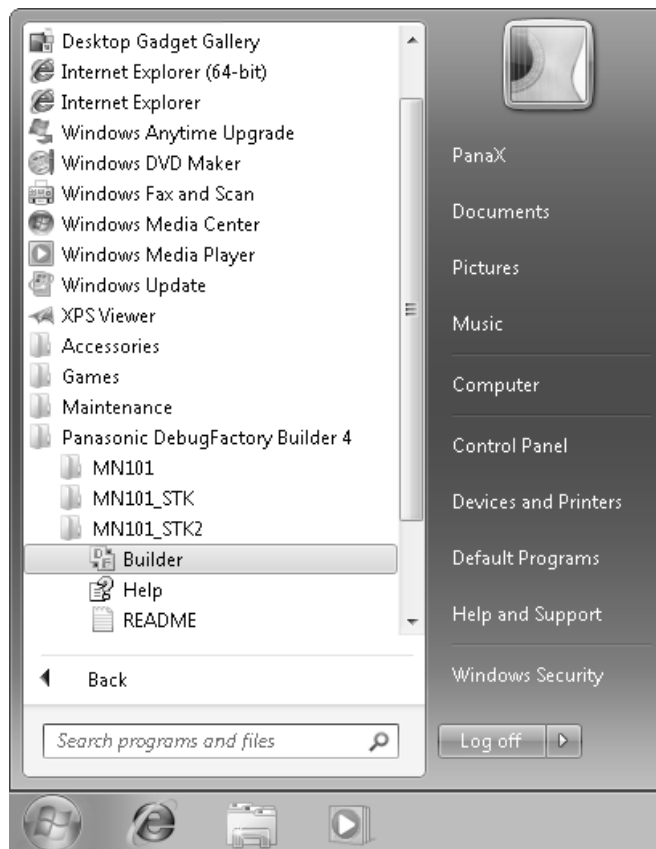

Figure 2.1.9 Registered [Panasonic DebugFactory Builder 4]-[MN101_STK2] Group

Table 2.1.2 Registered [Panasonic DebugFactory Builder 4]-[MN101_STK2] Group

Shortcut name	Description
Builder	Run the DebugFactory Builder for MN101_STK2.
README	Displays additional information and cautions not included in the manual.
Help	Displays Help of the DebugFactory Builder for MN101_STK2.

2.2 Installation of USB Driver

Connect the AM13L-STK2 to the host computer as shown in Figure 2.2.1.

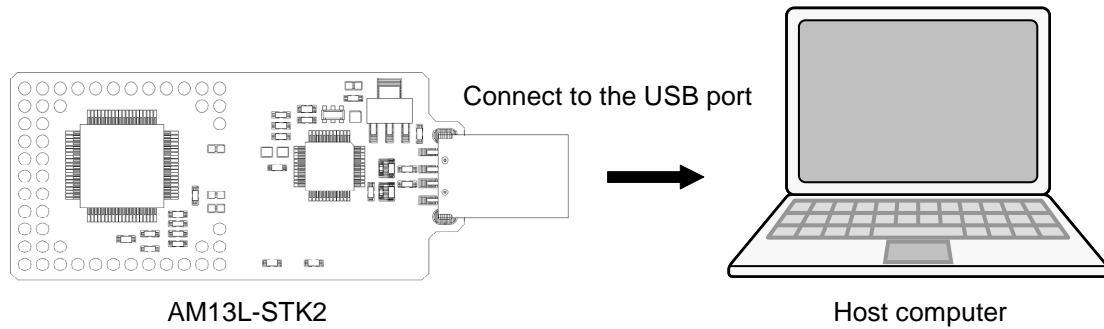

Figure 2.2.1 Connecting AM13L-STK2 and the host computer

If the USB driver is not installed in the host computer, after the AM13L-STK2 is connected, installation of the USB driver starts.

Note : - Install DebugFactory Builder for MN101_STK2 before connecting the AM13L-STK2 to the host computer. For details about installation of DebugFactory Builder for MN101_STK2, refer to "2.1.3 Setup of the DebugFactory Builder for MN101_STK2 (p.11)".
- The installation of USB driver must be done by members of the Administrators group.

1. The balloon hint is displayed at the lower right of the screen as shown in Figure 2.2.2.

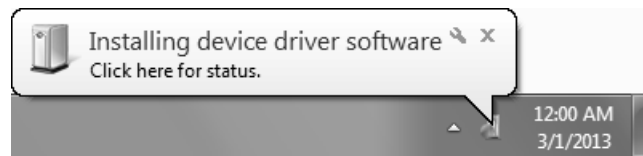

Figure 2.2.2 Installing device driver software

After a while, the balloon hint is shown in Figure 2.2.3.

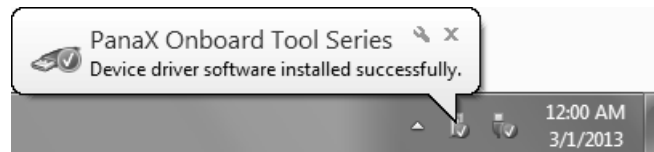

Figure 2.2.3 Complete Installing Device Driver Software

2. When dialog box of Figure 2.2.4 is displayed after driver installation completion, restart of the host computer is necessary.

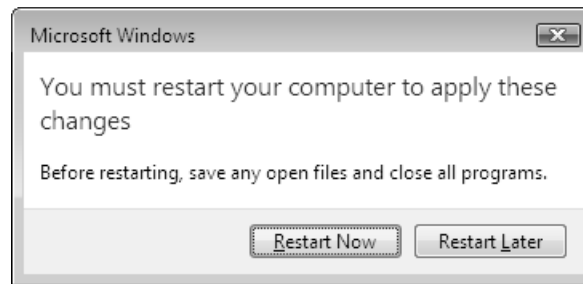

Figure 2.2.4 Restart of the host computer

3. From the [Start] menu, select [Control Panel], and click [System and Security], and click [Device Manager] to display the [Device Manager] window shown in Figure 2.2.5. Verify that "PanaX Onboard Tool Series" is listed in the "PanaXSeries" column. If it is not listed in the column, the USB driver might not have been installed properly.

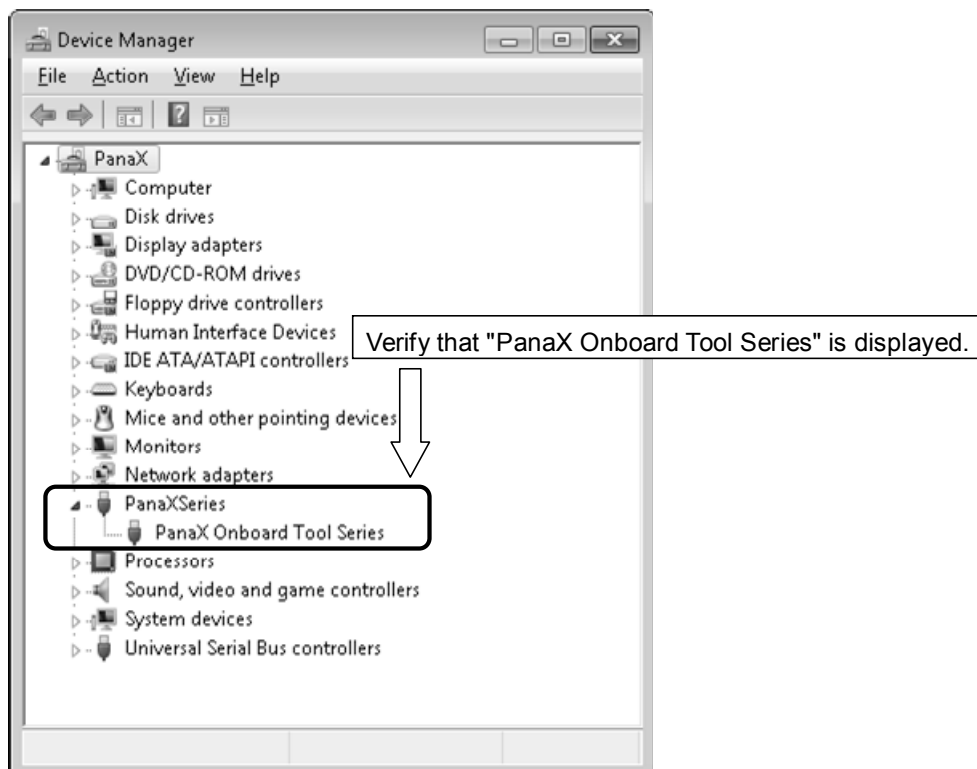

Figure 2.2.5 Device Manager

Note : - Connecting the AM13L-STK2 to another USB port of the host computer or connecting other AM13L-STK2 to the USB port requires new installation of the USB driver.
 - Reinstalling the DebugFactory Builder for MN101_STK2 may require installation of the USB driver.

2.3 Safely Removing Hardware

This section describes how to remove the AM13L-STK2 connected to the host computer.

1. Right-click the [Safely Remove Hardware] icon in the notification area at the far right of the taskbar (the lower right of the screen). If the icon is not found, click the [Show hidden icons] button.

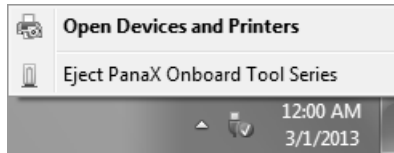

Figure 2.3.1 Eject PanaX Onboard Tool Series

2. Select [Eject PanaX Onboard Tool Series], and verify that the message "The 'PanaX Onboard Tool Series' device can now be safely removed from the computer" is displayed as shown in Figure 2.3.2.

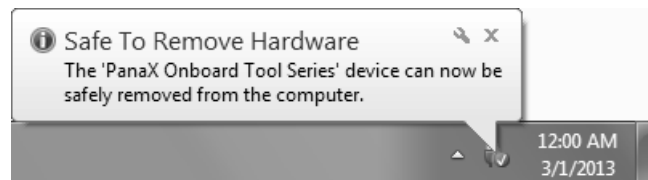

Figure 2.3.2 Safe To Remove Hardware

3. Remove the AM13L-STK2 from the host computer as shown in Figure 2.3.3.

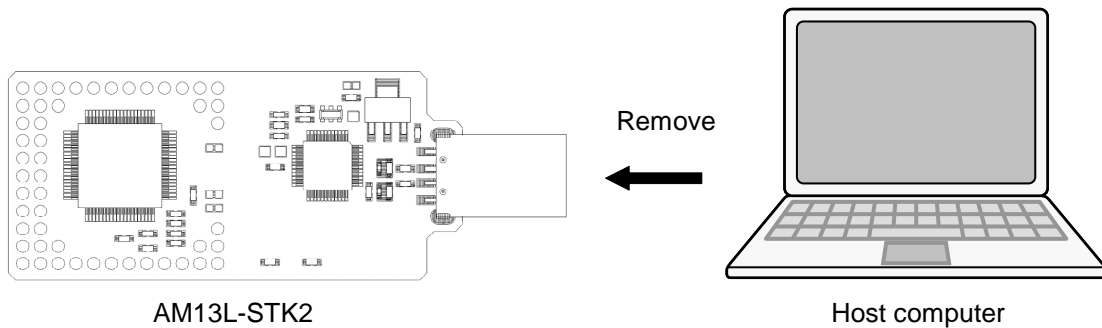

Figure 2.3.3 Removing the AM13L-STK2 from the host computer

2.4 Firmware Update Procedure

With DebugFactory Builder, when the error message "Please update the firmware because the firmware version is older. (Version: X.X.X)" appeared, it is necessary to update the firmware by following the procedures below.

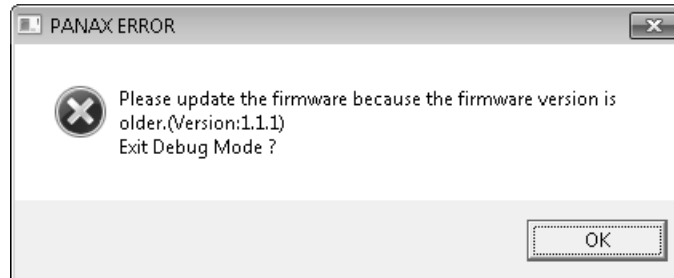

Figure 2.4.1 Firmware Version Error

Note :Once updating the firmware, you can not back to the previous state.

1. The dialog shown in Figure 2.4.2 appears. Click <Yes>.

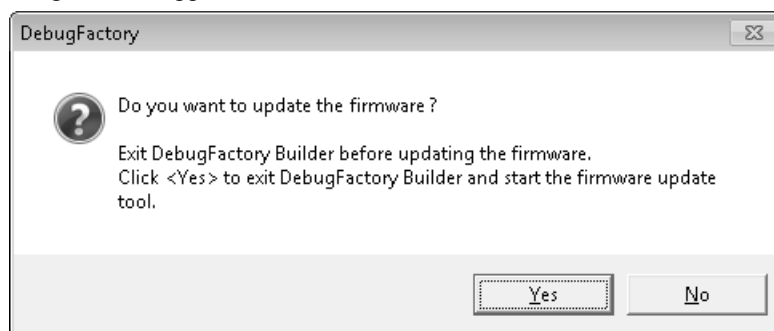

Figure 2.4.2 Firmware Update Start Check

2. The dialog shown in Figure 2.4.3 appears. Click <OK>.

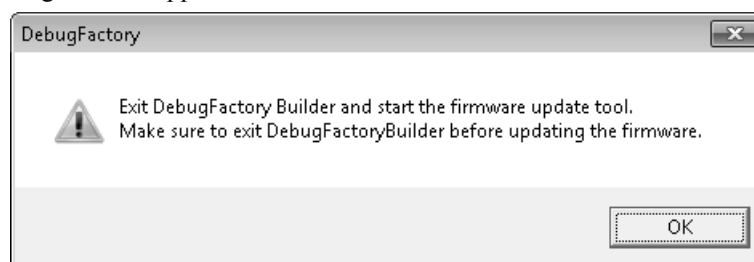

Figure 2.4.3 Firmware Update Tool Start Check

Note : - Do not connect multiple AM13L-STK2 to one host computer when updating the firmware.
 - Never remove the AM13L-STK2 from the host computer during updating the firmware.

3. The dialog shown in Figure 2.4.4 appears. Click <Update>. Click <Exit> to exit the update tool without updating the firmware.

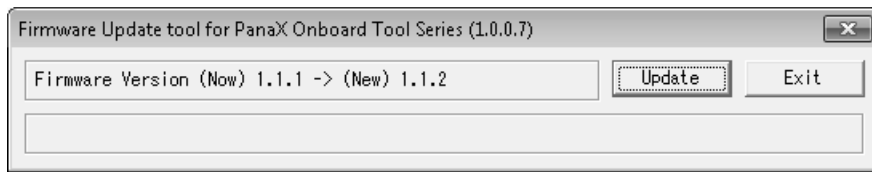

Figure 2.4.4 Startup Window of Firmware Update Tool

4. When <Update> is clicked, the display changes as shown in Figure 2.4.5. Wait until the firmware update has been completed.

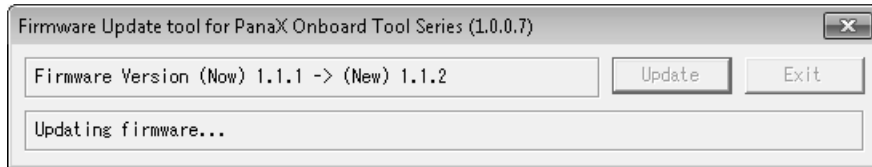

Figure 2.4.5 Firmware Update Tool Updating Screen

5. When the dialog shown in Figure 2.4.6 appears, the update has been completed. When the dialog shown in Figure 2.4.6 doesn't appear after 2 minutes or more, the firmware update has been failed.

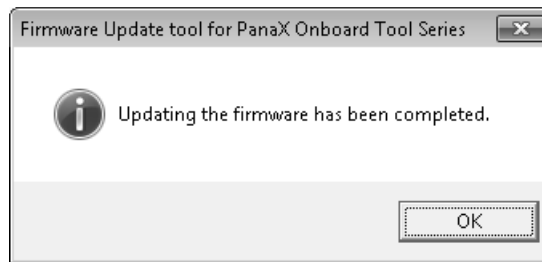

Figure 2.4.6 Completing Firmware Update

Note : In case that the firmware update is failed, remove the AM13L-STK2 from the host computer immediately and contact to inquiries appears at the end of this manual.

2.5 Checking Operations of DebugFactory Builder for MN101_STK2

This section describes procedures for environment setting and checking operations of DebugFactory Builder for MN101_STK2.

■ Startup

From the menu [Start], select [All Program]-[Panasonic DebugFactory Builder 4]-[MN101_STK2], then click [Builder] contained in the [MN101_STK2] group to start up the DebugFactory Builder. (See "Registered [Panasonic DebugFactory Builder 4]-[MN101_STK2] Group" Figure 2.1.9(p.14).) If the software tools have been successfully installed, the startup window in Figure 2.5.1 appears.

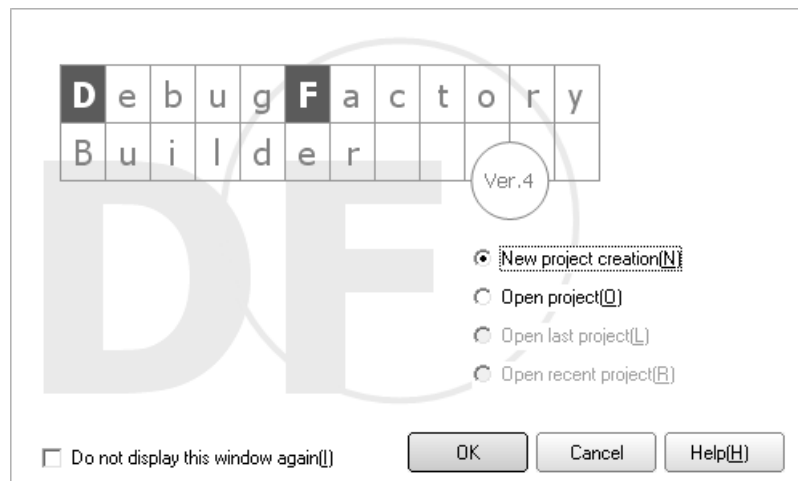

Figure 2.5.1 Startup Window

Create the project and configure the settings to start DebugFactory Builder for MN101_STK2. Those can be easily performed through the [Project creation wizard] dialog.

Select [New project creation] and click <OK> in [Startup window] shown in Figure 2.5.1, and the dialog shown in Figure 2.5.2 appears. Select [Standard], and click <Next>.

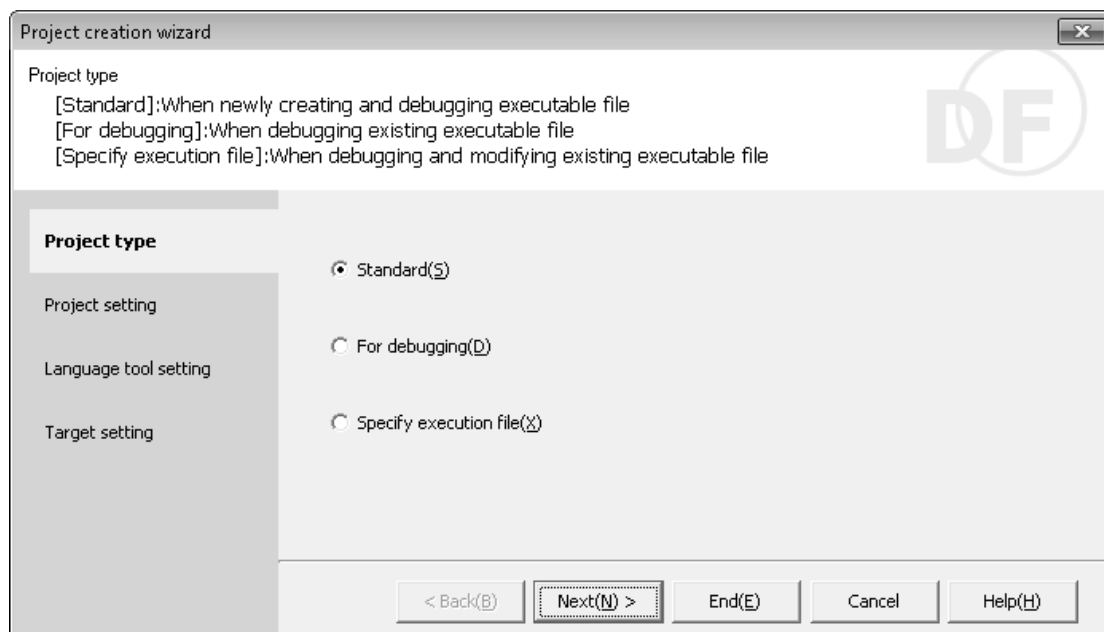

Figure 2.5.2 Project creation wizard

In this wizard, configure the settings for a project to be newly created. Here, configure only project settings to check operations, and use default settings for other items.

- Project name: Specify a project file name.
- Folder to save: Specify a destination folder.
- Source file to be added automatically: Check both [Startup assembler] and [Sample source file].

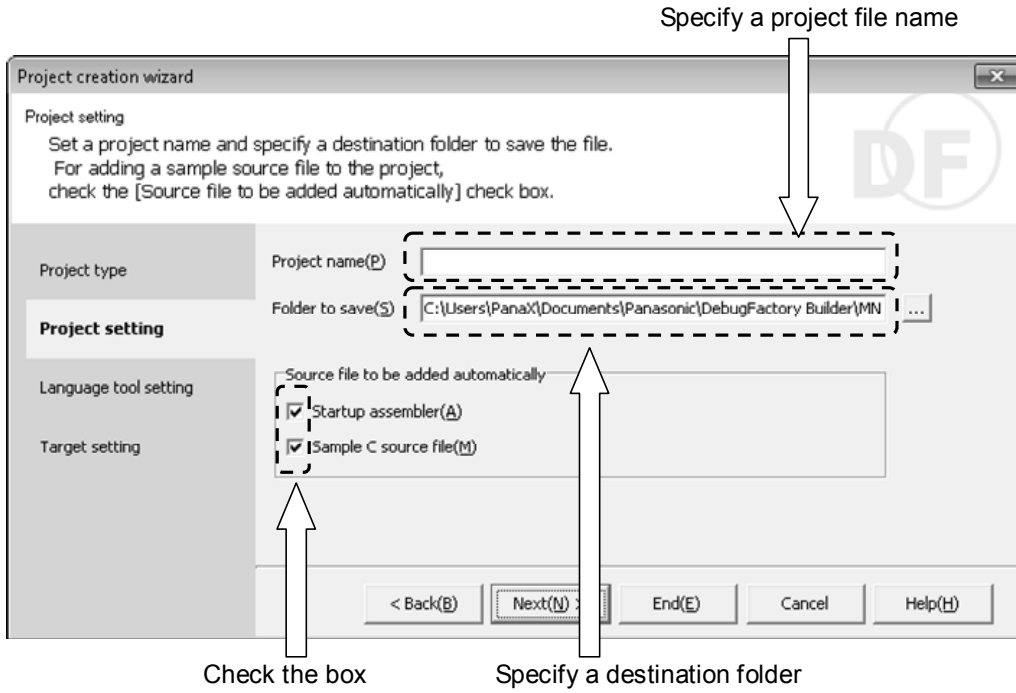

Figure 2.5.3 Project setting

In the Language tool setting, set "Use the built-in language tool" which is an initial value. If other language tools are used, set "Use a following language tool".

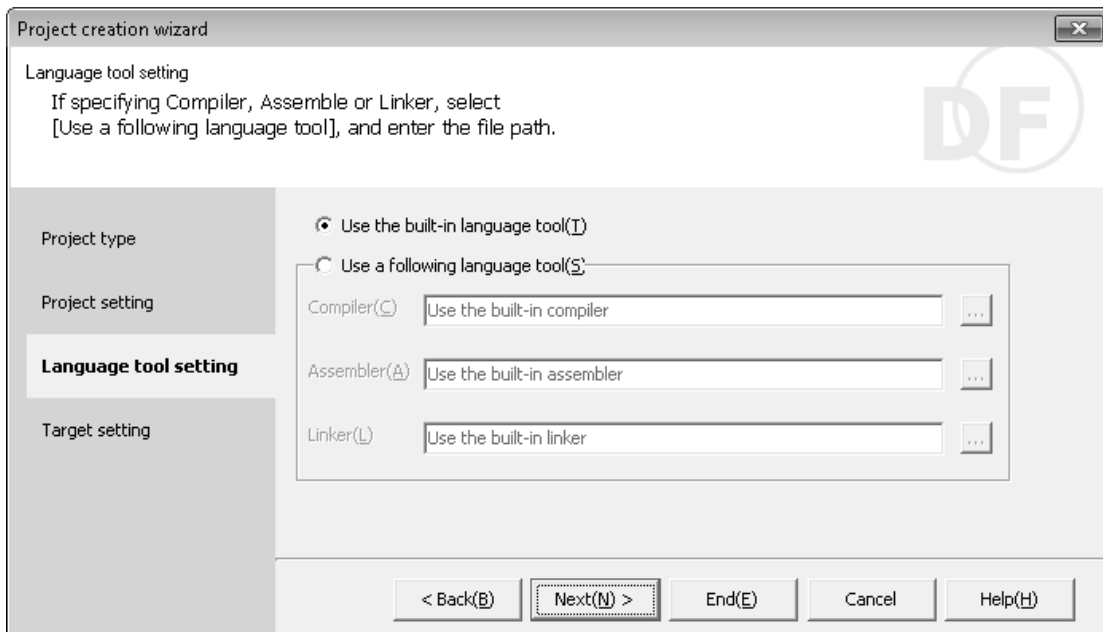

Figure 2.5.4 Language tool setting

The dialog shown in Figure 2.5.5 appears. Click the <Set> button.

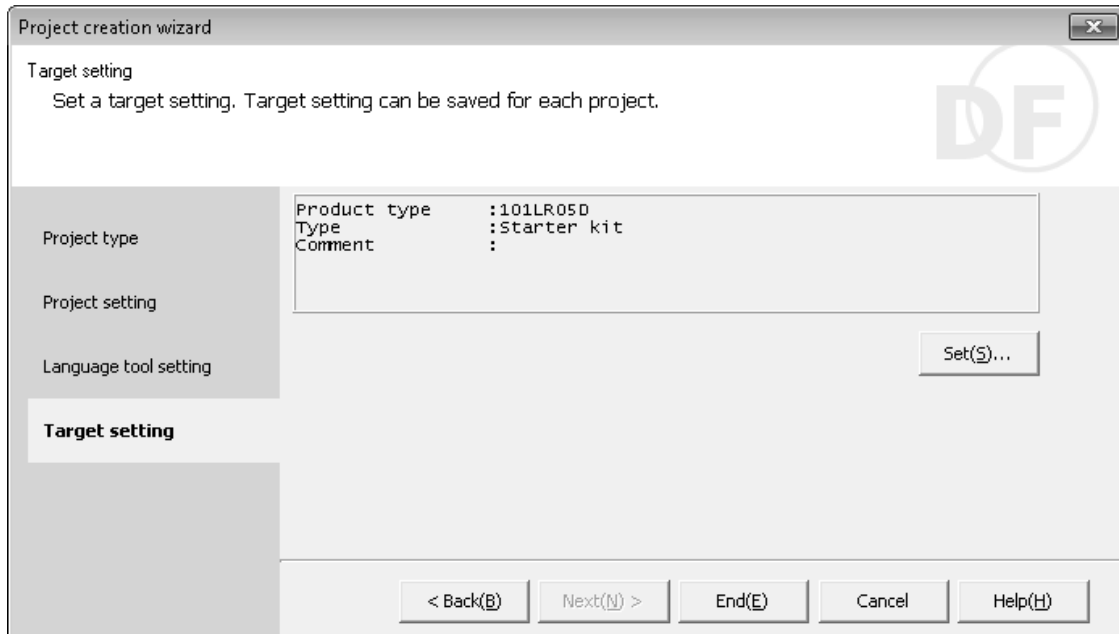

Figure 2.5.5 Target setting

Figure 2.5.6 appears in the <Set> button click.

- Target setting dialog box (Target setting)
 Choose a product type to use. Leave the type of debugging tool "Starter kit". Table 2.5.1 shows the details of each setting item.

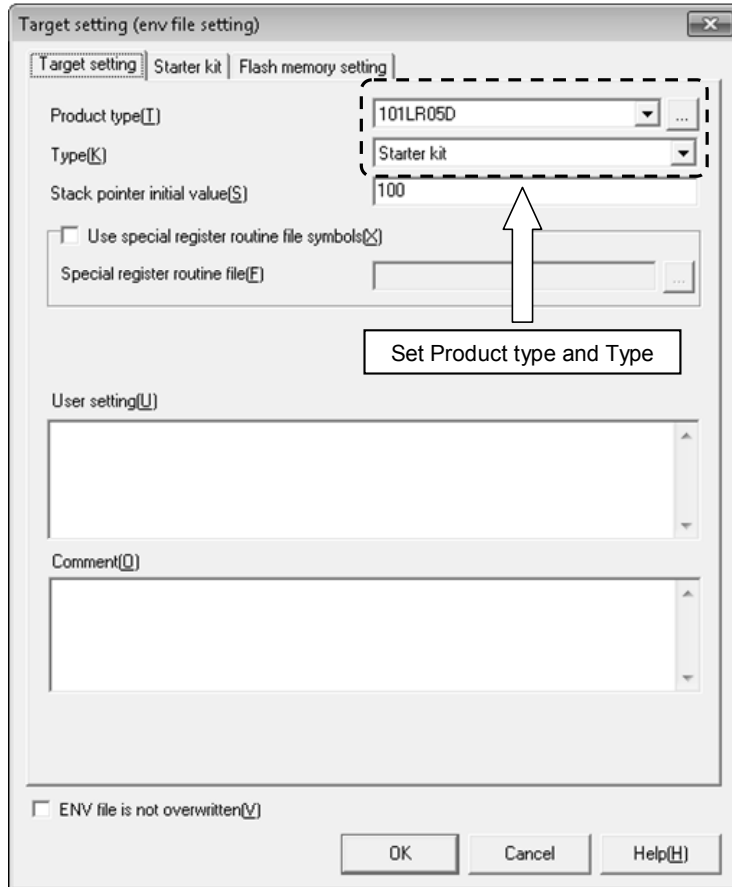

Figure 2.5.6 Target setting dialog box

Table 2.5.1 Target setting dialog (Target setting)

Product type	Select "101LR05D".
Type	Select "Starter kit" as a target type.
Stack pointer initial value	Enters the default stack pointer as a hexadecimal value. If there is no special reason, don't change the setting.
Special register routine file	Special register addresses may be defined as symbols by specifying the file here in some product types. For details, refer to Help on DebugFactory Builder for MN101_STK2.
User setting	Set user original setting that is not included in the target setting dialog. If there is no special reason, it is not necessary to set it.
Comment	Describe comments for the target setting information. If there is no special reason, it is not necessary to set it.

- Target setting dialog box (Starter kit)
Select [Starter kit] tab sheet. The dialog box changes as shown in Figure 2.5.7.
If there is no special reason, don't change the setting.

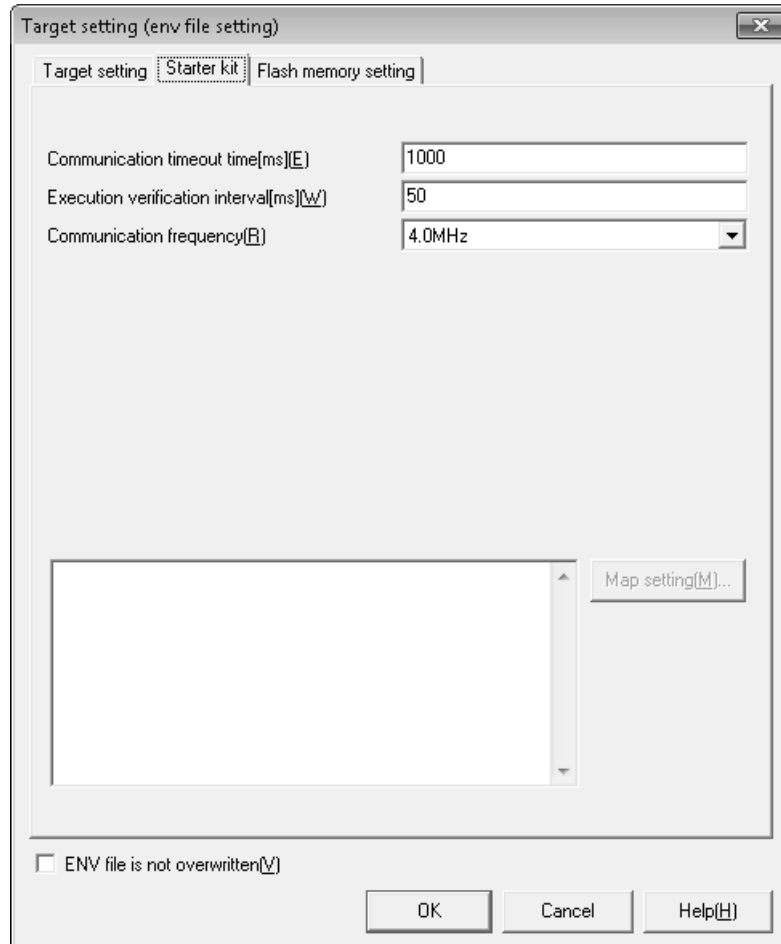

Figure 2.5.7 Starter kit setting

Table 2.5.2 Target Setting Dialog Box (Starter kit)

Communication timeout time	Specify a communication timeout. If there is no special reason, don't change the setting.
Execution verification interval	Specify the interval that the debugger checks states of the microcomputer during program execution. If there is no special reason, don't change the setting.
Communication frequency	Specify the communication frequency of the terminal for exclusive use of the debugging of the AM13L-STK2. If there is no special reason, don't change the setting.

- Target setting dialog box (Flash memory setting)
 Select [Flash memory setting] tab sheet. The dialog box changes as shown in Figure 2.5.8.
 Set about debugging ReRAM.

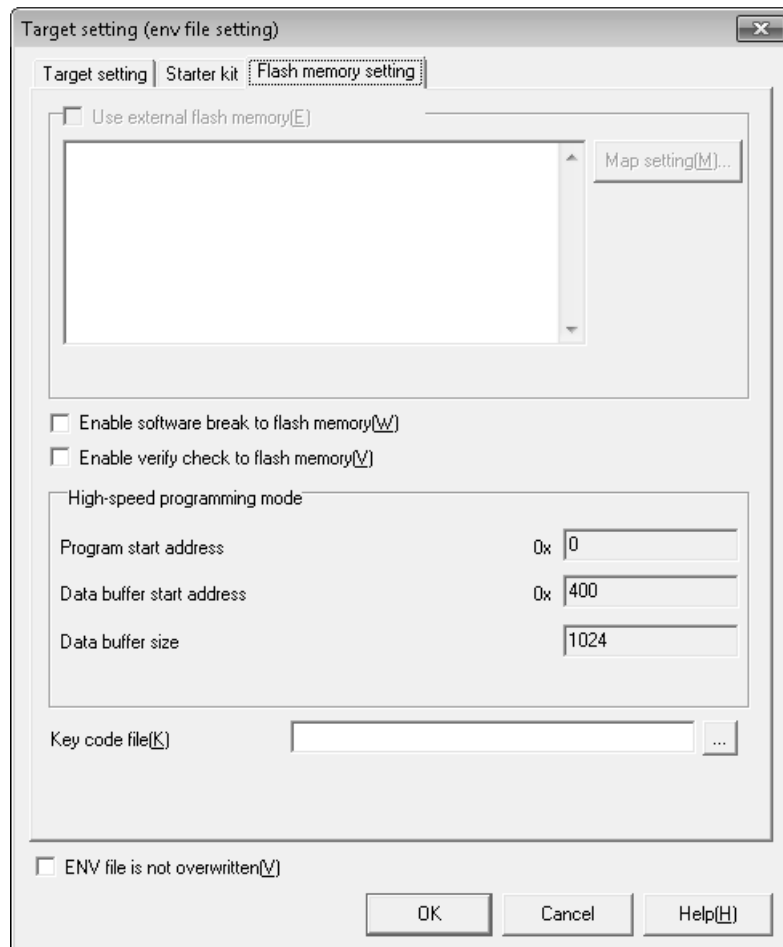

Figure 2.5.8 Flash memory setting

Table 2.5.3 Target Setting Dialog Box (Flash memory setting)

Enable software break to flash memory	Enable the software break function to codes in ReRAM.
Enable verify check to flash memory	Perform verify check at programming to ReRAM.

Click <OK> after setting.

After completing project settings and clicking <End>, the window shown in Figure 2.5.9 appears.

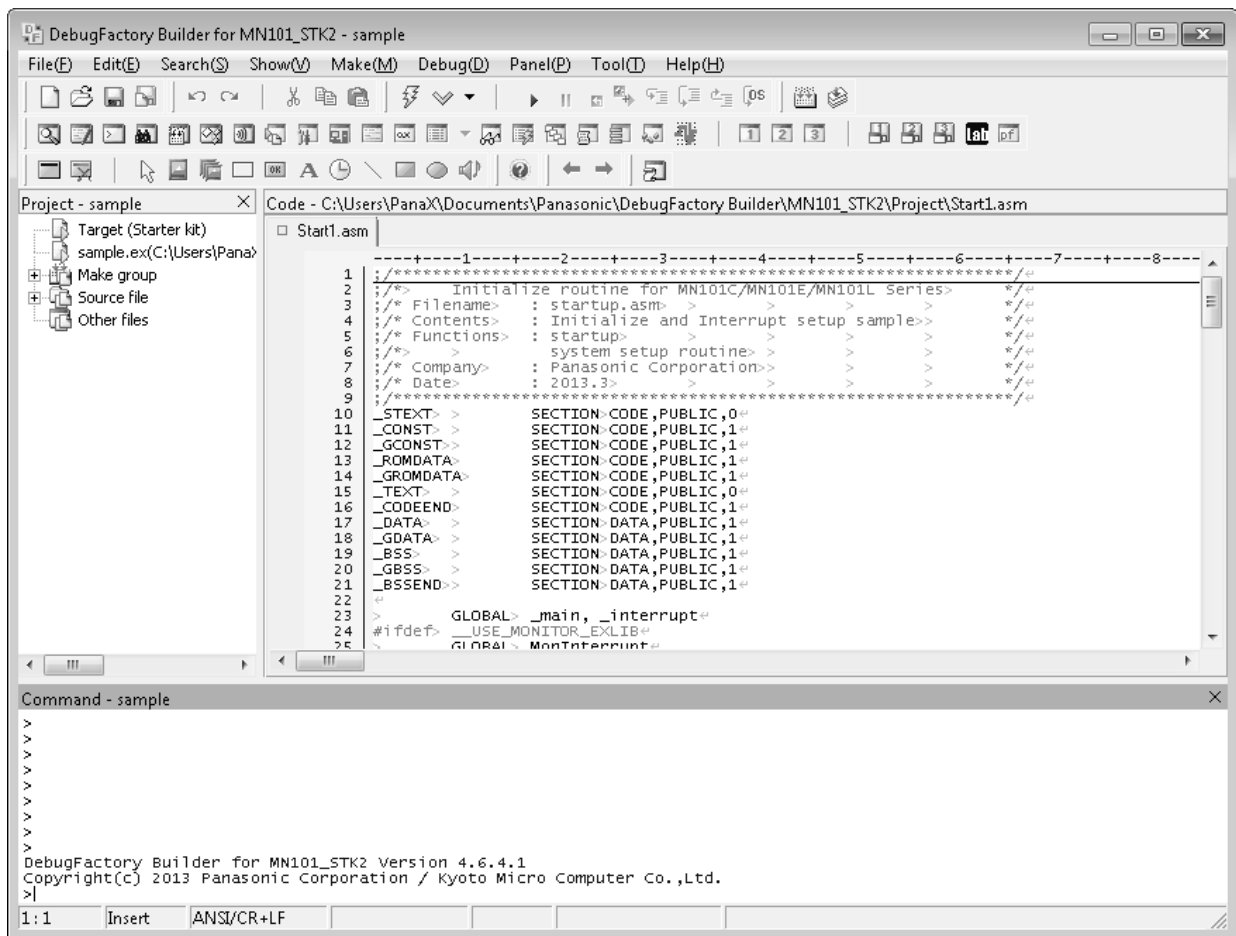

Figure 2.5.9 Startup Window of DebugFactory Builder for MN101_STK2

The startup assembler and the sample source file set in the project creation wizard are added in the project, and the startup assembler is displayed in the [Code] window.

The start-up assembler contains processing indispensable to describe a sample program by the C language using AM13L-STK2.

The sample C source file describes the processing which blinks the green LED (D5) periodically. AM13L-STK2 is shipped in the state that these programs are written in the ReRAM.

■ Make execution

Select [Make]-[Make] in the main menu, then compiling and linking are performed. The message "Execution file has been created" is displayed in the [Make output] window shown in Figure 2.5.10, when the make is completed.

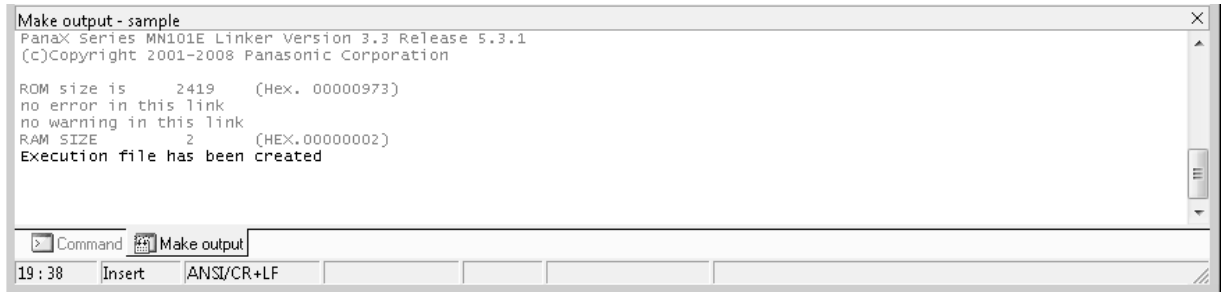

Figure 2.5.10 Make output

■ Verification

Select [Debug]-[Debugging start] in the main menu as shown in Figure 2.5.11. When various settings are performed correctly, the message of "Start of the debug mode" is displayed in the command window as shown in Figure 2.5.12. Then debugging operation such as memory change and execution of the program on the device to be debugged becomes possible. If the command window is not displayed, select [Show]-[Window]-[Command] in the main menu.

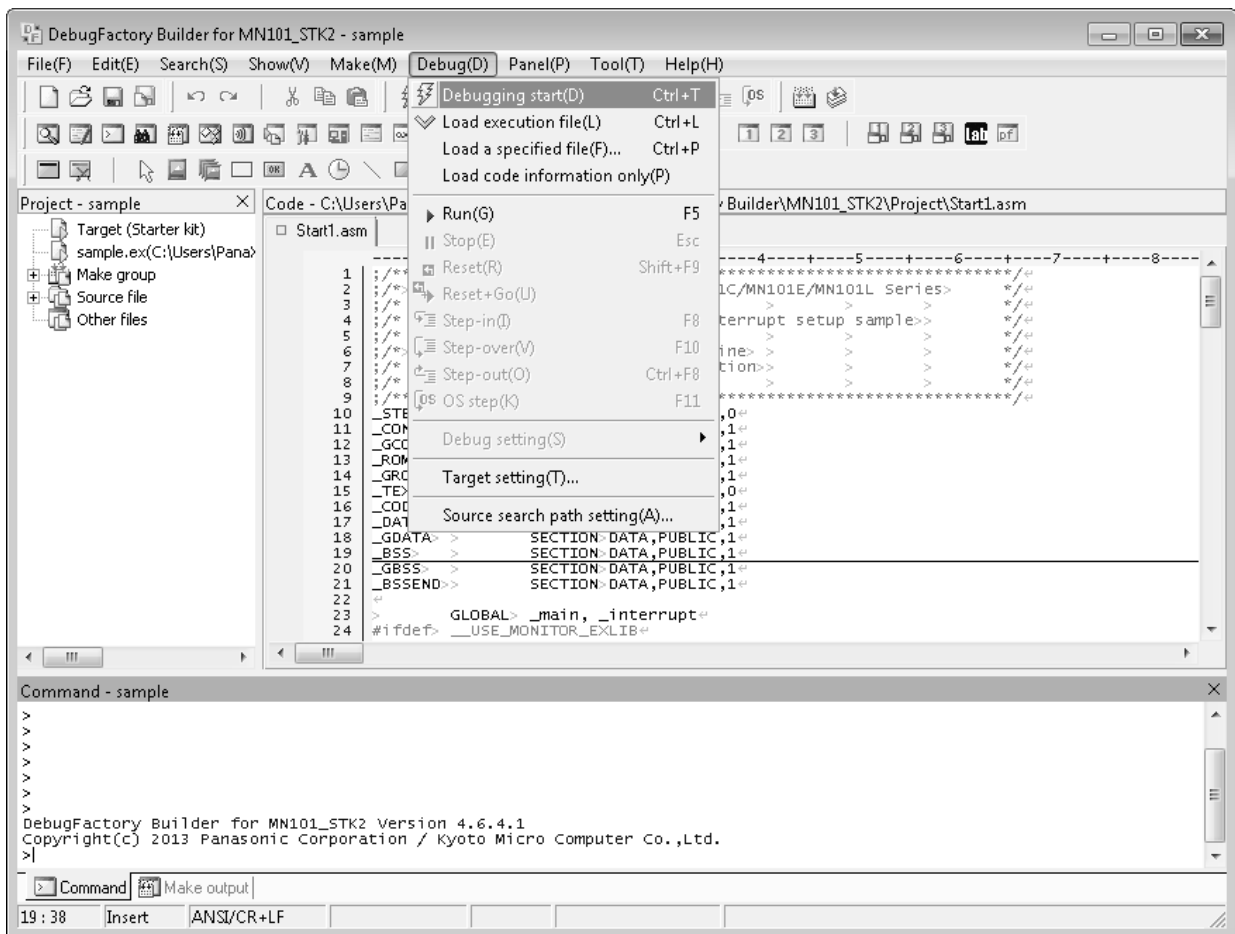

Figure 2.5.11 Selection of [Debugging Start]

If [Debug]-[Debugging end] in the main menu is selected as shown in Figure 2.5.13, the confirmation dialog of the debug mode exit (Figure 2.5.14) is displayed.

When <OK> is clicked, the debug mode is exited.(Figure 1.5.15)

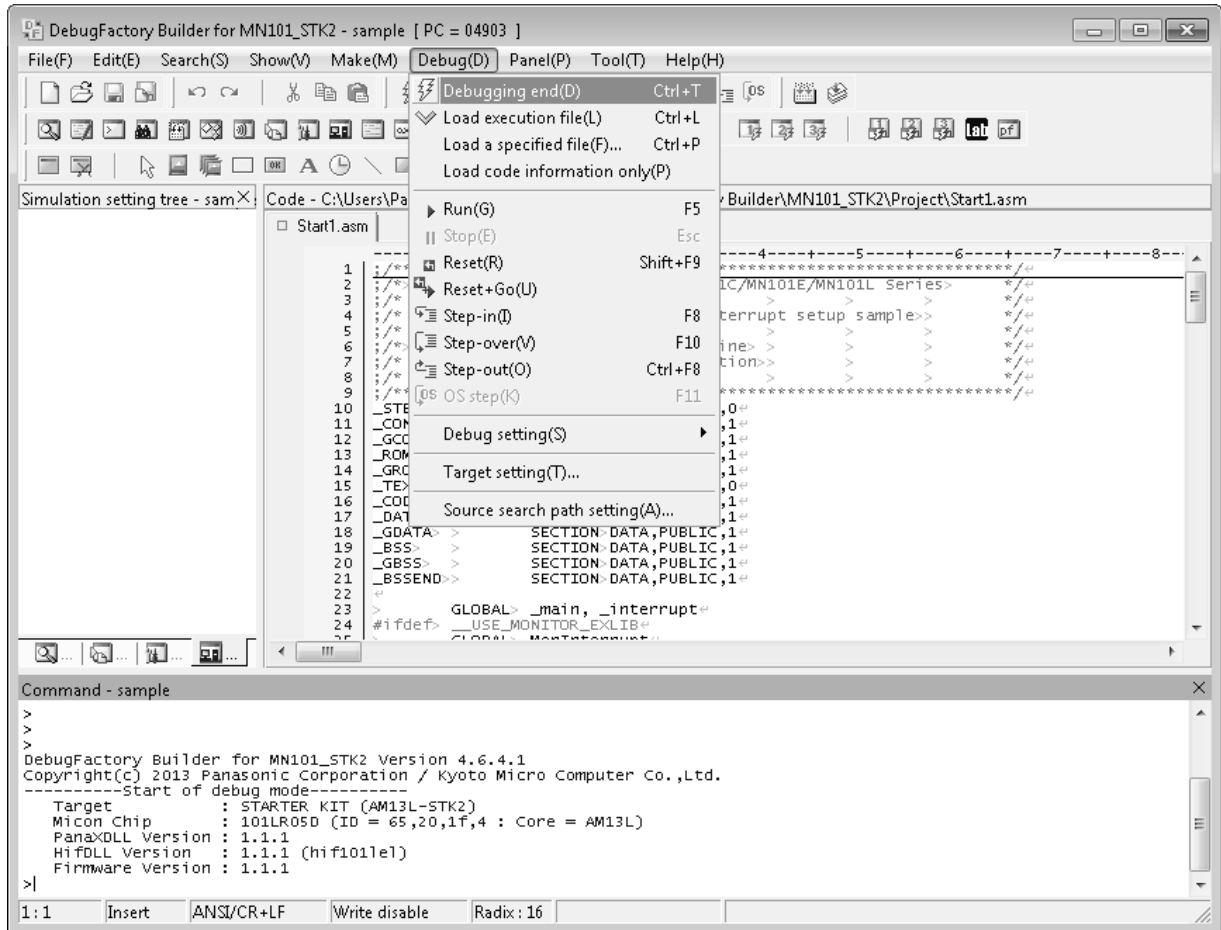

Figure 2.5.13 Selection of [Debugging end]

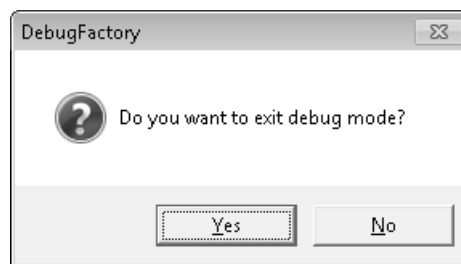
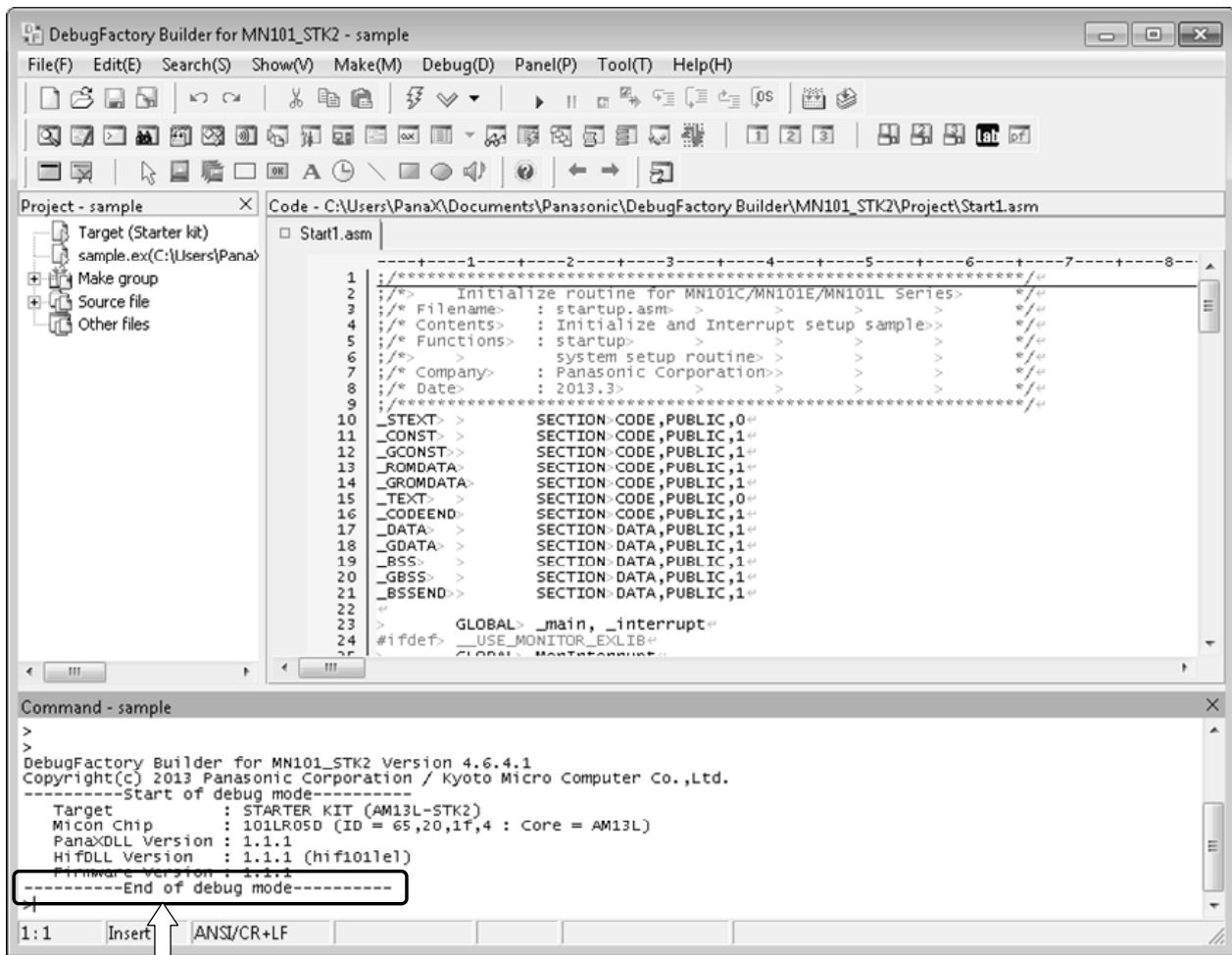

Figure 2.5.14 Confirmation of the Debug Mode Exit



"End of debug mode" is displayed.

Figure 2.5.15 Debug Mode Exit

■ Exit

Select [File]-[Exit] in the main menu to exit the DebugFactory Builder for MN101_STK2.

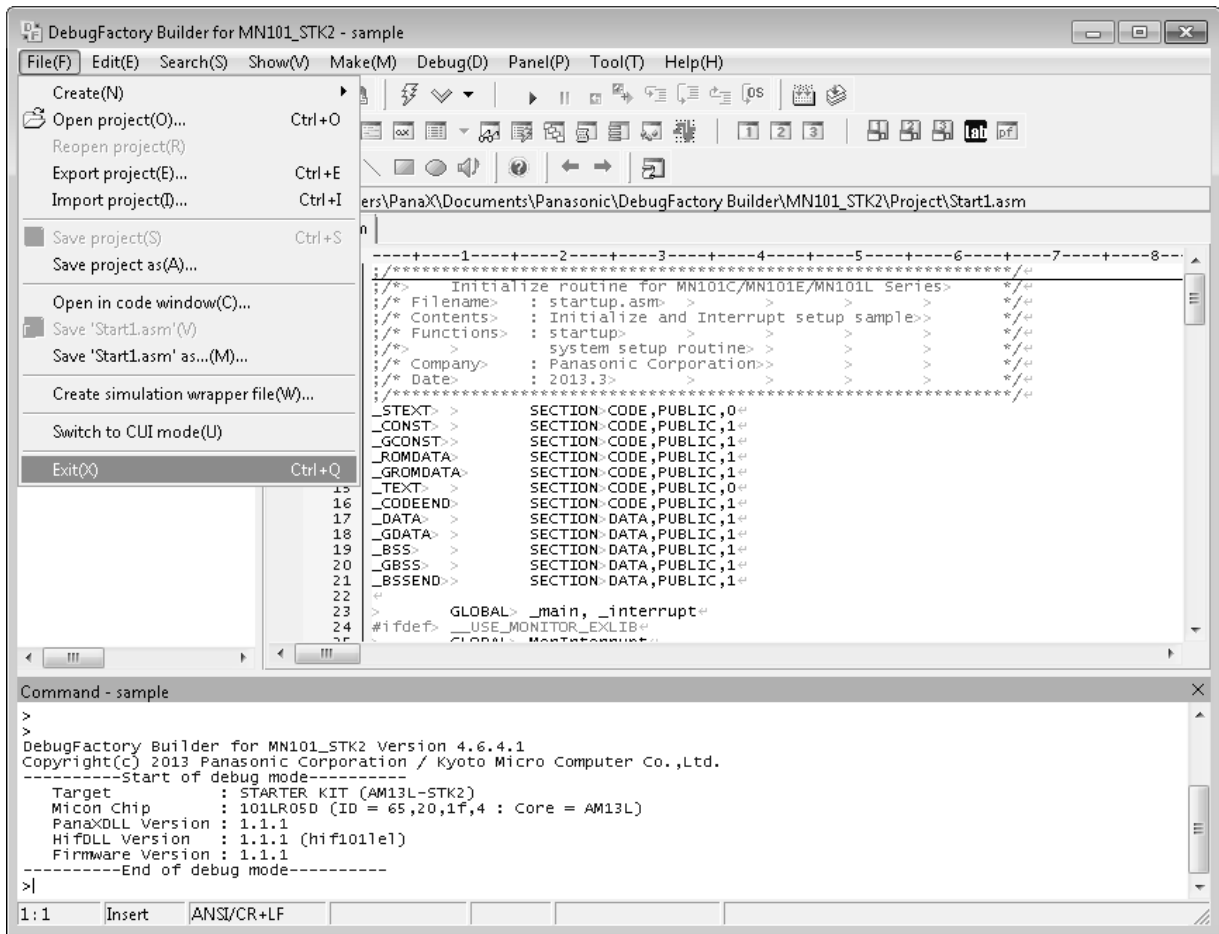

Figure 2.5.16 Exit of DebugFactory Builder for MN101_STK2

Remove AM13L-STK2 from the host computer.

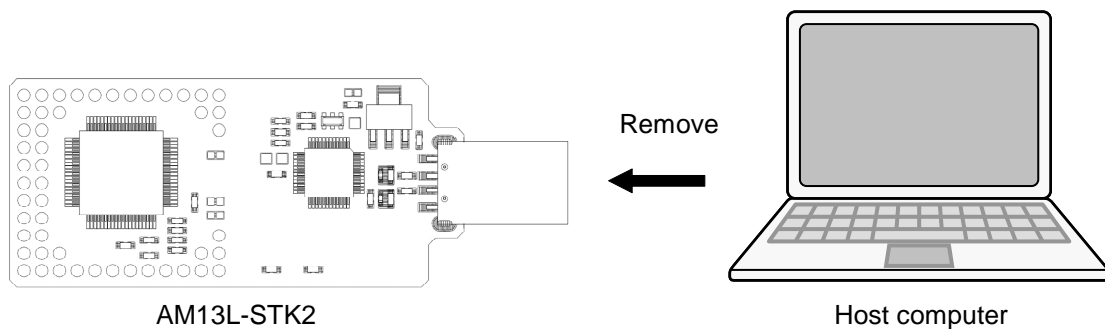

Figure 2.5.17 Removal of AM13L-STK2

2.6 Debug Function List

Table 2.6.1 shows the debug functions of the debugger for AM13L-STK2 (DebugFactory Builder for MN101_STK2).

Table 2.6.1 Debug Function List

Debug function		Description	Debugger for AM13L-STK2
Program load		Writes a user program in a target memory	Yes
Execution	Program execution	Executes normally	Yes
	Microcomputer reset	Resets to a microcomputer	Yes
	Come execution	Executes to the cursor position of the code window	Yes
	Single step execution	Executes step by step in units of a source line or an assembler	Yes
	Function step execution	Executes step by step regarding a subroutine as one step	Yes
Data indication/modification	Dump	Dumps contents of a memory	Yes
	Edit	Modifies contents of a memory to a specified value	Yes
	Edit (ReRAM)	Modifies contents of a ReRAM memory to a specified value	Yes
	Watch	Indicates contents of a memory during program execution in specified form	Conditional*
	Inspect	Indicates in the form according to data structure of a specified variable	Yes
Register indication/modification		Indicates/Modifies contents of a specified register	Yes
RAM monitor		Indicates contents of a memory during program execution by sampling	Conditional*
Back trace		Executes a back trace of a stack frame and indicates a process in which a function has been called	Yes
Break	Forced break	Stops program execution by force	Yes
	Software break	Breaks at a maximum of 256 points	Yes
	Instruction address break	Breaks by address	Yes
	Data access break	Breaks by access width (1/2), address, data, data mask, NOT function	Yes
	Uninstalled instruction	Breaks when an uninstalled instruction is executed	Yes
Profile		Measures the executing frequency of a subroutine/function	Yes
On the fly		Sets a break, refers to a memory, and modifies a memory during program execution	Yes

*somewhat affected to program execution

2.7 Notices for debugging with DebugFactory Builder for MN101_STK2

- Don't remove the AM13L-STK2 while the target is connected in order to avoid improper operation of the debugger. When the debugger operates improperly, remove the AM13L-STK2 and restart DebugFactory Builder for MN101_STK2.

Chapter 3 Hardware

3.1 Part Names and Functions

This section describes part names and functions of AM13L-STK2. Figure 3.1.1 shows a part arrangement plan of AM13L-STK2 on the top view, and Figure 3.1.2 shows a part arrangement plan of AM13L-STK2 on the bottom view.

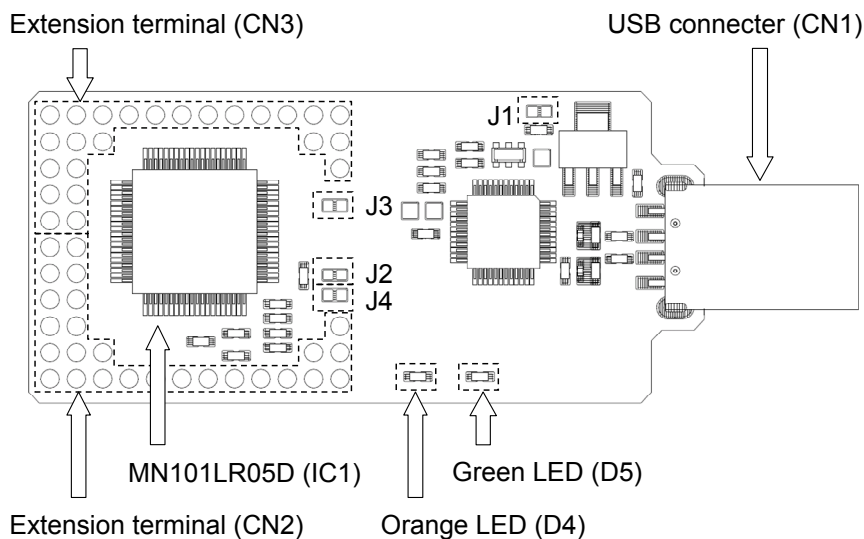

Figure 3.1.1 Part Arrangement Plan (top view)

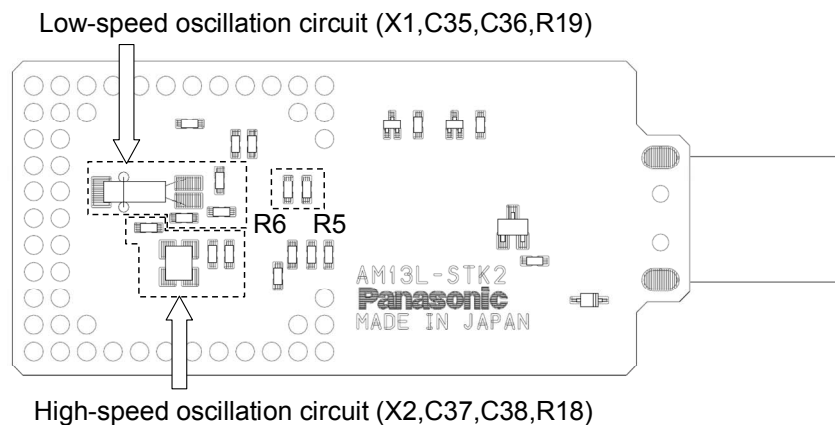

Figure 3.1.2 Part Arrangement Plan (bottom view)

■ MN101LR05D(IC1)

This is a microcomputer with built-in ReRAM to be evaluated.
For characteristics and port control of MN101LR05D, refer to "MN101LR05D LSI User's Manual".

Reset

RC reset circuit by the built-in pull-up resistor of MN101LR05D (IC1) and the capacitor mounted on the board is implemented. The reset period is 500ms.

When a switch reset is required separately, connect it to the No. 6 pin of the extension terminal (CN2).

- Low-speed oscillation circuit (X1, C35, C36, R19)

This is outside low-speed oscillation circuit for MN101LR05D (IC1). Low-speed oscillation circuit is not mounted at board manufacture. Figure 3.1.3 shows a part arrangement plan of low-speed oscillation circuit.

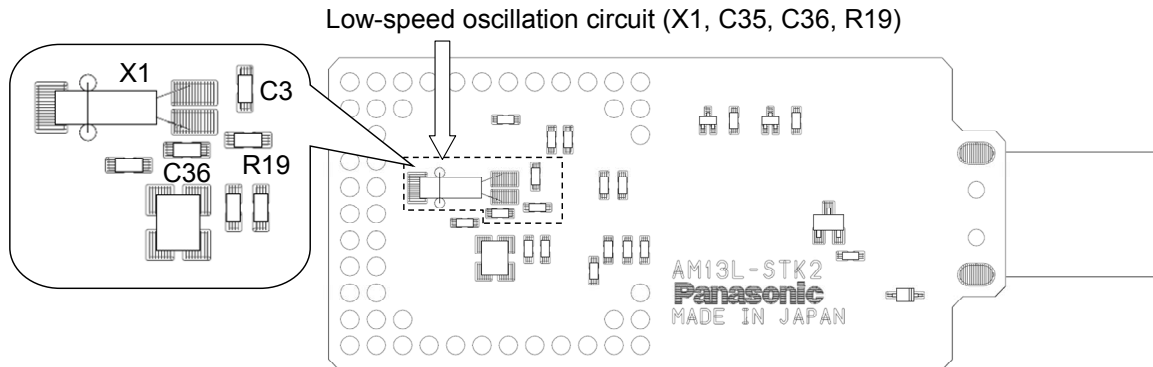

Figure 3.1.3 Part Arrangement Plan of low-speed oscillation circuit

Note :Confirm the frequency accuracy input low-clock depending on the usage of AM13L-STK2.

- High-speed oscillation circuit (X2, C37, C38, R18)

This is outside High-speed oscillation circuit for MN101LR05D (IC1). High-speed oscillation circuit is not mounted at board manufacture. Figure 3.1.4 shows a part arrangement plan of High-speed oscillation circuit.

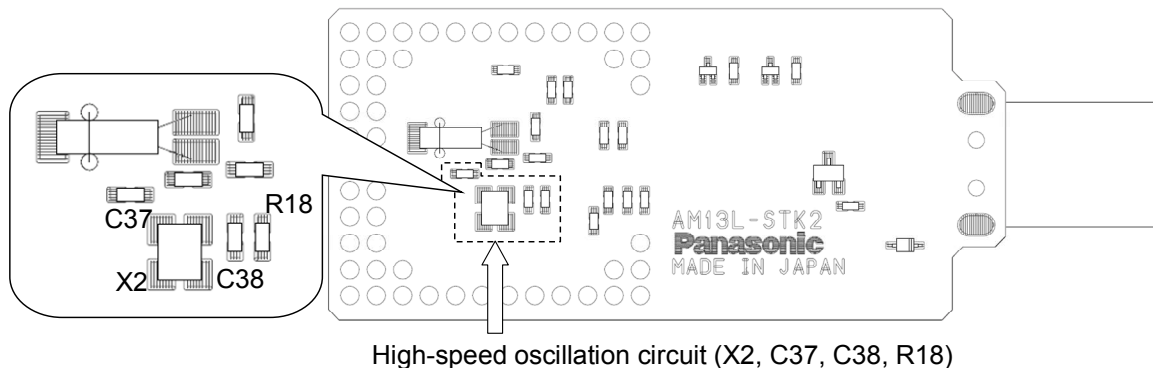

Figure 3.1.4 Part Arrangement Plan of high-speed oscillation circuit

Note :Confirm the frequency accuracy input high-clock depending on the usage of AM13L-STK2.

- LED (D4, D5)

These can be controlled by a user program. Pins of IC1 assigned to D4 and D5 are indicated below.

Orange LED (D4):	No. 8 pin of IC1 (P00/TM9IOC)
Green LED (D5):	No. 9 pin of IC1 (P01/TM4IOC)

- USB connector (CN1)

This is USB series A plug. In addition, AM13L-STK2 is compliant with USB2.0 standard and it supports Full Speed (12 Mbps) as the data transfer rate.

■ Extension terminal (CN2, CN3)

Use these terminals as functional extension terminals. Arrangement of the extension terminals is shown in Table 3.1.1. Table 3.1.2 shows function of extension terminals (CN2), and Table 3.1.3 shows function of extension terminals (CN3).

Through holes of 2.54 mm pitch and $\phi 0.9$ mm hole diameter are prepared for connector mounting. To extend functions by using the extension terminals, refer to "3.3.1 Use of Extension Terminals (p.43)".

Table 3.1.1 Arrangement of Extension Terminals

CN3 15	CN3 14	CN3 13	CN3 12	CN3 11	CN3 10	CN3 9	CN3 8	CN3 7	CN3 6	CN3 5	CN3 4
CN3 18	CN3 17	CN3 16	/	/	/	/	/	/	/	CN3 3	CN3 2
CN3 20	CN3 19	/	/	/	/	/	/	/	/	/	CN3 1
CN3 22	CN3 21	/	/	/	/	/	/	/	/	/	/
CN3 24	CN3 23	/	/	/	/	/	/	/	/	/	/
CN2 26	CN2 25	/	/	/	/	/	/	/	/	/	/
CN2 24	CN2 23	/	/	/	/	/	/	/	/	/	/
CN2 22	CN2 21	/	/	/	/	/	/	/	/	/	/
CN2 20	CN2 19	/	/	/	/	/	/	/	/	/	CN2 1
CN2 18	CN2 17	CN2 16	/	/	/	/	/	/	/	CN2 3	CN2 2
CN2 15	CN2 14	CN2 13	CN2 12	CN2 11	CN2 10	CN2 9	CN2 8	CN2 7	CN2 6	CN2 5	CN2 4

Table 3.1.2 Function of Extension Terminals (CN2)

Pin number	Function
1	VBUS
2	VBUS
3	VDD
4	GND
5	VDD
6	NRST
7	VLC1
8	VLC2
9	VLC3
10	GND
11	P77/COM0
12	P76/COM1
13	P75/COM2
14	P74/COM3
15	GND
16	P67/SEG4/SBCS0A/KEY7B
17	P66/SEG5/SBT0A/KEY6B
18	P65/SEG6/SBO0A/TXD0A/KEY5B
19	P64/SEG7/SBI0A/RXD0A/KEY4B
20	P63/SEG8/IRQ3B
21	P62/SEG9/IRQ2B
22	P61/SEG10/IRQ1B
23	P60/SEG11/IRQ0B
24	P57/TM8IOA/KEY3B/CLKOUTB
25	P56/SEG13/TM3IOA/KEY2B
26	P55/SEG14/TM1IOA/KEY1B

Note :SEG12 of the LCD function connected to extension terminal (CN2) is unusable in AM13L-STK2.
All LCD functions can be used on MN101LR05D provided without AM13L-STK2.

Table 3.1.3 Function of Extension Terminals (CN3)

Pin number	Function
1	P10/A0/KEY0A/IRQ0A
2	P11/A1/KEY1A/IRQ1A
3	P12/A2/KEY2A
4	GND
5	P13/A3/KEY3A
6	VREFP
7	P22/SEG40/SBI2B
8	P23/SEG39/SBO2B/SDA2B
9	GND
10	P24/SEG38/SBT2B/SCL2B
11	P25/SEG37/SBCS2B
12	P26/SEG36/SBI1A/RXD1A
13	P30/SEG35/SBO1A/TXD1A
14	P31/SEG34/SBT1A
15	GND
16	P32/SEG33/SBCS1A
17	P45/SEG22/SBI1B/RXD1B
18	P46/SEG21/SBO1B/TXD1B
19	P50/SEG19/SBCS1B
20	P47/SEG20/SBT1B
21	P52/SEG17/SBO3B/SDA3B
22	P51/SEG18/SBI3B
23	P54/SEG15/SBCS3B/KEY0B
24	P53/SEG16/SBT3B/SCL3B

- **Power supply switching jumper (J1)**

This is a jumper for switching a power supply of the board. When it short-circuits by solder mounting, the USB bus power drive is selected. When it opens by solder un-mounting, the external power drive which supplies a power from the No. 3 pin and No. 5 pin of the extension terminal CN2 is selected. The voltage which can be supplied to AM13L-STK2 from the No. 3 pin and No. 5 pin of the extension terminal CN2 is +1.8 V to +3.6 V.

At board manufacture, the USB bus power drive is selected because it short-circuits. The debugger for AM13L-STK2 (DebugFactory Builder for MN101_STK2) can not be connected when the external power drive is selected. To connect the debugger for AM13L-STK2 (DebugFactory Builder for MN101_STK2), make the power supply switching jumper (J1) short-circuit to select the USB bus power drive.

- **Current measurement jumper (J2)**

This is a jumper for measuring the current consumption of MN101LR05D (IC1). It short-circuits by solder mounting at board manufacture. To measure current, connect an ammeter after removing solder and confirming the polarity of the jumper. Refer to "3.3.2 Current Measurement (p.44)" for how to measure current.

- **Power supply switching jumper for reference voltage of AD converter (J3)**

This is a jumper for switching a power supply of the No. 20 pin (VREFP) of MN101LR05D (IC1). It short-circuits by solder mounting at board manufacture. To supply power from the No. 6 pin of extension terminal (CN3) into the No. 20 pin (VREFP) of MN101LR05D (IC1), make sure to remove a solder before power supply.

- **Power supply switching jumper for LCD (J4)**

This is a jumper for switching a power supply of the No. 77 pin (VLC1) of MN101LR05D (IC1). It short-circuits by solder mounting at board manufacture. To supply power from the No. 7 pin of extension terminal (CN2) into the No. 77 pin (VLC1) of MN101LR05D (IC1), make sure to remove a solder before power supply.

- **Auto reset switching resistances (R5, R6)**

These are resistances for switching an input voltage of the No. 4 pin (NATRON) of MN101LR05D (IC1). To set the auto reset of MN101LR05D (IC1), change the mounting of R5 and R6. Relations of the auto reset and mounting of R5 and R6 are as follows.

Auto reset OFF : R5 mount, R6 unmount

Auto reset ON : R5 unmount, R6 mount

Auto reset is OFF at board manufacture.

3.2 Debugger Connection

For debugging and programming by AM13L-STK2, installation of the debugger for AM13L-STK2 (DebugFactory Builder for MN101_STK2) is needed. Refer to the software chapter for the installation method. Figure 3.2.1 shows the example of connection of the debugger for AM13L-STK2 (DebugFactory Builder for MN101_STK2). To connect the debugger for AM13L-STK2 (DebugFactory Builder for MN101_STK2), confirm that the power supply switching jumper (J1) short-circuits, and connect AM13L-STK2 to the USB port of the host computer.

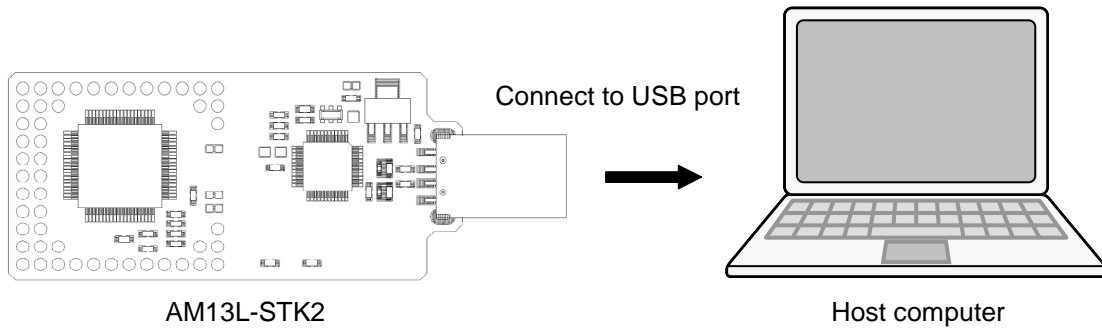

Figure 3.2.1 Example of Connection of the Debugger for AM13L-STK2

3.3 Customization of AM13L-STK2

This section describes functional extension of AM13L-STK2 and customization at evaluation.

3.3.1 Use of Extension Terminals

This section describes cautions at use of the extension terminals (CN2, CN3) and at creation of an extension board by the user.

- **Cautions at Extension Terminal Mounting**

Mount connectors of 2.54 mm pitch on CN2 and CN3.

- **Power Supply from AM13L-STK2 to the Extension Board**

AM13L-STK2 can supply the voltage of +5.0 V (VBUS) from No. 1 pin and No. 2 pin of CN2, and the voltage of +3.3 V from No. 3 pin and No. 4 pin of CN2. The total output current of +5.0 V and +3.3 V is a maximum of 500 mA including the current consumption of AM13L-STK2.

- **Power Supply from the Extension Board to AM13L-STK2**

AM13L-STK2 can operate by the power supply from the extension board. When the extension board supplies the operation power to AM13L-STK2, make the power supply switching jumper (J1) open, and make No.3 pin and No.5 pin of CN2 supply a voltage of +1.8 V to +3.6 V. The power supply to +3.3 V regulator (IC3) stops by making the power supply switching jumper (J1) open.

- **Power supply from the extension board to reference voltage of AD converter**

When the extension board supplies the reference voltage of AD converter to AM13L-STK2, open the power supply switching jumper for reference voltage of AD converter (J3). Supply the reference voltage from No.6 pin of CN3. Reference voltage for AD converter of AM13L-STK2 make less than or equal the operating voltage of MN101LR05D (IC1).

- **Power supply from the extension board to LCD**

When the extension board supplies a power to the No.77 pin (VLC1) of MN101LR05D (IC1), open the Power supply switching jumper for LCD (J4).

- **Reset signal input from the extension board**

When the extension board input the reset signal to No. 5 pin (NRST) of MN101LR05D (IC1), make the reset signal from the extension board into open-drain output.

3.3.2 Current Measurement

This section describes how to measure current consumed by MN101LR05D (IC1). The current measurement jumper (J2) which can measure the current consumption of MN101LR05D (IC1) is prepared on the board of AM13L-STK2. To measure current, remove the solder of a current measurement jumper (J2) to open, and connect an ammeter. Figure 3.3.1 shows the polarity of the current measurement jumper (J2).

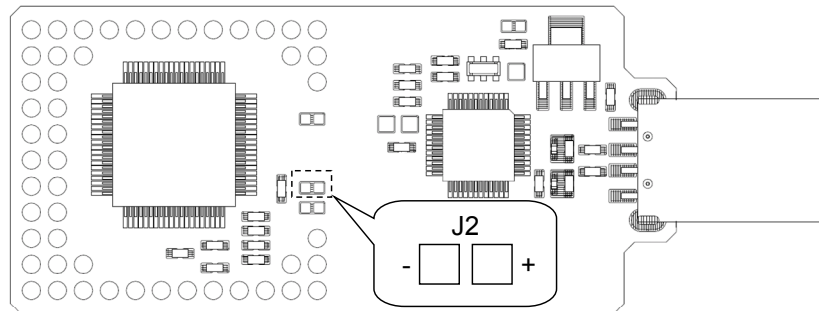

Figure 3.3.1 Polarity of the Current Measurement Jumper (J2)

Using the current measurement jumper (J2) can measure the sum of the core current consumption and the IO current consumption.

Chapter 4 Appendix

4.1 Circuit Diagram

Figure 4.1.1 shows the circuit diagram of AM13L-STK2.

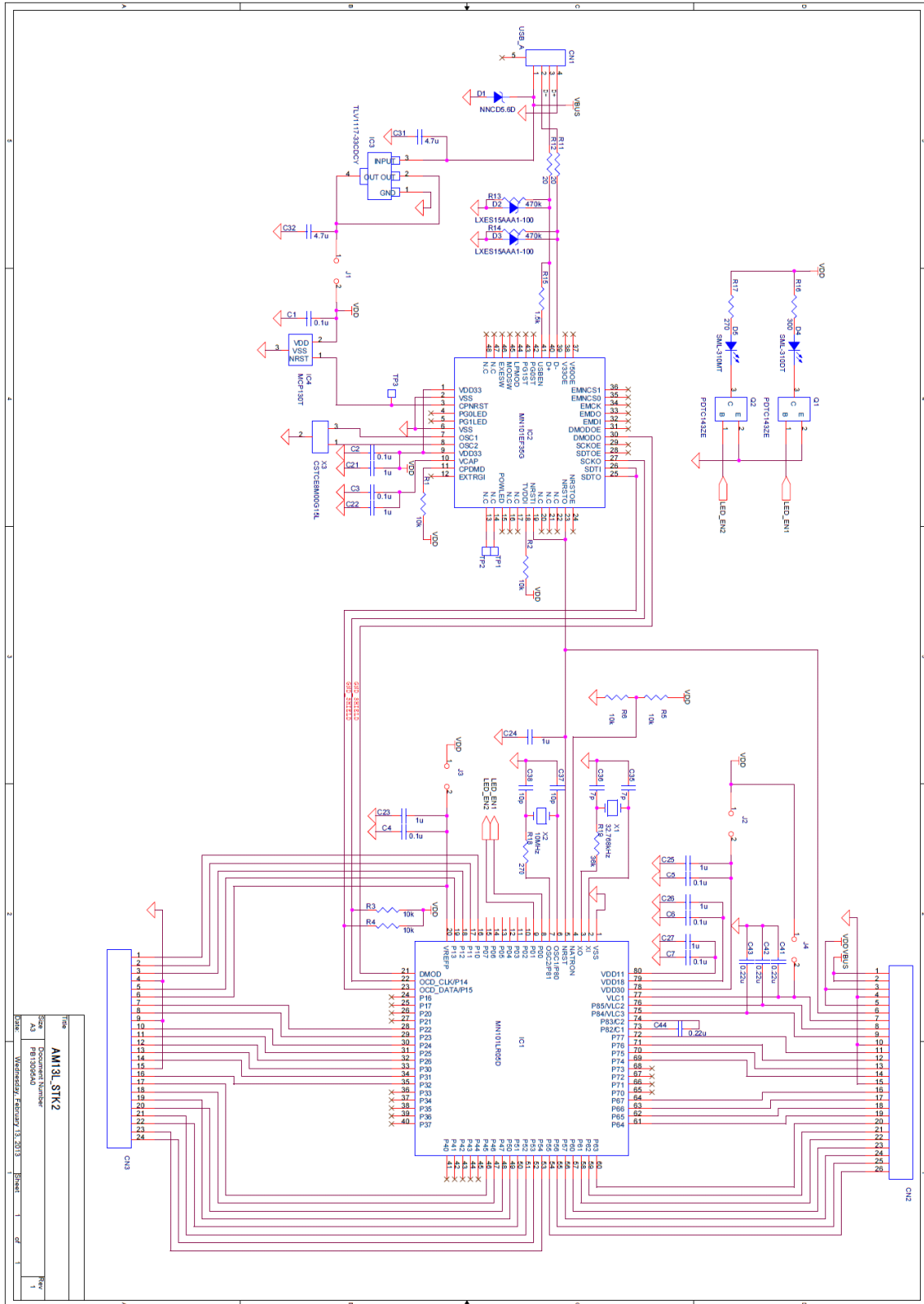

Figure 4.1.1 Circuit Diagram of AM13L-STK2

4.2 Part List

Table 4.2.1 shows the part list of AM13L-STK2.

Table 4.2.1 Part List of AM13L-STK2

Part Number	Function	Model number	Maker	Package size	Number	Mounting
IC1	Microcomputer	MN101LR05D	Panasonic	TQFP80-P-1212	1	Yes
IC2	USB-DWire converter IC	MN101EF35G	Panasonic	HQFP048-P-0707B	1	Yes
IC3	+3.3 V regulator	TLV1117-33CDCYR	TI	SOT-223	1	Yes
IC4	Reset IC	MCP130T-300I/TT	MICRO CHIP	SOT23-3	1	Yes
Q1, Q2	Digital Transistor	PDTC143ZE	NXP	SC-75	2	Yes
X1	Crystal Resonator for MN101LR05D (Low-speed) CL=6pF	DT-26	DAISHINKU	Cylinder type	1	No
X2	Crystal Unit for MN101LR05D (High-speed)	CX3225GB10000D0HEQZ1	KYOCERA	3.20 mm x 2.50 mm	1	No
X3	Resonator for USB-DWire converter IC (8MHz)	CSTCE8M00G15L	MURATA	3.2 mm x 1.3 mm	1	Yes
D1	ESD protection diode for USB power	NNCD5.6D-T1	NEC	1.6 mm x 0.8 mm	1	Yes
D2, D3	ESD protection diode for USB data	LXES15AAA1-100	MURATA	1.0 mm x 0.5 mm	2	No
D4	LED (Orange)	SML-310DT	ROHM	1.6 mm x 0.8 mm	1	Yes
D5	LED (Green)	SML-310MT	ROHM	1.6 mm x 0.8 mm	1	Yes
CN1	USB-A (male)	A-USB A-LP-SMT	ASSMANN	20.30 mm x 12 mm	1	Yes
CN2	Extension connector (26 pin)	-	-	2.54 mm pitch pin header	1	No
CN3	Extension connector (24 pin)	-	-	2.54 mm pitch pin header	1	No
R1 - R5	10 k Ω resistor	-	-	1.6 mm x 0.8 mm	5	Yes
R6	10 k Ω resistor	-	-	1.6 mm x 0.8 mm	1	No
R11, R12	20 Ω resistor	-	-	1.6 mm x 0.8 mm	2	Yes
R13, R14	470 k Ω resistor	-	-	1.6 mm x 0.8 mm	2	Yes
R15	1.5 k Ω resistor	-	-	1.6 mm x 0.8 mm	1	Yes
R16	300 Ω resistor	-	-	1.6 mm x 0.8 mm	1	Yes
R17	270 Ω resistor	-	-	1.6 mm x 0.8 mm	1	Yes
R18	270 Ω resistor	-	-	1.6 mm x 0.8 mm	1	No
R19	36 k Ω resistor	-	-	1.6 mm x 0.8 mm	1	No
C1 - C7	0.11 uF ceramic capacitor	-	-	1.6 mm x 0.8 mm	7	Yes
C21 - C27	1 uF ceramic capacitor	-	-	1.6 mm x 0.8 mm	7	Yes
C31, C32	4.7 uF ceramic capacitor	-	-	1.6 mm x 0.8 mm	2	Yes
C35, C36	7 pF ceramic capacitor	-	-	1.6 mm x 0.8 mm	2	No
C37, C38	10 pF ceramic capacitor	-	-	1.6 mm x 0.8 mm	2	No
C41 - C44	0.22 uF ceramic capacitor	-	-	1.6 mm x 0.8 mm	4	Yes

4.3 Dimensions

Figure 4.3.1 shows the board dimensional drawing of AM13L-STK2. All units are millimeters.

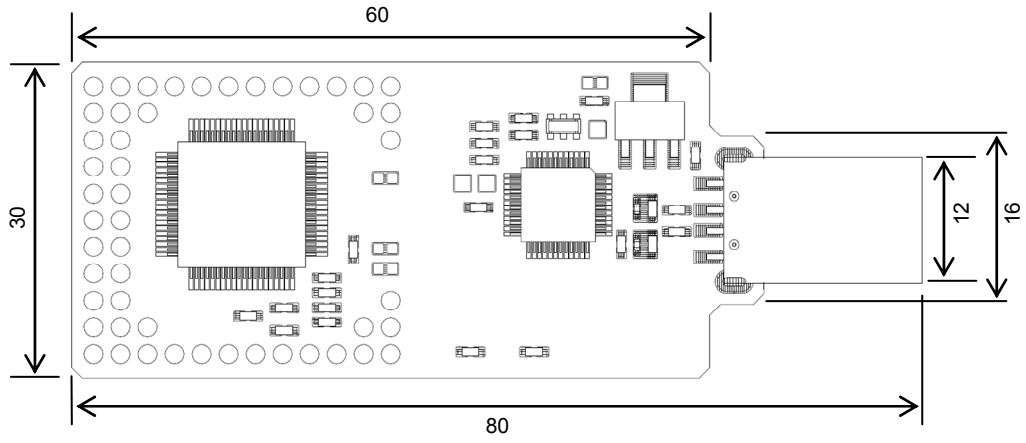

Figure 4.3.1 Dimensional Drawing of AM13L-STK2

Record of Changes

AM13L-STK2 Installation Manual Record of Changes

Revised on April 26, 2013

Definition	Previous Edition (---)			New Edition (1.1)
	Page	Section	Details of Changes	Details of Changes
New	--	--	---	New making of the manual

Revised on September 2, 2013

Definition	Previous Edition (1.1)			New Edition (1.2)
	Page	Section	Details of Changes	Details of Changes
Change	8	29	LCD control terminal: 31 pins (4COM/27SEG)	LCD control terminal: 30 pins (4COM/26SEG)
Change	16	Figure 2.2.1	---	Replaced a figure
Change	18	Figure 2.3.3	---	Replaced a figure
Change	32	Figure 2.5.17	---	Replaced a figure
Change	39	Table 3.1.2	P57/SEG12/TM8IOA/KEY3B/CLKO UTB	P57/TM8IOA/KEY3B/CLKOUTB
Add	39	30	---	Note: SEG12 of the LCD function connected to extension terminal (CN2) is unusable in AM13L-STK2. All LCD functions can be used on MN101LR05D provided without AM13L-STK2.
Change	42	Figure 3.2.1	---	Replaced a figure

Inquiries

If you have questions regarding technical information on this manual, please visit the following URL.

Panasonic Corporation

URL: <http://www.semicon.panasonic.co.jp/en>

- Microcomputer Home Page
<http://www.semicon.panasonic.co.jp/e-micom>

AM13L-STK2 Installation Manual

September 2, 2013 1st Edition 2nd Printing

Issued by
Panasonic Corporation

© Panasonic Corporation 2013

Semiconductor Business Division
Automotive & Industrial Systems Company
Panasonic Corporation

1 Kotari-yakemachi, Nagaokakyo City, Kyoto
617-8520, Japan
Tel : 81-75-951-8151

<http://www.semicon.panasonic.co.jp/en>

010413
Printed in Japan