

Features

- High reliability LED package
- Ideal for indication light on hand held products
- Long life and robust package
- Variety of lens types and color choices available
- Package : 2000pcs / reel
- Moisture sensitivity level : level 3
- RoHS compliant



Applications

- Traffic signaling.
- Backlighting (illuminated advertising , general lighting).
- Interior and exterior automotive lighting.
- Substitution of micro incandescent lamps.
- Reading lamps.
- Signal and symbol luminaire for orientation.
- Marker lights (e.g. Steps, exit ways, etc).
- Decorative and entertainment lighting.
- Indoor and outdoor commercial and residential architectural lighting.

Package Schematics

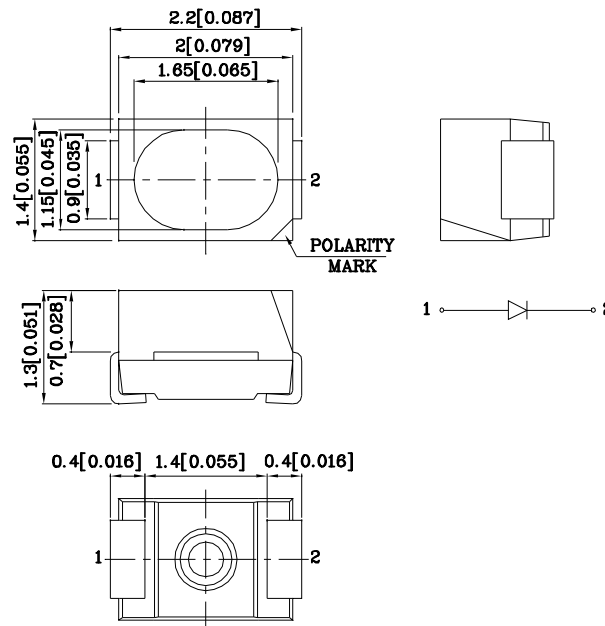

Notes:

1. All dimensions are in millimeters (inches).
2. Tolerance is ± 0.2 (0.008") unless otherwise noted.
3. Specifications are subject to change without notice.

Handling Precautions

Compare to epoxy encapsulant that is hard and brittle, silicone is softer and flexible. Although its characteristic significantly reduces thermal stress, it is more susceptible to damage by external mechanical force.

As a result, special handling precautions need to be observed during assembly using silicone encapsulated LED products. Failure to comply might lead to damage and premature failure of the LED.

1. Handle the component along the side surfaces by using forceps or appropriate tools.

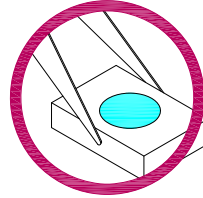

2. Do not directly touch or handle the silicone lens surface. It may damage the internal circuitry.

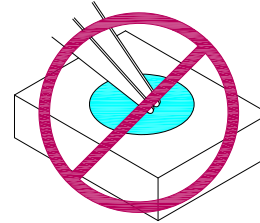
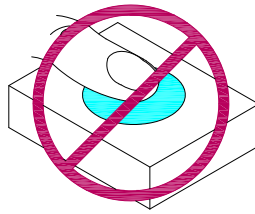

3. Do not stack together assembled PCBs containing exposed LEDs. Impact may scratch the silicone lens or damage the internal circuitry.

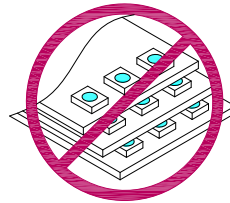

- 4.1. The inner diameter of the SMD pickup nozzle should not exceed the size of the LED to prevent air leaks.
- 4.2. A pliable material is suggested for the nozzle tip to avoid scratching or damaging the LED surface during pickup.
- 4.3. The dimensions of the component must be accurately programmed in the pick-and-place machine to insure precise pickup and avoid damage during production.

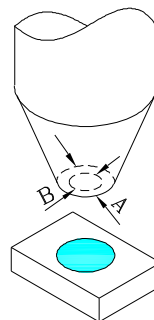

5. As silicone encapsulation is permeable to gases, some corrosive substances such as H_2S might corrode silver plating of leadframe. Special care should be taken if an LED with silicone encapsulation is to be used near such substances.

Part Number	Dice	Lens-color	Luminous Intensity CIE127-2007* (IF=20mA) mcd			Viewing Angle 2θ 1/2[1]
			Code.	min.	max.	
XZMDK80S-2HTA	Red (AlGaInP)	Water Clear	P	200	300	120°
			Q	300	400	
			R	400	500	
			H*	55*	80*	
			M*	80*	120*	
			N*	120*	200*	

Note:

1. 01/2 is the angle from optical centerline where the luminous intensity is 1/2 of the optical peak value.
- * luminous intensity value is in accordance with CIE127-2007 standards.

Absolute Maximum Ratings at Ta=25°C

Parameter	Symbol	Value	Unit
Power dissipation	PD	75	mW
Reverse Voltage	VR	5	V
Junction temperature[1]	TJ	115	°C
Operating Temperature	Top	-40 To +100	°C
Storage Temperature	Tstg	-40 To +115	°C
DC Forward Current[1]	IF	30	mA
Peak Forward Current [2]	IFM	185	mA
Electrostatic Discharge Threshold (HBM)		3000	V
Thermal Resistance (Junction/ambient) [1]	Rth j-a	540	°C/W

Notes:

1. Rth(j-a) Results from mounting on PC board FR4 (pad size≥16 mm² per pad),
2. 1/10 Duty Cycle, 0.1ms Pulse Width.

Electrical / Optical Characteristics at Ta=25°C

Parameter	Symbol	Value	Unit
Wavelength at peak emission IF=20mA CIE127-2007* [Typ.]	λpeak	645*	nm
Dominant Wavelength IF=20mA CIE127-2007* [Min.]	λ dom [1]	620*	nm
Dominant Wavelength IF=20mA CIE127-2007* [Max.]	λ dom [1]	640*	nm
Spectral bandwidth at 50%FREL MAX IF=20mA [Typ.]	Δλ	28	nm
Forward Voltage IF=20mA [Min.]	VF [2]	-	V
Forward Voltage IF=20mA [Typ.]		1.95	
Forward Voltage IF=20mA [Max.]		2.5	
Reverse Current (VR = 5V) [Max.]	IR	10	uA
Temperature coefficient of λpeak IF=20mA, -10°C ≤ T ≤ 100°C [Typ.]	TCλpeak	0.14	nm/°C
Temperature coefficient of λdom IF=20mA, -10°C ≤ T ≤ 100°C [Typ.]	TCλdom	0.05	nm/°C
Temperature coefficient of VF IF=20mA, -10°C ≤ T ≤ 100°C [Typ.]	TCv	-2.6	mV/°C

*Wavelength value is in accordance with CIE127-2007 standards.

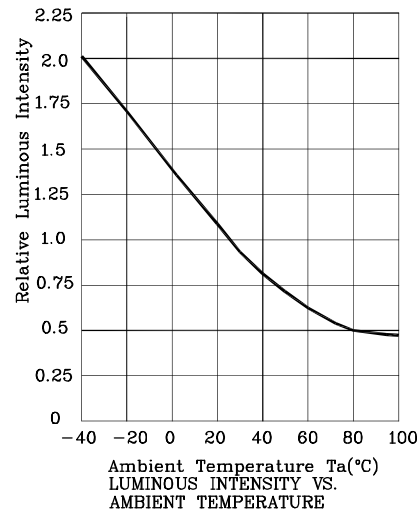
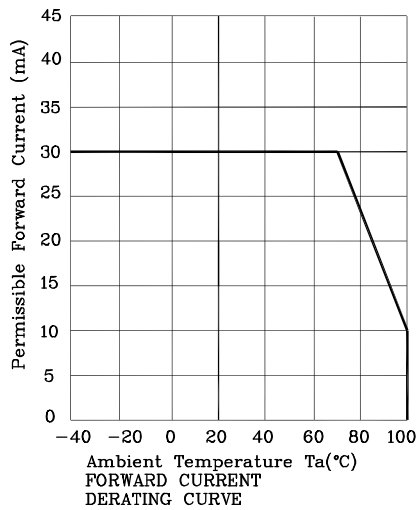
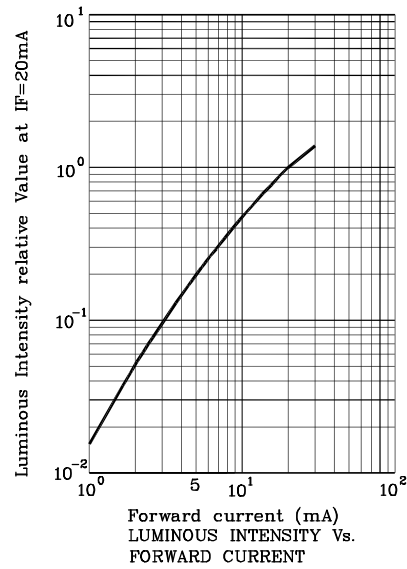
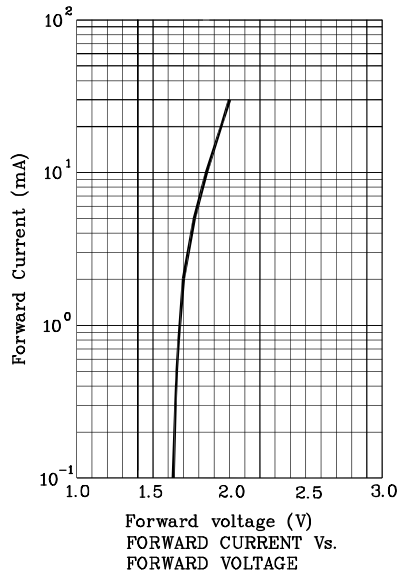
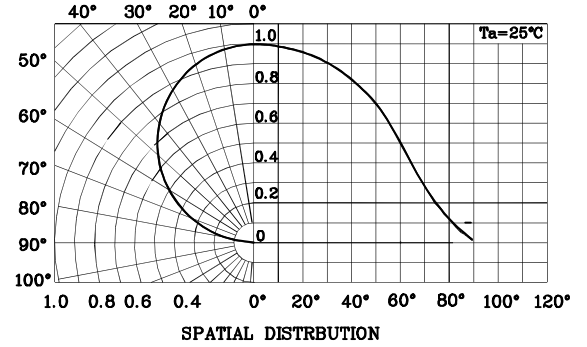
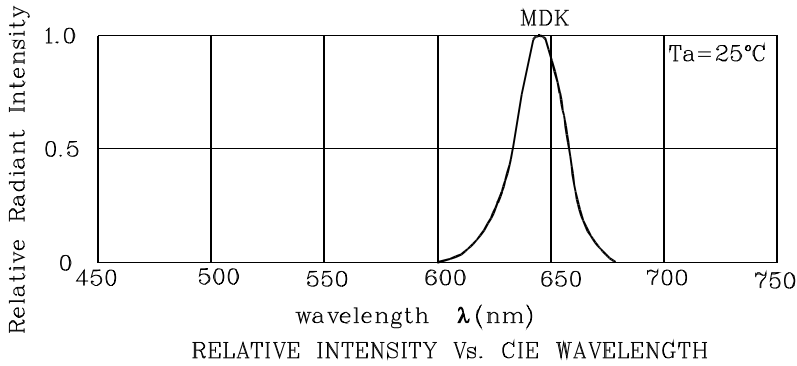

❖ LED is recommended for reflow soldering and soldering profile is shown below.

Reflow Soldering Profile For Lead-free SMT Process.

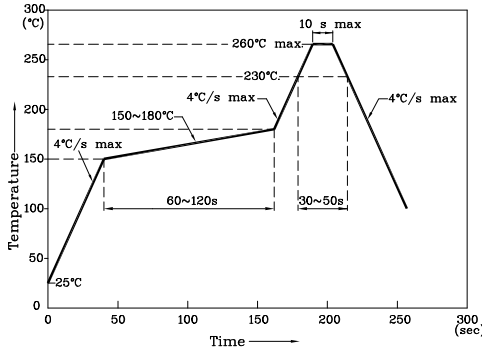

NOTES:

1. Maximum soldering temperature should not exceed 260°C.
2. Recommended reflow temperature: 145°C-260°C.
3. Do not put stress to the epoxy resin during high temperatures conditions.

❖ Reel Dimension

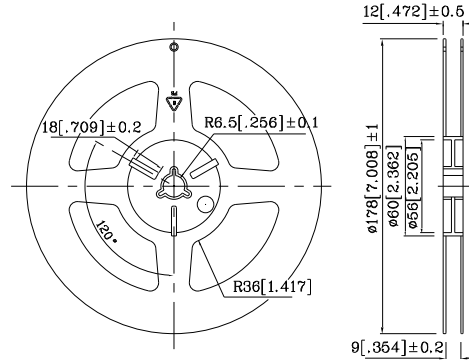

❖ Recommended Soldering Pattern
(Units : mm; Tolerance: ±0.1)

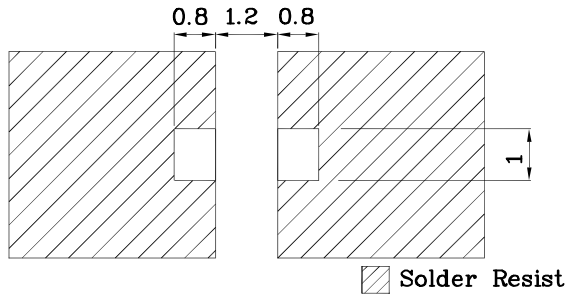

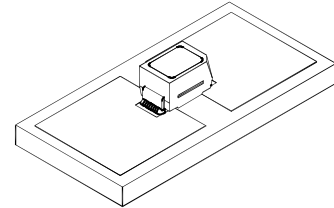

❖ The device has a single mounting surface. The device must be mounted according to the specifications.



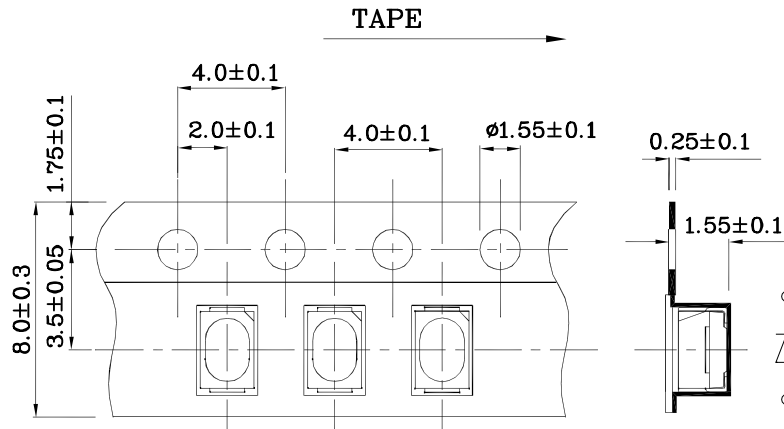

❖ Tape Specification (Units : mm)

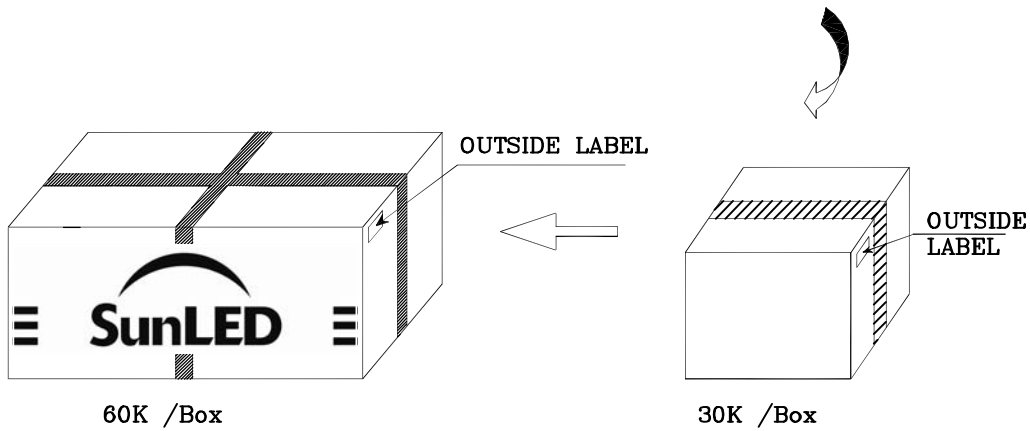
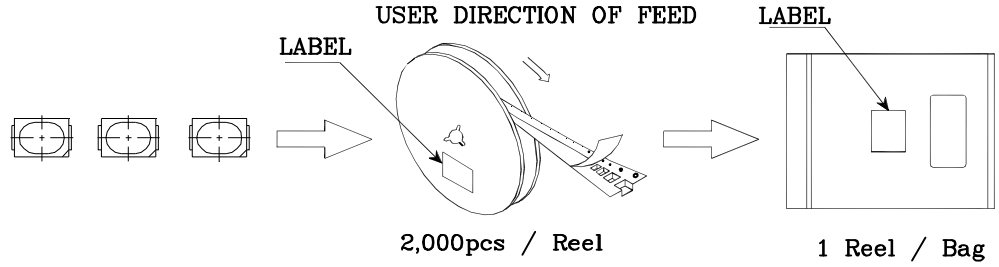

PACKING & LABEL SPECIFICATIONS

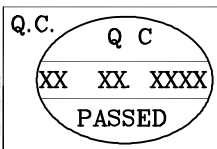
 <p>Q.C. Q C XX XX XXXX PASSED</p>
P/NO : XZxxx80x
QTY : 2,000 pcs CODE: XXX
S/N : XX
LOT NO:  XXXXXXXXXXXXXXXXXXXXXXXXXXXX
RoHS Compliant

TERMS OF USE

1. Data presented in this document reflect statistical figures and should be treated as technical reference only.
2. Contents within this document are subject to improvement and enhancement changes without notice.
3. The product(s) in this document are designed to be operated within the electrical and environmental specifications indicated on the datasheet. User accepts full risk and responsibility when operating the product(s) beyond their intended specifications.
4. The product(s) described in this document are intended for electronic applications in which a person's life is not reliant upon the LED. Please consult with a SunLED representative for special applications where the LED may have a direct impact on a person's life.
5. The contents within this document may not be altered without prior consent by SunLED.
6. Additional technical notes are available at <http://www.SunLEDusa.com/TechnicalNotes.asp>

Reliability Test Items And Conditions

The reliability of products shall be satisfied with items listed below

Lot Tolerance Percent Defective (LTPD) : 10%

No.	Test Item	Standards	Test Condition	Test Times / Cycles	Number of Damaged
1	Continuous operating test	-	Ta =25°C ,IF = maximum rated current*	1,000 h	0 / 22
2	High Temp. operating test	EIAJ ED-4701/100 (101)	Ta = 100°C IF = derated current at 100°C	1,000 h	0 / 22
3	Low Temp. operating test	-	Ta = -40°C, IF = maximum rated current*	1,000 h	0 / 22
4	High temp. storage test	EIAJ ED-4701/100 (201)	Ta = maximum rated storage temperature	1,000 h	0 / 22
5	Low temp. storage test	EIAJ ED-4701/100 (202)	Ta = -40°C	1,000 h	0 / 22
6	High temp. & humidity storage test	-	Ta = 60°C, RH = 90%	500 h	0 / 22
7	High temp. & humidity operating test	-	Ta = 60°C, RH = 90% IF = derated current at 60°C	500 h	0 / 22
8	Soldering reliability test	EIAJ ED-4701/100 (301)	Moisture soak : 30°C,70% RH, 72h Preheat : 150~180°C(120s max.) Soldering temp : 260°C(10s)	2 times	0 / 18
9	Thermal shock operating test	-	Ta = -40°C(15min) ~ 100°C(15min) IF = derated current at 100°C	1,000 cycles	0 / 22
10	Thermal shock test	-	Ta = -40°C(15min) ~ 100°C(15min)	1,000 cycles	0 / 22
11	Electric Static Discharge (ESD)	EIAJ ED-4701/100 (304)	C = 100pF , R2 = 1.5KΩ V = 3000V	Once each Polarity	0 / 22
12	Vibration test	-	a = 196m/s ² , f = 100~2KHz , t = 48min for all xyz axes	4 times	0 / 22

* : Refer to forward current vs. derating curve diagram

Failure Criteria

Items	Symbols	Conditions	Failure Criteria
luminous Intensity	Iv	IF = 20mA	Testing Min. Value <Spec.Min.Value x 0.5
Forward Voltage	VF	IF = 20mA	Testing Max. Value ≥Spec.Max.Value x 1.2
Reverse Current	IR	VR = Maximum Rated Reverse Voltage	Testing Max. Value ≥Spec.Max.Value x 2.5
High temp. storage test	-	-	Occurrence of notable decoloration, deformation and cracking