

## High Speed Two-Channel Digital Isolators

### Functional Diagrams

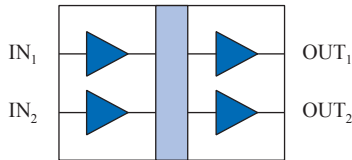

**IL711**

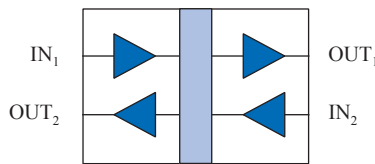

**IL712**

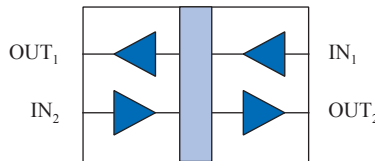

**IL721**

### Features

- High Speed: 150 Mbps typical (S-Series)
- 3 V to 5 V power supplies
- High Temperature:  $-40^{\circ}\text{C}$  to  $+125^{\circ}\text{C}$  (T-Series)
- 1.5 mA/channel typical quiescent current
- 300 ps typical pulse width distortion (S-Series)
- 100 ps typical pulse jitter
- 2 ns channel-to-channel skew
- 10 ns typical propagation delay
- Low EMC footprint
- 30 kV/ $\mu\text{s}$  typical common mode transient immunity
- 44000 year barrier life
- UL 1577 recognized; IEC 61010-1 approved; VDE 0884 pending
- MSOP, SOIC, PDIP, and True 8 mm creepage packages

### Applications

- Board-to-board communication
- CANbus
- Peripheral interfaces
- Logic level shifting
- Equipment covered under 61010-1 Edition 3
- 5 kV<sub>RMS</sub> rated IEC 60601-1 medical applications

### Description

NVE's IL700 family of high-speed digital isolators are CMOS devices manufactured with NVE's patented\* IsoLoop<sup>®</sup> spintronic Giant Magnetoresistive (GMR) technology. The IL711S and IL712S are the world's fastest two-channel isolators, with a 150 Mbps typical data rate for both channels.

A unique ceramic/polymer composite barrier provides excellent isolation and virtually unlimited barrier life.

The symmetric magnetic coupling barrier provides a typical propagation delay of only 10 ns and a pulse width distortion as low as 300 ps (0.3 ns), achieving the best specifications of any isolator. Typical transient immunity of 30 kV/ $\mu\text{s}$  is unsurpassed.

The IL711 has two transmit channels; the IL712 and IL721 have one transmit and one receive channel. The IL712 and IL721 operate full duplex, making them ideal for many fieldbus applications, including PROFIBUS, DeviceNet, and CAN. The IL721 has channels reversed to better suit certain board layouts.

Standard and S-Grade parts are specified over a temperature range of  $-40^{\circ}\text{C}$  to  $+100^{\circ}\text{C}$ ; T-Grade parts have a maximum operating temperature of  $+125^{\circ}\text{C}$ .

The IL711 and IL712 are available in 8-pin MSOP, SOIC, and PDIP packages. The IL711 and IL721 are also available in NVE's unique JEDEC-compliant 16 pin package with True 8 mm creepage under IEC 60601.

## Absolute Maximum Ratings

Parameters	Symbol	Min.	Typ.	Max.	Units	Test Conditions
Storage Temperature	$T_S$	-55		150	°C	
Ambient Operating Temperature <sup>(1)</sup> IL711T/IL712T/IL721T	$T_A$	-40		100 125	°C	
Supply Voltage	$V_{DD1}, V_{DD2}$	-0.5		7	V	
Input Voltage	$V_I$	-0.5		$V_{DD} + 0.5$	V	
Output Voltage	$V_O$	-0.5		$V_{DD} + 0.5$	V	
Output Current Drive	$I_O$			10	mA	
Lead Solder Temperature				260	°C	10 sec.
ESD			2		kV	HBM

## Recommended Operating Conditions

Parameters	Symbol	Min.	Typ.	Max.	Units	Test Conditions
Ambient Operating Temperature IL711/IL712 and IL711S/IL712S IL711T/IL712T/IL721T	$T_A$	-40 -40		100 125	°C °C	
Supply Voltage	$V_{DD1}, V_{DD2}$	3.0		5.5	V	
Logic High Input Voltage	$V_{IH}$	2.4		$V_{DD}$	V	
Logic Low Input Voltage	$V_{IL}$	0		0.8	V	
Input Signal Rise and Fall Times	$t_{IR}, t_{IF}$			1	µs	

## Insulation Specifications

Parameters	Symbol	Min.	Typ.	Max.	Units	Test Conditions
Creepage Distance (external)						
MSOP8		3.01			mm	
SOIC8		4.03			mm	
PDIP8		7.04			mm	
True 8 <sup>TM</sup> SOIC16		8.03	8.3		mm	per IEC 60601
Total Barrier Thickness (internal)		0.012	0.013		mm	
Leakage Current <sup>(5)</sup>			0.2		µA	240 V <sub>RMS</sub> , 60 Hz
Barrier Impedance <sup>(5)</sup>			$>10^{14}  3$		Ω    pF	
Barrier Life			44000		Years at 100°C	60% confidence level activation energy

## Package Characteristics

Parameters	Symbol	Min.	Typ.	Max.	Units	Test Conditions
Capacitance (Input-Output) <sup>(5)</sup>	$C_{I-O}$		2		pF	f = 1 MHz
Thermal Resistance						
MSOP8	$\theta_{JC}$		168		°C/W	Thermocouple at center underside of package
SOIC8			144			
PDIP8			54			
True 8 SOIC16			28			
Package Power Dissipation	$P_{PD}$			150	mW	f = 1 MHz, $V_{DD} = 5$ V

## Safety and Approvals

**IEC 61010-1** (TUV Certificate Numbers N1502812; N1502812-101)

### Classification as Reinforced Insulation:

Model	Package	Pollution Degree	Material Group	Max. Working Voltage
IL711-1; IL712-1	MSOP	II	III	150 V <sub>RMS</sub>
IL711-2; IL712-2	PDIP	II	III	300 V <sub>RMS</sub>
IL711-3; IL712-3; IL721-3	SOIC	II	III	150 V <sub>RMS</sub>
IL711; IL721	True 8 mm SOIC	II	III	600 V <sub>RMS</sub>

**UL 1577** (Component Recognition Program File Number **E207481**)

Each part tested at 3000 V<sub>RMS</sub> (4240 V<sub>PK</sub>) for 1 second; each lot sample tested at 2500 V<sub>RMS</sub> (3530 V<sub>PK</sub>) for 1 minute

**VDE 0884** (Pending)

600 V<sub>RMS</sub> Working Voltage; 8 mm creepage

## Soldering Profile

Per JEDEC J-STD-020C, MSL=2

### IL711-1, -2, and -3 Pin Connections

1	V <sub>DD1</sub>	Supply voltage
2	IN <sub>1</sub>	Data in, channel 1
3	IN <sub>2</sub>	Data in, channel 2
4	GND <sub>1</sub>	Ground return for V <sub>DD1</sub>
5	GND <sub>2</sub>	Ground return for V <sub>DD2</sub>
6	OUT <sub>2</sub>	Data out, channel 2
7	OUT <sub>1</sub>	Data out, channel 1
8	V <sub>DD2</sub>	Supply voltage

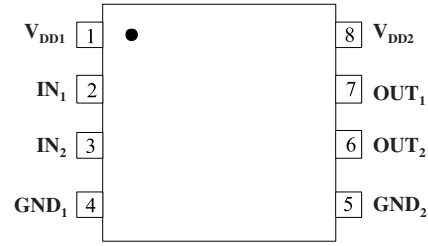

**IL711-1, -2, and -3**

### IL711 Pin Connections

1	GND <sub>1</sub>	Ground return for V <sub>DD1</sub>
2	GND <sub>1</sub>	(pins 1, 2, 7, and 8 internally connected)
3	V <sub>DD1</sub>	Supply voltage
4	IN <sub>1</sub>	Data in, channel 1
5	IN <sub>2</sub>	Data in, channel 2
6	NC	No connection
7	GND <sub>1</sub>	Ground return for V <sub>DD1</sub>
8	GND <sub>1</sub>	(pins 1, 2, 7, and 8 internally connected)
9	GND <sub>2</sub>	Ground return for V <sub>DD2</sub>
10	GND <sub>2</sub>	(pins 9, 10, 15, and 16 internally connected)
11	NC	No connection
12	OUT <sub>2</sub>	Data out, channel 2
13	OUT <sub>1</sub>	Data out, channel 1
14	V <sub>DD2</sub>	Supply voltage
15	GND <sub>2</sub>	Ground return for V <sub>DD2</sub>
16	GND <sub>2</sub>	(pins 9, 10, 15, and 16 internally connected)

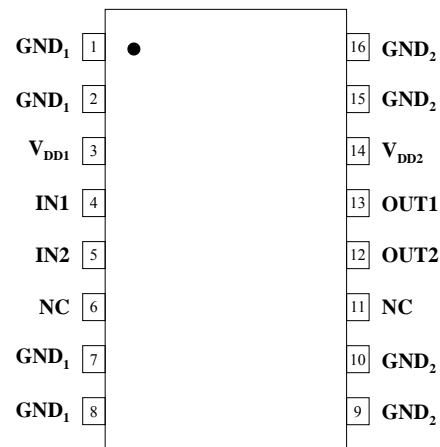

**IL711**

### IL712-1, -2, and -3 Pin Connections

1	V <sub>DD1</sub>	Supply voltage
2	IN <sub>1</sub>	Data in, channel 1
3	OUT <sub>2</sub>	Data out, channel 2
4	GND <sub>1</sub>	Ground return for V <sub>DD1</sub>
5	GND <sub>2</sub>	Ground return for V <sub>DD2</sub>
6	IN <sub>2</sub>	Data in, channel 2
7	OUT <sub>1</sub>	Data out, channel 1
8	V <sub>DD2</sub>	Supply voltage

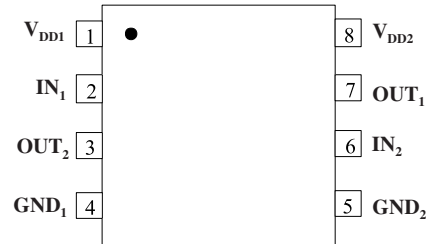

**IL712-1, -2, and -3**

### IL721-3 Pin Connections

1	V <sub>DD1</sub>	Supply voltage
2	OUT <sub>1</sub>	Data out, channel 1
3	IN <sub>2</sub>	Data in, channel 2
4	GND <sub>1</sub>	Ground return for V <sub>DD1</sub>
5	GND <sub>2</sub>	Ground return for V <sub>DD2</sub>
6	OUT <sub>2</sub>	Data out, channel 2
7	IN <sub>1</sub>	Data in, channel 1
8	V <sub>DD2</sub>	Supply voltage

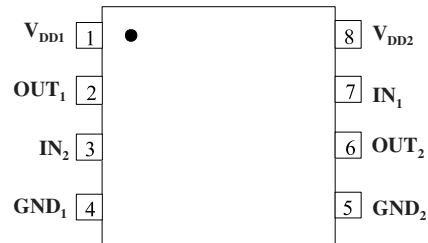

**IL721-3**

**IL721 Pin Connections**

1		Ground return for $V_{DD1}$
2	$GND_1$	(pins 1, 2, 7, and 8 internally connected)
3	$V_{DD1}$	Supply voltage
4	$OUT_1$	Data out, channel 1
5	$IN_2$	Data in, channel 2
6	NC	No connection
7		Ground return for $V_{DD1}$
8	$GND_1$	(pins 1, 2, 7, and 8 internally connected)
9		Ground return for $V_{DD2}$
10	$GND_2$	(pins 9, 10, 15, and 16 internally connected)
11	NC	No connection
12	$OUT_2$	Data out, channel 2
13	$IN_1$	Data in, channel 1
14	$V_{DD2}$	Supply voltage
15		Ground return for $V_{DD2}$
16	$GND_2$	(pins 9, 10, 15, and 16 internally connected)

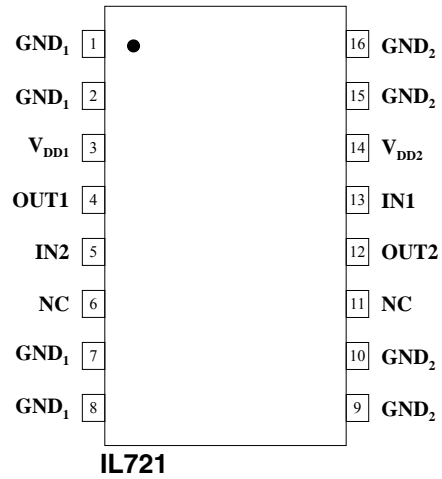

3.3 Volt Electrical Specifications (T <sub>min</sub> to T <sub>max</sub> unless otherwise stated)						
Parameters	Symbol	Min.	Typ.	Max.	Units	Test Conditions
Input Quiescent Supply Current						
IL711	I <sub>DD1</sub>		8	10	μA	
IL712/IL721			1.5	2	mA	
Output Quiescent Supply Current						
IL711	I <sub>DD2</sub>		3	4	mA	
IL712/IL721			1.5	2	mA	
Logic Input Current	I <sub>I</sub>	-10		10	μA	
Logic High Output Voltage	V <sub>OH</sub>	V <sub>DD</sub> - 0.1	V <sub>DD</sub>		V	I <sub>O</sub> = -20 μA, V <sub>I</sub> = V <sub>IH</sub>
		0.8 x V <sub>DD</sub>	0.9 x V <sub>DD</sub>			I <sub>O</sub> = -4 mA, V <sub>I</sub> = V <sub>IH</sub>
Logic Low Output Voltage	V <sub>OL</sub>		0	0.1	V	I <sub>O</sub> = 20 μA, V <sub>I</sub> = V <sub>IL</sub>
			0.5	0.8		I <sub>O</sub> = 4 mA, V <sub>I</sub> = V <sub>IL</sub>

Switching Specifications (V <sub>DD</sub> = 3.3 V)						
Maximum Data Rate						
IL711/IL712/IL721		100	110		Mbps	C <sub>L</sub> = 15 pF
IL711S/IL712S		130	140		Mbps	C <sub>L</sub> = 15 pF
IL711T/IL712T/IL721T		100	110		Mbps	C <sub>L</sub> = 15 pF
Pulse Width <sup>(7)</sup>	PW	10	7.5		ns	50% Points, V <sub>O</sub>
Propagation Delay Input to Output (High to Low)	t <sub>PHL</sub>		12	18	ns	C <sub>L</sub> = 15 pF
Propagation Delay Input to Output (Low to High)	t <sub>PLH</sub>		12	18	ns	C <sub>L</sub> = 15 pF
Pulse Width Distortion <sup>(2)</sup>	PWD	IL711/IL712/IL721 IL711S/IL712S IL711T/IL712T/IL721T	2	3	ns	C <sub>L</sub> = 15 pF
			2	3	ns	C <sub>L</sub> = 15 pF
			1	3	ns	C <sub>L</sub> = 15 pF
Propagation Delay Skew <sup>(3)</sup>	t <sub>PSK</sub>		4	6	ns	C <sub>L</sub> = 15 pF
Output Rise Time (10%–90%)	t <sub>R</sub>		2	4	ns	C <sub>L</sub> = 15 pF
Output Fall Time (10%–90%)	t <sub>F</sub>		2	4	ns	C <sub>L</sub> = 15 pF
Common Mode Transient Immunity (Output Logic High or Logic Low) <sup>(4)</sup>	CM <sub>H</sub>  ,  CM <sub>L</sub>	20	30		kV/μs	V <sub>CM</sub> = 300 V
Channel-to-Channel Skew	t <sub>CSK</sub>		2	3	ns	C <sub>L</sub> = 15 pF
Dynamic Power Consumption <sup>(6)</sup>			140	240	μA/MHz	per channel

Magnetic Field Immunity <sup>(8)</sup> (V <sub>DD2</sub> = 3V, 3V < V <sub>DD1</sub> < 5.5V)						
Power Frequency Magnetic Immunity	H <sub>PF</sub>	1000	1500		A/m	50Hz/60Hz
Cross-axis Immunity Multiplier <sup>(9)</sup>	K <sub>X</sub>		2.5			

## Timing Diagram

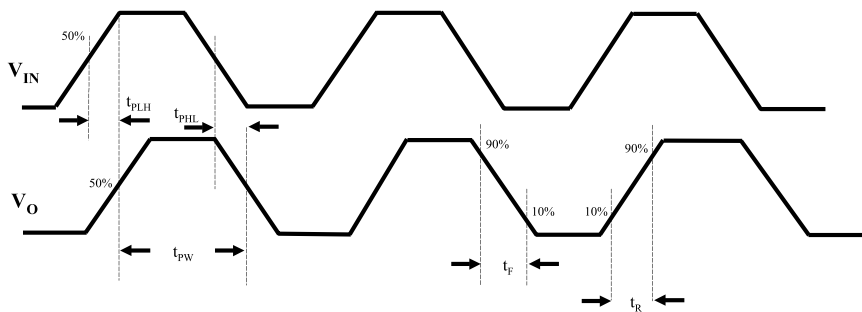

## Legend

t <sub>PLH</sub>	Propagation Delay, Low to High
t <sub>PHL</sub>	Propagation Delay, High to Low
t <sub>PW</sub>	Minimum Pulse Width
t <sub>R</sub>	Rise Time
t <sub>F</sub>	Fall Time

5 Volt Electrical Specifications (T <sub>min</sub> to T <sub>max</sub> unless otherwise stated)						
Parameters	Symbol	Min.	Typ.	Max.	Units	Test Conditions
Input Quiescent Supply Current						
IL711	I <sub>DD1</sub>		10	15	μA	
IL712/IL721			2	3	mA	
Output Quiescent Supply Current						
IL711	I <sub>DD2</sub>		4	6	mA	
IL712/IL721				2	3	mA
Logic Input Current	I <sub>I</sub>	-10		10	μA	
Logic High Output Voltage	V <sub>OH</sub>	V <sub>DD</sub> - 0.1	V <sub>DD</sub>		V	I <sub>O</sub> = -20 μA, V <sub>I</sub> = V <sub>IH</sub>
		0.8 x V <sub>DD</sub>	0.9 x V <sub>DD</sub>			I <sub>O</sub> = -4 mA, V <sub>I</sub> = V <sub>IH</sub>
Logic Low Output Voltage	V <sub>OL</sub>		0	0.1	V	I <sub>O</sub> = 20 μA, V <sub>I</sub> = V <sub>IL</sub>
				0.5		0.8

Switching Specifications (V <sub>DD</sub> = 5 V)							
Maximum Data Rate							
IL711/IL712/IL721		100	110		Mbps	C <sub>L</sub> = 15 pF	
IL711S/IL712S		130	150		Mbps	C <sub>L</sub> = 15 pF	
IL711T/IL712T/IL721T		100	110		Mbps	C <sub>L</sub> = 15 pF	
Pulse Width <sup>(7)</sup>	PW	10	7.5		ns	50% Points, V <sub>O</sub>	
Propagation Delay Input to Output (High to Low)	t <sub>PHL</sub>		10	15	ns	C <sub>L</sub> = 15 pF	
Propagation Delay Input to Output (Low to High)	t <sub>PLH</sub>		10	15	ns	C <sub>L</sub> = 15 pF	
Pulse Width Distortion <sup>(2)</sup>	PWD						
IL711/IL712/IL721				2	3	ns	C <sub>L</sub> = 15 pF
IL711S/IL712S					2	3	ns
IL711T/IL712T/IL721T				0.3	3	ns	C <sub>L</sub> = 15 pF
Pulse Jitter <sup>(10)</sup>	t <sub>J</sub>		100		ps	C <sub>L</sub> = 15 pF	
Propagation Delay Skew <sup>(3)</sup>	t <sub>PSK</sub>		4	6	ns	C <sub>L</sub> = 15 pF	
Output Rise Time (10%–90%)	t <sub>R</sub>		1	3	ns	C <sub>L</sub> = 15 pF	
Output Fall Time (10%–90%)	t <sub>F</sub>		1	3	ns	C <sub>L</sub> = 15 pF	
Common Mode Transient Immunity (Output Logic High or Logic Low) <sup>(4)</sup>	CM <sub>H</sub>  , CM <sub>L</sub>	20	30		kV/μs	V <sub>cm</sub> = 300 V	
Channel to Channel Skew	t <sub>CSK</sub>		2	3	ns	C <sub>L</sub> = 15 pF	
Dynamic Power Consumption <sup>(6)</sup>			200	340	μA/MHz	per channel	

Magnetic Field Immunity <sup>(8)</sup> (V <sub>DD2</sub> = 5V, 3V < V <sub>DD1</sub> < 5.5V)						
Power Frequency Magnetic Immunity	H <sub>PF</sub>	2800	3500		A/m	50Hz/60Hz
Pulse Magnetic Field Immunity	H <sub>PM</sub>	4000	4500		A/m	t <sub>p</sub> = 8μs
Damped Oscillatory Magnetic Field	H <sub>OSC</sub>	4000	4500		A/m	0.1Hz – 1MHz
Cross-axis Immunity Multiplier <sup>(9)</sup>	K <sub>X</sub>		2.5			

### Notes (apply to both 3.3 V and 5 V specifications):

1. Absolute maximum ambient operating temperature means the device will not be damaged if operated under these conditions. It does not guarantee performance.
2. PWD is defined as |t<sub>PHL</sub> - t<sub>PLH</sub>|. %PWD is equal to PWD divided by pulse width.
3. t<sub>PSK</sub> is the magnitude of the worst-case difference in t<sub>PHL</sub> and/or t<sub>PLH</sub> between devices at 25°C.
4. CM<sub>H</sub> is the maximum common mode voltage slew rate that can be sustained while maintaining V<sub>O</sub> > 0.8 V<sub>DD2</sub>. CM<sub>L</sub> is the maximum common mode input voltage that can be sustained while maintaining V<sub>O</sub> < 0.8 V. The common mode voltage slew rates apply to both rising and falling common mode voltage edges.
5. Device is considered a two terminal device: pins 1–4 shorted and pins 5–8 shorted.
6. Dynamic power consumption is calculated per channel and is supplied by the channel's input side power supply.
7. Minimum pulse width is the minimum value at which specified PWD is guaranteed.
8. The relevant test and measurement methods are given in the Electromagnetic Compatibility section on p. 6.
9. External magnetic field immunity is improved by this factor if the field direction is “end-to-end” rather than to “pin-to-pin” (see diagram on p. 6).
10. 64k-bit pseudo-random binary signal (PRBS) NRZ bit pattern with no more than five consecutive 1s or 0s; 800 ps transition time.

## Application Information

### Electrostatic Discharge Sensitivity

This product has been tested for electrostatic sensitivity to the limits stated in the specifications. However, NVE recommends that all integrated circuits be handled with appropriate care to avoid damage. Damage caused by inappropriate handling or storage could range from performance degradation to complete failure.

### Electromagnetic Compatibility

IsoLoop Isolators have the lowest EMC footprint of any isolation technology. IsoLoop Isolators' Wheatstone bridge configuration and differential magnetic field signaling ensure excellent EMC performance against all relevant standards.

These isolators are fully compliant with generic EMC standards EN50081, EN50082-1 and the umbrella line-voltage standard for Information Technology Equipment (ITE) EN61000. NVE has completed compliance tests in the categories below:

EN50081-1

Residential, Commercial & Light Industrial  
Methods EN55022, EN55014

EN50082-2: Industrial Environment

Methods EN61000-4-2 (ESD), EN61000-4-3 (Electromagnetic Field Immunity), EN61000-4-4 (Electrical Transient Immunity), EN61000-4-6 (RFI Immunity), EN61000-4-8 (Power Frequency Magnetic Field Immunity), EN61000-4-9 (Pulsed Magnetic Field), EN61000-4-10 (Damped Oscillatory Magnetic Field)

ENV50204

Radiated Field from Digital Telephones (Immunity Test)

Immunity to external magnetic fields is even higher if the field direction is "end-to-end" rather than to "pin-to-pin" as shown in the diagram below:

Cross-axis Field Direction

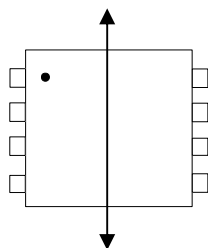

### Dynamic Power Consumption

IsoLoop Isolators achieve their low power consumption from the way they transmit data across the isolation barrier. By detecting the edge transitions of the input logic signal and converting these to narrow current pulses, a magnetic field is created around the GMR Wheatstone bridge. Depending on the direction of the magnetic field, the bridge causes the output comparator to switch following the input logic signal. Since the current pulses are narrow, about 2.5 ns, the power consumption is independent of mark-to-space ratio and solely dependent on frequency. This has obvious advantages over optocouplers, which have power consumption heavily dependent on mark-to-space ratio.

### Power Supply Decoupling

Both power supplies to these devices should be decoupled with low-ESR 47 nF ceramic capacitors. Ground planes for both GND<sub>1</sub> and GND<sub>2</sub> are highly recommended for data rates above 10 Mbps. Capacitors must be located as close as possible to the V<sub>DD</sub> pins.

### Maintaining Creepage

Creepage distances are often critical in isolated circuits. In addition to meeting JEDEC standards, NVE isolator packages have unique creepage specifications. Standard pad libraries often extend under the package, compromising creepage and clearance. Similarly, ground planes, if used, should be spaced to avoid compromising clearance. Package drawings and recommended pad layouts are included in this datasheet.

### Signal Status on Start-up and Shut Down

To minimize power dissipation, input signals are differentiated and then latched on the output side of the isolation barrier to reconstruct the signal. This could result in an ambiguous output state depending on power up, shutdown and power loss sequencing. Unless the circuit connected to the isolator performs its own power-on reset (POR), a start-up initialization circuit should be considered. Initialization consists of toggling the input either high then low, or low then high.

In CAN applications, the IL712 or IL721 should be used with CAN transceivers with Dominant Timeout functions for seamless POR. Most CAN transceivers have Dominant Timeout options. Examples include NXP's TJA 1050 and TJA 1040 transceivers.

### Data Transmission Rates

The reliability of a transmission system is directly related to the accuracy and quality of the transmitted digital information. For a digital system, those parameters which determine the limits of the data transmission are pulse width distortion and propagation delay skew.

Propagation delay is the time taken for the signal to travel through the device. This is usually different when sending a low-to-high than when sending a high-to-low signal. This difference, or error, is called pulse width distortion (PWD) and is usually in nanoseconds. It may also be expressed as a percentage:

$$PWD\% = \frac{\text{Maximum Pulse Width Distortion (ns)}}{\text{Signal Pulse Width (ns)}} \times 100\%$$

For example, with data rates of 12.5 Mbps:

$$PWD\% = \frac{3 \text{ ns}}{80 \text{ ns}} \times 100\% = 3.75\%$$

This figure is almost **three times** better than any available optocoupler with the same temperature range, and **two times** better than any optocoupler regardless of published temperature range. IsoLoop isolators exceed the 10% maximum PWD recommended by PROFIBUS, and will run to nearly 35 Mb within the 10% limit.

Propagation delay skew is the signal propagation difference between two or more channels. This becomes significant in clocked systems because it is undesirable for the clock pulse to arrive before the data has settled. Propagation delay skew is especially critical in high data rate parallel systems for establishing and maintaining accuracy and repeatability. Worst-case channel-to-channel skew in an IL700 Isolator is just 3 ns—**ten times** better than any optocoupler. IL700 Isolators have a maximum propagation delay skew of 6 ns—**five times** better than any optocoupler.

**Illustrative Applications**

NVE offers a unique line of single-chip isolated RS-485, PROFIBUS, and CAN transceivers, but as illustrated in the circuits below, IL700-Series Isolators can also be used as part of multi-chip designs with non-isolated transceivers:

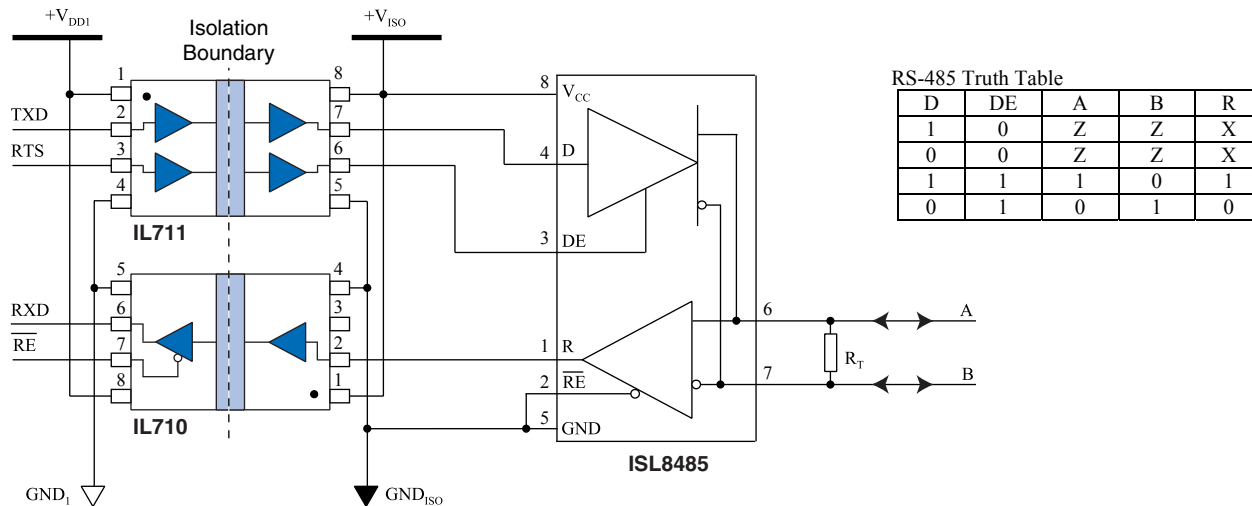

**Figure 1. Isolated PROFIBUS / RS-485 circuit.**

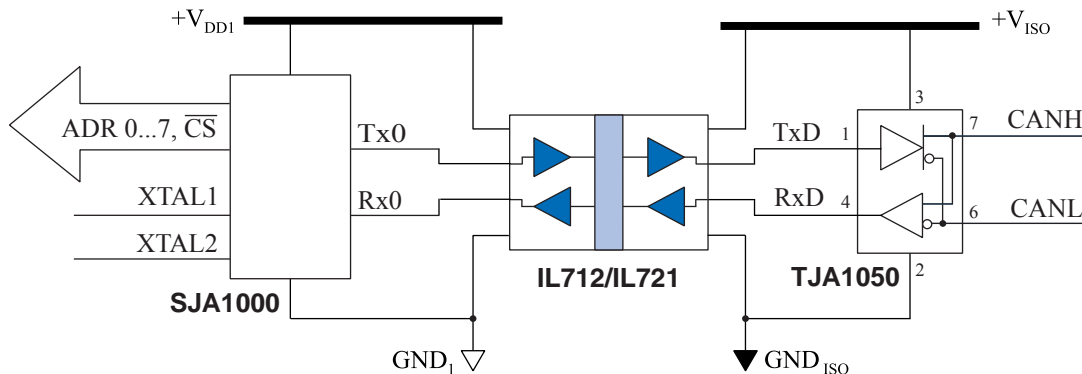

**Figure 2. Isolated CAN circuit.**

In today's CAN networks, node-to-node isolation is increasingly recommended by designers to reduce EMI susceptibility, especially in high-speed applications and in hybrid and electrical vehicle networks, where the 12 V battery has been replaced with one of several hundred volts. Operator and equipment safety becomes critical when a high voltage source, such as the battery, needs to be connected to diagnosis systems during routine maintenance procedures. In the application shown above, the microcontroller is isolated from the CAN transceiver by an IL712 or IL721, allowing higher speed and more reliable bus operation by eliminating ground loops and reducing susceptibility to noise and EMI events. The best-in-class 10 ns typical IL712/IL721 propagation delay minimizes CAN loop delay and maximizes data rate over any given bus length. The simple circuit works with any CAN transceiver with a TxD dominant timeout, which includes all of the current-generation transceivers.



**Package Drawings**

**8-pin MSOP (-1 suffix)**

Dimensions in inches (mm); scale = approx. 5X

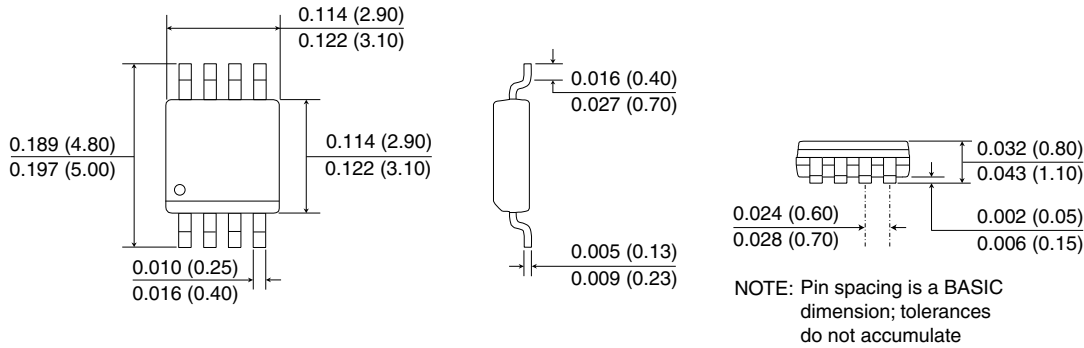

**8-pin SOIC Package (-3 suffix)**

Dimensions in inches (mm); scale = approx. 5X

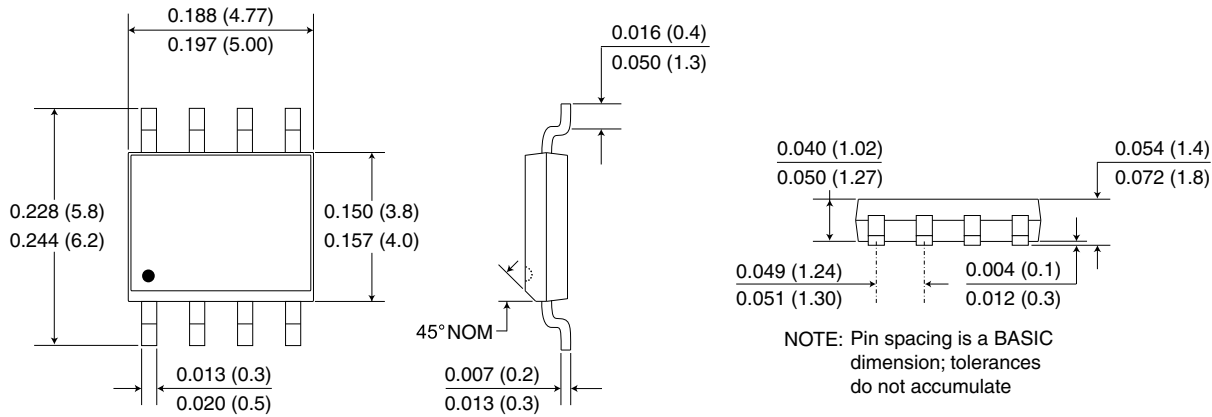

**8-pin PDIP (-2 suffix)**

Dimensions in inches (mm); scale = approx. 2.5X

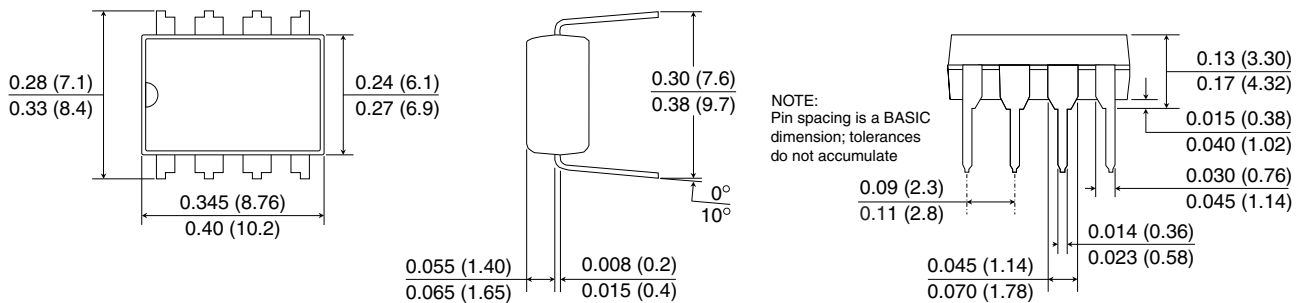

**True 8™ (8 mm creepage) 16-pin SOIC Package (no suffix)**

Dimensions in inches (mm); scale = approx. 5X

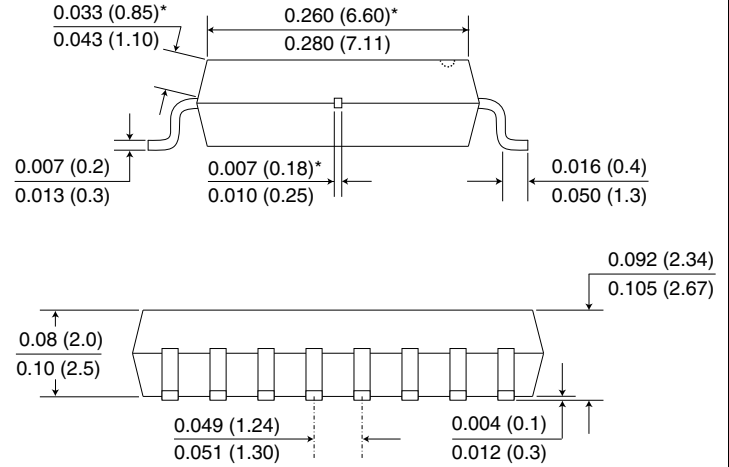
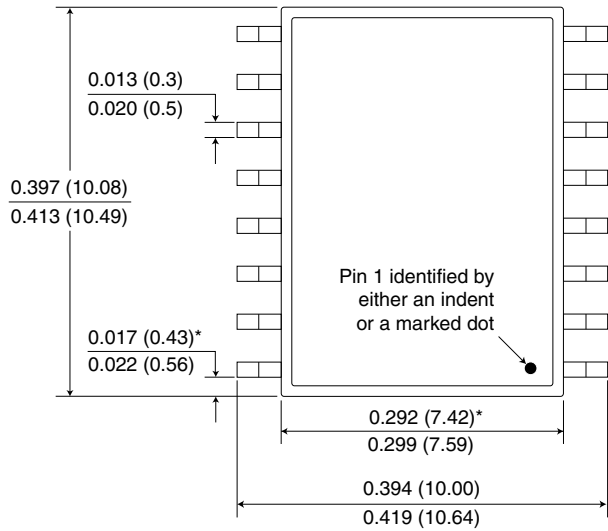

NOTE: Pin spacing is a BASIC dimension; tolerances do not accumulate

\*Specified for True 8™ package to guarantee 8 mm creepage per IEC 60601.

**Recommended Pad Layouts**

**8-pin MSOP Pad Layout**

Dimensions in inches (mm); scale = approx. 5X

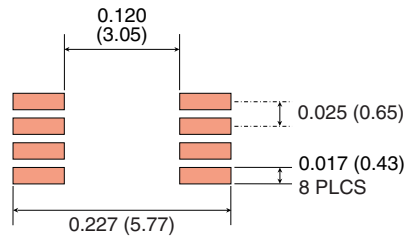

**8-pin SOIC Pad Layout**

Dimensions in inches (mm); scale = approx. 5X

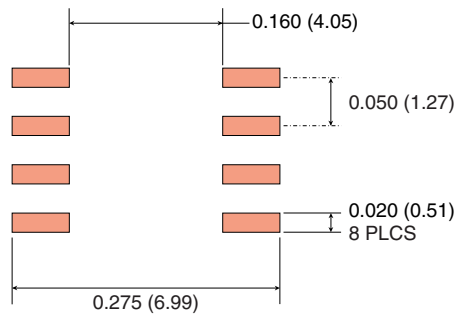

**True 8™ 16-pin SOIC Pad Layout**

Dimensions in inches (mm); scale = approx. 5X

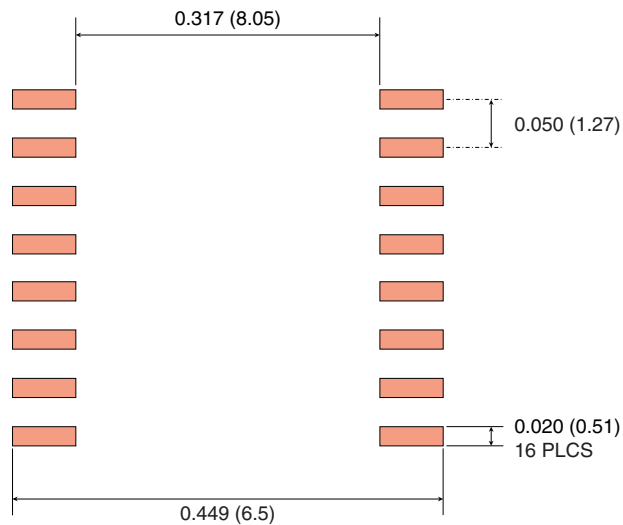

**Ordering Information and Valid Part Numbers**

**IL 711 T - 3 E TR13**

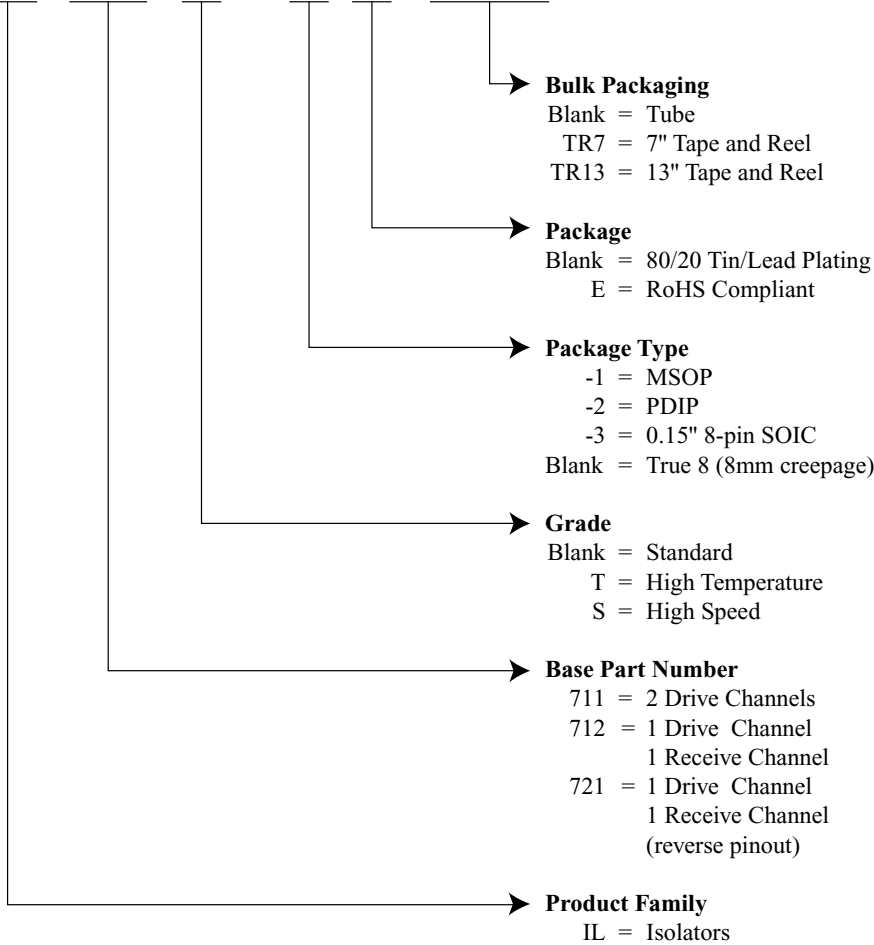

**Valid Part Numbers**

IL711E	IL712-1	IL721E
IL711TE	IL712-1E	IL721TE
	IL712S-1	
IL711-1	IL712S-1E	IL721-3
IL711-1E	IL712T-1	IL721-3E
IL711S-1	IL712T-1E	IL721T-3
IL711S-1E		IL721T-3E
IL711T-1	IL712-2	
IL711T-1E	IL712-2E	
	IL712T-2	
IL711-2	IL712T-2E	
IL711-2E		
IL711T-2	IL712-3	
IL711T-2E	IL712S-3	
	IL712T-3	
IL711-3	IL712-3E	
IL711S-3	IL712S-3E	
IL711T-3	IL712T-3E	
IL711-3E		
IL711S-3E		
IL711T-3E		

All MSOP and SOIC parts are available on tape and reel.



**ISB-DS-001-IL711/12-AB**  
**March 2013**

**Changes**

- Added wide-body package option.
- VDE0884 compliance pending.
- Added recommended solder pad layouts.

**ISB-DS-001-IL711/12-AA**

**Changes**

- Detailed isolation and barrier specifications.
- Cosmetic changes.

**ISB-DS-001-IL711/12-Z**

**Changes**

- Tightened IL711 typ. output quiescent supply spec. from 3.3 mA to 3 mA at 3.3V.

**ISB-DS-001-IL711/12-Y**

**Changes**

- Updates to terms and conditions.

**ISB-DS-001-IL711/12-X**

**Changes**

- Changed MSOP pin spacing (p. 8).

**ISB-DS-001-IL711/12-W**

**Changes**

- Changed MSOP pin spacing (p. 8).
- Clarified S-Series and T-Series speed specifications.

**ISB-DS-001-IL711/12-V**

**Changes**

- Added IL721 configuration.

**ISB-DS-001-IL711/12-U**

**Changes**

- Added CAN application diagram (p. 7).

**ISB-DS-001-IL711/12-T**

**Changes**

- Added typical jitter specification at 5V.

**ISB-DS-001-IL711/12-S**

**Changes**

- Added EMC details.

**ISB-DS-001-IL711/12-R**

**Changes**

- IEC 61010 approval for MSOP versions.

**ISB-DS-001-IL711/12-Q**

**Changes**

- Added magnetic field immunity and electromagnetic compatibility specifications.

**ISB-DS-001-IL711/12-P**

**Changes**

- Correct SOIC package drawing.

**ISB-DS-001-IL711/12-O**

**Changes**

- Note on all package drawings that pin-spacing tolerances are non-accumulating; change MSOP pin-spacing dimensions and tolerance accordingly.

**ISB-DS-001-IL711/12-N**

**Changes**

- Changed lower limit of length on PDIP package drawing.
- Tightened pin-spacing tolerance on MSOP package drawing.

**ISB-DS-001-IL711/12-M**

**Changes**

- Changed ordering information to reflect that devices are now fully RoHS compliant with no exemptions.

#### **Datasheet Limitations**

The information and data provided in datasheets shall define the specification of the product as agreed between NVE and its customer, unless NVE and customer have explicitly agreed otherwise in writing. All specifications are based on NVE test protocols. In no event however, shall an agreement be valid in which the NVE product is deemed to offer functions and qualities beyond those described in the datasheet.

#### **Limited Warranty and Liability**

Information in this document is believed to be accurate and reliable. However, NVE does not give any representations or warranties, expressed or implied, as to the accuracy or completeness of such information and shall have no liability for the consequences of use of such information.

In no event shall NVE be liable for any indirect, incidental, punitive, special or consequential damages (including, without limitation, lost profits, lost savings, business interruption, costs related to the removal or replacement of any products or rework charges) whether or not such damages are based on tort (including negligence), warranty, breach of contract or any other legal theory.

#### **Right to Make Changes**

NVE reserves the right to make changes to information published in this document including, without limitation, specifications and product descriptions at any time and without notice. This document supersedes and replaces all information supplied prior to its publication.

#### **Use in Life-Critical or Safety-Critical Applications**

Unless NVE and a customer explicitly agree otherwise in writing, NVE products are not designed, authorized or warranted to be suitable for use in life support, life-critical or safety-critical devices or equipment. NVE accepts no liability for inclusion or use of NVE products in such applications and such inclusion or use is at the customer's own risk. Should the customer use NVE products for such application whether authorized by NVE or not, the customer shall indemnify and hold NVE harmless against all claims and damages.

#### **Applications**

Applications described in this datasheet are illustrative only. NVE makes no representation or warranty that such applications will be suitable for the specified use without further testing or modification.

Customers are responsible for the design and operation of their applications and products using NVE products, and NVE accepts no liability for any assistance with applications or customer product design. It is customer's sole responsibility to determine whether the NVE product is suitable and fit for the customer's applications and products planned, as well as for the planned application and use of customer's third party customers. Customers should provide appropriate design and operating safeguards to minimize the risks associated with their applications and products.

NVE does not accept any liability related to any default, damage, costs or problem which is based on any weakness or default in the customer's applications or products, or the application or use by customer's third party customers. The customer is responsible for all necessary testing for the customer's applications and products using NVE products in order to avoid a default of the applications and the products or of the application or use by customer's third party customers. NVE accepts no liability in this respect.

#### **Limiting Values**

Stress above one or more limiting values (as defined in the Absolute Maximum Ratings System of IEC 60134) will cause permanent damage to the device. Limiting values are stress ratings only and operation of the device at these or any other conditions above those given in the recommended operating conditions of the datasheet is not warranted. Constant or repeated exposure to limiting values will permanently and irreversibly affect the quality and reliability of the device.

#### **Terms and Conditions of Sale**

In case an individual agreement is concluded only the terms and conditions of the respective agreement shall apply. NVE hereby expressly objects to applying the customer's general terms and conditions with regard to the purchase of NVE products by customer.

#### **No Offer to Sell or License**

Nothing in this document may be interpreted or construed as an offer to sell products that is open for acceptance or the grant, conveyance or implication of any license under any copyrights, patents or other industrial or intellectual property rights.

#### **Export Control**

This document as well as the items described herein may be subject to export control regulations. Export might require a prior authorization from national authorities.

#### **Automotive Qualified Products**

Unless the datasheet expressly states that a specific NVE product is automotive qualified, the product is not suitable for automotive use. It is neither qualified nor tested in accordance with automotive testing or application requirements. NVE accepts no liability for inclusion or use of non-automotive qualified products in automotive equipment or applications.

In the event that customer uses the product for design-in and use in automotive applications to automotive specifications and standards, customer (a) shall use the product without NVE's warranty of the product for such automotive applications, use and specifications, and (b) whenever customer uses the product for automotive applications beyond NVE's specifications such use shall be solely at customer's own risk, and (c) customer fully indemnifies NVE for any liability, damages or failed product claims resulting from customer design and use of the product for automotive applications beyond NVE's standard warranty and NVE's product specifications.

An ISO 9001 Certified Company

NVE Corporation  
11409 Valley View Road  
Eden Prairie, MN 55344-3617 USA  
Telephone: (952) 829-9217  
Fax: (952) 829-9189  
[www.nve.com](http://www.nve.com)  
e-mail: [iso-info@nve.com](mailto:iso-info@nve.com)

©NVE Corporation  
All rights are reserved. Reproduction in whole or in part is prohibited without the prior written consent of the copyright owner.

ISB-DS-001-IL711/12-AB

*March 2013*