

Infrared Remote Control Receiver Module EAIRMIA2

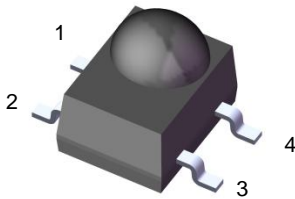

Pin Configuration

1. GND
2. GND
3. OUT
4. Vcc

Block Diagram

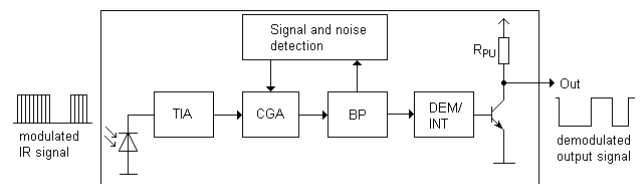

Features

- High shielding against electric field disturbance.
- Circular lens to improve the receive characteristic.
- Line-up for various center carrier frequencies.
- Low voltage and low power consumption.
- High immunity against ambient light.
- Photodiode with integrated circuit.
- TTL and CMOS compatibility.
- Top-received SMD.
- Suitable burst length ≥ 10 pulses/burst.
- This product itself will remain within RoHS compliant version.
- Pb free.
- External dimensions 5(L)*7(W)*4(H)mm.
- Compliance with EU REACH
- Compliance Halogen Free .(Br <900 ppm ,Cl <900 ppm , Br+Cl < 1500 ppm)

Descriptions

- The device is miniature SMD type infrared receiver that has been developed and designed by utilizing the latest IC technology.
- The PIN diode and preamplifier are assembled onto a lead frame and molded into an epoxy package which operates as an IR filter. The demodulated output signal can directly be decoded by a microprocessor

Applications

- Light detecting portion of remote control
- AV instruments such as Audio, TV, VCR, CD, MD, etc
- Home appliances such as Air-conditioner, Fan, etc
- Other devices using IR remote control
- CATV set top boxes
- Multi-media Equipment

Application Circuit

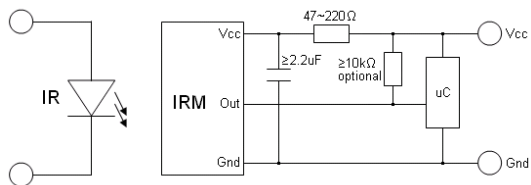

RC Filter should be connected closely between Vcc pin and GND pin.

Parts Table

Model No.	Carrier Frequency
EAIRMIA2	38 kHz

Absolute Maximum Ratings ($T_a=25^\circ\text{C}$)

Parameter	Symbol	Rating	Unit
Supply Voltage	Vs	6	V
Operating Temperature	Topr	-20 ~ +85	°C
Storage Temperature	Tstg	-40 ~ +85	°C

Electro-Optical Characteristics (Ta=25°C and Vcc=3.0V)

Parameter	Symbol	MIN.	TYP.	MAX.	Unit	Condition
Current Consumption	I _{cc}	-	-	1.2	mA	No signal input
Supply Voltage	V _s	2.7	-	-	V	
Peak Wavelength	λ _p	-	940	-	nm	
Reception Distance	L ₀	8	-	-	m	At the ray axis *1
	L ₄₅	5	-	-		
Half Angle (Horizontal)	Θ _h	-	45	-	deg	
Half Angle (Vertical)	Θ _v	-	45	-	deg	
High Level Pulse Width	T _{WH}	400	-	800	μs	At the ray axis *2
Low Level Pulse Width	T _{WL}	400	-	800	μs	
High Level Output Voltage	V _H	2.7	-	-	V	
Low Level Output Voltage	V _L	-	0.2	0.5	V	

Notes:

- *1 : The ray receiving surface at a vertex and relation to the ray axis in the range of θ= 0° and θ=45°.
- *2 : A range from 30cm to the arrival distance. Average value of 50 pulses.

The Notice of Application:

Transmission remote control signal consist of four parts: Encode Part, IR Transmitter Source, IRM device, Decode Part

1. When IRM-H6XXT code select frequency, it need to well understand the center system of encode part.
2. Strong or weak light of IR Transmitter can affect distance of transmission.
3. Minimum Burst Length Tburst (number of pulses per burst) : 10 cycles
4. It needs to ensure the translation range of decode part if it is applied to the pulse-width range.

Test Method

The specified electro-optical characteristic is satisfied under the following Conditions:

1. Measurement environment
A place without extreme light reflected
2. External light
Ordinary white fluorescent lamps (Light source temperature 2856°K, $E_e \leq 10\text{Lux}$) without high frequency modulation
3. Standard transmitter
The test transmitter is calibrated by using the circuit shown in figure 2. The radiation intensity of the transmitter is adjusted until $V_o=400\text{mVp-p}$. Both, the test transmitter and the photo diode, have a peak wavelength of 940nm. The photo diode for calibration is PD438B ($\lambda_p=940\text{nm}$, $V_r=5\text{V}$).
4. Measuring system According to the measuring system shown in Fig.-3

Fig.-1 Transmitter Wave Form

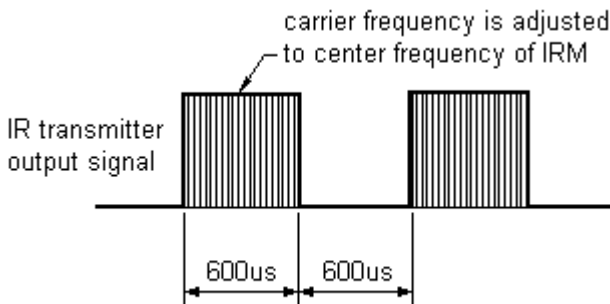

D.U.T output Pulse

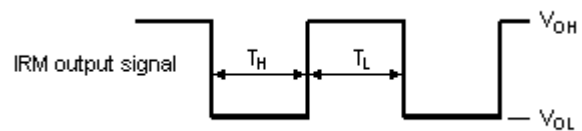

Fig.-2 Measuring Method

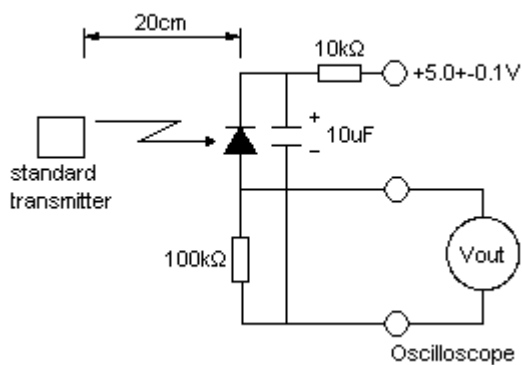
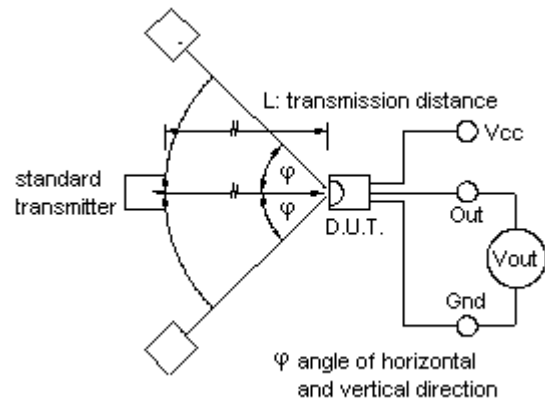

Fig.-3 Measuring System



Typical Performance Curves

Fig.-4 Relative Spectral Sensitivity vs. Wavelength

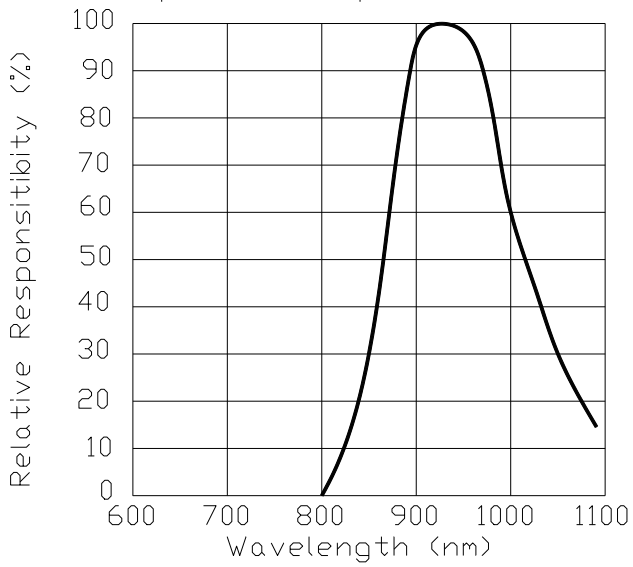

Fig.-5 Relative Transmission Distance vs. Direction

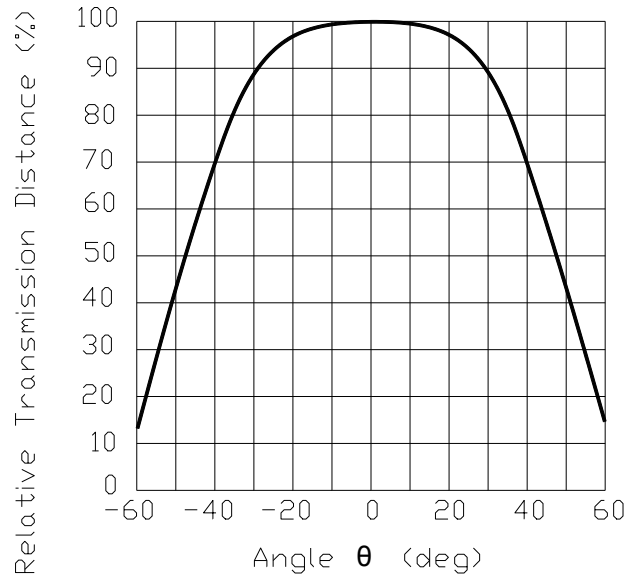

Fig.-6 Output Pulse Length vs. Arrival Distance

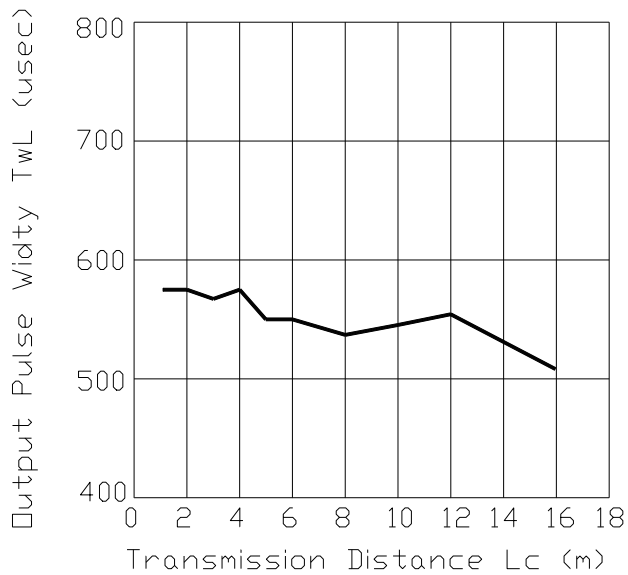

Fig.-7 Arrival Distance vs. Supply Voltage

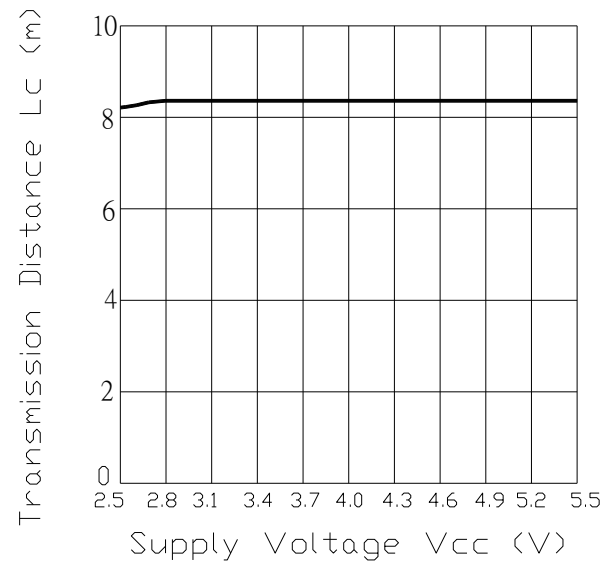

Fig.-8 Fig.-9 Relative Transmission Distance vs. Center Carrier Frequency

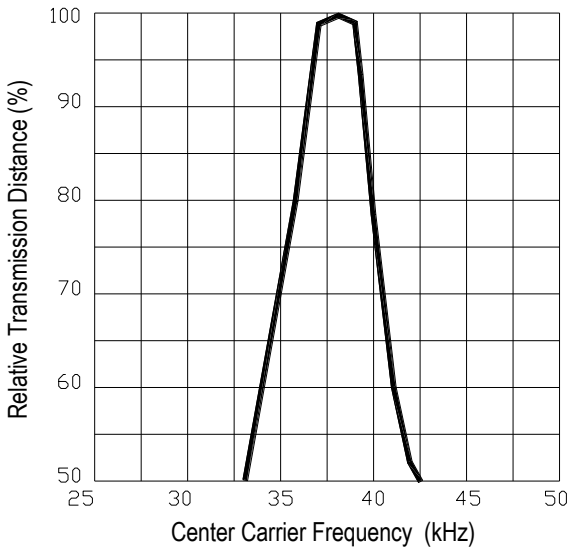
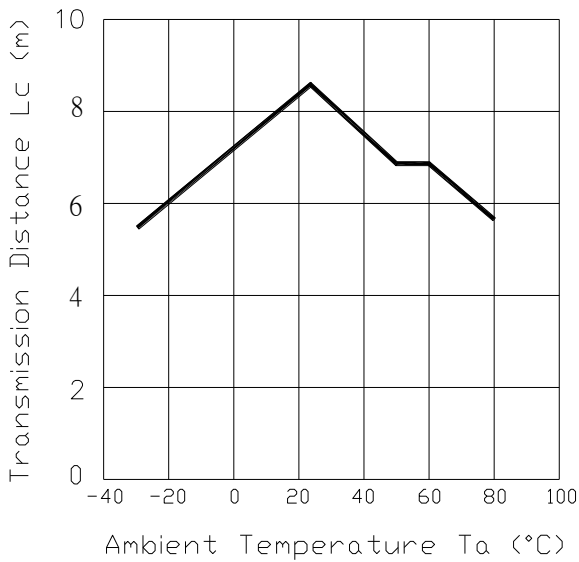
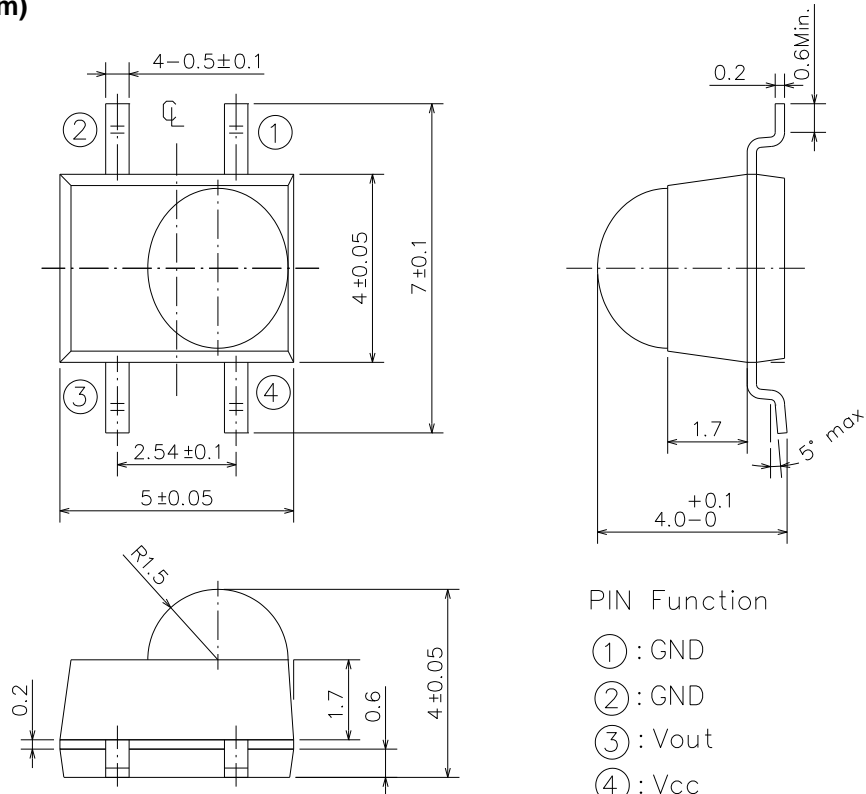

Fig.-9 Arrival Distance vs. Ambient Temperature



Package Dimensions

(Dimensions in mm)



- Notes :** 1.All dimensions are in millimeters.
 2.Tolerances unless dimensions ± 0.2 mm.

Soldering patterns

The following soldering patterns are recommended for reflow-soldering :

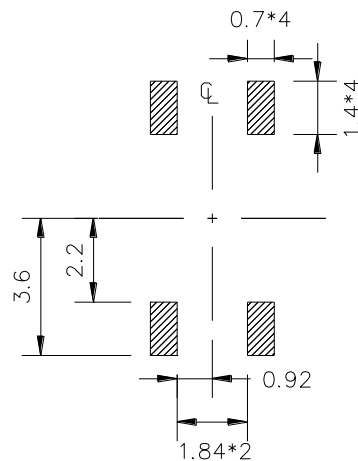

Code information

Protocol	Suitable	Protocol	Suitable
JVC	No	RCA	Yes
Matsushita	Yes	Sharp	Yes
Mitsubishi	No	Sony 12 Bit	Yes
NEC	Yes	Sony 15 Bit	No
RC5	Yes	Sony 20 Bit	No
RC6	Yes	Toshiba	Yes
Continuous Code	No	Zenith	Yes

Tape & Reel Packing Specifications

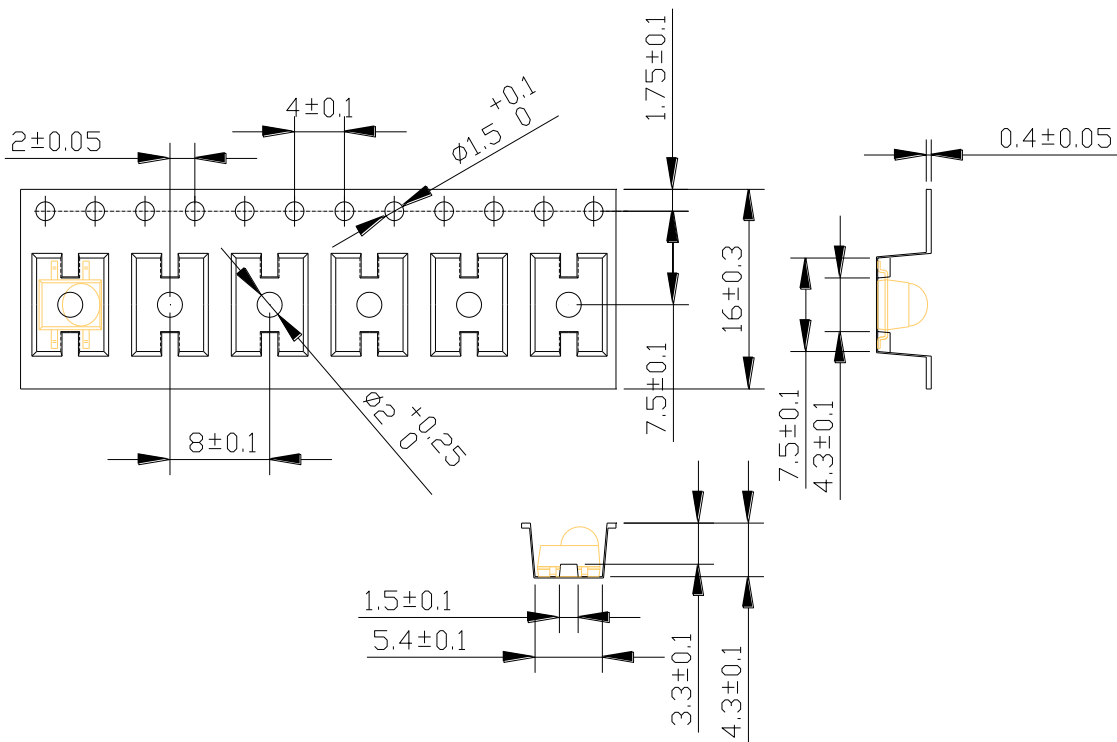

Packing Quantity

1000 pcs / Reel
 5 Reels / Carton

Packing process

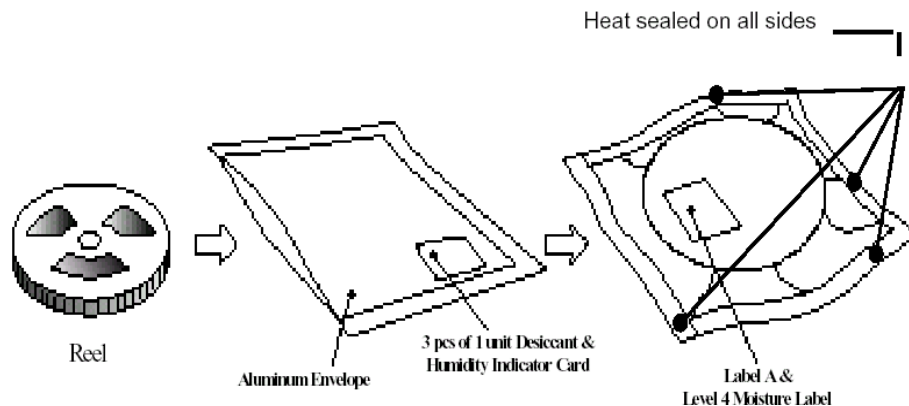

Label format

	EVERLIGHT
CPN:	
P/N: 30H6XXXXXX	
	RoHS
IRM-H6XXT/TR2	
QTY: 1000	CAT:
	HUE:
LOT NO:	REF:
MADE IN CHINA	

- CPN: Customer's Production Number
- P/N : Production Number
- QTY: Packing Quantity
- CAT: None
- HUE: None
- REF: Reference
- LOT No: Lot Number
- MADE IN CHINA: Production Place

Recommended method of storage

The following are general recommendations for moisture sensitive level (MSL) 4 storage and use:

1. Shelf life in sealed bag from the bag seal date: 12 months at $< 40\text{ }^{\circ}\text{C}$ and $< 90\%$ relative humidity (RH)
2. After bag is opened, devices that will be subjected to reflow solder or other high temperature process must be mounted within 72 hours of factory conditions $< 30\text{ }^{\circ}\text{C}/60\%\text{RH}$.
3. If the moisture absorbent material (silica gel) has faded away or the IRM has exceeded the storage time. Baking treatment is required, refer to IPC/JEDEC J-STD-033 for bake procedure or recommend the conditions: $60\pm 5\text{ }^{\circ}\text{C}$ for 96 hours.

ESD Precaution

Proper storage and handling procedures should be followed to prevent ESD damage to the devices especially when they are removed from the Anti-static bag. Electro-Static Sensitive Devices warning labels are on the packing.

Solder Reflow Temperature Profile

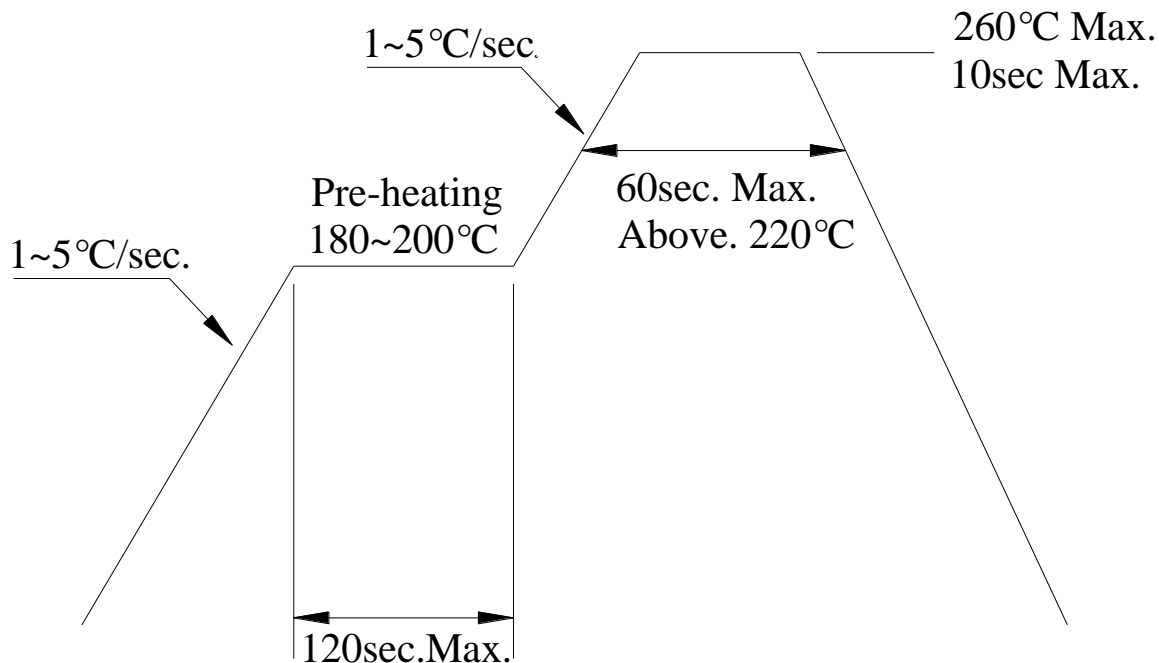

Note:

1. Reflow soldering should not be done more than two times.
2. When soldering, do not put stress on the IRM device during heating.
3. After soldering, do not warp the circuit board.

DISCLAIMER

1. Above specification may be changed without notice. Everlight Americas will reserve authority on material change for above specification.
2. When using this product, please observe the absolute maximum ratings and the instructions for use outlined in these specification sheets. Everlight Americas assumes no responsibility for any damage resulting from use of the product which does not comply with the absolute maximum ratings and the instructions included in these specification sheets.
3. These specification sheets include materials protected under copyright of Everlight Americas. Reproduction in any form is prohibited without the specific consent of Everlight Americas.