



User Manual

SOM-6894

ADVANTECH

Enabling an Intelligent Planet

Copyright

The documentation and the software included with this product are copyrighted 2013 by Advantech Co., Ltd. All rights are reserved. Advantech Co., Ltd. reserves the right to make improvements in the products described in this manual at any time without notice. No part of this manual may be reproduced, copied, translated or transmitted in any form or by any means without the prior written permission of Advantech Co., Ltd. Information provided in this manual is intended to be accurate and reliable. However, Advantech Co., Ltd. assumes no responsibility for its use, nor for any infringements of the rights of third parties, which may result from its use.

Acknowledgements

Intel is a trademark of Intel Corporation.

Microsoft Windows and MS-DOS are registered trademarks of Microsoft Corp.

All other product names or trademarks are properties of their respective owners.

Product Warranty (2 years)

Advantech warrants to you, the original purchaser, that each of its products will be free from defects in materials and workmanship for two years from the date of purchase.

This warranty does not apply to any products which have been repaired or altered by persons other than repair personnel authorized by Advantech, or which have been subject to misuse, abuse, accident or improper installation. Advantech assumes no liability under the terms of this warranty as a consequence of such events.

Because of Advantech's high quality-control standards and rigorous testing, most of our customers never need to use our repair service. If an Advantech product is defective, it will be repaired or replaced at no charge during the warranty period. For out-of-warranty repairs, you will be billed according to the cost of replacement materials, service time and freight. Please consult your dealer for more details.

If you think you have a defective product, follow these steps:

1. Collect all the information about the problem encountered. (For example, CPU speed, Advantech products used, other hardware and software used, etc.) Note anything abnormal and list any onscreen messages you get when the problem occurs.
2. Call your dealer and describe the problem. Please have your manual, product, and any helpful information readily available.
3. If your product is diagnosed as defective, obtain an RMA (return merchandise authorization) number from your dealer. This allows us to process your return more quickly.
4. Carefully pack the defective product, a fully-completed Repair and Replacement Order Card and a photocopy proof of purchase date (such as your sales receipt) in a shippable container. A product returned without proof of the purchase date is not eligible for warranty service.
5. Write the RMA number visibly on the outside of the package and ship it prepaid to your dealer.

Declaration of Conformity

CE

This product has passed the CE test for environmental specifications. Test conditions for passing included the equipment being operated within an industrial enclosure. In order to protect the product from being damaged by ESD (Electrostatic Discharge) and EMI leakage, we strongly recommend the use of CE-compliant industrial enclosure products.

FCC Class B

Note: This equipment has been tested and found to comply with the limits for a Class B digital device, pursuant to part 15 of the FCC Rules. These limits are designed to provide reasonable protection against harmful interference in a residential installation. This equipment generates, uses and can radiate radio frequency energy and, if not installed and used in accordance with the instructions, may cause harmful interference to radio communications. However, there is no guarantee that interference will not occur in a particular installation. If this equipment does cause harmful interference to radio or television reception, which can be determined by turning the equipment off and on, the user is encouraged to try to correct the interference by one or more of the following measures:

- Reorient or relocate the receiving antenna.
- Increase the separation between the equipment and receiver.
- Connect the equipment into an outlet on a circuit different from that to which the receiver is connected.
- Consult the dealer or an experienced radio/TV technician for help.

FM

This equipment has passed the FM certification. According to the National Fire Protection Association, work sites are classified into different classes, divisions and groups, based on hazard considerations. This equipment is compliant with the specifications of Class I, Division 2, Groups A, B, C and D indoor hazards.

Technical Support and Assistance

1. Visit the Advantech website at <http://support.advantech.com> where you can find the latest information about the product.
2. Contact your distributor, sales representative, or Advantech's customer service center for technical support if you need additional assistance. Please have the following information ready before you call:
 - Product name and serial number
 - Description of your peripheral attachments
 - Description of your software (operating system, version, application software, etc.)
 - A complete description of the problem
 - The exact wording of any error messages

Warnings, Cautions and Notes

Warning! *Warnings indicate conditions, which if not observed, can cause personal injury!*



Caution! *Cautions are included to help you avoid damaging hardware or losing data. e.g.*



There is a danger of a new battery exploding if it is incorrectly installed. Do not attempt to recharge, force open, or heat the battery. Replace the battery only with the same or equivalent type recommended by the manufacturer. Discard used batteries according to the manufacturer's instructions.

Note! *Notes provide optional additional information.*



Document Feedback

To assist us in making improvements to this manual, we would welcome comments and constructive criticism. Please send all such - in writing to: support@advan-tech.com

Packing List

Before setting up the system, check that the items listed below are included and in good condition. If any item does not accord with the table, please contact your dealer immediately.

- SOM-6894 CPU module
- 1 x Heatsreader (1960062204N001)

Safety Instructions

1. Read these safety instructions carefully.
2. Keep this User Manual for later reference.
3. Disconnect this equipment from any AC outlet before cleaning. Use a damp cloth. Do not use liquid or spray detergents for cleaning.
4. For plug-in equipment, the power outlet socket must be located near the equipment and must be easily accessible.
5. Keep this equipment away from humidity.
6. Put this equipment on a reliable surface during installation. Dropping it or letting it fall may cause damage.
7. The openings on the enclosure are for air convection. Protect the equipment from overheating. **DO NOT COVER THE OPENINGS.**
8. Make sure the voltage of the power source is correct before connecting the equipment to the power outlet.
9. Position the power cord so that people cannot step on it. Do not place anything over the power cord.
10. All cautions and warnings on the equipment should be noted.
11. If the equipment is not used for a long time, disconnect it from the power source to avoid damage by transient overvoltage.
12. Never pour any liquid into an opening. This may cause fire or electrical shock.
13. Never open the equipment. For safety reasons, the equipment should be opened only by qualified service personnel.
14. If one of the following situations arises, get the equipment checked by service personnel:
 - The power cord or plug is damaged.
 - Liquid has penetrated into the equipment.
 - The equipment has been exposed to moisture.
 - The equipment does not work well, or you cannot get it to work according to the user's manual.
 - The equipment has been dropped and damaged.
 - The equipment has obvious signs of breakage.
15. **DO NOT LEAVE THIS EQUIPMENT IN AN ENVIRONMENT WHERE THE STORAGE TEMPERATURE MAY GO BELOW -20° C (-4° F) OR ABOVE 60° C (140° F). THIS COULD DAMAGE THE EQUIPMENT. THE EQUIPMENT SHOULD BE IN A CONTROLLED ENVIRONMENT.**
16. **CAUTION: DANGER OF EXPLOSION IF BATTERY IS INCORRECTLY REPLACED. REPLACE ONLY WITH THE SAME OR EQUIVALENT TYPE RECOMMENDED BY THE MANUFACTURER, DISCARD USED BATTERIES ACCORDING TO THE MANUFACTURER'S INSTRUCTIONS.**

The sound pressure level at the operator's position according to IEC 704-1:1982 is no more than 70 dB (A).

DISCLAIMER: This set of instructions is given according to IEC 704-1. Advantech disclaims all responsibility for the accuracy of any statements contained herein.

Safety Precaution - Static Electricity

Follow these simple precautions to protect yourself from harm and the products from damage.

- To avoid electrical shock, always disconnect the power from your PC chassis before you work on it. Don't touch any components on the CPU card or other cards while the PC is on.
- Disconnect power before making any configuration changes. The sudden rush of power as you connect a jumper or install a card may damage sensitive electronic components.

Contents

Chapter 1	General Information	1
1.1	Introduction	2
1.2	Specifications	2
1.2.1	Board Information	2
1.2.2	System Information	2
1.2.3	Display	3
1.2.4	Expansion Interface	3
1.2.5	I/O	3
1.2.6	iManager 2.0	4
1.2.7	Mechanical and Environmental Specification	4
1.3	Functional Block Diagram	5
Chapter 2	Mechanical Information	7
2.1	Board Information.....	8
	Figure 2.1 Board Chips Identify - Front.....	8
	Figure 2.2 Board Chips Identify - Back	8
2.2	Mechanical Drawing.....	9
	Figure 2.3 Board Mechanical Drawing - Front	9
	Figure 2.4 Board Mechanical Drawing - Back	9
2.3	Assembly Drawing	10
	Figure 2.5 Assembly Drawing (For Reference Only).....	10
	Figure 2.6 Heatspreader Pre-Assembly (For Reference Only)..	10
2.4	Assembly Drawing	11
	Figure 2.7 Main Chip Height and Tolerance (GT2).....	11
	Figure 2.8 Main Chip Height and Tolerance (GT3).....	11
Chapter 3	AMI BIOS	13
3.1	Introduction	14
	Figure 3.1 BIOS Setup Utility Main Screen.....	14
3.2	Entering Setup	15
3.2.1	Main Setup.....	15
	Figure 3.2 Main setup screen	15
3.2.2	Advanced BIOS Features Setup.....	16
	Figure 3.3 Advanced BIOS Features Setup Screen	16
	Figure 3.4 ACPI Settings	17
	Figure 3.5 Trusted Computing	18
	Figure 3.6 CPU Configuration.....	19
	Figure 3.7 SATA Configuration.....	21
	Figure 3.8 PCH-FW Configuration.....	22
	Figure 3.9 Firmware Update Configuration.....	23
	Figure 3.10AMT Configuration.....	24
	Figure 3.11USB Configuration.....	25
	Figure 3.12Super IO Configuration	26
	Figure 3.13COM Port 1 Configuration	27
	Figure 3.14COM Port 2 Configuration	28
	Figure 3.15Parallel Port Configuration.....	29
	Figure 3.16PC Hardware Monitor	30
	Figure 3.17iManager Configuration	31
	Figure 3.18COM 3 Configuration.....	32
	Figure 3.19COM Port 4 Configuration	33
	Figure 3.20Hardware Monitor	34

	Figure 3.21 Serial Port Console Redirection	35
3.2.3	Chipset.....	36
	Figure 3.22 Chipset Setup.....	36
	Figure 3.23 PCH-IO Configuration	37
	Figure 3.24 PCI Express Configuration	38
	Figure 3.25 PCI Express Root Port 1 Configuration	39
	Figure 3.26 PCI Express Root Port 2 Configuration	40
	Figure 3.27 PCI Express Root Port 3 Configuration	42
	Figure 3.28 PCI Express Root Port 4 Configuration	43
	Figure 3.29 USB Configuration.....	45
	Figure 3.30 PCH Azalia Configuration.....	46
	Figure 3.31 System Agent (SA) Configuration	47
	Figure 3.32 Graphics Configuration.....	48
	Figure 3.33 LCD Control.....	49
	Figure 3.34 Memory Configuration	50
	Figure 3.35 GT- Power Management Control	51
3.2.4	Boot Settings	52
	Figure 3.36 Boot Setup Utility.....	52
	Figure 3.37 CSM parameters	53
3.2.5	Security Setup	54
	Figure 3.38 Security Setup.....	54
3.2.6	Save & Exit	55
	Figure 3.39 Save & Exit.....	55

Chapter 4 S/W Introduction & Installation..... 57

4.1	S/W Introduction	58
4.2	Driver Installation	58
	4.2.1 Windows Driver Setup	58
	4.2.2 Other OS.....	58
4.3	Advantech iManager	59

Appendix A Pin Assignment..... 61

A.1	SOM-6894 Type 6 Pin Assignment.....	62
-----	-------------------------------------	----

Appendix B Watchdog Timer..... 67

B.1	Programming the Watchdog Timer	68
-----	--------------------------------------	----

Appendix C Programming GPIO..... 69

C.1	GPIO Register.....	70
-----	--------------------	----

Appendix D System Assignments..... 71

D.1	System I/O Ports.....	72
	Table D.1: System I/O ports.....	72
D.2	DMA Channel Assignments	74
	Table D.2: DMA Channel Assignments	74
D.3	Interrupt Assignments	74
	Table D.3: Interrupt Assignments	74
D.4	Memory Map	75
	Table D.4: 1st MB Memory Map	75

Chapter 1

General Information

This chapter gives background information on the SOM-6894 CPU Computer on Module.

Sections include:

- Introduction
- Specification
- Functional Block Diagram

1.1 Introduction

SOM-6894 is a COM Express Compact module with pin-out Type 6 that fully complies with the PICMG (PCI Industrial Computer Manufacturers Group) COM.0 R2.1 specification. This product is designed with the latest Intel 4th generation ultra low power processors- Intel® Core™ i7-4650U, i5-4300U, i3-4010U, and Intel® Celeron 2980U which integrates the CPU and PCH onto one single chip. SOM-6894 has 15% CPU performance improvement than previous generation, GT3 graphics, and lower Thermal Design Power (TDP) 15W.

To compare with previous versions, SOM-6894 delivers improved graphics performance with the latest Intel® HD graphics with DX 11.1, OGL 3.2, OCL 1.2 support. It can support dual and triple independent displays for even better media and display capabilities. In addition, SOM-6894 features up to 16GB of DDR3L 1600MHz non-ECC un-buffered memory, 4 PCIe x1 (optional for 1 PCIe x4), 1 GLAN, 4 SATA, 2 USB 3.0, 8 USB 2.0, and 8 GPIO functions. Due to the outstanding performance, small form-factor, and rich expansion interfaces, this product is ideal for medical, digital signage, automation and surveillance applications.

Advantech iManager 2.0 was designed to satisfy a lot of embedded application requirements such as multi-level watchdog timer, voltage and temperature monitoring, thermal protection and mitigation through processor throttling, LCD backlight on/off and brightness control, embedded storage for customized information, etc. Combining Advantech SUSI Access, it can remotely monitor and control devices via the Internet for easy maintenance. All Advantech COM Express modules integrate iManager and SUSI Access to benefit customer's applications.

1.2 Specifications

1.2.1 Board Information

- **Pin Definition:** PICMG COM.0 R2.1 Type 6 pin-out definition
- **Form Factor:** PICMG COM.0 R2.1 Compact Module 95 x 95 mm

1.2.2 System Information

- **CPU:** 4th Generation Intel® Core Processor (U-Processor Line)

CPU+PCH	Standard Freq.	Intel® Turbo Boost Frequency 2.0 Max Single Core Turbo Frequency	Core	Cache (MB)	TDP(W)
i7-4650U	1.7 GHz	3.3 GHz	2	4	15
i5-4300U	1.9 GHz	2.9 GHz	2	3	15
i3-4010U	1.7 GHz	NA	2	3	15
2980U	1.6 GHz	NA	2	2	15

- **Chipset:** N/A
- **Memory:** 2 SODIMM Socket for DDR3L-1600, up to 16 GB
- **BIOS:** AMI UEFI BIOS @ 128Mb
- **Power management:** Supports power saving modes including Normal / Standby / Suspend modes. ACPI 2.0 compliant

1.2.3 Display

Graphic Core: Intel® HD Graphic supports DX11.1, OGL3.2, OCL1.2

CPU	Graphics Core	Base Freq.	Max Freq.
i7-4650U	Intel® HD graphics 5000	200 MHz	1.1 GHz
i5-4300U	Intel® HD graphics 4400	200 MHz	1.1 GHz
i3-4010U	Intel® HD Graphics 4400	200 MHz	1 GHz
2980U	Intel® HD Graphics	200 MHz	1 GHz

- **VGA:** Resolution up to 1920 x 1200
- **LVDS:** Supports single/dual channel 18/24-bit, resolution up to 1920 x 1200 @ 60 Hz
- **DDI (HDMI/DVI/DisplayPort):** Supports HDMI, DisplayPort, DVI (DDI2:Optional)
- **Resolution:**
 - HDMI up to 4096 x 2304 @24 Hz
 - DVI up to 1920 x 1200 @ 60 Hz
 - DP up to 3200 x 2000 @ 60 Hz
- **Dual Display:**
 - VGA + DP
 - VGA + HDMI
 - VGA + LVDS
 - LVDS + DP
 - LVDS + HDMI
- **Triple Display:**
 - VGA + LVDS + DP
 - VGA + LVDS + HDMI

1.2.4 Expansion Interface

- **PCI Express x1:** Supports 4 PCIe x1 compliant ports by default.

	x4	x2	x1
Default	0	0	4
Option 1	1	0	0

- **Audio Interface:** Intel HD Audio interface
- **LPC Bus:** Yes (24 MHz)
- **SMBus:** Yes
- **I2C Bus:** up to 1 MB/s
- **SPI:** Supports SPI BIOS only

1.2.5 I/O

- **Ethernet:** Intel i218LM Gigabit LAN supports 10/100/1000 Mbps Speed
- **SATA:** Supports 4 ports SATA Gen2 (3 Gb/s) and Gen3 (6Gb/s), RAID 0, 1, 5, 10
- **USB Interface:** Supports 2 ports USB3.0, 8 ports USB 2.0
- **Panel Control:** Supports panel backlight on/off control, brightness control
- **Thermal Protection:** Supports thermal shutdown or CPU throttling
- **Watchdog Timer:** 65536 level timer interval, from 0 ~ 65535 sec
- **Smart Fan:** 2 Ports; 1 Port on COM Module. Support 12V Fan, 1 Port on Carrier Board

- **GPIO:** 8-bit GPIO
- **Power Supply Voltage:** ATX (Vin 4.75-20V, Vsb 4.75-5.25V)
- **TPM:** N/A

1.2.6 iManager 2.0

Refer to section 4.3.

1.2.7 Mechanical and Environmental Specification

- **Dimensions:** 95 x 95 mm (3.74" x 3.74")
- **Power Type and Supply Voltage:**
 - ATX (Vin 4.75 - 20 V, Vsb 4.75 - 5.25 V)
- **Power Requirement:**
 - Test condition: Intel core i7-4650U CPU @ 1.70 GHz, Intel core i5-4300U CPU @ 1.90 GHz, Intel core i3-4010U CPU @ 1.70 GHz, ADVANTECH 8 G DDR3L-1600 I-GRD*2, WIN7 32-bit, Rated voltage DC +4.75 V, +12 V, +21 V
 - Idle: +12 V @ 0.37A (i7), 0.35A (i5), 0.37A (i3), 0.34A (Celeron)
 - Max: +12 V @ 1.72A(i7), 1.31A(i5), 1.13A (i3), 0.95A (Celeron)
- **Temperature Specification:**
 - Operating: 0 ~ 60° C (32 ~ 140° F)
 - Storage: -40 ~ 85° C (-40 ~ 185° F)
- **Humidity Specification:**
 - Operating: 40° C @ 95% relative humidity, non-condensing
 - Storage: 60° C @ 95% relative humidity, non-condensing

Note!  Based on Intel's document, the Advanced Configuration and Power Interface, Version 2.0b defines an optional Sleep button. It differs from the power button in that it only is a request to go from S0 to S1-S4 (not S5). Also, in an S5 state, the Power Button can wake the system, but the Sleep Button cannot.

This is partial compatible with PICMG COM.0 R2.1 spec for SOM-6894. If customer would like to have the wake up function, this function can be worked via wake signal or power button.

1.3 Functional Block Diagram

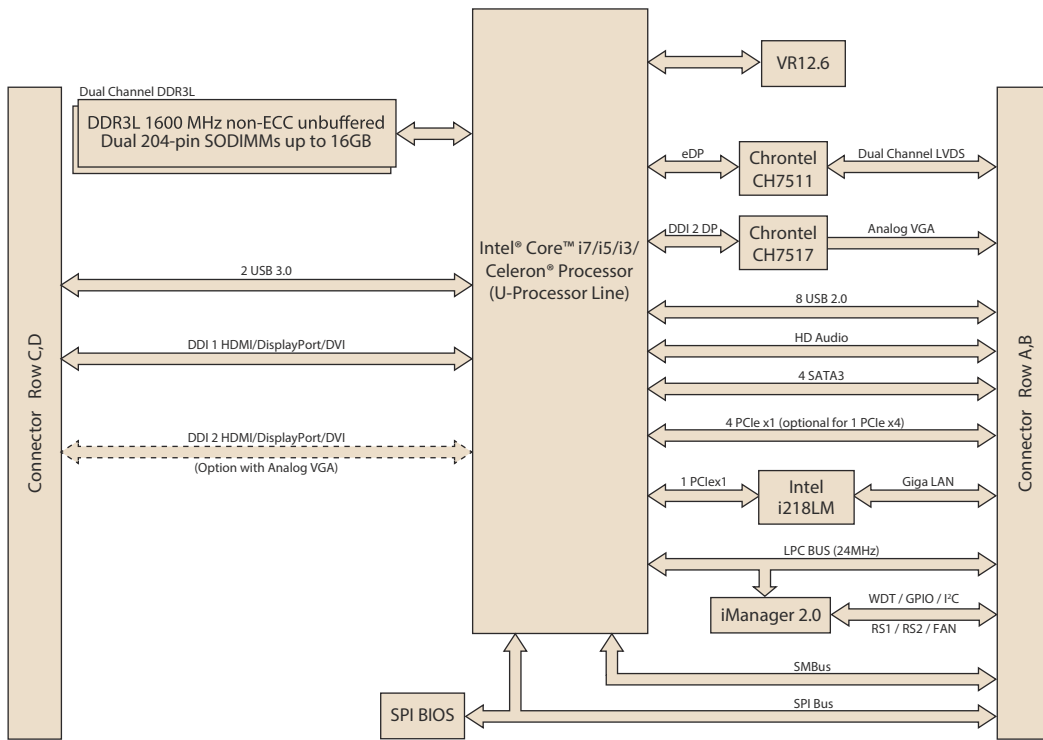

Chapter 2

Mechanical Information

This chapter gives mechanical information on the SOM-6894 CPU Computer on Module.

Sections include:

- Board Information
- Mechanical Drawing
- Assembly Drawing

2.1 Board Information

The figures below indicate the main chips on SOM-6894 Computer-on-Module. Please aware of these positions while designing your own carrier board to avoid mechanical issues, as well as designing thermal solution contact points for best thermal dissipation performance.

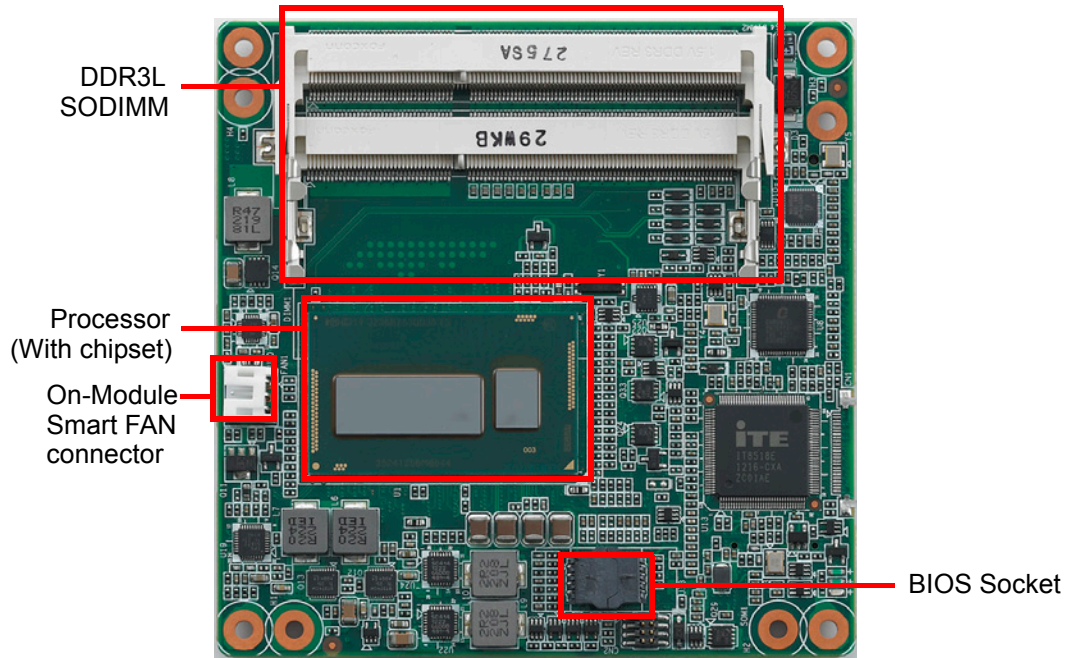

Figure 2.1 Board Chips Identify - Front

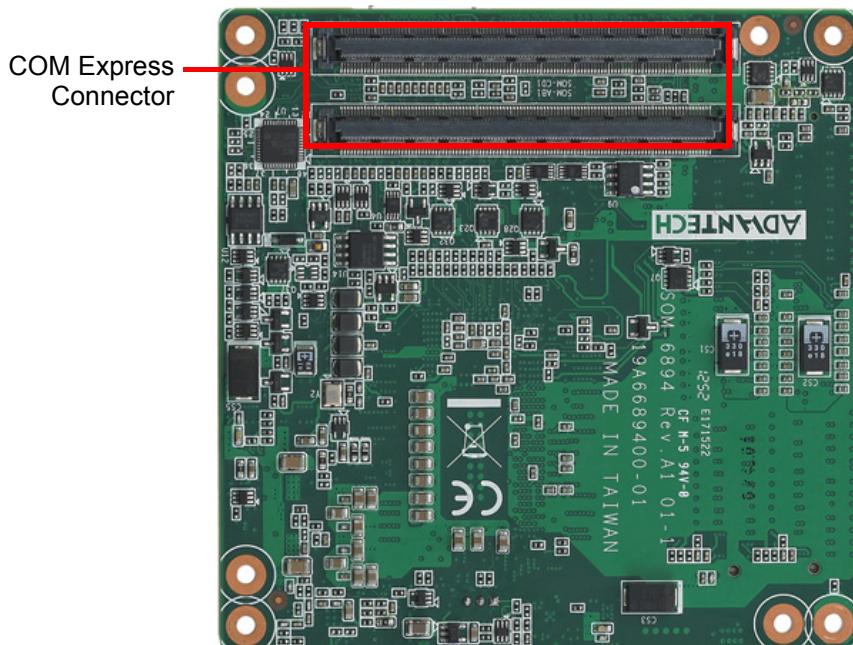

Figure 2.2 Board Chips Identify - Back

2.2 Mechanical Drawing

For more details about 2D/3D models, please look on the Advantech COM support service website <http://com.advantech.com>.

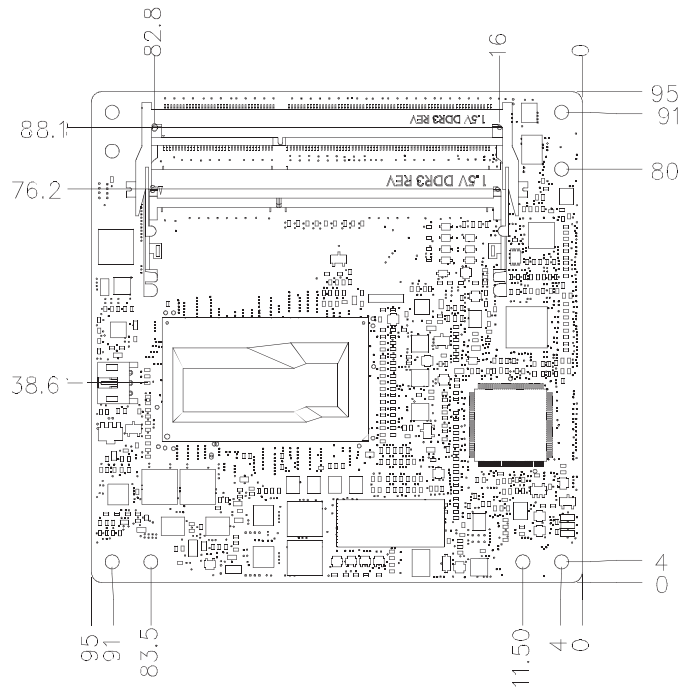

Figure 2.3 Board Mechanical Drawing - Front

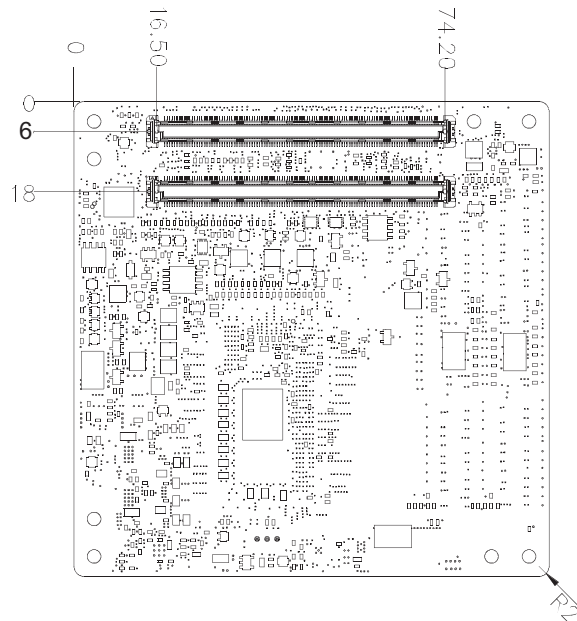

Figure 2.4 Board Mechanical Drawing - Back

2.3 Assembly Drawing

These figures demonstrate the assembly order from thermal module, COM module to carrier board.

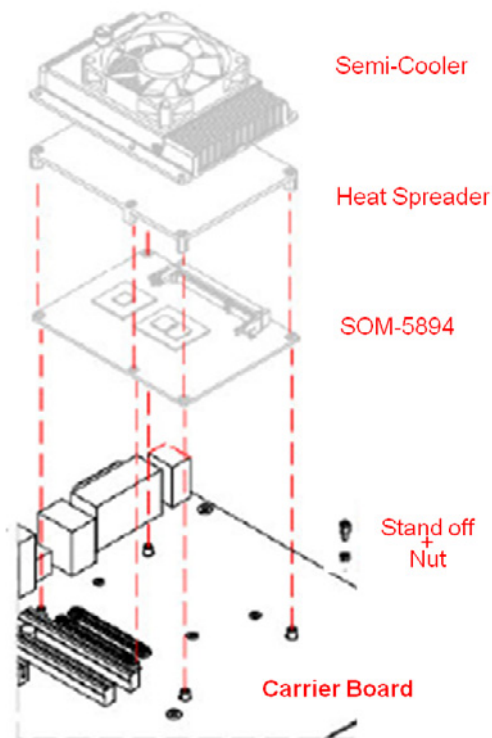

Figure 2.5 Assembly Drawing (For Reference Only)

There are 4 reserved screw holes for SOM-6894 to be pre-assembled with heat spreader.

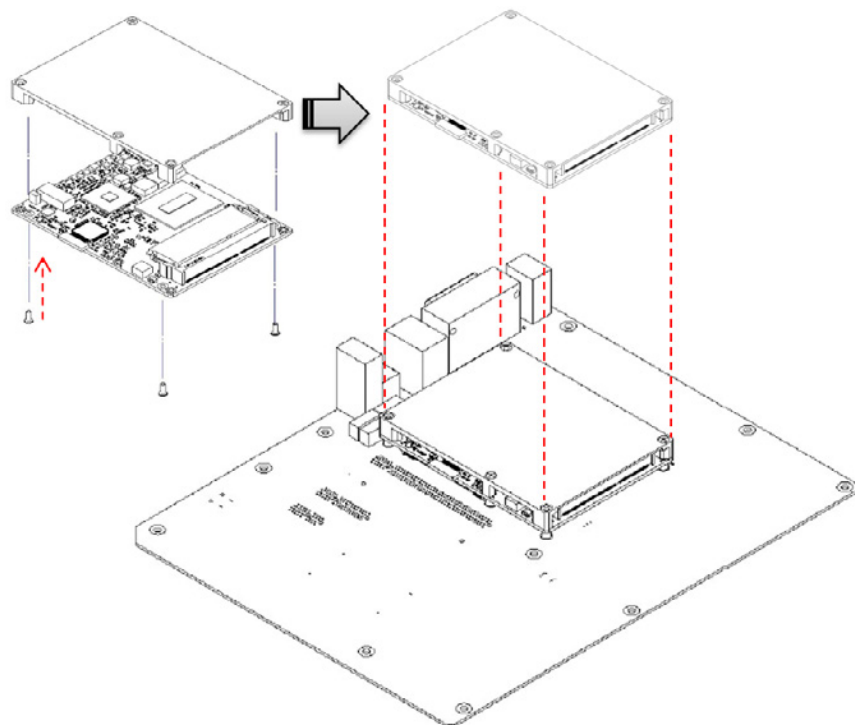
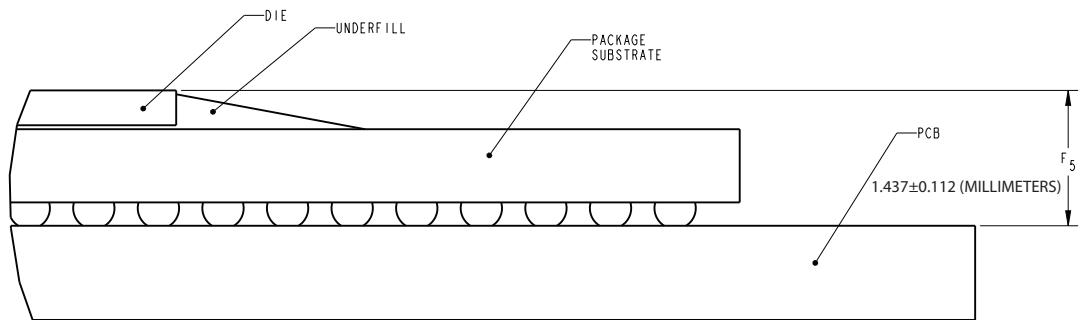

Figure 2.6 Heatspreader Pre-Assembly (For Reference Only)

2.4 Assembly Drawing

Please consider the CPU and chip height tolerance when designing your thermal solution.



*F5=NOM : 1.437 TOL:±0.112 (POST SMT STACKUP HEIGHT BASED ON LIMITED DATA FROM INTEL REFERENCE BOARD DESIGN)

Figure 2.7 Main Chip Height and Tolerance (GT2)

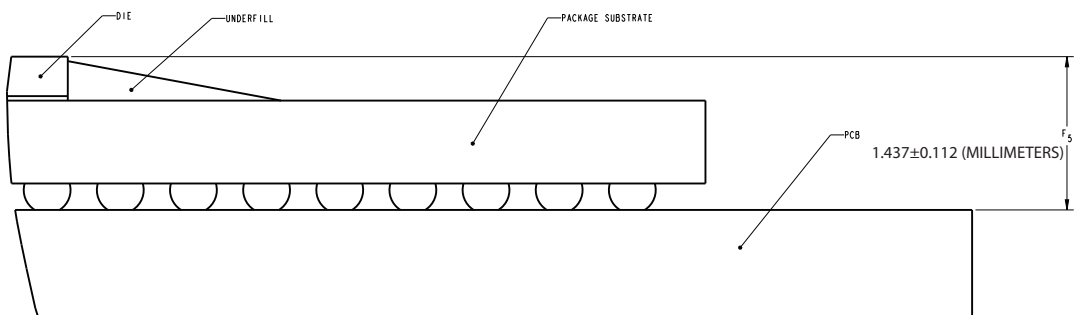

*F5=NOM : 1.437 TOL:±0.112 (POST SMT STACKUP HEIGHT BASED ON LIMITED DATA FROM INTEL REFERENCE BOARD DESIGN)

Figure 2.8 Main Chip Height and Tolerance (GT3)

Chapter 3

AMI BIOS

Sections include:

- Introduction
- Entering Setup

3.1 Introduction

AMI BIOS has been integrated into many motherboards for over a decade. With the AMI BIOS Setup program, users can modify BIOS settings and control various system features. This chapter describes the basic navigation of the BIOS Setup Utility.

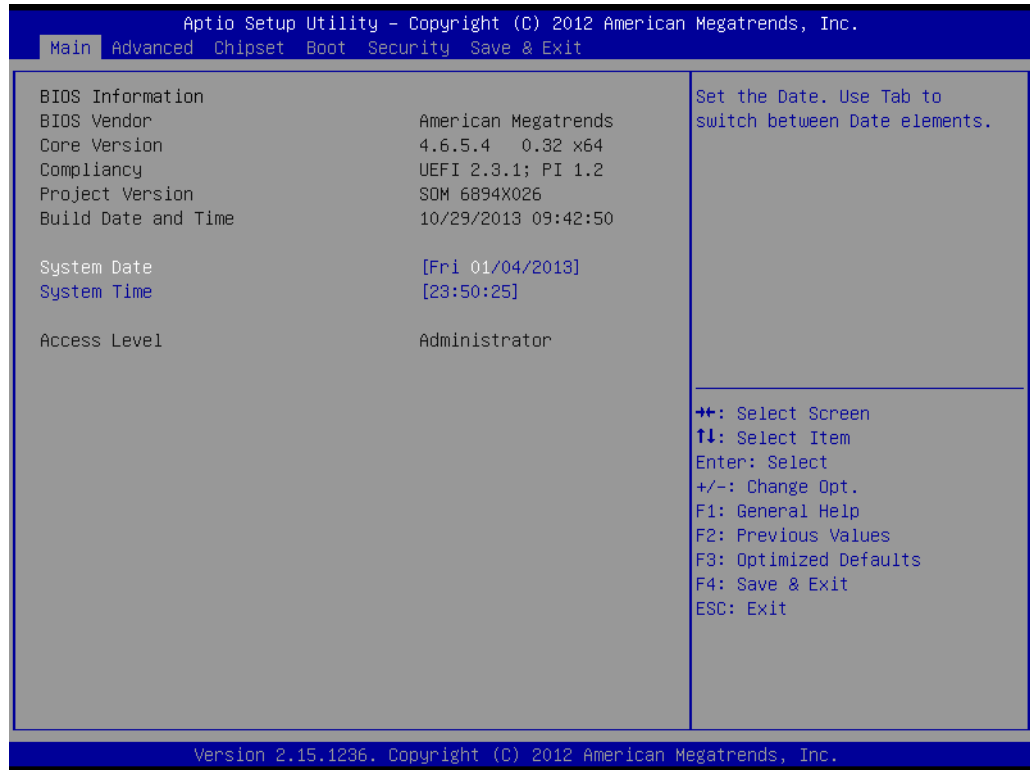

Figure 3.1 BIOS Setup Utility Main Screen

AMI's BIOS ROM has a built-in Setup program that allows users to modify the basic system configuration. This information is stored in flash ROM so it retains the Setup information when the power is turned off.

3.2 Entering Setup

Turn on the computer and then press <F2> or to enter Setup menu.

3.2.1 Main Setup

When users first enter the BIOS Setup Utility, users will enter the Main setup screen. Users can always return to the Main setup screen by selecting the Main tab. There are two Main Setup options. They are described in this section. The Main BIOS Setup screen is shown below.

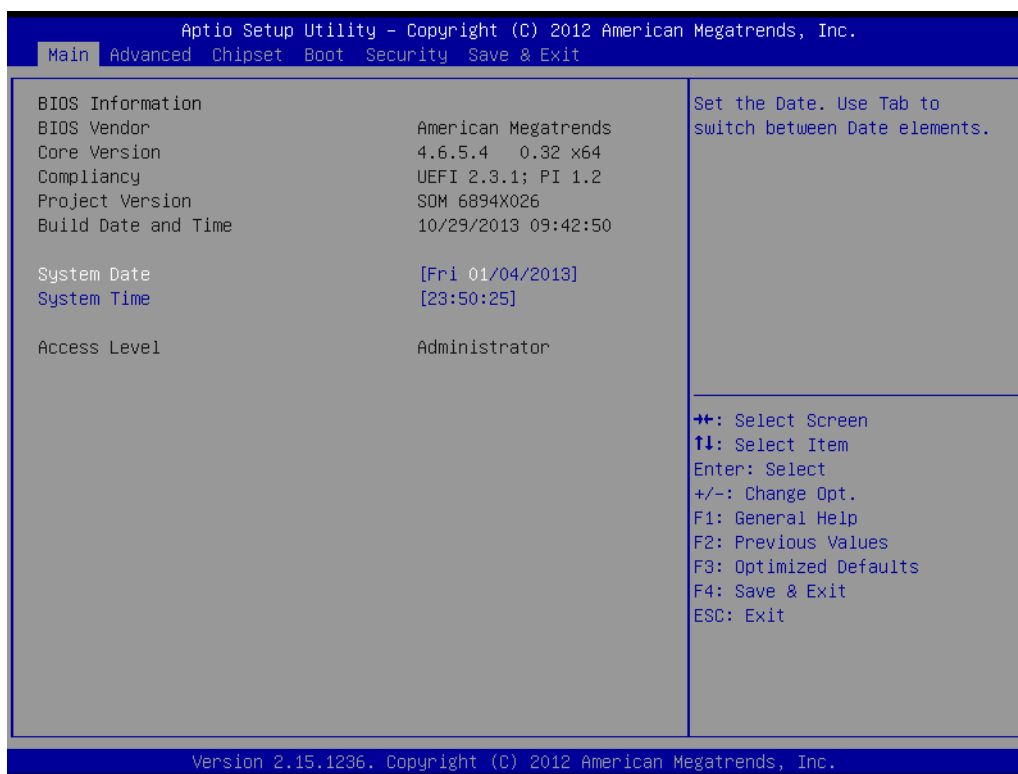

Figure 3.2 Main setup screen

The Main BIOS setup screen has two main frames. The left frame displays all the options that can be configured. Grayed-out options cannot be configured; options in blue can. The right frame displays the key legend.

Above the key legend is an area reserved for a text message. When an option is selected in the left frame, it is highlighted in white. Often a text message will accompany it.

■ System time / System date

Use this option to change the system time and date. Highlight System Time or System Date using the <Arrow> keys. Enter new values through the keyboard. Press the <Tab> key or the <Arrow> keys to move between fields. The date must be entered in MM/DD/YY format. The time must be entered in HH:MM:SS format.

3.2.2 Advanced BIOS Features Setup

Select the Advanced tab from the SOM-6894 setup screen to enter the Advanced BIOS Setup screen. Users can select any item in the left frame of the screen, such as CPU Configuration, to go to the sub menu for that item. Users can display an Advanced BIOS Setup option by highlighting it using the <Arrow> keys. All Advanced BIOS Setup options are described in this section. The Advanced BIOS Setup screens are shown below. The sub menus are described on the following pages.

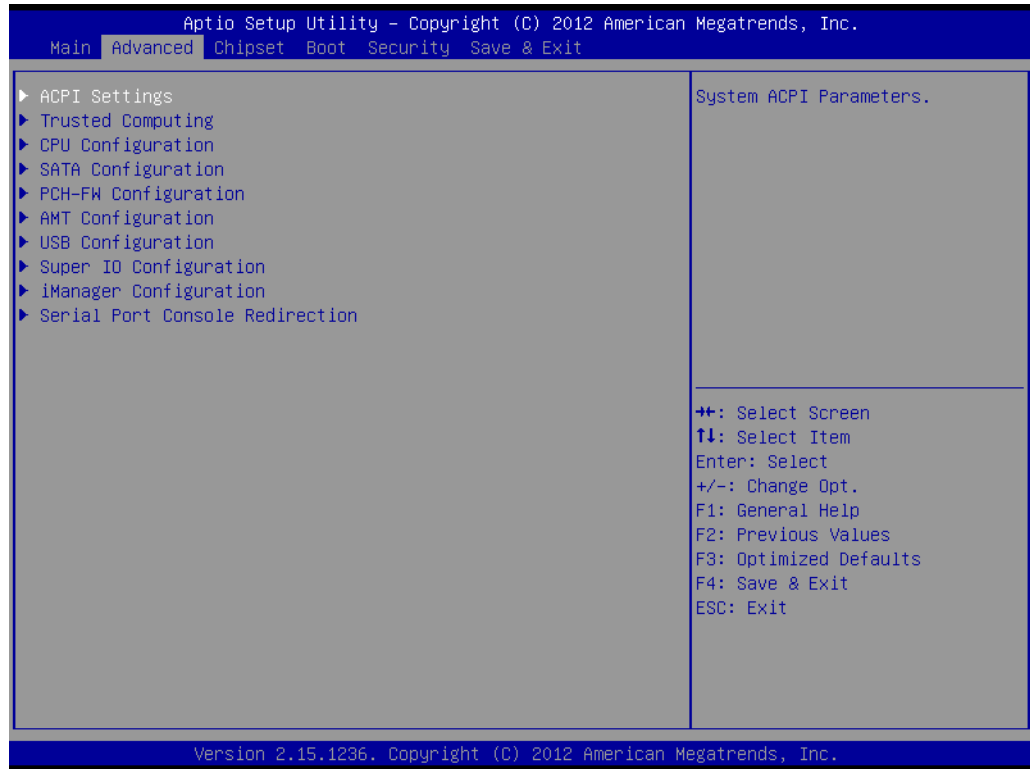

Figure 3.3 Advanced BIOS Features Setup Screen

3.2.2.1 ACPI Settings

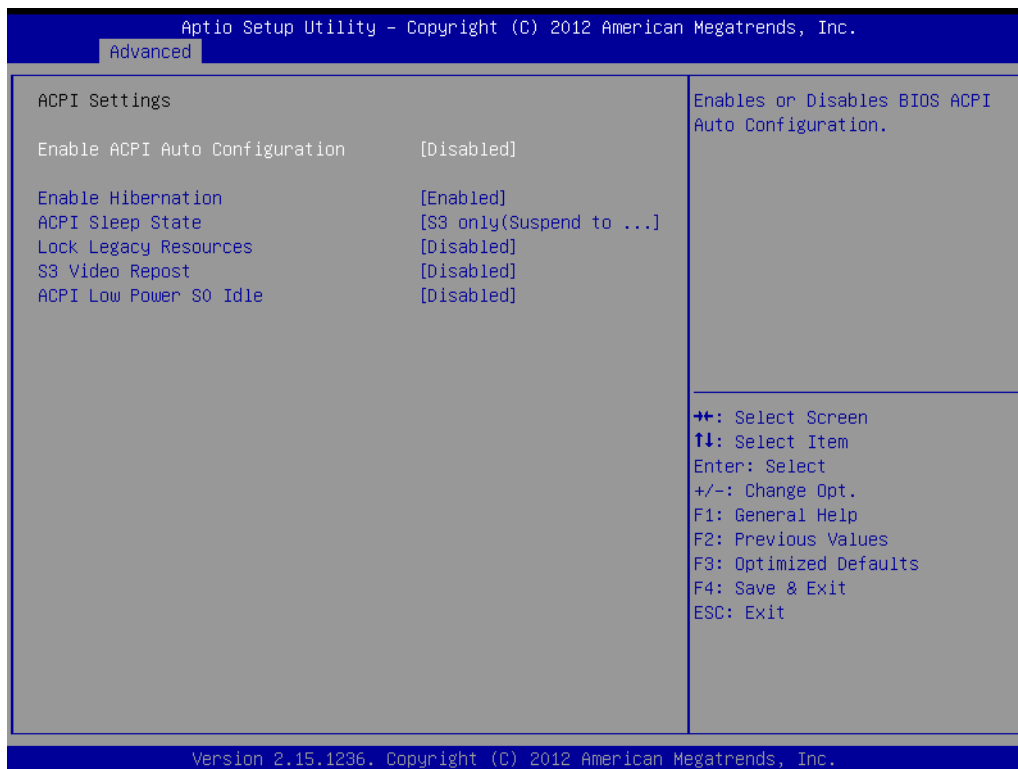

Figure 3.4 ACPI Settings

- **Enable ACPI Auto Configuration**
This item allows users to enable or disable BIOS ACPI auto configuration.
- **Enable Hibernation**
This item allows users to enable or disable System ability to hibernate (OS/S4 sleep State). This option may be not effective with some OS.
- **ACPI Sleep State**
This item allows users to select the ACPI sleep state. The system will enter when the SUSPEND button is pressed.
- **Lock Legacy Resources**
This item allows users to enable or disable Lock of Legacy Resources.
- **S3 Video Repost**
This item allows users to enable or disable S3 Video Repost.
- **ACPI Low Power S0 Idle**
This item allows users to enable or disable ACPI Low Power S0 Idle support.

3.2.2.2 Trusted Computing

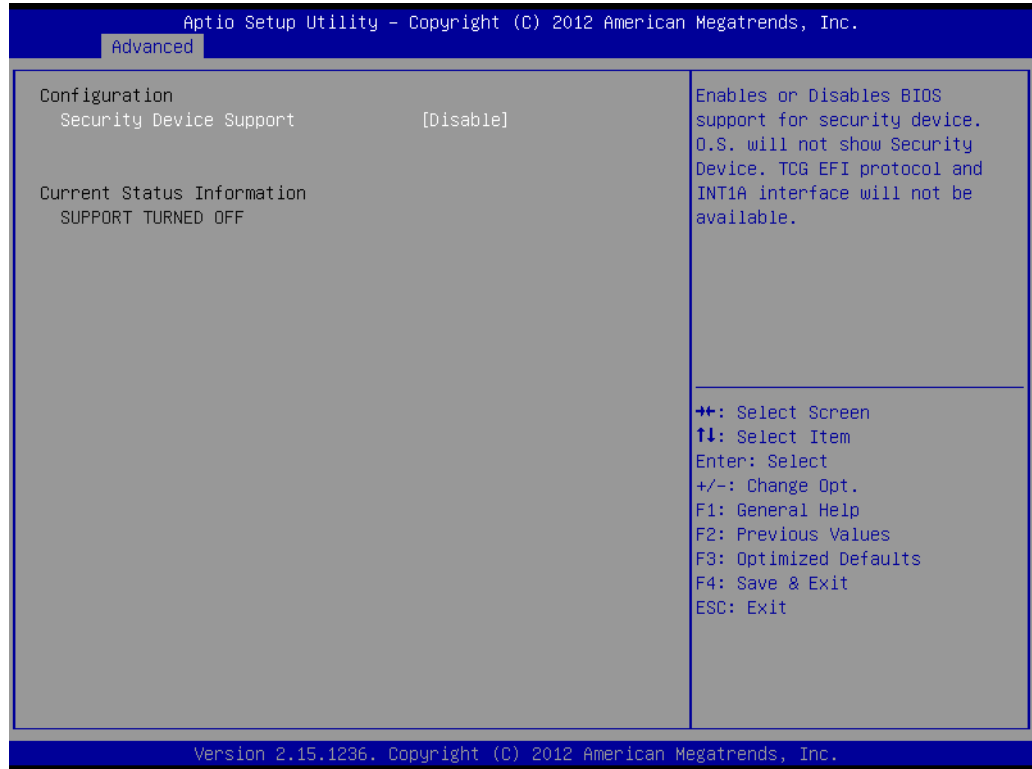

Figure 3.5 Trusted Computing

- **Security Device Support**

This item allows users to enable or disable BIOS support for security device support, and the OS will not show the Security Device. TCG EFI Protocol and INT1A interface will not be available.

3.2.2.3 CPU Configuration

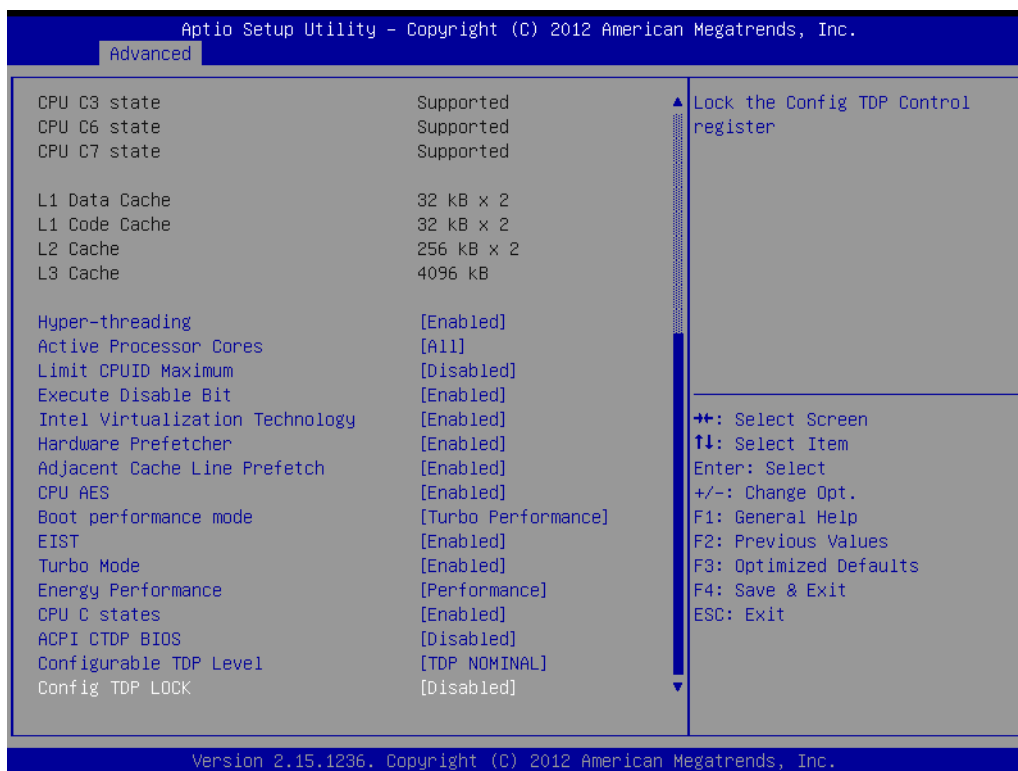

Figure 3.6 CPU Configuration

- **Hyper-threading**
 Enable for Windows XP and Linux (OS optimized for Hyper-Threading Technology) and Disable for other OS (OS not optimized for Hyper-Threading Technology) and Disable for other OS (OS not optimized for Hyper-Threading Technology). When Disabled only one thread per core is enabled.
- **Active Processor Cores**
 This item allows users to enable a number of cores in each processor package.
- **Limit CPUID Maximum**
 Disable for Windows XP.
- **Execute Disable Bit**
 This item allows users to enable or disable Execute Disable Bit.
 XD can prevent certain classes of malicious buffer overflow attacks when combined with a supporting OS (Windows server 2003 SP1, Windows XP SP2 SuSE Linux 9.2, RedHat Enterprise 3 update 3.)
- **Intel Virtualization Technology**
 This item allows users to enable or disable Intel Virtualization Technology.
 When enabled, a VMM can utilize the additional hardware capabilities provided by Vanderpool Technology.
- **Hardware Prefetcher**
 This item allows users to enable or disable Hardware Prefetcher.
 Enable the Mid Level Cache (L2) streamer prefetcher.
- **Adjacent Cache Line Prefetch**
 This item allows users to enable or disable Adjacent Cache Line Prefetch.
 Enable the Mid Level Cache (L2) prefetching of adjacent cache lines.

-
- **CPU AES**
This item allows users to enable or disable CPU Advanced Encryption Standard instructions.
 - **Boot performance mode**
This Item allows users to select the performance state that the BIOS will set before OS handoff.
 - **EIST**
This item allows users to enable or disable Intel SpeedStep.
 - **Turbo Mode**
This item allows users to enable or disable Turbo Mode.
 - **Energy Performance**
This Item allows users to optimize between performance and power savings.
 - **CPU C states**
This item allows users to enable or disable CPU C states.
 - **ACPI CTDP BIOS**
This item allows users to enable or disable ACPI CTDP BIOS support.
 - **Configurable TDP Level**
This Item allows users to select Configurable TDP Level.
Allow re-configuration of TDP levels based on current power and thermal delivery capabilities of the system.
 - **Config TDP Lock**
This item allows users to enable or disable Config TDP Lock.
Locks the Config TDP Control register.

3.2.2.4 SATA Configuration

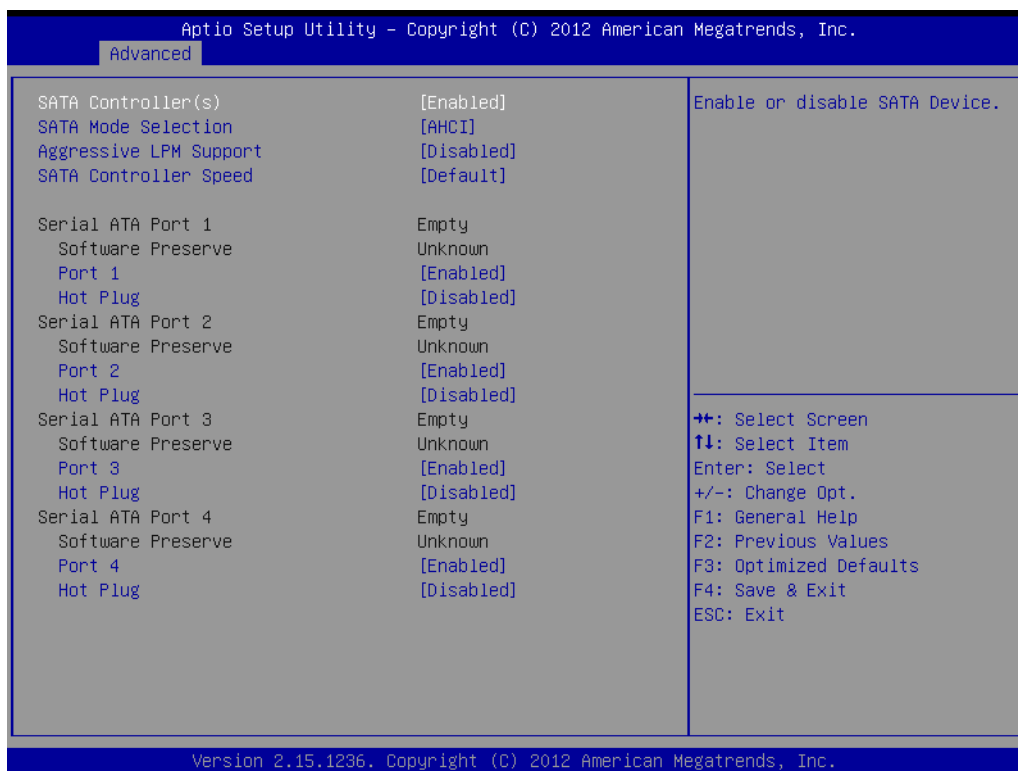

Figure 3.7 SATA Configuration

- **SATA Controller(s)**
This item allows users to enable or disable SATA devices.
- **SATA Mode Selection**
This item allows users to select SATA mode selection. (Determines how SATA controller(s) operate)
- **Aggressive LPM Support**
This item allows users to enable or disable PCH to aggressively enter link power state.
- **SATA Controller Speed**
Indicates the maximum speed the SATA controller can support.
- **Serial ATA Port 1**
 - **Port 1**
This item allows users to enable or disable the Serial ATA Port.
 - **Hot Plug**
Designates this port as Hot Pluggable.
- **Serial ATA Port 2**
 - **Port 2**
This item allows users to enable or disable Serial ATA Ports.
 - **Hot Plug**
Designates this port as Hot Pluggable.
- **Serial ATA Port 3**
 - **Port 3**
This item allows users to enable or disable Serial ATA Port.
 - **Hot Plug**

Designates this port as Hot Pluggable.

- **Serial ATA Port 4**

- **Port 4**

- This item allows users to enable or disable Serial ATA Ports.

- **Hot Plug**

- Designates this port as Hot Pluggable.

3.2.2.5 PCH-FW Configuration



Figure 3.8 PCH-FW Configuration

- **MDES BIOS Status Code**

- This item allows users to enable or disable MDES BIOS status code.

- **TPM Device Selection**

- This item allows users to enable or disable TPM Device Selection. (PTT or dTPM. PTT-Enables PTT in SkuMgr dTPM 1.2- Disables PTT in SkuMgr Warning! PTT/dTPM will be disable and all data saved on it will be lost.

- **Firmware Update Configuration**

- Configure Management Engine Technology Parameters

■ Firmware Update Configuration

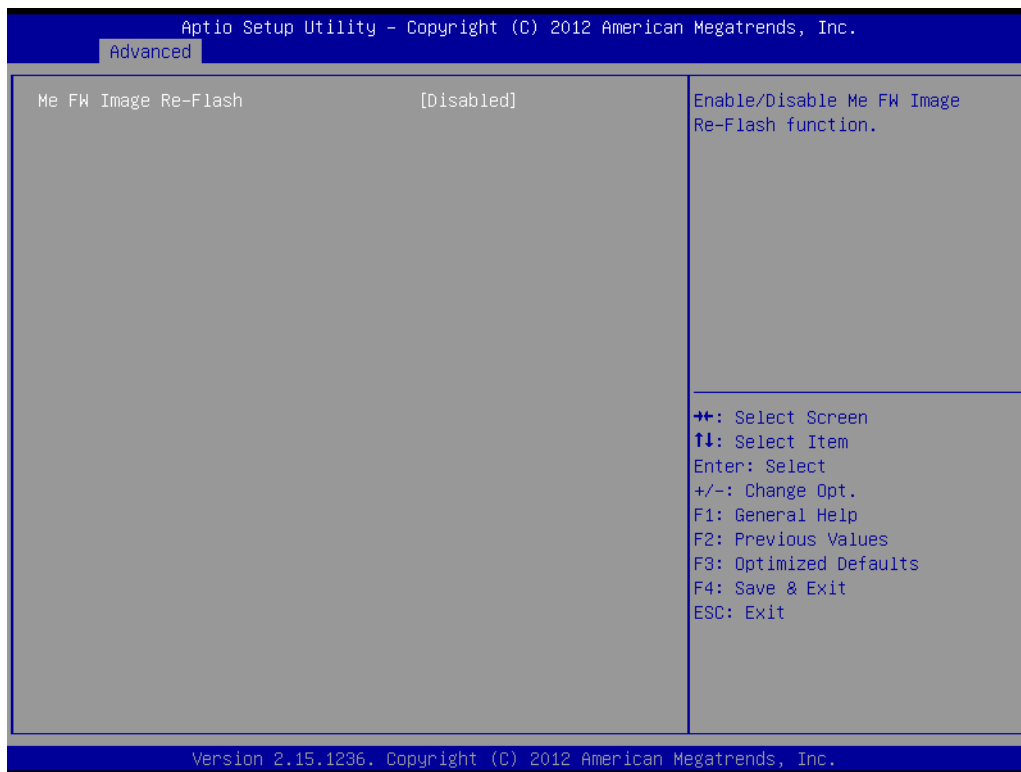

Figure 3.9 Firmware Update Configuration

– ME FW Image Re-Flash

This item allows users to enable or disable ME FW Image Re-Flash function.

3.2.2.6 AMT Configuration

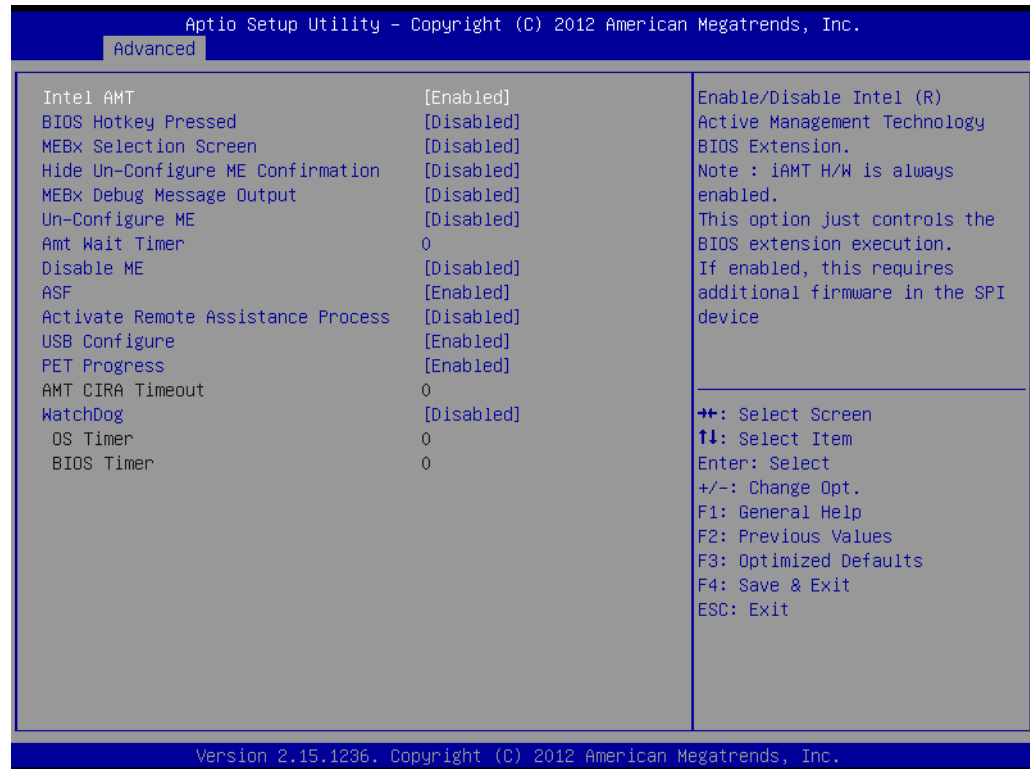

Figure 3.10 AMT Configuration

- **Intel AMT**

This item allows users to enable or disable Intel AMT (Active Management Technology) BIOS Extension.

Note! *iAMT H/W is always enable. This option just controls the BIOS extension execution. If enabled, this requires additional firmware in the SPI device.*



- **BIOS Hotkey Pressed**

This item allows users to enable or disable BIOS Hotkey Pressed.

- **MEBx Selection Screen**

This item allows users to enable or disable MEBx Selection Screen.

- **Hide Un-Configure ME Confirmation**

This item allows users to hide un-configure ME without password confirmation prompt.

- **MEBx Debug Message Output**

This item allows users to enable or disable MEBx Debug Message Output.

- **Un-Configure ME**

This item allows users to enable or disable Un-Configure ME.

- **Amt Wait Timer**

This item allows users to set timer to wait before sending ASF_GET_BOOT_OPTIONS.

- **Disable ME**

This item allows users to set ME to Soft Temporary disabled.

- **ASF**

This item allows users to enable or disable Alert Specification Format.

- **Activate Remote Assistance Process**

This item allows users to enable or disable Activate Remote Assistance Process.

To Trigger CIRA boot.

- **USB Configure**

This item allows users to enable or disable USB Configure function.

- **PET Progress**

This item allows users to enable or disable PET Events progress to receive PET events or not.

- **WatchDog**

This item allows users to enable or disable WatchDog.

3.2.2.7 USB Configuration

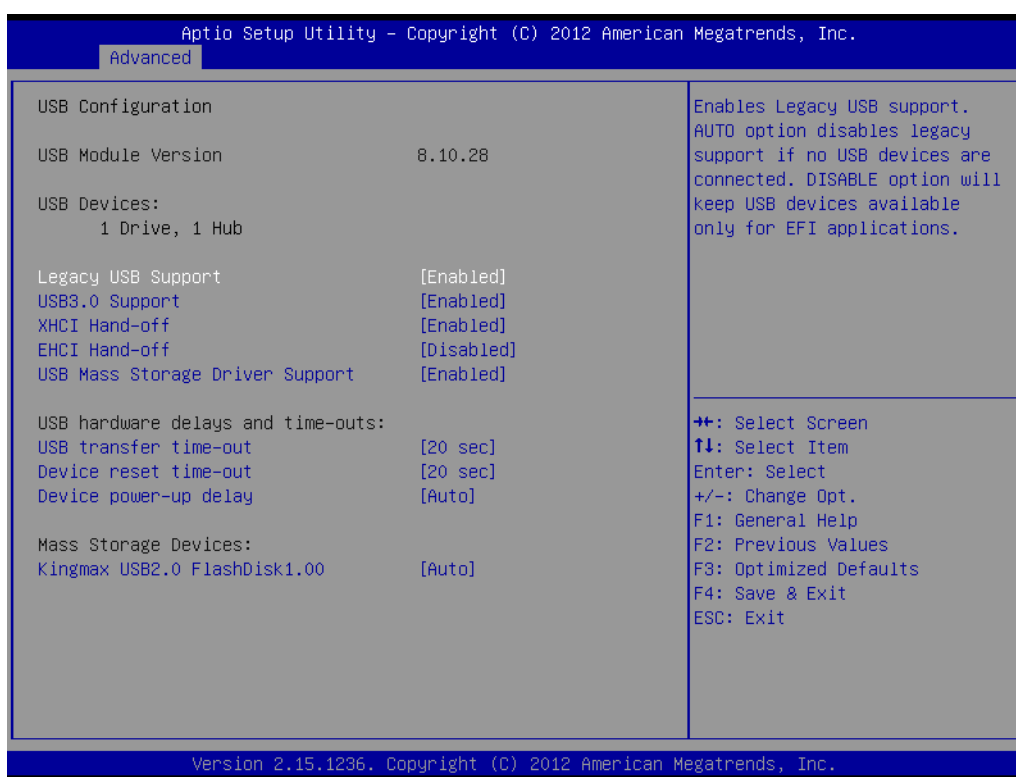

Figure 3.11 USB Configuration

- **Legacy USB Support**

This item allows users to enable or disable Legacy USB Support.

Auto option disables legacy support if no USB devices are connected.

Disable option will keep USB devices available only for EFI applications.

- **USB3.0 Support**

This item allows users to enable or disable USB3.0 (XHCI) controller support.

- **XHCI Hand-off**

This item allows users to enable or disable XHCI Hand-off.

This is a workaround for OS without XHCI hand-off support. The XHCI ownership change should be claimed by XHCI driver.

- **EHCI Hand-off**

This item allows users to enable or disable EHCI Hand-off.

This is a workaround for OS without EHCI hand-off support. The EHCI ownership change should be claimed by EHCI driver.

- **USB Mass Storage Driver Support**

This item allows users to enable or disable USB Mass Storage Driver Support.

- **USB transfer time-out**

This item allows users to select time-out section.

The time-out value for control, bulk, and interrupt transfers.

- **Device reset time-out**

This item allows users to select device time-out section.

USB mass storage devices start unit command time-out.

- **Device power-up delay**

This item allows users to select device power-up section.

Maximum time the device will take before it properly reports itself to the Host controller. "Auto" uses a default value: for a Root port it is 100ms, for a Hub port the delay is taken from the Hub descriptor.

- **USB2.0 FlashDisk1.00**

This item allows users to select USB2.0 FlashDisk1.00 section.

Mass storage device emulation type. "Auto" enumerates devices according to their media format. Optical drives are emulated as "CDROM" drives with no media will be emulated according to a drive type.

3.2.2.8 Super IO Configuration



Figure 3.12 Super IO Configuration

- **COM Port 1 Configuration**

This item allows user to set Parameters of COM Port 1.

- **COM Port 2 Configuration**

This item allows user to set Parameters of COM Port 2.

- **Parallel Port Configuration**
This item allows users to set Parameters of Parallel Port (LPT/LPTE).
- **Hardware Monitor**
This item allows user to change monitor hardware status.
- **COM Port 1 Configuration**

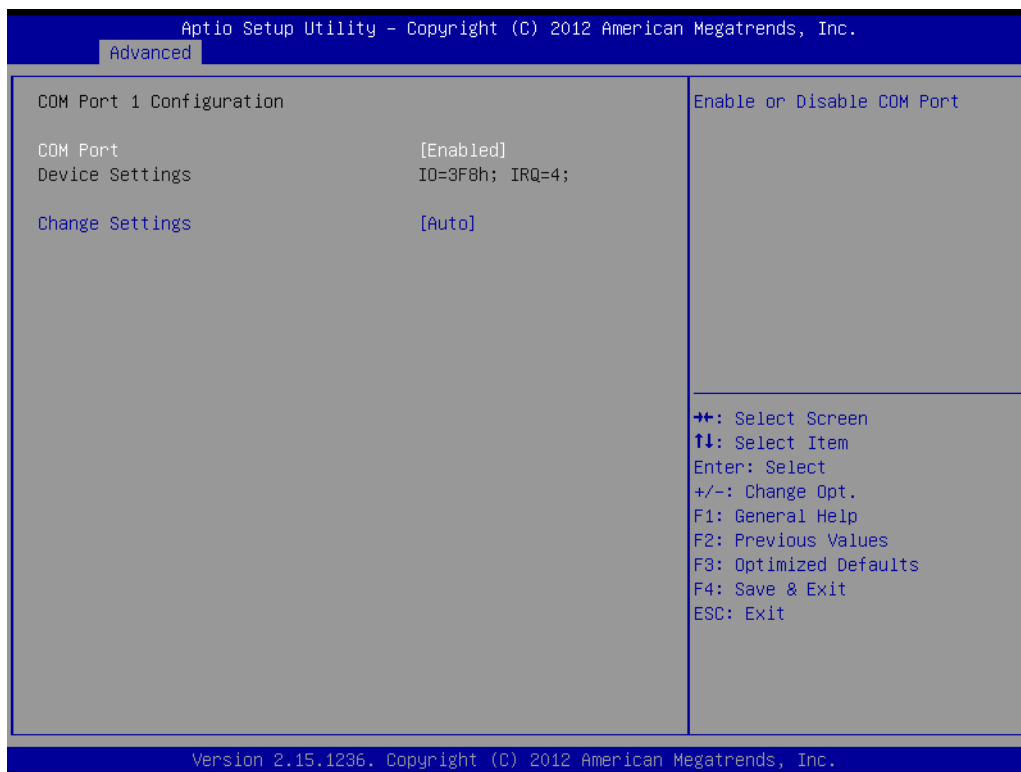

Figure 3.13 COM Port 1 Configuration

- **COM Port 1**
This item allows users to enable or disable the COM Port.
- **Change settings**
This item allows users to select an optimal setting for Super IO device.

■ COM Port 2 Configuration

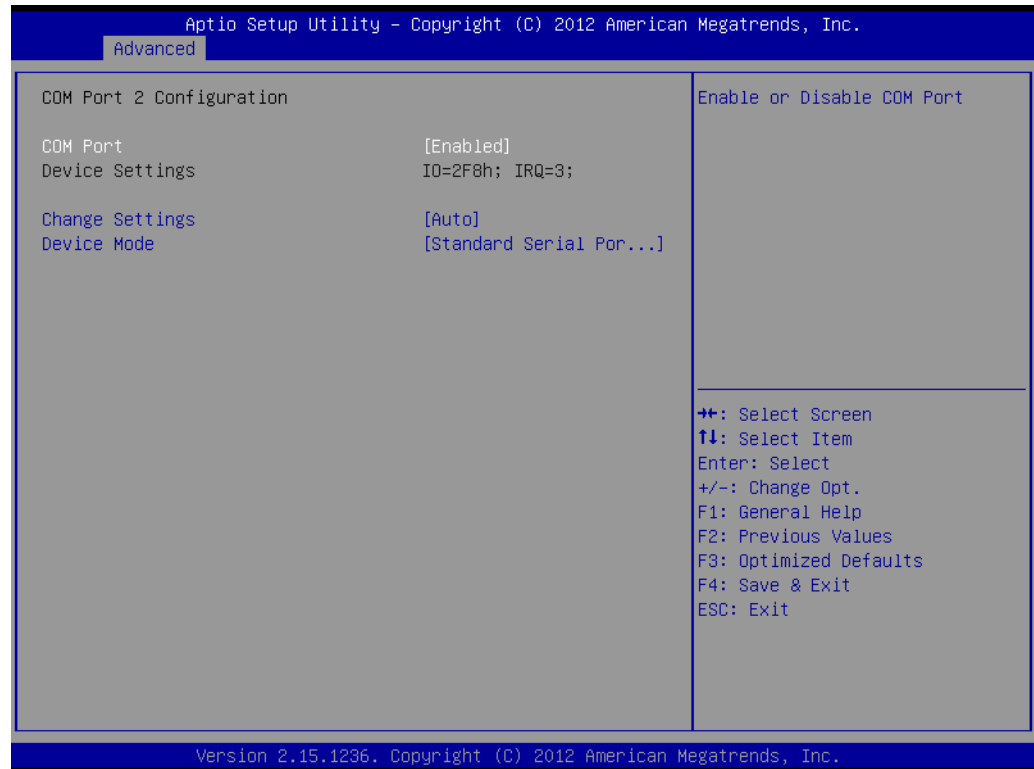

Figure 3.14 COM Port 2 Configuration

- **COM Port 2**
This item allows users to enable or disable the COM Port.
- **Change settings**
This item allows users to select an optimal setting for the Super IO device.
- **Device Mode**
This item allows users to change the Serial Port mode.
Select <High Speed> or <Normal Mode> mode.

■ Parallel Port Configuration

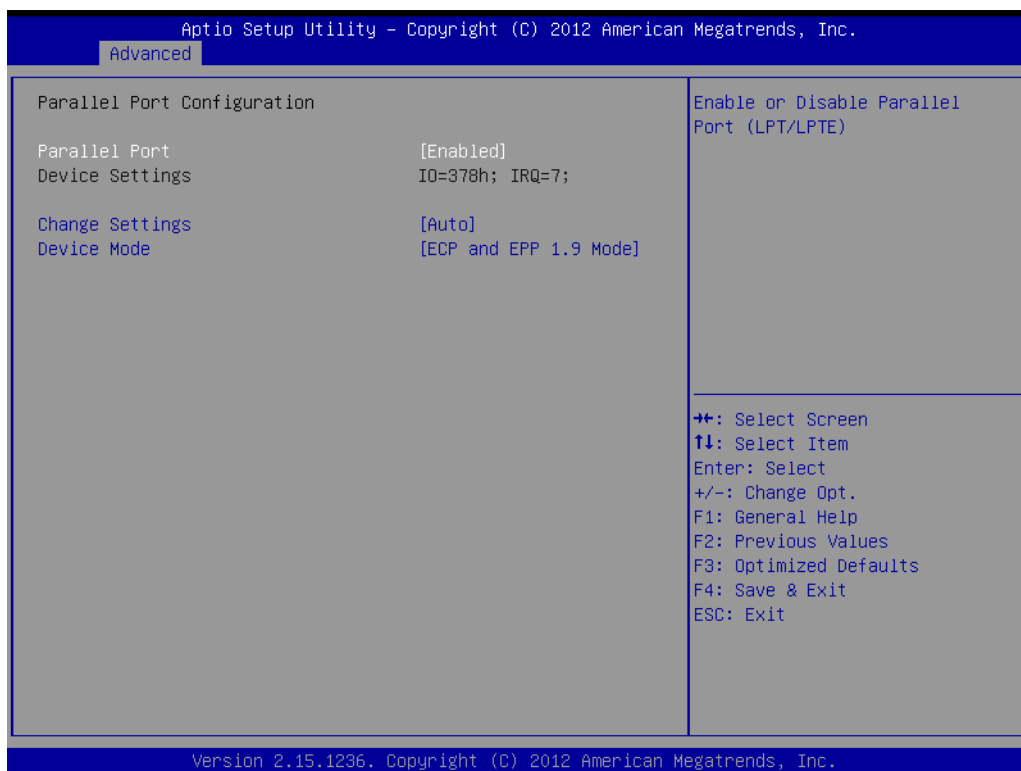

Figure 3.15 Parallel Port Configuration

- **Parallel Port**
This item allows users to enable or disable Parallel Port (LPT/LPTE).
- **Change settings**
This item allows users to select an optimal setting for the Super IO device.
- **Device Mode**
This item allows users to change the Printer Port mode.

■ **Hardware Monitor**

This item monitors hardware status.

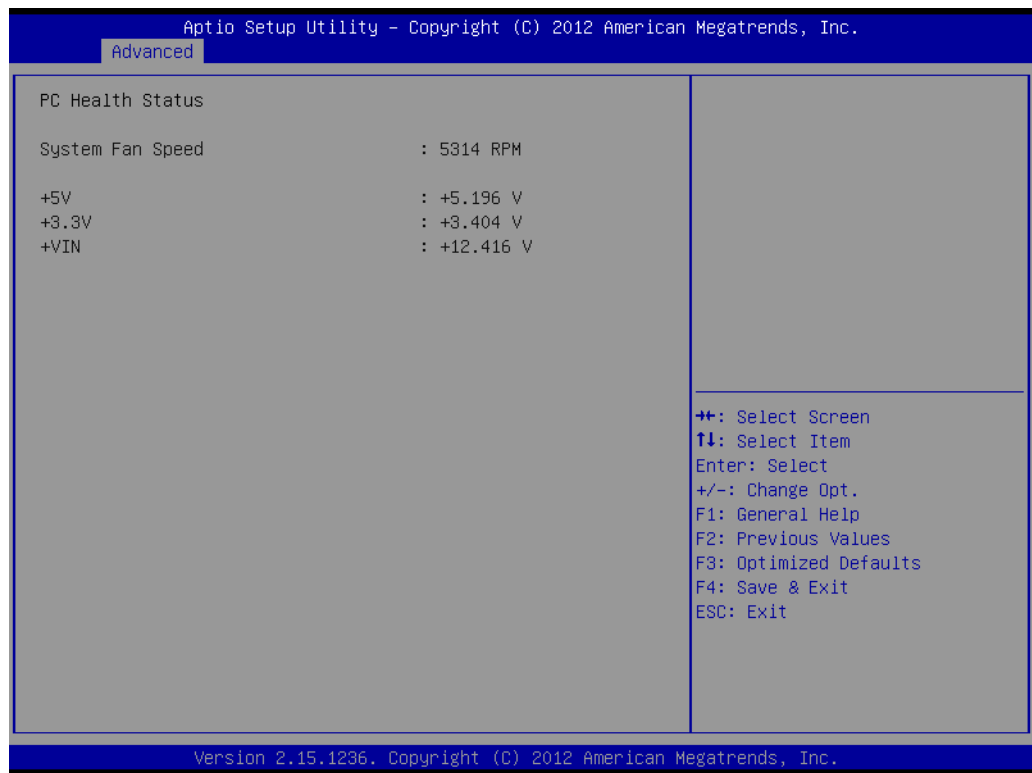

Figure 3.16 PC Hardware Monitor

3.2.2.9 iManager Configuration

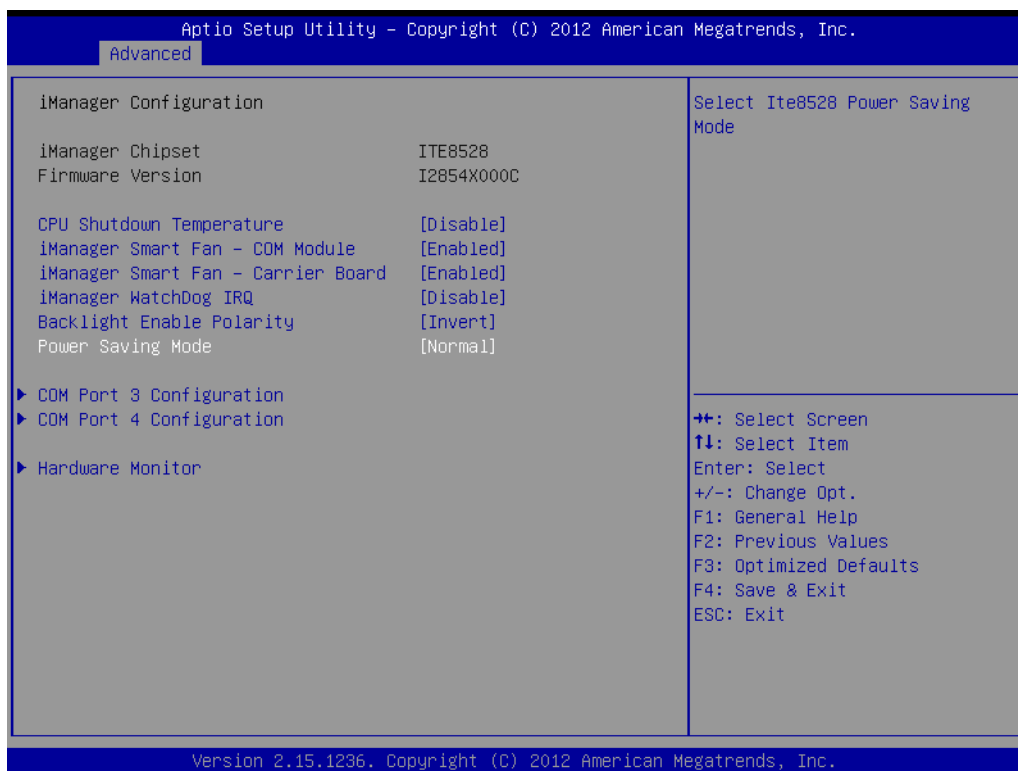

Figure 3.17 iManager Configuration

- **CPU Shutdown Temperature**
This item allows users to select CPU Shutdown Temperature.
- **iManager Smart Fan - COM Module**
This item allows users to enable or disable iManager Smart Fan - COM Module. To control iManager Smart FAN function.
- **iManager Smart Fan - Carrier Board**
This item allows users to enable or disable iManager Smart Fan - Carrier Board. To control iManager Smart FAN Carrier Board function.
- **iManager WatchDog IRQ**
This item allows users to select iManager IRQ number eBrain WatchDog.
- **Backlight Enable Polarity**
This item allows users to switch Backlight Enable Polarity for Native or Invert.
- **Power Saving Mode**
This item allows users to select ITE8528 Power Saving Mode.

■ COM Port 3 Configuration



Figure 3.18 COM 3 Configuration

- **COM Port 3**
This item allows users to enable or disable COM Port.
- **Change settings**
This item allows users to select an optimal setting for the Super IO device.
- **Device Mode**
This item allows users to change the Serial Port mode. Select <High Speed> or <Normal mode> mode.

■ COM Port 4 Configuration

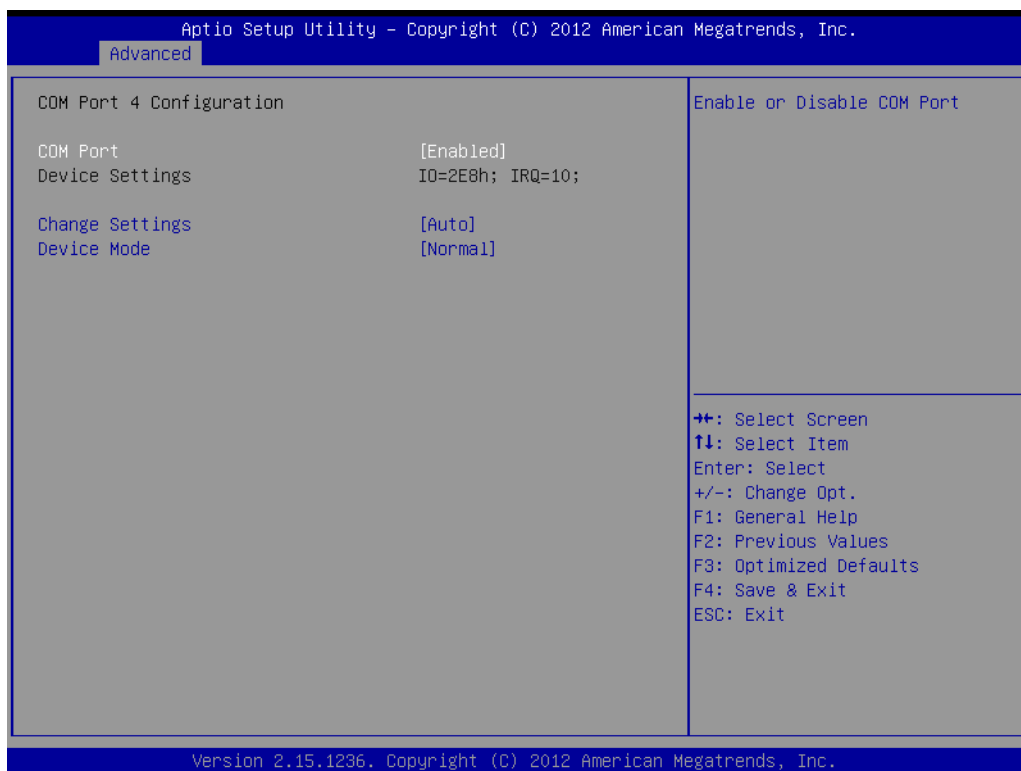

Figure 3.19 COM Port 4 Configuration

- **COM Port 4**
This item allows users to enable or disable a COM Port.
- **Change settings**
This item allows users to select an optimal setting for the Super IO device.
- **Device Mode**
This item allows users to change the Serial Port mode. Select <High Speed> or <Normal mode> mode.

■ **Hardware Monitor**

This item monitor hardware status.

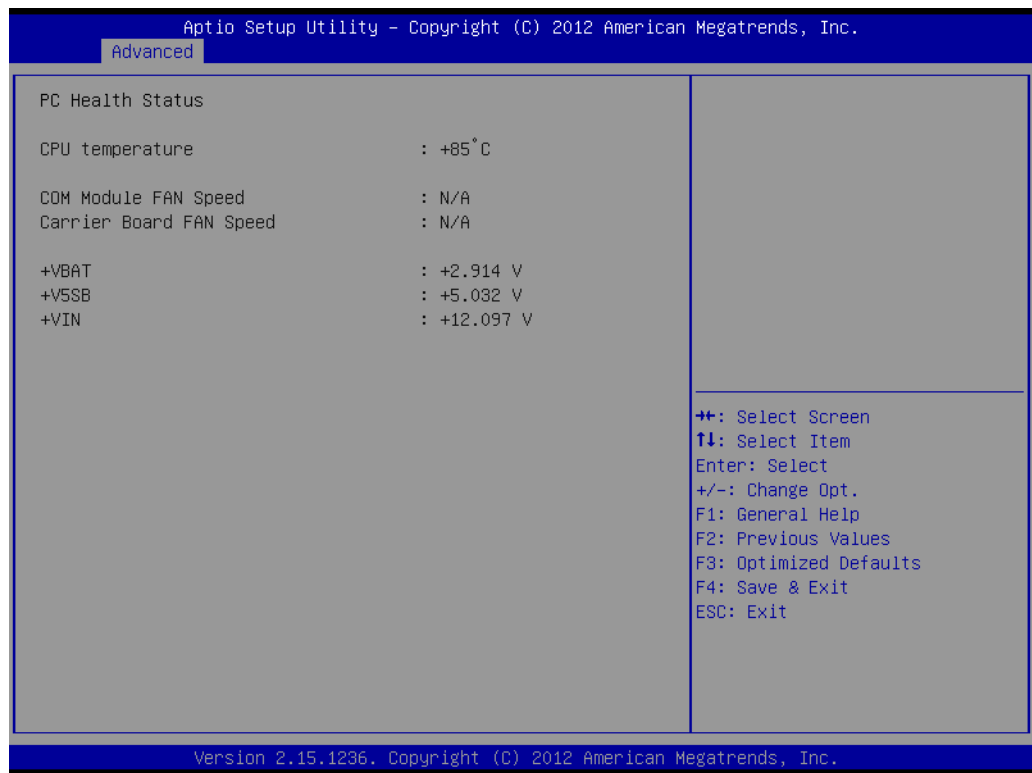

Figure 3.20 Hardware Monitor

3.2.2.10 Serial Port Console Redirection

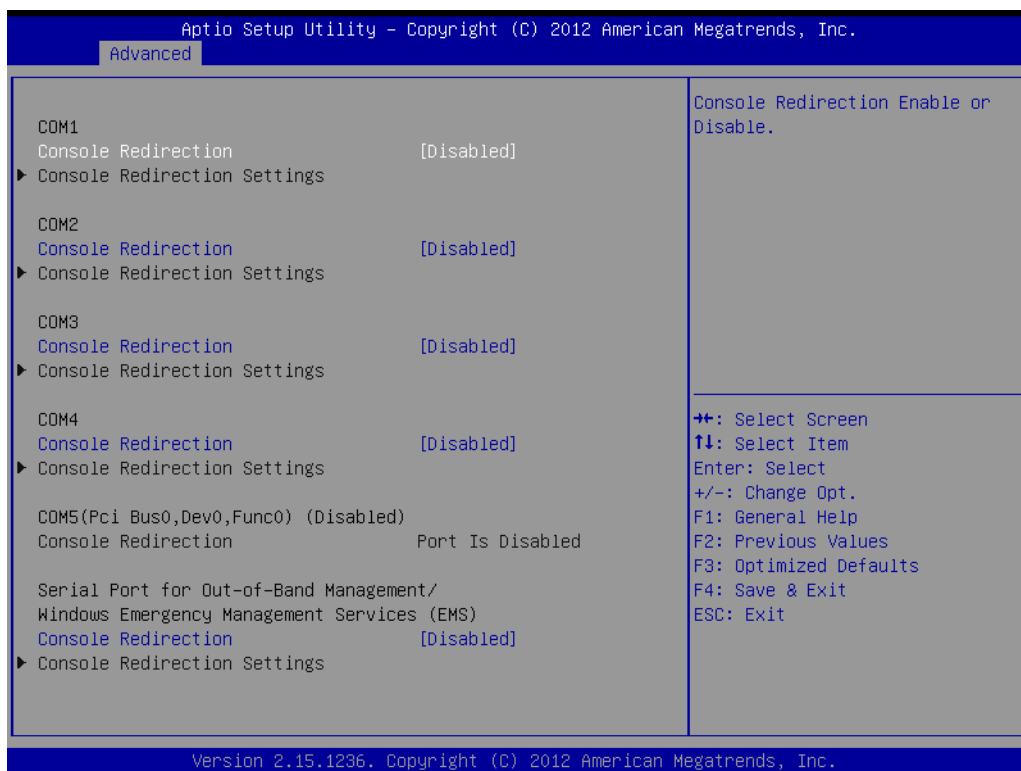

Figure 3.21 Serial Port Console Redirection

- **COM1 Console Redirection**
This item allows users to enable or disable Console Redirection.
- **COM2 Console Redirection**
This item allows users to enable or disable Console Redirection.
- **COM3 Console Redirection**
This item allows users to enable or disable Console Redirection.
- **COM4 Console Redirection**
This item allows users to enable or disable Console Redirection.
- **EMS Console Redirection**
This item allows users to enable or disable Console Redirection.

3.2.3 Chipset

Select the Chipset tab from the SOM-6894 setup screen to enter the Chipset BIOS Setup screen. You can display a Chipset BIOS Setup option by highlighting it using the <Arrow> keys. All Plug and Play BIOS Setup options are described in this section. The Plug and Play BIOS Setup screen is shown below.

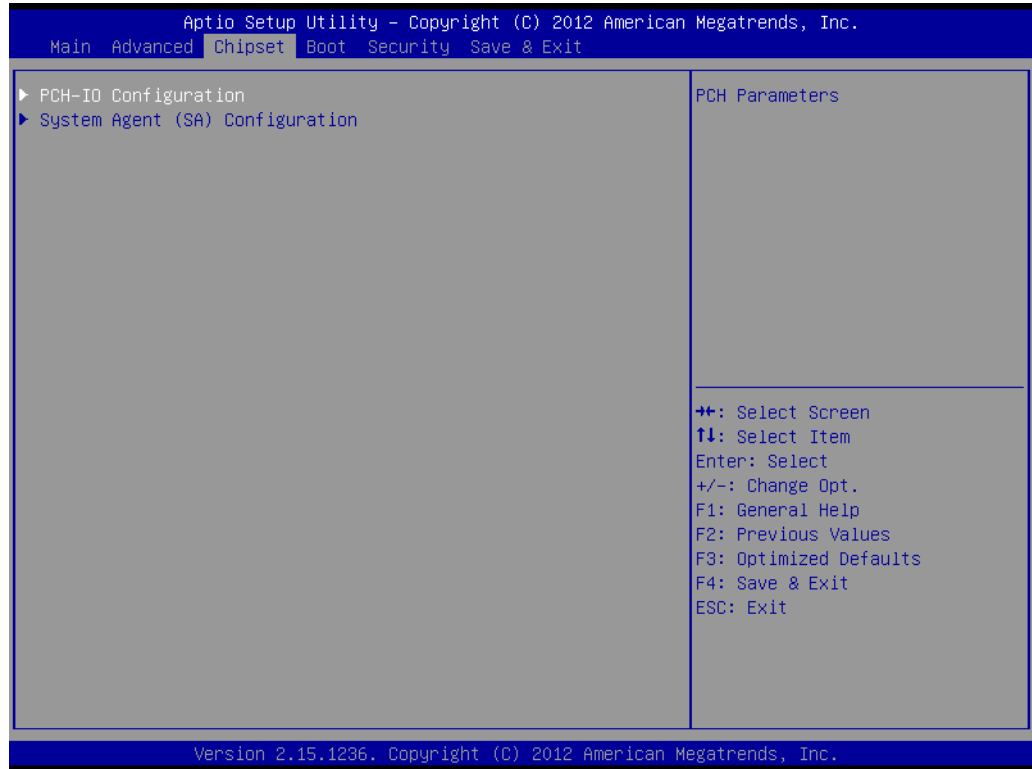

Figure 3.22 Chipset Setup

- **PCH-IO Configuration**
This item allows users to change PCH Parameters.
- **System Agent (SA) Configuration**
This item allows users to change System Agent (SA) Parameters.

3.2.3.1 PCH-IO Configuration



Figure 3.23 PCH-IO Configuration

- **PCI Express Configuration**
This item allows users to change PCI Express Configuration settings.
- **USB Configuration**
This item allows users to change USB Configuration settings.
- **PCH Azalia Configuration**
This item allows users to change PCH Azalia Configuration settings.
- **PCH LAN Controller**
This item allows users to enable or disable onboard NIC.
- **Wake on LAN**
This item allows users to enable or disable integrated LAN to wake the system. (The Wake on LAN cannot be disabled if ME is no at Sx State)
- **SLP_LAN# Low on DC Power**
This item allows users to enable or disable SLP_LAN# Low on DC Power.
- **GP27 Wake From DeepSx**
This item allows users to enable or disable GP27 Wake From DeepSx. Wake from DeepSx by the assertion of GP27 pin.
- **PCIE Wake From DeepSx**
This item allows users to enable or disable PCIE Wake From DeepSx. Wake from DeepSx by the assertion of PCIE.
- **SLP_S4 Assertion Width**
This item allows users to select a minimum assertion width of the SLP_S4# signal.
- **Restore AC Power Loss**

This item allows users to select AC power state when power is re-applied after a power failure.

■ PCI Express Configuration

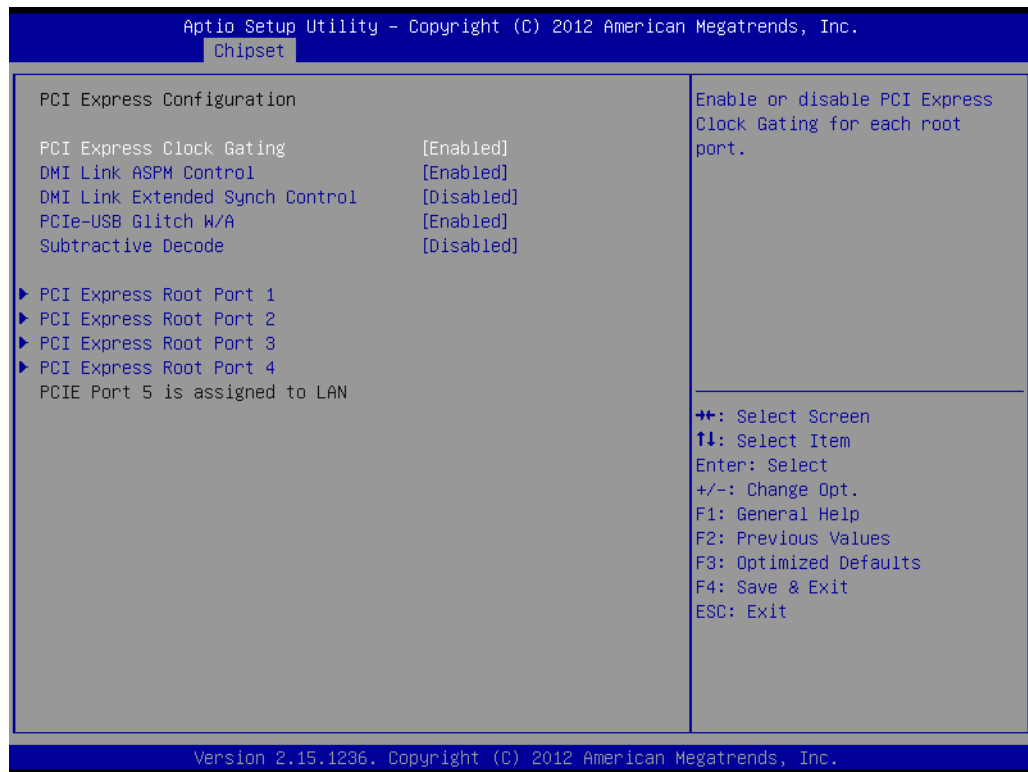

Figure 3.24 PCI Express Configuration

- **PCI Express Clock Gating**
This item allows users to enable or disable PCI Express Clock Gating for each root port.
- **DMI Link ASPM Control**
This item allows users to enable or disable DMI Link ASPM Control.
The Control of Active State Power Management on both NB side and SB side of the DMI Link.
- **DMI Link Extended Synch Control**
This item allows users to enable or disable DMI Link Extended Synch Control.
The Control of Extended Synch on SB side of the DMI Link.
- **PCIe-USB Glitch W/A**
This item allows users to enable or disable PCIe-USB Glitch W/A.
PCIe-USB Glitch W/A for bad USB device(s) connected behind PCIE/PEG Port.
- **Subtractive Decode**
This item allows users to enable or disable Subtractive Decode.
- **PCI Express Root Port 1**
This item allows users to change PCI Express Root Port 1 settings.
- **PCI Express Root Port 2**
This item allows users to change PCI Express Root Port 2 settings.

- **PCI Express Root Port 3**
This item allows users to change PCI Express Root Port 3 settings.
- **PCI Express Root Port 4**
This item allows users to change PCI Express Root Port 4 settings.
- **PCI Express Root Port 1 Configuration**

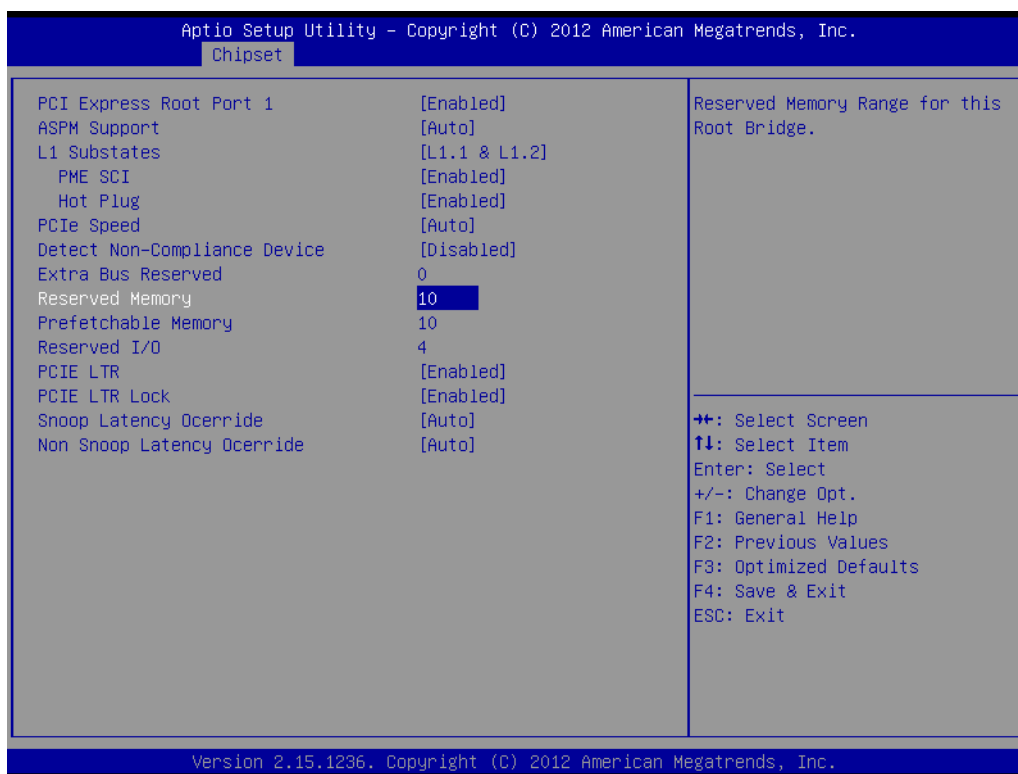

Figure 3.25 PCI Express Root Port 1 Configuration

PCI Express Root Port 1

This item allows users to enable or disable PCI Express Root Port.

ASPM Support

This item allows users to set the ASPM level.

Force L0s- Force all links to L0s state.

Auto-BIOS auto configure

Disable- disables ASPM

L1 Substates

This item allows users to change L1 Substates settings.

PME SCI

This item allows users to enable or disable PME SCI.

Hot Plug

This item allows users to enable or disable Hot Plug.

PCIe Speed

This item allows users to select PCIe Speed.

Detect Non-Compliance Device

This item allows users to enable or disable Detect Non-Compliance Device.

If enabled, it will take more time at POST time.

Extra Bus Reserved

This item allows users to select Extra Bus Reserved (0~7) for bridges behind this root bridge.

Reserved Memory

This item allows users to select Reserved Memory range for this root bridge.

Prefetchable Memory

This item allows users to select Prefetchable Memory range for this root bridge.

Reserved I/O

This item allows users to select Reserved I/O (4k/8k/12k/16k.../48k) range for this root bridge.

PCIE LTR

This item allows users to enable or disable PCIE LTR.

PCIE LTR Lock

This item allows users to enable or disable PCIE LTR Configuration Lock.

Snoop Latency Ocerride

This item allows users to select Snoop Latency Ocerride for PCH PCIE.

Non Snoop Latency Ocerride

This item allows users to select Non Snoop Latency Ocerride for PCH PCIE.

– PCI Express Root Port 2 Configuration

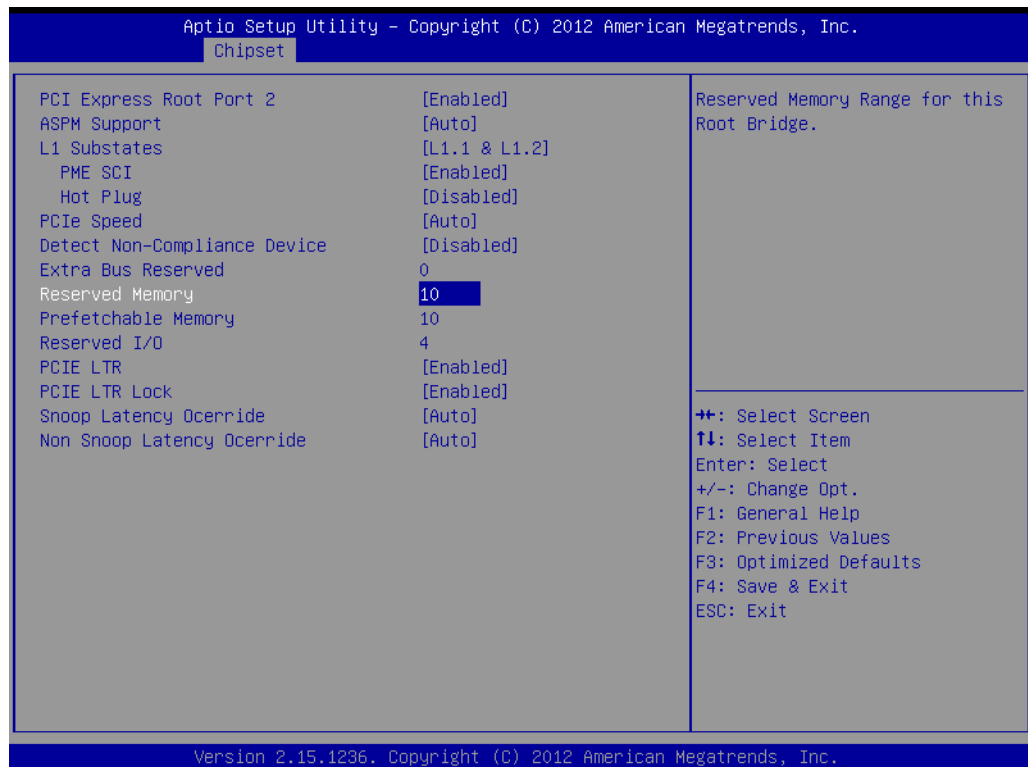

Figure 3.26 PCI Express Root Port 2 Configuration

PCI Express Root Port 2

This item allows users to enable or disable PCI Express Root Port.

ASPM Support

This item allows users to set the ASPM level.

Force L0s- Force all links to L0s state.

Auto-BIOS auto configure

Disable- disables ASPM

L1 Substates

This item allows users to change L1 Substates settings.

PME SCI

This item allows users to enable or disable PME SCI.

Hot Plug

This item allows users to enable or disable Hot Plug.

PCIe Speed

This item allows users to select PCIe Speed.

Detect Non-Compliance Device

This item allows users to enable or disable Detect Non-Compliance Device.

If enable, it will take more time at POST time.

Extra Bus Reserved

This item allows users to select Extra Bus Reserved (0~7) for bridges behind this root bridge.

Reserved Memory

This item allows users to select Reserved Memory range for this root bridge.

Prefetchable Memory

This item allows users to select Prefetchable Memory range for this root bridge.

Reserved I/O

This item allows users to select Reserved I/O (4k/8k/12k/16k.../48k) range for this root bridge.

PCIE LTR

This item allows users to enable or disable PCIE LTR.

PCIE LTR Lock

This item allows users to enable or disable PCIE LTR Configuration Lock.

Snoop Latency Ocerride

This item allows users to select Snoop Latency Ocerride for PCH PCIE.

Non Snoop Latency Ocerride

This item allows users to select Non Snoop Latency Ocerride for PCH PCIE.

– PCI Express Root Port 3 Configuration

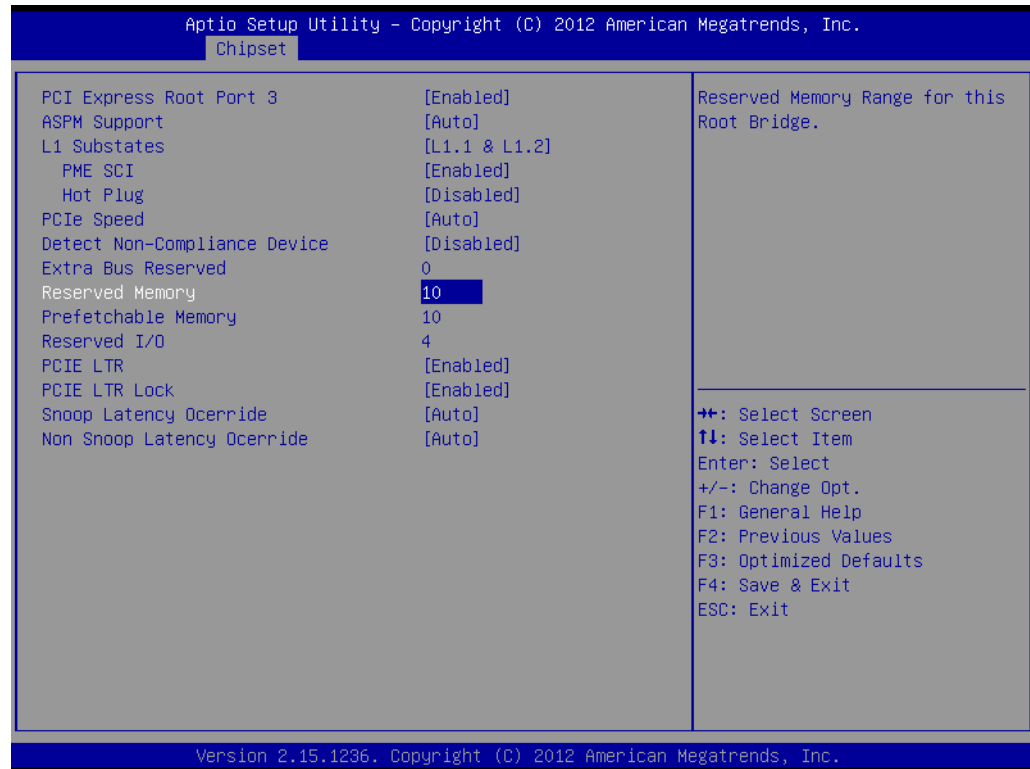

Figure 3.27 PCI Express Root Port 3 Configuration

PCI Express Root Port 3

This item allows users to enable or disable PCI Express Root Port.

ASPM Support

This item allows users to set the ASPM level.

Force L0s- Force all links to L0s state.

Auto-BIOS auto configure

Disable- disables ASPM

L1 Substates

This item allows users to change L1 Substates settings.

PME SCI

This item allows users to enable or disable PME SCI.

Hot Plug

This item allows users to enable or disable Hot Plug.

PCIe Speed

This item allows users to select PCIe Speed.

Detect Non-Compliance Device

This item allows users to enable or disable Detect Non-Compliance Device.

If enable, it will take more time at POST time.

Extra Bus Reserved

This item allows users to select Extra Bus Reserved (0~7) for bridges behind this root bridge.

Reserved Memory

This item allows users to select Reserved Memory range for this root bridge.

Prefetchable Memory

This item allows users to select Prefetchable Memory range for this root bridge.

Reserved I/O

This item allows users to select Reserved I/O (4k/8k/12k/16k.../48k) range for this root bridge.

PCIE LTR

This item allows users to enable or disable PCIE LTR.

PCIE LTR Lock

This item allows users to enable or disable PCIE LTR Configuration Lock.

Snoop Latency Ocerride

This item allows users to select Snoop Latency Ocerride for PCH PCIE.

Non Snoop Latency Ocerride

This item allows users to select Non Snoop Latency Ocerride for PCH PCIE.

– PCI Express Root Port 4 Configuration

Figure 3.28 PCI Express Root Port 4 Configuration

PCI Express Root Port 4

This item allows users to enable or disable PCI Express Root Port.

ASPM Support

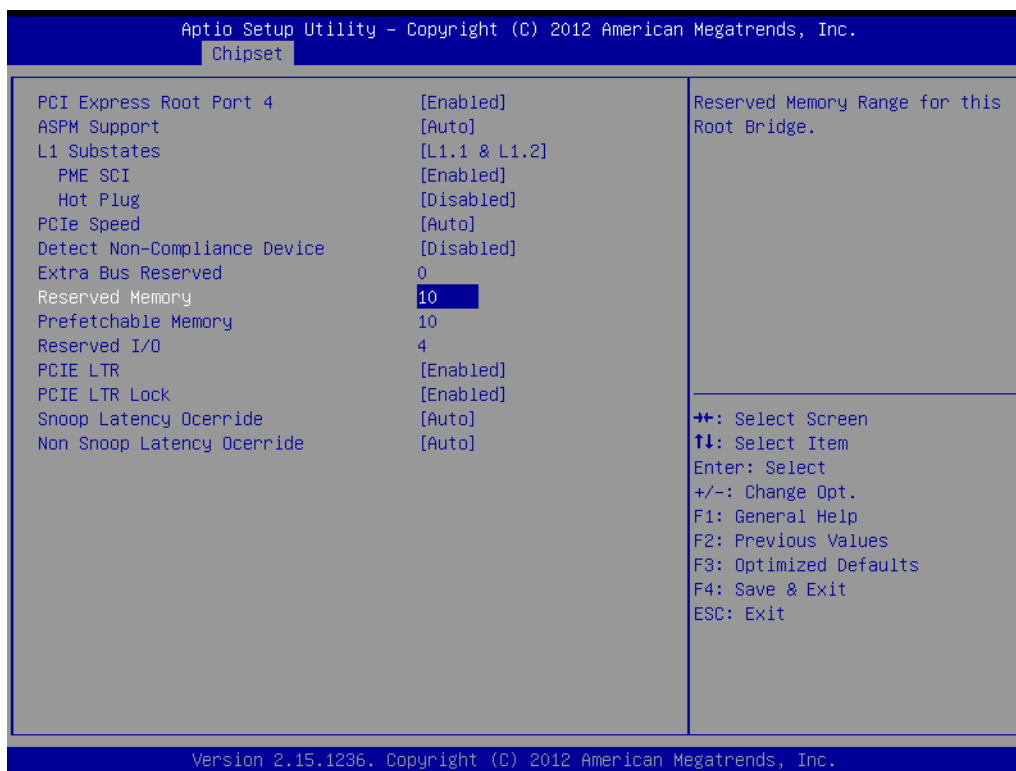
This item allows users to set the ASPM level.

Force L0s- Force all links to L0s state.

Auto-BIOS auto configure

Disable- disables ASPM

L1 Substates

This item allows users to change L1 Substates settings.

PME SCI

This item allows users to enable or disable PME SCI.

Hot Plug

This item allows users to enable or disable Hot Plug.

PCIe Speed

This item allows users to select PCIe Speed.

Detect Non-Compliance Device

This item allows users to enable or disable Detect Non-Compliance Device.

If enable, it will take more time at POST time.

Extra Bus Reserved

This item allows users to select Extra Bus Reserved (0~7) for bridges behind this root bridge.

Reserved Memory

This item allows users to select Reserved Memory range for this root bridge.

Prefetchable Memory

This item allows users to select Prefetchable Memory range for this root bridge.

Reserved I/O

This item allows users to select Reserved I/O (4k/8k/12k/16k.../48k) range for this root bridge.

PCIE LTR

This item allows users to enable or disable PCIE LTR.

PCIE LTR Lock

This item allows users to enable or disable PCIE LTR Configuration Lock.

Snoop Latency Ocerride

This item allows users to select Snoop Latency Ocerride for PCH PCIE.

Non Snoop Latency Ocerride

This item allows users to select Non Snoop Latency Ocerride for PCH PCIE.

■ USB Configuration

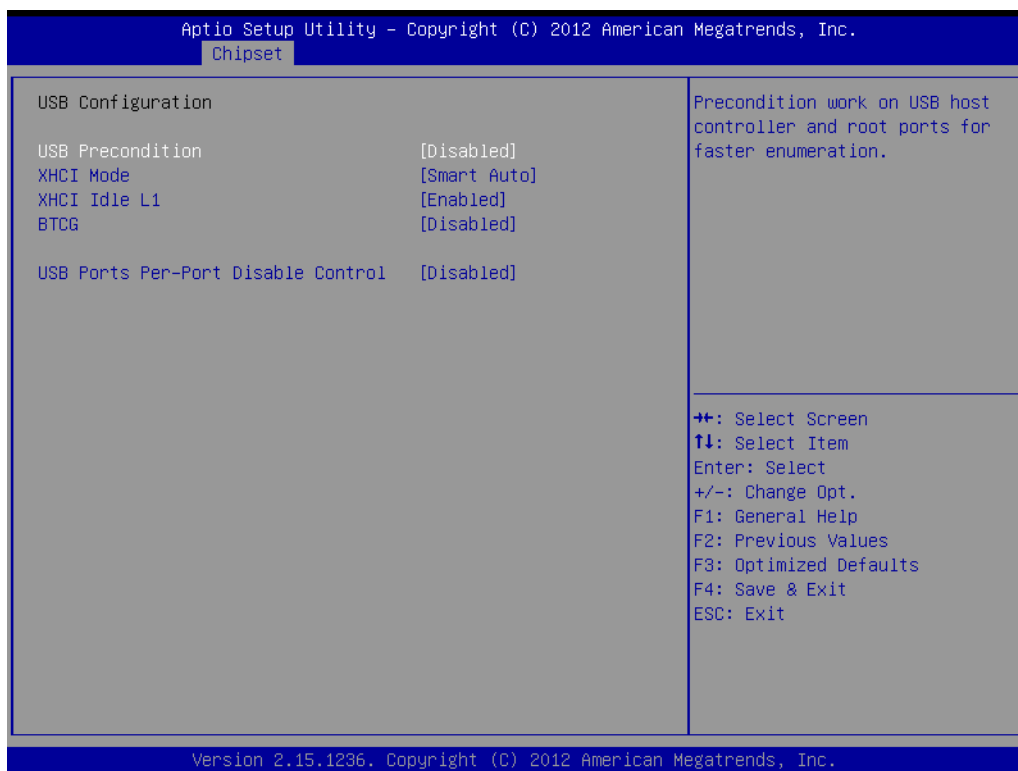

Figure 3.29 USB Configuration

- **USB Precondition**
This item allows users to enable or disable USB Precondition. Precondition work on USB host controller and root ports for faster enumeration.
- **XHCI Mode**
This item allows users to select mode of operation of XHCI mode.
- **XHCI Idle L1**
This item allows users to enable or disable XHCI Idle L1. XHCIIDLE L1 can be set to disable for LPT-LP Ax stepping to workaround USB3 hot plug will fail after 1 hot plug removal.
- **BTCG**
This item allows users to enable or disable trunk clock gating.
- **USB Ports Per-Port Disable Control**
This item allows users to enable or disable USB Ports Per-Port Disable Control. Control each of the USB ports (0~13) disabling

■ PCH Azalia Configuration

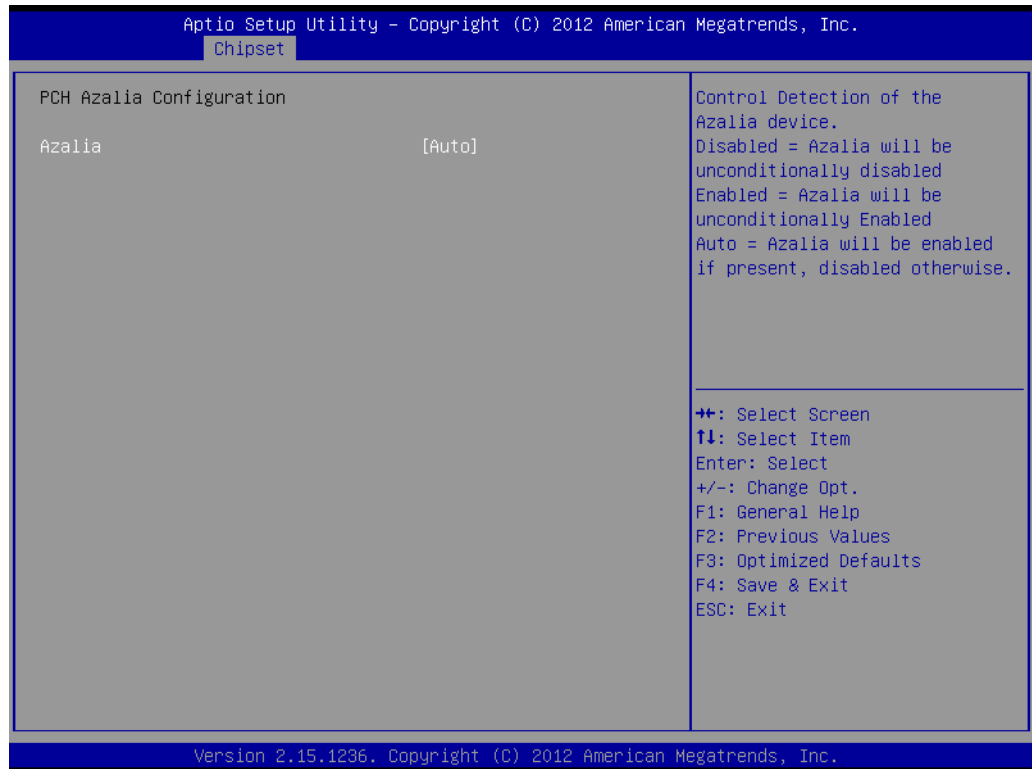

Figure 3.30 PCH Azalia Configuration

– Azalia

This item allows users to change Azalia settings.

Control detection of the Azalia device.

Disable- Azalia will be unconditionally Disabled

Enabled- Azalia will be unconditionally Enabled

Auto- Azalia will be enabled if present, disabled otherwise.

3.2.3.2 System Agent (SA) Configuration

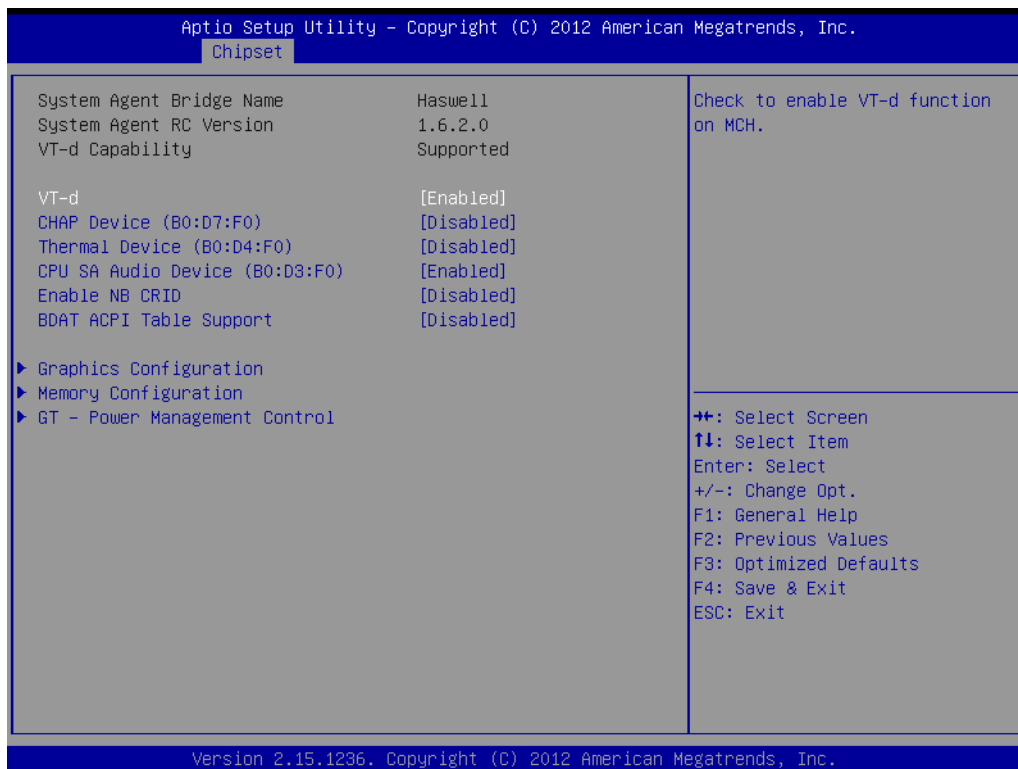

Figure 3.31 System Agent (SA) Configuration

- **VT-d**
This item allows users to enable or disable VT-d function.
- **CHAP Device (B0:D7:F0)**
This item allows users to enable or disable SA CHAP Device.
- **Thermal Device (B0:D4:F0)**
This item allows users to enable or disable SA Thermal Device.
- **CPU SA Audio Device (B0:D3:F0)**
This item allows users to enable or disable CPU SA Audio Device.
- **Enable NB CRID**
This item allows users to enable or disable Enable NB CRID workaround.
- **BDAT ACPI Table Support**
This item allows users to enable or disable the BDAT ACPI Table.
- **Graphics Configuration**
This item allows users to change graphics setting.
- **Memory Configuration**
This item allows users to change memory configuration parameters.
- **GT- Power Management Control**
This item allows users to change GT- Power Management Control Options.

■ Graphics Configuration

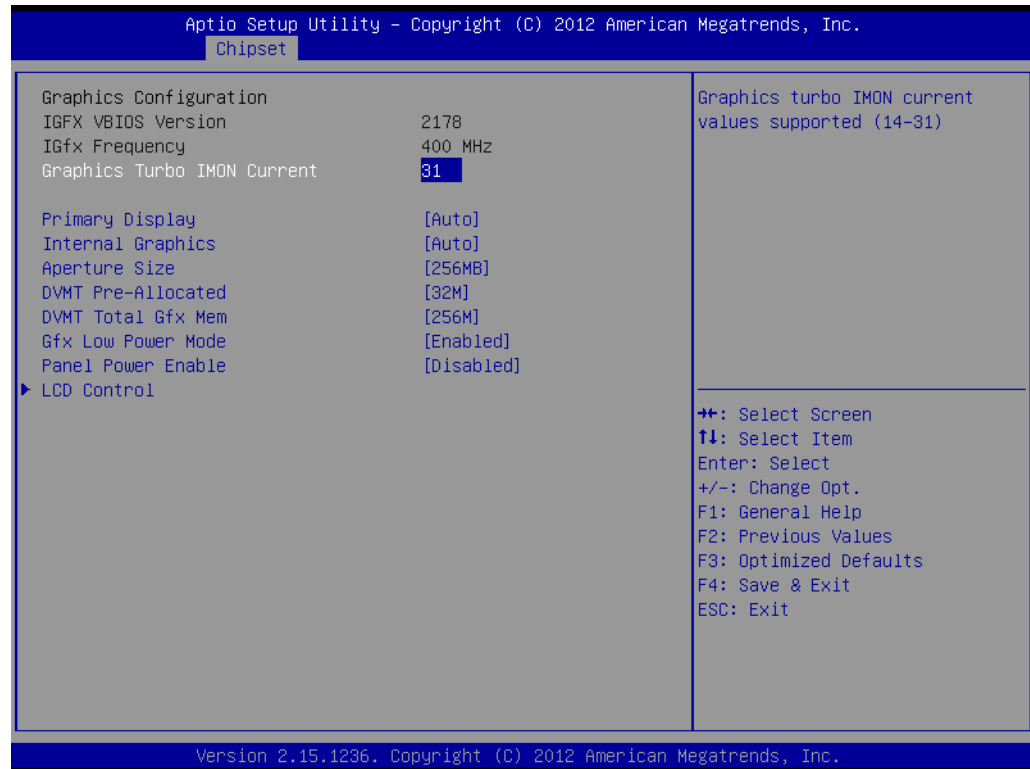

Figure 3.32 Graphics Configuration

- **Graphics Turbo IMON Current**
Shows graphics turbo IMON Current values supported (14-31)
- **Primary Display**
This item allows users to select which of IGFX/PEG/PCI Graphics device should be Primary display or select SG for Switchable Gfx.
- **Internal Graphics**
This item keeps IGD enabled based on the setup options.
- **Aperture Size**
This item allows users to change Aperture Size.
- **DVMT Pre-Allocated**
This item allows users to select DVMT 5.0 Pre-allocated (fixed) graphics memory size used by the internal graphics device.
- **DVMT Total Gfx Mem**
This item allows users to select DVMT 5.0 total graphic memory size used by the internal graphics device.
- **Gfx Low Power Mode**
This option is applicable for SFF only.
- **Panel Power Enable**
This item allows users to enable or disable forcing of Panel Power in the BIOS.
- **LCD Control**
This item allows users to do LCD control.

– LCD Control

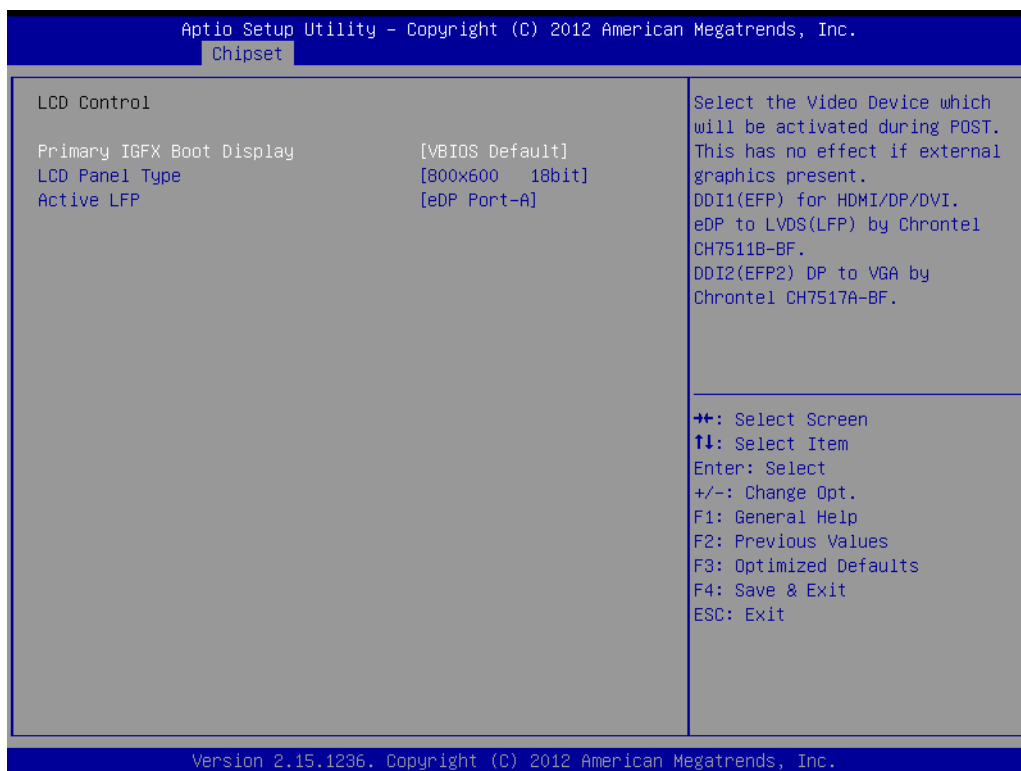

Figure 3.33 LCD Control

Primary IGFX Boot Display

This item allows users to select the Video Device which will be activated during post

This has no effect if external graphics present.

VGA: DDI2 (EFP2) DP to VGA by Chrontel CH7517A-BF

DDI1: DDI1 (EFP) for HDMI (Default)/DP/DVI

LVDS: eDP to LVDS(LFP) by Chrontel CH7511B-BF

LCD Panel Type

This item allows users to select LCD Panel used by Internal Graphics device by selecting the appropriate setup item.

Active LFP

This item allows users to select the Active LFP configuration.

– Memory Configuration

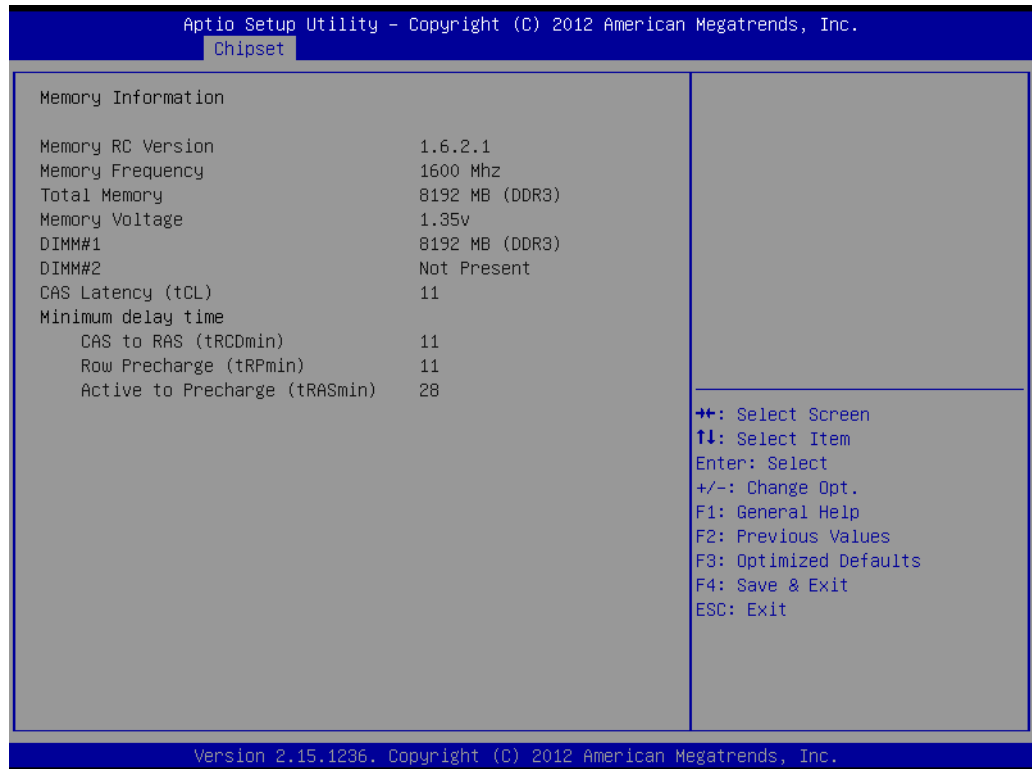

Figure 3.34 Memory Configuration

Memory Information

This item shows memory configuration parameters.

– GT- Power Management Control

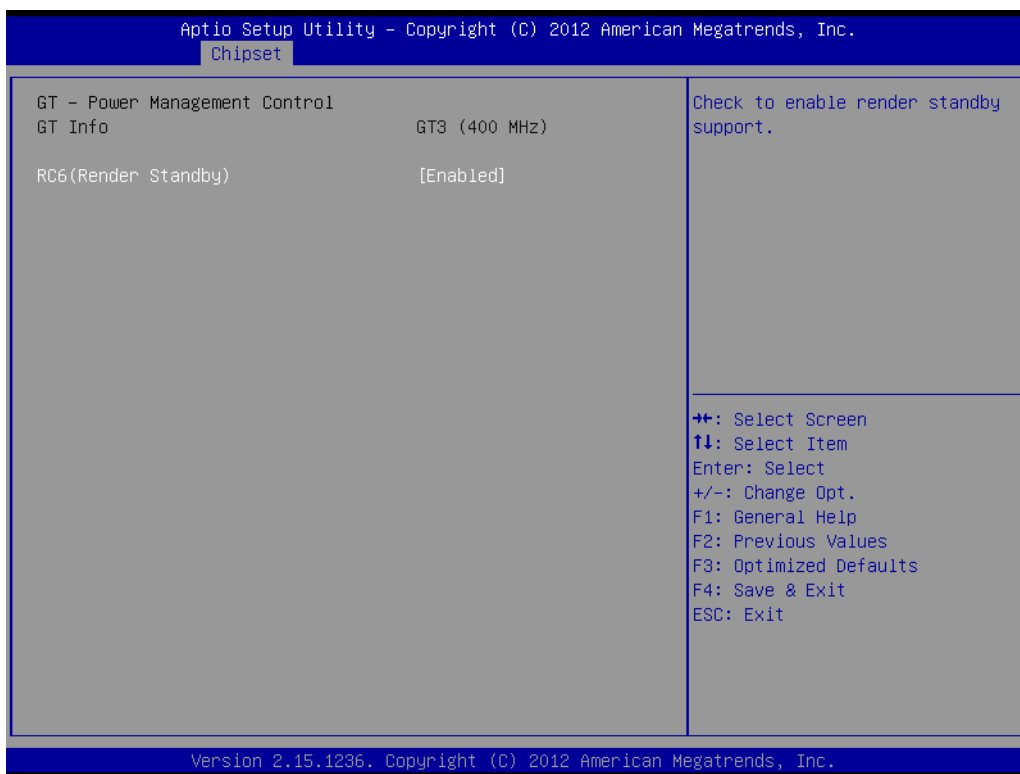

Figure 3.35 GT- Power Management Control

RC6 (Render Standby)

This item allows users to enable or disable RC6 (Render Standby) support.

3.2.4 Boot Settings

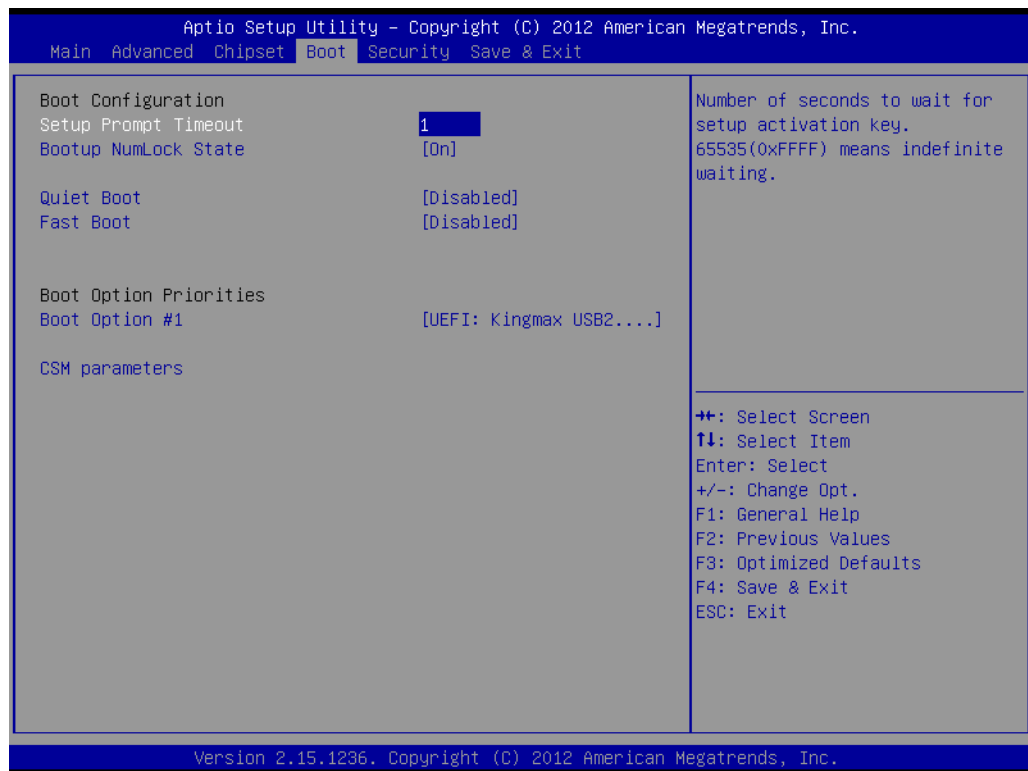

Figure 3.36 Boot Setup Utility

- **Setup Prompt Timeout**
This item allows users to select the number of seconds to wait for setup activation key.
- **Bootup NumLock State**
Select the keyboard NumLock state.
- **Quiet Boot**
This item allows users to enable or disable Quiet Boot option.
- **Fast Boot**
This item allows users to enable or disable boot with initialization of a minimal set of devices required to launch active boot option. It has no effect for BBS boot options.
- **Boot Option #1**
This item allows users to set the system boot order.
- **Hard Drive BBS Priorities**
This item allows users to set the order of the legacy devices in this group.
- **CSM parameters**
This item allows users to change CSM parameters setting.

3.2.4.1 CSM parameters

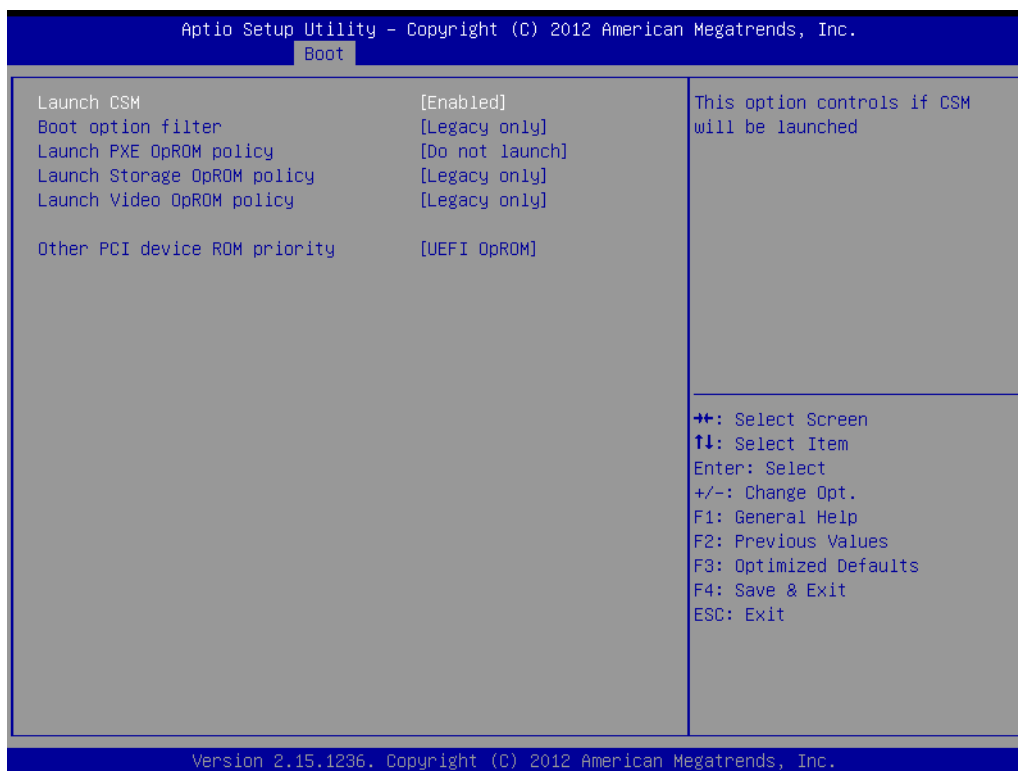

Figure 3.37 CSM parameters

- **Launch CSM**
This item allows users to enable or disable Launch CSM.
- **Boot option filter**
This item allows users to select Boot option filter setting.
- **Launch PXE OpROM policy**
This item allows users to select Launch PXE OpROM policy setting.
- **Launch Storage OpROM Policy**
This item allows users to select Launch Storage OpROM policy setting.
- **Launch Video OpROM policy**
This item allows users to select Launch Video OpROM policy setting.
- **Other PCI device ROM priority**
This item allows users to select Other PCI device ROM priority setting.

3.2.5 Security Setup

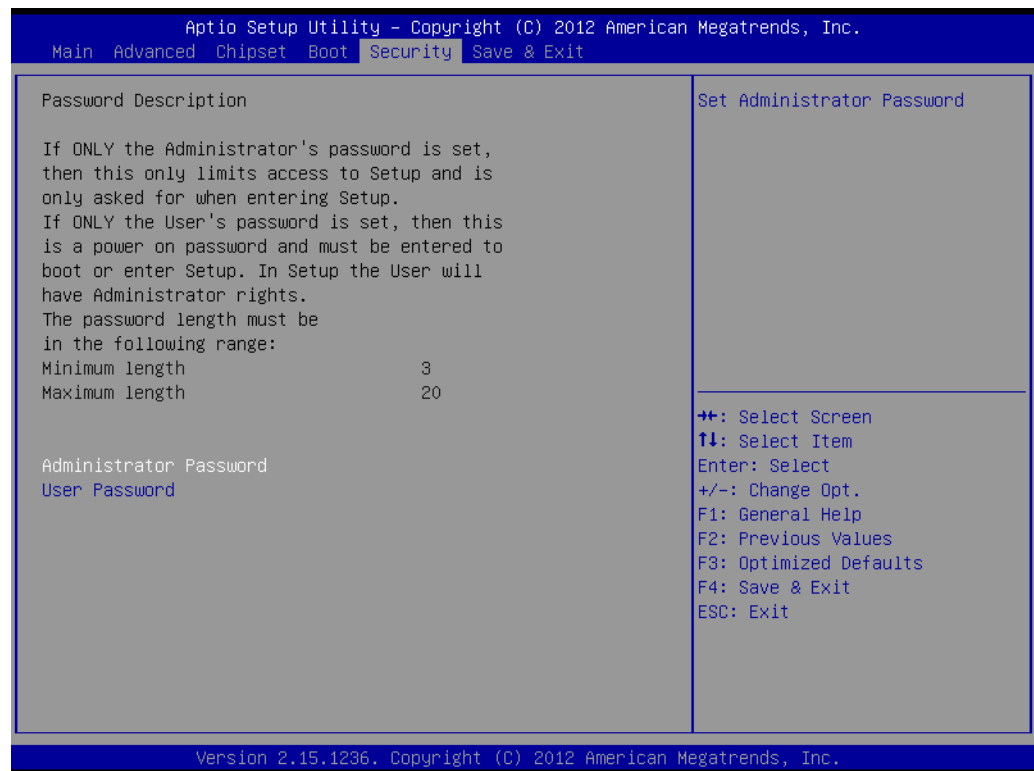

Figure 3.38 Security Setup

Select Security Setup from the SOM-6894Setup main BIOS setup menu. All Security Setup options, such as password protection is described in this section. To access the sub menu for the following items, select the item and press <Enter>:

Change Administrator / User Password: Select this option and press <ENTER> to access the sub menu, and then type in the password.

3.2.6 Save & Exit



Figure 3.39 Save & Exit

3.2.6.1 Save Changes and Exit

When users have completed system configuration, select this option to save changes, exit BIOS setup menu and reboot the computer if necessary to take effect all system configuration parameters.

3.2.6.2 Discard Changes and Exit

Select this option to quit Setup without making any permanent changes to the system configuration.

3.2.6.3 Save Changes and Reset

When users have completed system configuration, select this option to save changes, exit BIOS setup menu and reboot the computer to take effect all system configuration parameters.

3.2.6.4 Discard Changes and Reset

Select this option to quit Setup without making any permanent changes to the system configuration and reboot the computer.

3.2.6.5 Save Changes

When users have completed system configuration, select this option to save changes without exit BIOS setup menu.

3.2.6.6 Discard Changes

Select this option to discard any current changes and load previous system configuration.

3.2.6.7 Restore Defaults

The SOM-6894 automatically configures all setup items to optimal settings when users select this option. Optimal Defaults are designed for maximum system performance, but may not work best for all computer applications. In particular, do not use the Optimal Defaults if the user's computer is experiencing system configuration problems.

3.2.6.8 Save User Defaults

When users have completed system configuration, select this option to save changes as user defaults without exit BIOS setup menu.

3.2.6.9 Restore User Defaults

The users can select this option to restore user defaults.

3.2.6.10 Boot Override

This item allows users to choose boot device.

Chapter 4

S/W Introduction & Installation

Sections include:

- S/W Introduction
- Driver Installation
- Advantech iManager

4.1 S/W Introduction

The mission of Advantech Embedded Software Services is to "Enhance quality of life with Advantech platforms and Microsoft Windows embedded technology." We enable Windows Embedded software products on Advantech platforms to more effectively support the embedded computing community. Customers are freed from the hassle of dealing with multiple vendors (Hardware suppliers, System integrators, Embedded OS distributor) for projects. Our goal is to make Windows Embedded Software solutions easily and widely available to the embedded computing community.

4.2 Driver Installation

The Intel Chipset Software Installation (CSI) utility installs the Windows INF files that outline to the operating system how the chipset components will be configured.

4.2.1 Windows Driver Setup

To install the drivers on a windows-based OS, please connect to the internet and go to <http://support.advantech.com.tw> to download the drivers that you want to install and follow Driver Setup instructions to complete the installation.











4.2.2 Other OS

To install the drivers for Linux or other OS, please connect to the internet and go to <http://support.advantech.com.tw> to download the setup file.

4.3 Advantech iManager

Advantech's platforms come equipped with iManager, a micro controller that provides embedded features for system integrators. Embedded features have been moved from the OS/BIOS level to the board level, to increase reliability and simplify integration.

iManager runs whether the operating system is running or not; it can count the boot times and running hours of the device, monitor device health, and provide an advanced watchdog to handle errors as they happen. iManager also comes with a secure & encrypted EEPROM for storing important security keys or other customer information. All the embedded functions are configured through the API and provide corresponding utilities to demonstrate. These APIs comply with PICMG EAPI (Embedded Application Programmable Interface) specifications and makes these embedded features easier to integrate, speed development schedules, and provide customer's with software continuity while upgrading hardware. More details of how to use the APIs and utilities, please refer to the Advantech iManager 2.0 Software API User Manual.

<p>Control</p> <p> GPIO General Purpose Input/Output is a flexible parallel interface that allows a variety of custom connections. It allows users to monitor the level of signal input or set the output status to switch on/off a device. Our API also provides Programmable GPIO, which allows developers to dynamically set the GPIO input or output status.</p> <p> SMBus SMBus is the System Management Bus defined by Intel® Corporation in 1995. It is used in personal computers and servers for low-speed system management communications. The SMBus API allows a developer to interface a embedded system environment and transfer serial messages using the SMBus protocols, allowing multiple simultaneous device control.</p> <p> I2C I2C is a bi-directional two wire bus that was developed by Philips for use in their televisions in the 1980s. The I2C API allows a developer to interface with an embedded system environment and transfer serial messages using the I2C protocols, allowing multiple simultaneous device control.</p>	<p>Monitor</p> <p> Watchdog A watchdog timer (WDT) is a device that performs a specific operation after a certain period of time if something goes wrong and the system does not recover on its own. A watchdog timer can be programmed to perform a warm boot (restarting the system) after a certain number of seconds.</p> <p> Hardware Monitor The Hardware Monitor (HWM) API is a system health supervision API that inspects certain condition indexes, such as fan speed, temperature and voltage.</p> <p> Hardware Control The Hardware Control API allows developers to set the PWM (Pulse Width Modulation) value to adjust fan speed or other devices; it can also be used to adjust the LCD brightness.</p>
<p>Display</p> <p> Brightness Control The Brightness Control API allows a developer to interface with an embedded device to easily control brightness.</p> <p> Backlight The Backlight API allows a developer to control the backlight (screen) on/off in an embedded device.</p>	<p>Power Saving</p> <p> CPU Speed Make use of Intel SpeedStep technology to reduce power power consumption. The system will automatically adjust the CPU Speed depending on system loading.</p> <p> System Throttling Refers to a series of methods for reducing power consumption in computers by lowering the clock frequency. These APIs allow the user to lower the clock from 87.5% to 12.5%.</p>

Appendix **A**

Pin Assignment

This appendix gives you the information about the hardware pin assignment of the SOM-6894 CPU System on Module.

Sections include:

- SOM-6894 Type 6 Pin Assignment

A.1 SOM-6894 Type 6 Pin Assignment

This section gives SOM-6894 pin assignment on COM Express connector which compliant with COMR.0 R2.1 Type 6 pin-out definitions. More details about how to use these pins and get design reference, please contact to Advantech for design guide, checklist, reference schematic, and other hardware/software supports.

SOM-6894 Row A,B			
A1	GND (FIXED)	B1	GND (FIXED)
A2	GBE0_MDI3-	B2	GBE0_ACT#
A3	GBE0_MDI3+	B3	LPC_FRAME#
A4	GBE0_LINK100#	B4	LPC_AD0
A5	GBE0_LINK1000#	B5	LPC_AD1
A6	GBE0_MDI2-	B6	LPC_AD2
A7	GBE0_MDI2+	B7	LPC_AD3
A8	GBE0_LINK#	B8	N/A
A9	GBE0_MDI1-	B9	N/A
A10	GBE0_MDI1+	B10	LPC_CLK
A11	GND (FIXED)	B11	GND (FIXED)
A12	GBE0_MDI0-	B12	PWRBTN#
A13	GBE0_MDI0+	B13	SMB_CK
A14	N/A	B14	SMB_DAT
A15	SUS_S3#	B15	SMB_ALERT#
A16	SATA0_TX+	B16	SATA1_TX+
A17	SATA0_TX-	B17	SATA1_TX-
A18	SUS_S4#	B18	SUS_STAT#
A19	SATA0_RX+	B19	SATA1_RX+
A20	SATA0_RX-	B20	SATA1_RX-
A21	GND (FIXED)	B21	GND (FIXED)
A22	SATA2_TX+	B22	SATA3_TX+
A23	SATA2_TX-	B23	SATA3_TX-
A24	SUS_S5#	B24	PWR_OK
A25	SATA2_RX+	B25	SATA3_RX+
A26	SATA2_RX-	B26	SATA3_RX-
A27	BATLOW#	B27	WDT
A28	(S)ATA_ACT#	B28	AC/HDA_SDIN2
A29	AC/HDA_SYNC	B29	AC/HDA_SDIN1
A30	AC/HDA_RST#	B30	AC/HDA_SDIN0
A31	GND (FIXED)	B31	GND (FIXED)
A32	AC/HDA_BITCLK	B32	SPKR
A33	AC/HDA_SDOOUT	B33	I2C_CK
A34	BIOS_DIS0#	B34	I2C_DAT
A35	THRMTRIP#	B35	THRM#
A36	USB6-	B36	USB7-
A37	USB6+	B37	USB7+
A38	USB_6_7_OC#	B38	USB_4_5_OC#
A39	USB4-	B39	USB5-
A40	USB4+	B40	USB5+

A41	GND (FIXED)	B41	GND (FIXED)
A42	USB2-	B42	USB3-
A43	USB2+	B43	USB3+
A44	USB_2_3_OC#	B44	USB_0_1_OC#
A45	USB0-	B45	USB1-
A46	USB0+	B46	USB1+
A47	VCC_RTC	B47	EXCD1_PERST#
A48	EXCD0_PERST#	B48	EXCD1_CPPE#
A49	EXCD0_CPPE#	B49	SYS_RESET#
A50	LPC_SERIRQ	B50	CB_RESET#
A51	GND (FIXED)	B51	GND (FIXED)
A52	PCIE_TX5+	B52	PCIE_RX5+
A53	PCIE_TX5-	B53	PCIE_RX5-
A54	GPI0	B54	GPO1
A55	PCIE_TX4+	B55	PCIE_RX4+
A56	PCIE_TX4-	B56	PCIE_RX4-
A57	GND	B57	GPO2
A58	PCIE_TX3+	B58	PCIE_RX3+
A59	PCIE_TX3-	B59	PCIE_RX3-
A60	GND (FIXED)	B60	GND (FIXED)
A61	PCIE_TX2+	B61	PCIE_RX2+
A62	PCIE_TX2-	B62	PCIE_RX2-
A63	GPI1	B63	GPO3
A64	PCIE_TX1+	B64	PCIE_RX1+
A65	PCIE_TX1-	B65	PCIE_RX1-
A66	GND	B66	WAKE0#
A67	GPI2	B67	WAKE1#
A68	PCIE_TX0+	B68	PCIE_RX0+
A69	PCIE_TX0-	B69	PCIE_RX0-
A70	GND (FIXED)	B70	GND (FIXED)
A71	LVDS_A0+	B71	LVDS_B0+
A72	LVDS_A0-	B72	LVDS_B0-
A73	LVDS_A1+	B73	LVDS_B1+
A74	LVDS_A1-	B74	LVDS_B1-
A75	LVDS_A2+	B75	LVDS_B2+
A76	LVDS_A2-	B76	LVDS_B2-
A77	LVDS_VDD_EN	B77	LVDS_B3+
A78	LVDS_A3+	B78	LVDS_B3-
A79	LVDS_A3-	B79	LVDS_BKLT_EN
A80	GND (FIXED)	B80	GND (FIXED)
A81	LVDS_A_CK+	B81	LVDS_B_CK+
A82	LVDS_A_CK-	B82	LVDS_B_CK-
A83	LVDS_I2C_CK	B83	LVDS_BKLT_CTRL
A84	LVDS_I2C_DAT	B84	VCC_5V_SBY
A85	GPI3	B85	VCC_5V_SBY
A86	RSVD(KBD_RST# if R472 stuffed)	B86	VCC_5V_SBY
A87	eDP_HPD	B87	VCC_5V_SBY

A88	PCIE_CLK_REF+	B88	BIOS_DIS1#
A89	PCIE_CLK_REF-	B89	VGA_RED
A90	GND (FIXED)	B90	GND (FIXED)
A91	SPI_POWER	B91	VGA_GRN
A92	SPI_MISO	B92	VGA_BLU
A93	GPO0	B93	VGA_HSYNC
A94	SPI_CLK	B94	VGA_VSYNC
A95	SPI_MOSI	B95	VGA_I2C_CK
A96	N/A	B96	VGA_I2C_DAT
A97	TYPE10#	B97	SPI_CS#
A98	SER0_TX	B98	RSVD
A99	SER0_RX	B99	RSVD
A100	GND (FIXED)	B100	GND (FIXED)
A101	SER1_TX	B101	FAN_PWMOUT
A102	SER1_RX	B102	FAN_TACHIN
A103	LID#	B103	SLEEP#
A104	VCC_12V	B104	VCC_12V
A105	VCC_12V	B105	VCC_12V
A106	VCC_12V	B106	VCC_12V
A107	VCC_12V	B107	VCC_12V
A108	VCC_12V	B108	VCC_12V
A109	VCC_12V	B109	VCC_12V
A110	GND (FIXED)	B110	GND (FIXED)

SOM-6894 Row C,D

C1	GND (FIXED)	D1	GND (FIXED)
C2	GND	D2	GND
C3	USB_SSRX0-	D3	USB_SSTX0-
C4	USB_SSRX0+	D4	USB_SSTX0+
C5	GND	D5	GND
C6	USB_SSRX1-	D6	USB_SSTX1-
C7	USB_SSRX1+	D7	USB_SSTX1+
C8	GND	D8	GND
C9	USB_SSRX2- (BOM Option)	D9	USB_SSTX2- (BOM Option)
C10	USB_SSRX2+ (BOM Option)	D10	USB_SSTX2+ (BOM Option)
C11	GND (FIXED)	D11	GND (FIXED)
C12	USB_SSRX3- (BOM Option)	D12	USB_SSTX3- (BOM Option)
C13	USB_SSRX3+ (BOM Option)	D13	USB_SSTX3+ (BOM Option)
C14	GND	D14	GND
C15	N/A	D15	DDI1_CTRLCLK_AUX+
C16	N/A	D16	DDI1_CTRLDATA_AUX-
C17	RSVD	D17	RSVD
C18	RSVD	D18	RSVD
C19	PCIE_RX6+	D19	PCIE_TX6+
C20	PCIE_RX6-	D20	PCIE_TX6-
C21	GND (FIXED)	D21	GND (FIXED)
C22	PCIE_TX7+	D22	PCIE_TX7+
C23	PCIE_RX7-	D23	PCIE_TX7-

C24	DDI1_HPDP	D24	RSVD
C25	N/A	D25	RSVD
C26	N/A	D26	DDI1_PAIR0+
C27	RSVD	D27	DDI1_PAIR0-
C28	RSVD	D28	RSVD
C29	N/A	D29	DDI1_PAIR1+
C30	N/A	D30	DDI1_PAIR1-
C31	GND (FIXED)	D31	GND (FIXED)
C32	DDI2_CTRLCLK_AUX+ (BOM Option)	D32	DDI1_PAIR2+
C33	DDI2_CTRLDATA_AUX- (BOM Option)	D33	DDI1_PAIR2-
C34	DDI2_DDC_AUX_SEL (BOM Option)	D34	DDI1_DDC_AUX_SEL
C35	RSVD	D35	RSVD
C36	N/A	D36	DDI1_PAIR3+
C37	N/A	D37	DDI1_PAIR3-
C38	N/A	D38	RSVD
C39	N/A	D39	DDI2_PAIR0+ (BOM Option)
C40	N/A	D40	DDI2_PAIR0- (BOM Option)
C41	GND (FIXED)	D41	GND (FIXED)
C42	N/A	D42	DDI2_PAIR1+ (BOM Option)
C43	N/A	D43	DDI2_PAIR1- (BOM Option)
C44	N/A	D44	DDI2_HPDP
C45	RSVD	D45	RSVD
C46	N/A	D46	DDI2_PAIR2+ (BOM Option)
C47	N/A	D47	DDI2_PAIR2- (BOM Option)
C48	RSVD	D48	RSVD
C49	N/A	D49	DDI2_PAIR3+ (BOM Option)
C50	N/A	D50	DDI2_PAIR3- (BOM Option)
C51	GND (FIXED)	D51	GND (FIXED)
C52	N/A	D52	N/A
C53	N/A	D53	N/A
C54	N/A	D54	N/A
C55	N/A	D55	N/A
C56	N/A	D56	N/A
C57	N/A	D57	N/A
C58	N/A	D58	N/A
C59	N/A	D59	N/A
C60	GND (FIXED)	D60	GND (FIXED)
C61	N/A	D61	N/A
C62	N/A	D62	N/A
C63	RSVD	D63	RSVD
C64	RSVD	D64	RSVD
C65	N/A	D65	N/A
C66	N/A	D66	N/A
C67	RSVD	D67	GND
C68	N/A	D68	N/A
C69	N/A	D69	N/A

C70	GND (FIXED)	D70	GND (FIXED)
C71	N/A	D71	N/A
C72	N/A	D72	N/A
C73	GND	D73	GND
C74	N/A	D74	N/A
C75	N/A	D75	N/A
C76	GND	D76	GND
C77	RSVD	D77	RSVD
C78	N/A	D78	N/A
C79	N/A	D79	N/A
C80	GND (FIXED)	D80	GND (FIXED)
C81	N/A	D81	N/A
C82	N/A	D82	N/A
C83	RSVD	D83	RSVD
C84	GND	D84	GND
C85	N/A	D85	N/A
C86	N/A	D86	N/A
C87	GND	D87	GND
C88	N/A	D88	N/A
C89	N/A	D89	N/A
C90	GND (FIXED)	D90	GND (FIXED)
C91	N/A	D91	N/A
C92	N/A	D92	N/A
C93	GND	D93	GND
C94	N/A	D94	N/A
C95	N/A	D95	N/A
C96	GND	D96	GND
C97	RSVD	D97	N/A
C98	N/A	D98	N/A
C99	N/A	D99	N/A
C100	GND (FIXED)	D100	GND (FIXED)
C101	N/A	D101	N/A
C102	N/A	D102	N/A
C103	GND	D103	GND
C104	VCC_12V	D104	VCC_12V
C105	VCC_12V	D105	VCC_12V
C106	VCC_12V	D106	VCC_12V
C107	VCC_12V	D107	VCC_12V
C108	VCC_12V	D108	VCC_12V
C109	VCC_12V	D109	VCC_12V
C110	GND (FIXED)	D110	GND (FIXED)

Appendix **B**

Watchdog Timer

This appendix gives you the information about the watchdog timer programming on the SOM-6894 CPU System on Module.

Sections include:

- Watchdog Timer Programming

B.1 Programming the Watchdog Timer

Trigger Event	Note
IRQ	IRQ5, 7, 14 (BIOS setting default disable)**
NMI	N/A
SCI	Power button event
Power Off	Support
H/W Restart	Support
WDT Pin Activate	Support

** WDT new driver support automatically select available IRQ number from BIOS, and then set to EC. Only Win XP, Win7 and Win8 support it.

In other OS, it will still use IRQ number from BIOS setting as usual.

For details, please refer to *iManager & Software API User Manual*:

Appendix **C**

Programming GPIO

This Appendix gives the illustration of the General Purpose Input and Output pin setting.

Sections include:

- System I/O Ports

C.1 GPIO Register

GPIO Byte Mapping	H/W Pin Name
BIT0	GPO0
BIT1	GPO1
BIT2	GPO2
BIT3	GPO3
BIT4	GPI0
BIT5	GPI1
BIT6	GPI2
BIT7	GPI3

For details, please refer to *iManager & Software API User Manual*.

Appendix **D**

System Assignments

This appendix gives you the information about the system resource allocation on the SOM-6894 CPU System on Module.

Sections include:

- System I/O ports
- DMA Channel Assignments
- Interrupt Assignments
- Memory Map

Note! All System Assignments are based on Haswell-ULT i7 4650U, HD Graphics 5000.



D.1 System I/O Ports

Table D.1: System I/O ports

Addr.Range(Hex)	Device
0000-001F	Direct Memory Access Controller
0000-001F	PCI Bus
0010-001F	Motherboard Resources
0020-0021	Programmable Interrupt Controller
0022-003F	Motherboard Resources
0024-0025	Programmable Interrupt Controller
0028-0029	Programmable Interrupt Controller
002C-002D	Programmable Interrupt Controller
002E-002F	Motherboard Resources
0030-0031	Programmable Interrupt Controller
0034-0035	Programmable Interrupt Controller
0038-0039	Programmable Interrupt Controller
003C-003D	Programmable Interrupt Controller
0040-0043	System Timer
0044-005F	Motherboard Resources
004E-004F	Motherboard Resources
0050-0053	System Timer
0061-0061	Motherboard Resources
0062-0062	Microsoft ACPI-Compliant Embedded Controller
0063-0063	Motherboard Resources
0065-0065	Motherboard Resources
0066-0066	Microsoft ACPI-Compliant Embedded Controller
0067-0067	Motherboard Resources
0070-0070	Motherboard Resources
0070-0070	System CMOS/Real Time Clock
0072-007F	Motherboard Resources
0080-0080	Motherboard Resources
0080-0080	Motherboard Resources
0081-0091	Direct Memory Access Controller
0084-0086	Motherboard Resources
0088-0088	Motherboard Resources
008C-008E	Motherboard Resources
0090-009F	Motherboard Resources
0092-0092	Motherboard Resources
0093-009F	Direct Memory Access Controller
00A0-00A1	Programmable Interrupt Controller

00A2-00BF	Motherboard Resources
00A4-00A5	Programmable Interrupt Controller
00A8-00A9	Programmable Interrupt Controller
00AC-00AD	Programmable Interrupt Controller
00B0-00B1	Programmable Interrupt Controller
00B2-00B3	Motherboard Resources
00B4-00B5	Programmable Interrupt Controller
00B8-00B9	Programmable Interrupt Controller
00BC-00BD	Programmable Interrupt Controller
00C0-00DF	Direct Memory Access Controller
00E0-00EF	Motherboard Resources
0290-029F	Motherboard Resources
029C-029D	Motherboard Resources
02E8-02EF	Communications Port (COM4)
02F8-02FF	Communications Port (COM2)
0378-037F	ECP Printer Port (LPT1)
03B0-03BB	Intel(R) HD Graphics 5000
03C0-03DF	Intel(R) HD Graphics 5000
03E8-03EF	Communications Port (COM3)
03F8-03FF	Communications Port (COM1)
04D0-04D1	Programmable Interrupt Controller
04D0-04D1	Motherboard Resources
0680-069F	Motherboard Resources
0778-077F	ECP Printer Port (LPT1)
0D00-FFFF	PCI Bus
164E-164F	Motherboard Resources
1800-18FE	Motherboard Resources
1854-1857	Motherboard Resources
1C00-1CFE	Motherboard Resources
1D00-1DFE	Motherboard Resources
1E00-1EFE	Motherboard Resources
1F00-1FFE	Motherboard Resources
E000-EFFF	Intel(R) 8 Series PCI Express Root Port #1 - 9C10
F000-F03F	Intel(R) HD Graphics 5000
F040-F05F	Intel(R) 8 Series SMBus Controller - 9C22
F060-F07F	Intel(R) 8 Series SATA AHCI Controller - 9C03
F0A0-F0A3	Intel(R) 8 Series SATA AHCI Controller - 9C03
F0B0-F0B7	Intel(R) 8 Series SATA AHCI Controller - 9C03
F0C0-F0C3	Intel(R) 8 Series SATA AHCI Controller - 9C03
F0D0-F0D7	Intel(R) 8 Series SATA AHCI Controller - 9C03
F0E0-F0E7	Intel(R) Active Management Technology - SOL (COM5)
FFFF-FFFF	Motherboard Resources
FFFF-FFFF	Motherboard Resources
FFFF-FFFF	Motherboard Resources

D.2 DMA Channel Assignments

Table D.2: DMA Channel Assignments

Channel	Function
3	ECP Printer Port (LPT1)
4	Direct memory access controller

D.3 Interrupt Assignments

Table D.3: Interrupt Assignments

Interrupt#	Interrupt Source
0x00000000(IRQ0)	System Timer
0x00000003(IRQ3)	Communications Port (COM2)
0x00000004(IRQ4)	Communications Port (COM1)
0x00000006(IRQ6)	Intel(R) 8 Series SMBus Controller - 9C22
0x00000008(IRQ8)	System CMOS/Real Time Clock
0x0000000A(IRQ10)	Communications Port (COM4)
0x0000000B(IRQ11)	Communications Port (COM3)
0x00000013(IRQ19)	Intel(R) 8 Series SATA AHCI Controller - 9C03
0x00000013(IRQ19)	Intel(R) Active Management Technology - SOL (COM5)
0x00000016(IRQ22)	High Definition Audio Controller
0x00000017(IRQ23)	Intel(R) 8 Series USB Enhanced Host Controller #1 - 9C26
0x00000051- 0x000000BE(IRQ81- IRQ190)	Microsoft ACPI-Compliant System
0xFFFFFFF0(IRQ-6)	Intel(R) Ethernet Connection I218-LM
0xFFFFFFF1(IRQ-5)	Intel(R) Management Engine Interface
0xFFFFFFF2(IRQ-4)	Intel(R) USB 3.0 eXtensible Host Controller
0xFFFFFFF3(IRQ-3)	Intel(R) HD Graphics 5000
0xFFFFFFF4(IRQ-2)	Intel(R) 8 Series PCI Express Root Port #1 - 9C10

D.4 Memory Map

Table D.4: 1st MB Memory Map

Addr. Range (Hex)	Device
0xA0000-0xBFFFF	Intel(R) HD Graphics 5000
0xA0000-0xBFFFF	PCI Bus
0xD0000-0xD3FFF	PCI Bus
0xD4000-0xD7FFF	PCI Bus
0xD8000-0xDBFFF	PCI Bus
0xDC000-0xDFFFF	PCI Bus
0xDF200000-0xFEFFFFFFF	PCI Bus
0xE0000000-0xFFFFFFFF	Intel(R) HD Graphics 5000
0xE0000-0xE3FFF	PCI Bus
0xE4000-0xE7FFF	PCI Bus
0xF0000000-0xF09FFFFFFF	Intel(R) 8 Series PCI Express Root Port #1 - 9C10
0xF7000000-0xF73FFFFFFF	Intel(R) HD Graphics 5000
0xF7400000-0xF7DFFFFFFF	Intel(R) 8 Series PCI Express Root Port #1 - 9C10
0xF7E00000-0xF7E1FFFFF	Intel(R) Ethernet Connection I218-LM
0xF7E20000-0xF7E2FFFFF	Intel(R) USB 3.0 eXtensible Host Controller
0xF7E30000-0xF7E33FFFFF	High Definition Audio Controller
0xF7E39000-0xF7E390FFF	Intel(R) 8 Series SMBus Controller - 9C22
0xF7E3A000-0xF7E3A7FFF	Intel(R) 8 Series SATA AHCI Controller - 9C03
0xF7E3B000-0xF7E3B3FFF	Intel(R) 8 Series USB Enhanced Host Controller #1 - 9C26
0xF7E3C000-0xF7E3CFFFFF	Intel(R) Ethernet Connection I218-LM
0xF7E3D000-0xF7E3DFFFFF	Intel(R) Active Management Technology - SOL (COM5)
0xF7E3F000-0xF7E3F01F	Intel(R) Management Engine Interface
0xF7FDF000-0xF7FDFFFFF	Motherboard Resources
0xF7FE0000-0xF7FEFFFFF	Motherboard Resources
0xF8000000-0xFBFFFFFFF	Motherboard Resources
0xFED00000-0xFED003FFF	High Precision Event Timer
0xFED10000-0xFED17FFF	Motherboard Resources
0xFED18000-0xFED18FFF	Motherboard Resources
0xFED19000-0xFED19FFF	Motherboard Resources
0xFED1C000-0xFED1FFFFF	Motherboard Resources
0xFED20000-0xFED3FFFFF	Motherboard Resources
0xFED40000-0xFED44FFFFF	System Board
0xFED45000-0xFED8FFFFF	Motherboard Resources
0xFED90000-0xFED93FFFFF	Motherboard Resources
0xFEE00000-0xFEEFFFFFFF	Motherboard Resources
0xFF000000-0xFFFFFFFF	Intel(R) 82802 Firmware Hub Device
0xFF000000-0xFFFFFFFF	Motherboard Resources

ADVANTECH

Enabling an Intelligent Planet

www.advantech.com

Please verify specifications before quoting. This guide is intended for reference purposes only.

All product specifications are subject to change without notice.

No part of this publication may be reproduced in any form or by any means, electronic, photocopying, recording or otherwise, without prior written permission of the publisher.

All brand and product names are trademarks or registered trademarks of their respective companies.

© Advantech Co., Ltd. 2013