

MAX9271 Coax Evaluation Kit

Evaluates: MAX9271/MAX9272 with FAKRA Coaxial Cable

General Description

The MAX9271 coax evaluation kit (EV kit) provides a proven design to evaluate the MAX9271 high-bandwidth gigabit multimedia serial link (GMSL) serializer with spread spectrum and full-duplex control channel with the use of a standard FAKRA coaxial cable. The EV kit also includes Windows XP®, Windows Vista®, and Windows® 7-compatible software that provides a simple graphical user interface (GUI) for exercising the features of the device. The EV kit comes with a MAX9271GTJ/V+ installed.

For complete GMSL evaluation, order the MAX9271 coax or STP EV kit and its companion board, the MAX9272 coax or STP EV kit. **Note:** The GUI software is identical for both the coax and STP EV kits for the MAX9271, MAX9272, and MAX9273.

For evaluation using a standard FAKRA coaxial cable, order both the MAX9271 coax EV kit and its companion board, the MAX9272 coax EV kit.

For evaluation using a standard Rosenberger twisted-pair cable, order both the MAX9271 STP EV kit and its companion board, the MAX9272 STP EV kit.

Component List

DESIGNATION	QTY	DESCRIPTION
C1–C4	4	1000pF ±5%, 50V C0G ceramic capacitors (0402) Murata GRM1555C1H102J
C5–C8, C101–C105, C111, C121 C131, C141, 151	14	0.1µF ±10%, 16V X7R ceramic capacitors (0603) TDK C1608X7R1C104K
C15, C16	2	0.22µF ±10%, 50V X7R ceramic capacitors (0805) Murata GRM21BR71H224K
C21	1	4.7µF ±20%, 25V X7R ceramic capacitor (1206) Murata GCM31CR71E475M

Features

- Accepts 16-Bit Parallel Video
- Windows XP-, Windows Vista-, and Windows 7-Compatible Software
- USB-PC Connection (Cable Included)
- USB Powered
- Proven PCB Layout
- Fully Assembled and Tested

Ordering Information appears at end of data sheet.

DESIGNATION	QTY	DESCRIPTION
C22, C24–C26, C109	5	10µF ±20%, 16V X5R ceramic capacitors (1206) Murata GRM31CR61C106M
C23	0	Not installed, ceramic capacitor (1206)
C106, C107, C122, C123	4	22pF ±5%, 50V C0G ceramic capacitor (0603) Murata GRM1885C1H220J
C108	1	1µF ±10%, 16V X5R ceramic capacitor (0603) TDK C1608X5R1C105K
C110	1	0.033µF ±10%, 25V X7R ceramic capacitor (0603) Murata GRM188R71E333K

Windows, Windows XP, Windows Vista and Windows 7 are registered trademarks and registered service marks of Microsoft Corporation.

MAX9271 Coax Evaluation Kit

Evaluates: MAX9271/MAX9272
with FAKRA Coaxial Cable

Component List (continued)

DESIGNATION	QTY	DESCRIPTION
H_DIN12_6	1	14-pin (2 x 7) header
H_DIN15_13	1	6-pin (2 x 3) header
H_DIN5_0	1	12-pin (2 x 6) header
H_GPO, JU21–JU23, JU153, JU154, JU_USB+5V	7	2-pin headers
H_PCLKIN	1	2-pin header
J2, J3	2	50Ω right-angle FAKRA male plug Rosenberger 59S2AX-400A5-Y or Amphenol FA1-NCRP-PCB-9
JU101–JU108, JU141–JU144	0	Not installed, 2-pin headers— short (PCB trace)
JU121, JU122, JU151, JU152, JU_BWS, JU_LCCEN, JU_MS, JU_RXSDA, JU_PWDN, JU_TXSCL	10	3-pin headers
JU_CONF0, JU_CONF1	2	4-pin headers
L21–L23, L101	4	300Ω ±25%, 500mA ferrite beads (0603) TDK MMZ1608R301A
LED120, LED127, LED151–LED158	10	Red LEDs (0805)
LED126	1	Green LED (0805)
R1, R2	0	Not installed, 49.9kΩ ±1% resistors
R3, R4	0	Not installed, 0Ω resistors (0603)
R5, R6	2	49.9Ω ±1% resistors (0603)
R101, R102	2	27Ω ±5% resistors (0603)
R103	1	1.5kΩ ±5% resistor (0603)
R104	1	470Ω ±5% resistor (0603)
R111	1	2.2kΩ ±5% resistor (0603)
R112, R122	2	10kΩ ±5% resistors (0603)

DESIGNATION	QTY	DESCRIPTION
R121	1	1.1kΩ ±5% resistor (0603)
R123, R126, R127, R151–R158	11	1kΩ ±5% resistors (0603)
RESETU12	1	Momentary pushbutton switch (6mm)
SWU15	1	DIP switch
U1	1	GMSL serializer (32 TQFN-EP*) Maxim MAX9271GTJ/V+
U2	1	1.8V, 500mA LDO regulator (8 μMAX®-EP*) Maxim MAX1792EUA18+ (Top Mark: AAAA)
U10	1	UART-to-USB converter (32 TQFP)
U11	1	93C46-type 3-wire EEPROM 16-bit architecture (8 SO)
U12	1	Ultra-high-speed microcontroller (44 TQFP) Maxim DS89C450-ENL+
U13	1	Quad three-state buffer (14 SO) ON Semi MC74AC125DR2
U14	1	Level translator (14 TSSOP) Maxim MAX3378EEUD+
U15	1	I ² C I/O expander (24 QSOP) Maxim MAX7324AEG+
USB1	1	USB type-B right-angle female receptacle
Y10	1	6MHz crystal (HCM49) Hong Kong X'tals SSL60000N1HK188F0-0
Y12	1	14.7456MHz crystal (HCM49) Hong Kong X'tals SSM1474518AFHHF0
—	1	USB high-speed A-to-B cables, 6ft
—	17	Shunts
—	1	PCB: MAX9271 COAX EVALUATION KIT

*EP = Exposed pad.

μMAX is a registered trademark of Maxim Integrated Products, Inc.

Component Suppliers

SUPPLIER	PHONE	WEBSITE
Amphenol RF	800-627-7100	www.amphenolrf.com
Hong Kong X'tals Ltd.	852-35112388	www.hongkongcrystal.com
Murata Electronics North America, Inc.	770-436-1300	www.murata-northamerica.com
ON Semiconductor	602-244-6600	www.onsemi.com
Rosenberger Hochfrequenztechnik GmbH	011-49-86 84-18-0	www.rosenberger.de
TDK Corp.	847-803-6100	www.component.tdk.com

Note: Indicate that you are using the MAX9271 when contacting these component suppliers.

MAX9271 EV Kit Files

FILE	DESCRIPTION
INSTALL.EXE	Installs the EV kit files on your computer
MAX9271.EXE	Application program for both the MAX9271 and MAX9272 devices
CDM20600.EXE	Installs the USB device driver
UNINSTALL.EXE	Uninstalls the EV kit software
USB_Driver_Help_200.PDF	USB driver installation help file

Quick Start

Required Equipment

- MAX9271 coax EV kit (USB cable included)
- MAX9272 coax EV kit (USB cable included)
- 2m Rosenberger FAKRA cable assembly (included with the MAX9272 coax EV kit)
- Parallel data source (such as digital video)
- Optional: Function generator (needed only if parallel data lacks a pixel clock)
- User-supplied Windows XP, Windows Vista, or Windows 7 PC with a spare USB port (direct 500mA connection required; do not use a bus-powered hub)
- 5V DC, 500mA power supply

Note: In the following sections, software-related items are identified by bolding. Text in **bold** refers to items directly from the EV kit software. Text in **bold and underlined** refers to items from the Windows operating system.

Procedure

The EV kit is fully assembled and tested. Follow the steps below to verify board operation:

- 1) Visit www.maximintegrated.com/evkitsoftware to download the latest version of the EV kit software, 9271Rxx.ZIP. Save the EV kit software to a temporary folder and uncompress the ZIP file.
- 2) Install the EV kit software and USB driver on your computer by running the INSTALL.EXE program inside the temporary folder. The program files are copied to your PC and icons are created in the Windows **Start | Programs | Maxim Evkit Software | MAX9271** menu. During software installation, some versions of Windows may show a warning message indicating that this software is from an unknown publisher. This is not an error condition and it is safe to proceed with installation. Administrator privileges are required to install the USB device driver on Windows.
- 3) Verify that all jumpers are in their default positions, as shown in Table 1.

- 4) Connect the positive terminal of the power supply to the VIN PCB pad on the MAX9271 coax EV kit and the negative terminal to the nearest GND PCB pad on the coax MAX9271 EV kit. Also connect the positive terminal of the power supply to the VIN PCB pad on the MAX9272 coax EV kit and the negative terminal to the nearest GND PCB pad on the MAX9272 coax EV kit.
- 5) Connect the FAKRA cable from the MAX9271 coax EV kit J2 connector to the MAX9272 coax EV kit J2 connector. Optionally, connect a second FAKRA cable between the J3 connectors of the two boards.
- 6) Connect the parallel data source to MAX9271 coax EV kit headers H_DIN15_13, H_DIN12_6, and HDIN5_0. Connect pixel clock or function generator to MAX9271 coax EV kit header H_PCLK_IN.
- 7) Connect the USB cable from the PC to the MAX9271 coax EV kit board. A Windows message appears when connecting the EV kit board to the PC for the first time. Each version of Windows has a slightly different message. If you see a Windows message stating **ready to use**, then proceed to the next step. Otherwise, open the USB_Driver_Help_200.PDF document in the Windows **Start | Programs | Maxim Evkit Software | MAX9271** menu to verify that the USB driver was installed successfully.
- 8) Verify that MAX9271 coax EV kit LED120 lights up, indicating that the microcontroller is powered and enabled.
- 9) Verify that MAX9272 coax EV kit LED120 lights up, indicating that the microcontroller is powered and enabled.
- 10) Verify that MAX9272 coax EV kit LED2 lights up, indicating that the link has been successfully established. If LED2 is off or LED1 is on, double-check that the PCLK_IN signal is clocking data.
- 11) Start the MAX9271 coax EV kit software by opening its icon in the **Start | Programs | Maxim Evkit Software | MAX9271** menu. The EV kit software configuration window appears, as shown in Figure 7.
- 12) I²C-to-I²C mode support: To enable I²C-to-I²C mode, select **I2C** from the **Bus** drop-down list in the **Serializer** group box. To configure for I²C-to-I²C mode, change jumpers JU_CONF1 and JU_CONF0, as shown in the dialog box. Change jumpers JU_TXSCL and JU_RXSDA from pins 1-2 to 2-3 to connect to the I²C bus.

- 13) Press the **Connect** button and the configuration window disappears.
- 14) The EV kit software main window appears, as shown in Figure 1.
- 15) Press the **Read All** button to read all registers on the MAX9271 and MAX9272.

Detailed Description of Software

The main window of the evaluation software (Figure 1) shows a block diagram representing the MAX9271/MAX9272 system. The left column shows MAX9271 input data sources and the right column shows MAX9272 output data sinks.

The **Change Configuration** button brings up the **Software Connect** window (Figure 7), allowing the software GUI to select which side of the link the USB cable should be plugged into and the **Jumper Setting** window (Figure 8) to help in configuring the boards. Controlling from the MAX9272 side requires changing some jumper settings, as described in this window. If the MAX9271 and MAX9272 device addresses have been previously changed from their factory power-on-reset (POR) values, the new addresses must be specified in the **Software Connect** window to allow register access.

The **Baud Rate** drop-down list sets the communications baud rate. The USB link uses the same baud rate as the MAX9271/MAX9272. Note that the baud rate should only be changed one step at a time.

The **Read All** button reads all MAX9271 and MAX9272 device registers. The **Reset to Default Values** button restores the recommended factory settings and the **Write All** button writes all MAX9271 and MAX9272 device registers with the values shown in the GUI.

The **MAX9271** tab sheet (Figure 2) provides direct access to all MAX9271 registers and the **MAX9272** tab sheet (Figure 3) provides direct access to all MAX9272 registers. Each register has its own **Read** and **Write** button. The small circle next to the **Read** button turns yellow to indicate an attempted read or write, red to indicate a failed read or write, or green to indicate a successful read or write operation.

The **MAX7324** tab sheet (Figure 4) controls the I²C I/O expander on the remote side of the link. When the USB is plugged into the MAX9271 coax EV kit, the **MAX7324** tab sheet controls the MAX7324 (U15) on the MAX9272 coax EV kit. Note that the MAX7324 actually has two device addresses, but for simplicity, the software GUI only displays the device address associated with the MAX7324 outputs. For details, refer to MAX7324 IC data sheet.

MAX9271 Coax Evaluation Kit

Evaluates: MAX9271/MAX9272 with FAKRA Coaxial Cable

The **PRBS Test** tab sheet (Figure 5) uses the MAX9271 and MAX9272 registers to perform a pseudorandom bit sequence (PRBS) error-rate test. Select the test duration (maximum 32767s = 9.1hrs) from the **Duration** drop-down list in the **Bit Error Rate Test** group box and press **Start**. The software GUI configures the MAX9271 and MAX9272 to begin the PRBS test, counts down the specified delay time, and then reports the final value of the MAX9272 PRBSERR register.

The **Interface History and Low Level Access** tab sheet (Figure 6) shows the recent low-level communications activity between the software GUI and the MAX9271/MAX9272 devices. The **Register Access** group provides arbitrary device read/write control, supporting additional

user-supplied devices besides the on-board MAX9271, MAX9272, and MAX7324. The **Device Address**, **Register**, and **Data** drop-down lists specify the device address and the register within the device, as well as one optional byte of data to be written. Pressing **Write Register** writes 1 byte of data to the specified device register. Pressing **Read Register** reads the specified device register and reports the result in the **Interface History** window. Devices that are not register-based (such as the MAX7324) are supported by **Send Data (no register)** and **Receive Data (no register)**. User-supplied devices requiring other interface protocols must use **Raw TX byte codes** to communicate. Note that in bypass mode, raw data is passed to the user-supplied slave device directly without modification.

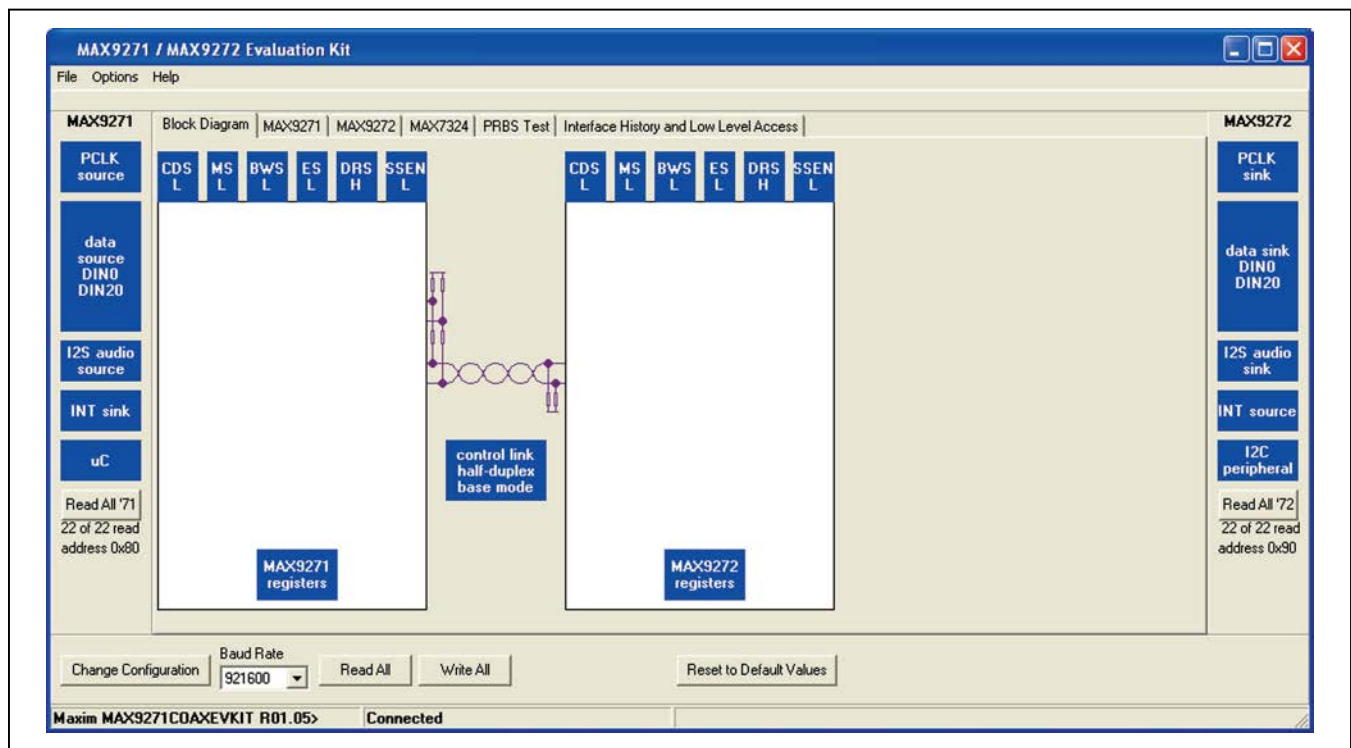

Figure 1. MAX9271/MAX9272 EV Kit Software Main Window (Block Diagram Tab)

MAX9271 Coax Evaluation Kit

Evaluates: MAX9271/MAX9272
with FAKRA Coaxial Cable

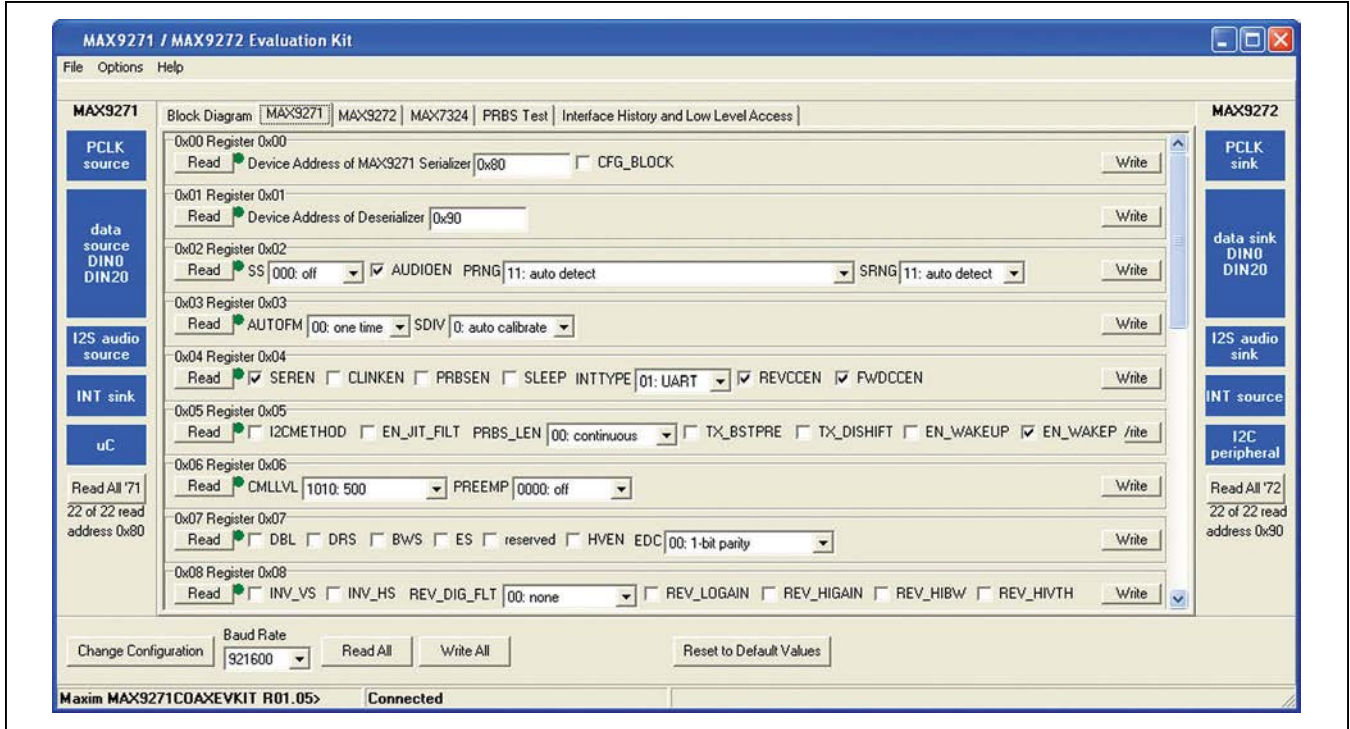

Figure 2. MAX9271/MAX9272 EV Kit Software Main Window (MAX9271 Tab)

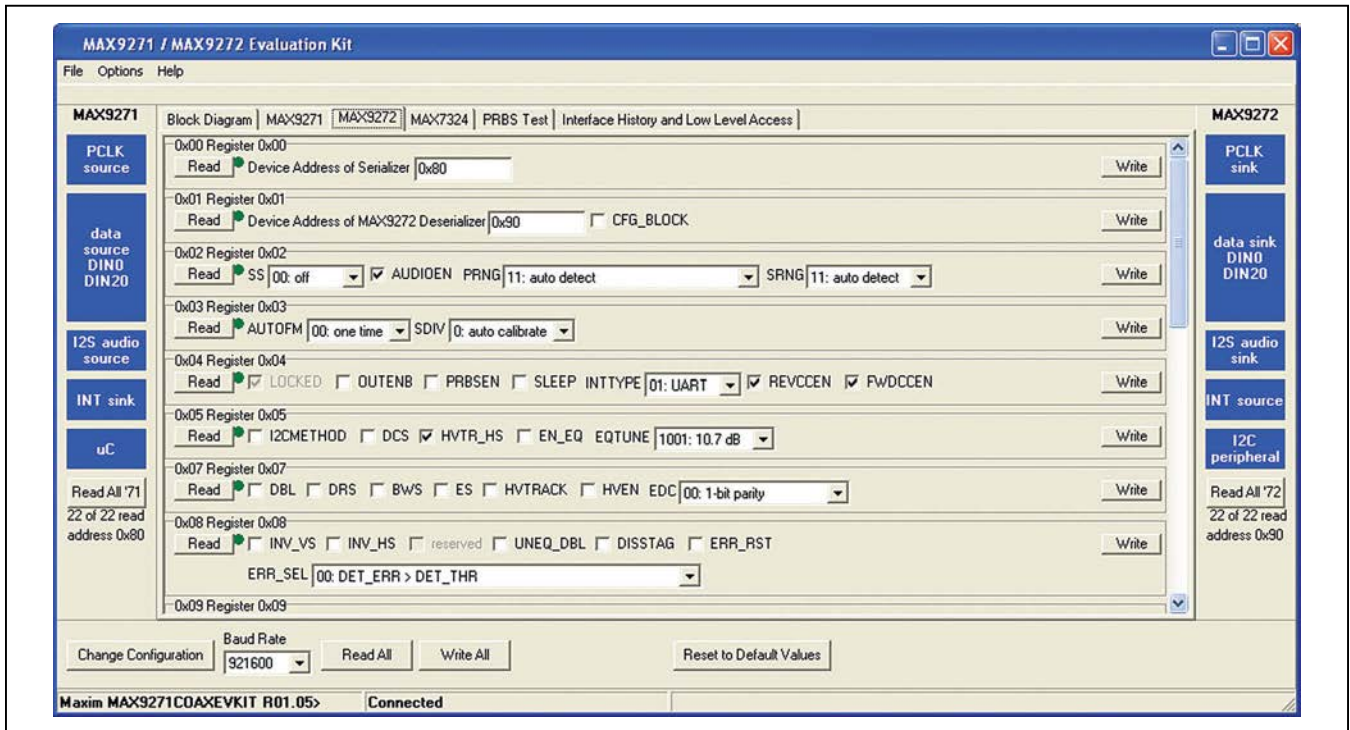

Figure 3. MAX9271/MAX9272 EV Kit Software Main Window (MAX9272 Tab)

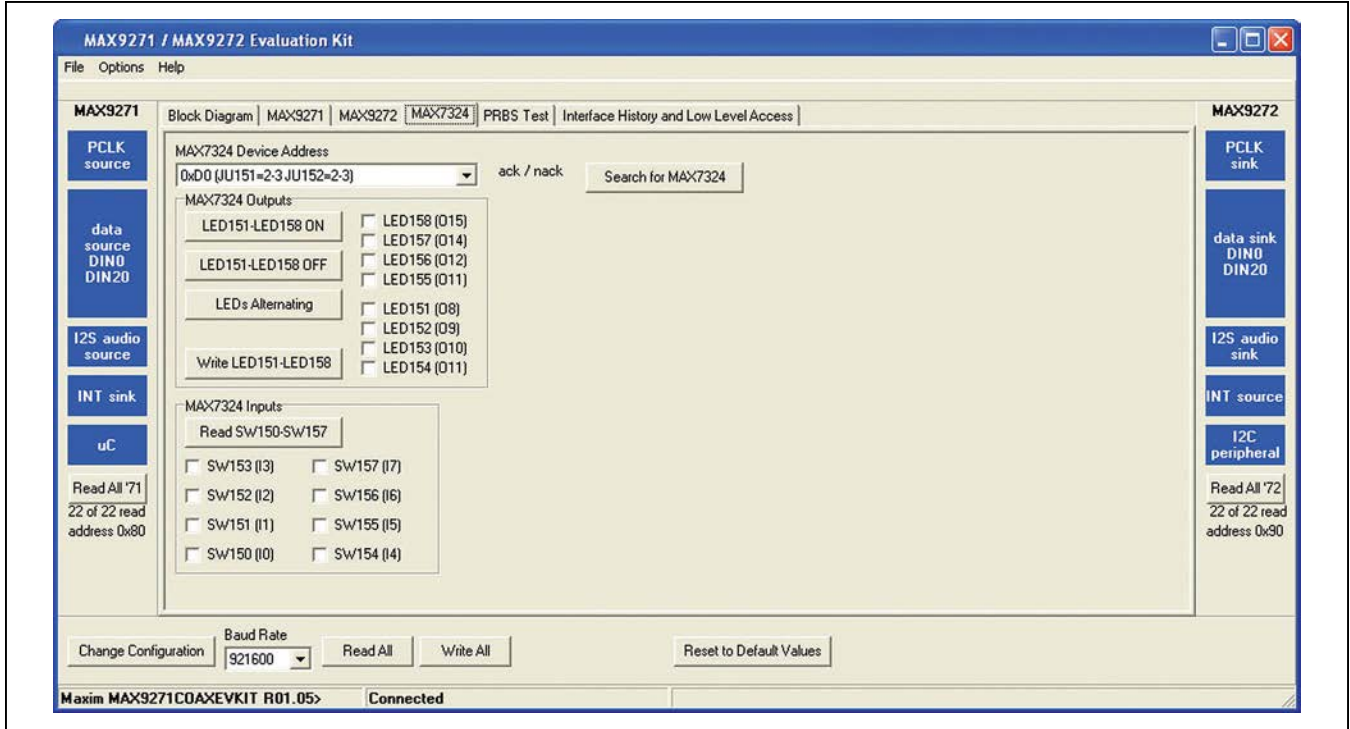

Figure 4. MAX9271/MAX9272 EV Kit Software Main Window (MAX7324 Tab)

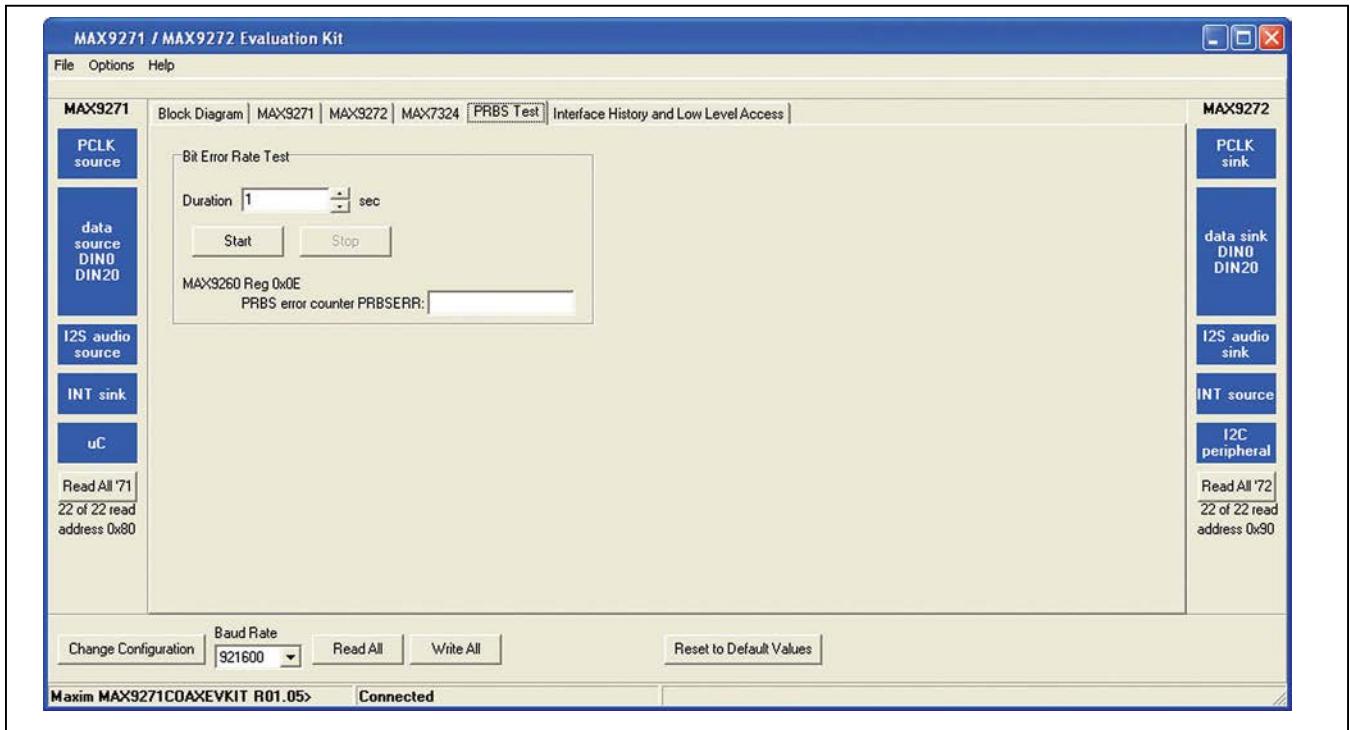

Figure 5. MAX9271/MAX9272 EV Kit Software Main Window (PRBS Tab)

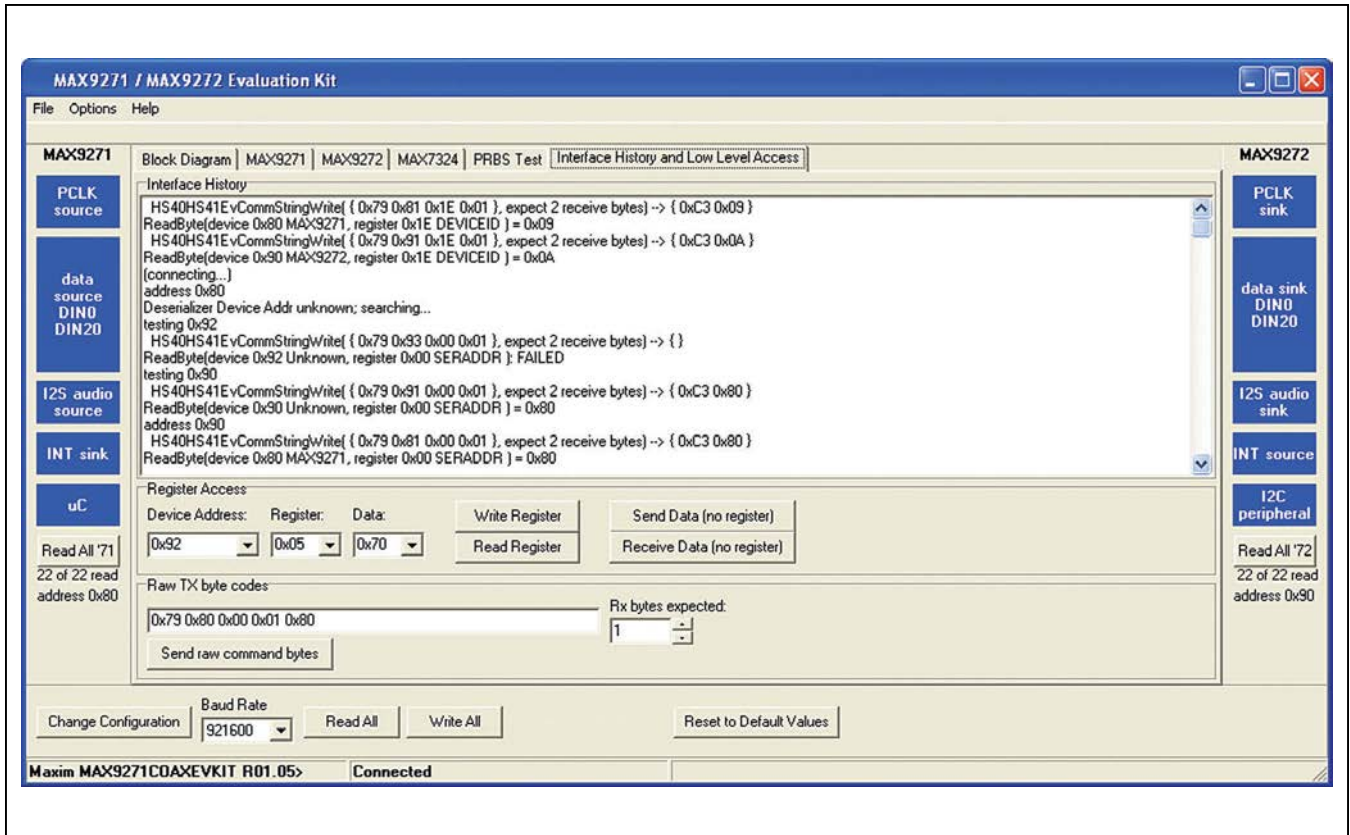

Figure 6. MAX9271 EV Kit Software Main Window (Interface History and Low Level Access Tab)

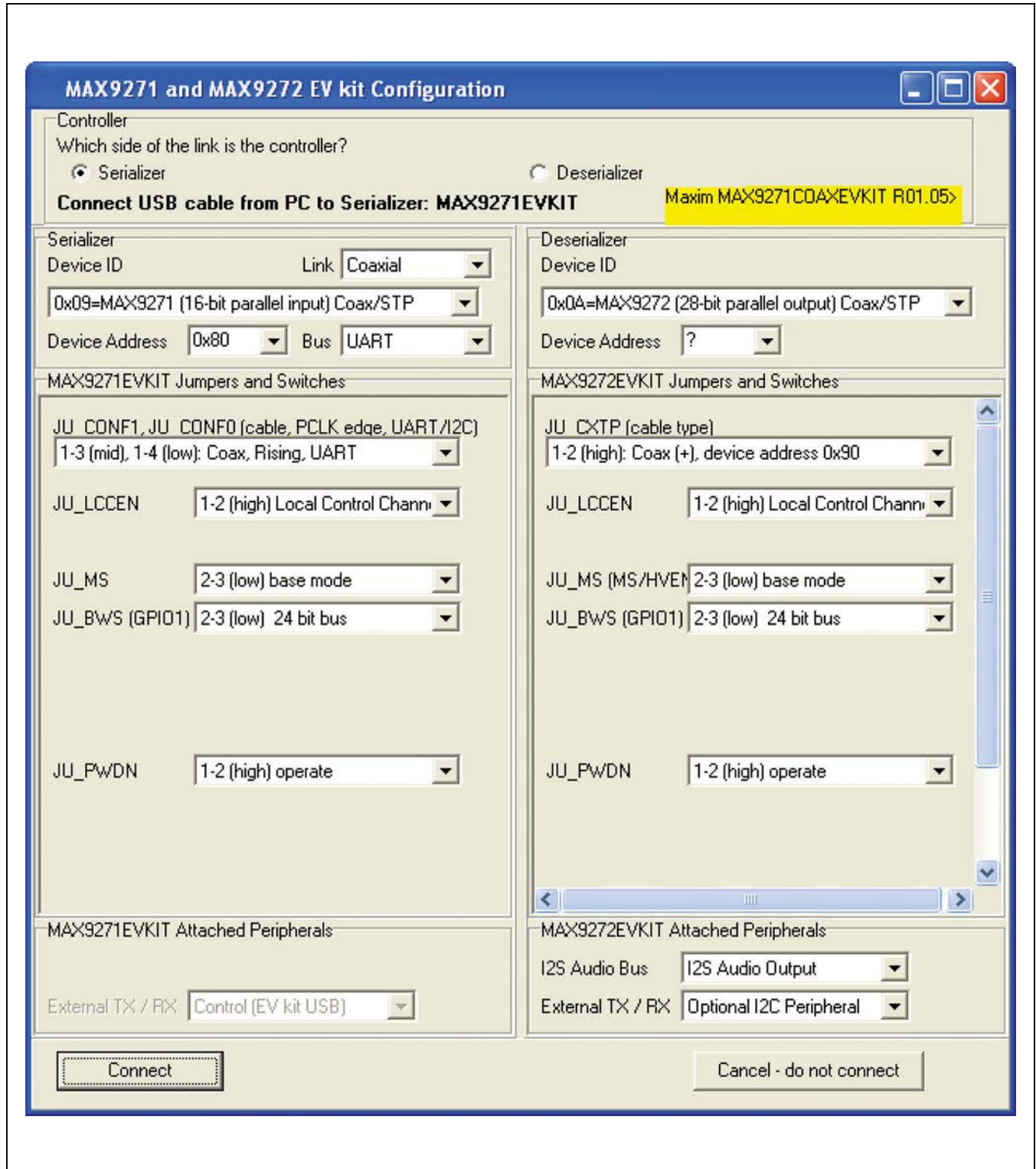

Figure 7. MAX9271/MAX9272 EV Kit Software Connect Window

Detailed Description of Hardware

The MAX9271 coax EV kit provides a proven layout for the MAX9271 GMSL serializer with the use of a standard FAKRA coaxial cable. On-board level translators and easy-to-use USB-PC connection are included on the EV kit.

The MAX9271 coax EV kit board layout is divided into four principal sections:

- 1) Power-supply circuitry. On-board LDO regulator U2 powers the AVDD, DVDD, and IOVDD supplies from VIN.
- 2) MAX9271 and support components.
- 3) Microcontrollers (U10–U14).
- 4) I²C slave device (U15).

The microcontroller and I²C slave device sections are identical on the MAX9271–MAX9273 coax EV kits.

Microcontroller-Supplied I²C Interface

The microcontroller-supplied I²C interface (through U12 and U14) is intended to operate while both serializer and deserializer boards are powered on and locked. If the microcontroller-supplied I²C interface is to be used in any other case, one of the following should be done: Use an IOVDD of 2.2V or greater with the I²C interface, or use a 100kbps I²C data rate.

User-Supplied Interface

To use the MAX9271 coax EV kit with a user-supplied interface, first cut the PCB traces at jumpers JU141 and JU142. Next, apply your own TX/SCL signal at the U1 side of jumper JU141 and RX/SDA at the U1 side of jumper JU142. Refer to the MAX9271 and MAX9272 IC data sheets for details about UART protocol for base mode, write data format, read data format, selecting base mode or bypass mode, and selecting a UART or I²C slave device.

User-Supplied Power Supply

The MAX9271 and MAX9272 coax EV kits are powered completely from the USB port by default. Jumper JU_USB+5V connects the 5V USB supply and the VIN power supply.

To provide different power supplies to AVDD, DVDD, and IOVDD, remove the shunts from jumpers JU21–JU23 and apply external user-supplied power at the AVDD, DVDD, and IOVDD oval PCB pads, respectively.

Detailed Description of Firmware

The DS89C450 microcontroller (U12) runs custom firmware that ensures that no breaks occur within register read/write commands. The firmware records 9-bit even-parity data received from the USB interface while RTS is set, and plays back the 9-bit data with 1.5 stop bits timing when RTS is cleared. Data received from the MAX9271 is immediately relayed to the USB.

The firmware also supports a small set of commands, available when RTS is clear. Since all register read/write requests are sent with RTS set, there is no conflict between register data and firmware commands. These firmware commands are issued automatically by the MAX9271 coax EV kit software GUI. The following information is provided for reference only:

- Firmware command “?” prints the firmware version banner message and brief command list.
- Firmware command “B” changes the baud rate by changing the internal TH1 baud-rate divisor. Refer to the firmware help command “?” for details. Pressing RESETU12 resets the USB baud rate to 921,600 baud. The software GUI automatically sends the baud-rate change command.
- Firmware command “T” supports waking up the MAX9271 from the MAX9272 side of the link. Command “T” performs a dummy read, followed by a delay on the order of 1ms to 8ms, and finally writes a register value. For example, send “T810504800483” to read from device address 0x81 register 0x05, delay 4ms, then write to device address 0x80 register 0x04 data 0x83. This is the MAX9271 wake-up sequence for the default device addresses.
- Firmware commands “R” and “W” read and write device registers. The 8-bit device address, register address, length, and data are sent in hexadecimal format. On success, the return code is “+” followed by the read data. On failure, the return code is “-”.
- Some commands are used only during firmware development. Firmware command “S” simulates a dummy device using on-chip memory, instead of device registers used during firmware development. Firmware command “~” prints a diagnostic trace dump used during firmware development. Firmware commands “1” and “2” perform HDCP link authentication check operations used during firmware development. In normal operation, these commands are not used for the MAX9271.

Table 1. Jumper Descriptions

JUMPER	SIGNAL	SHUNT POSITION	DESCRIPTION
JU_BWS	GPIO1/BWS	1-2	GPIO1/BWS = high. When LCCEN = low, BWS = high selects 30-bit input latch (see Tables 2 and 3).
		2-3	GPIO1/BWS = low. When LCCEN = low, BWS = low selects 22-bit input latch (see Tables 2 and 3).
JU_CONF0	CONF0	1-2	CONF0 = high (see Table 4).
		1-3	CONF0 = mid (see Table 4).
		1-4*	CONF0 = low (see Table 4).
JU_CONF1	CONF1	1-2	CONF1 = high (see Table 4).
		1-3*	CONF1 = mid (see Table 4).
		1-4	CONF1 = low (see Table 4).
JU_LCCEN	LCCEN	1-2*	LCCEN = high. Enable local control-channel signals. Required for software control.
		2-3	LCCEN = low. Use alternate functions. Software control is not supported in this mode because there is no TX/RX or SCL/SDA control.
JU_MS	MS/HVEN	1-2	MS/HVEN = high. When LCCEN = high, MS/HEVN = high selects base mode or bypass mode (see Tables 2 and 3).
		2-3*	MS/HVEN = low. When LCCEN = high, MS/HEVN = high selects base mode or bypass mode (see Tables 2 and 3).
JU_PWDN	$\overline{\text{PWDN}}$	1-2*	$\overline{\text{PWDN}}$ = high. Normal operation.
		2-3	$\overline{\text{PWDN}}$ = low. Power-down.
JU_RXSDA	RX/SDA/EDC	1-2*	RX/SDA = RX from U14 (see Tables 2 and 3).
		2-3	RX/SDA = SDA from U14 (see Tables 2 and 3).
JU_TXSCL	TX/SCL/DBL	1-2*	TX/SCL = TX from U14 (see Tables 2 and 3).
		2-3	TX/SCL = SCL from U14 (see Tables 2 and 3).
JU_USB+5V	Bus power	1-2	VIN connects to USB+5V.
		Open*	USB power is not connected to link cable power.
JU21	AVDD	1-2*	AVDD power from 1.8V LDO U2, powered by VIN.
		Open	AVDD must be provided from an external source.
JU22	DVDD	1-2*	DVDD power from 1.8V LDO U2, powered by VIN.
		Open	DVDD must be provided from an external source.
JU23	IOVDD	1-2*	IOVDD power from 1.8V LDO U2, powered by VIN.
		Open	IOVDD must be provided from an external source.
JU101	Reserved	Not installed*	Reserved for factory diagnostic tests.
JU102	Reserved	Not installed*	Reserved for factory diagnostic tests.
JU103	Reserved	Not installed*	Reserved for factory diagnostic tests.
JU104	Reserved	Not installed*	Reserved for factory diagnostic tests.
JU105	Reserved	Not installed*	Reserved for factory diagnostic tests.
JU106	Reserved	Not installed*	Reserved for factory diagnostic tests.
JU107	Reserved	Not installed*	Reserved for factory diagnostic tests.

Table 1. Jumper Descriptions (continued)

JUMPER	SIGNAL	SHUNT POSITION	DESCRIPTION
JU108	Reserved	Not installed*	Reserved for factory diagnostic tests.
JU121	Reserved	Not installed*	Reserved for factory diagnostic tests.
JU122	Reserved	Pin 1 only*	Reserved for factory diagnostic tests.
JU141	TX/SCL	Not installed*	Connects U1 to U12 through level translator U14.
JU142	RX/SDA	Not installed*	Connects U1 to U12 through level translator U14.
JU143	LFLT	Not installed*	Connects U1 to USB through level translator U14.
JU144	INT	Not installed*	Connects U1 to USB through level translator U14.
JU151	U15 AD2	1-2*	Selects U15 I ² C device address.
		2-3	Selects U15 I ² C device address.
		Open	Reserved for factory diagnostic tests.
JU152	U15 AD0	1-2*	Selects U15 I ² C device address.
		2-3	Selects U15 I ² C device address.
		Open	Reserved for factory diagnostic tests.
JU153	U15 SDA	1-2*	Connects U15 MAX7324 to I ² C bus.
		Open	Disconnects U15 MAX7324 from I ² C bus. MS can be high.
JU154	U15 SCL	1-2*	Connects U15 MAX7324 to I ² C bus.
		Open	Disconnects U15 MAX7324 from I ² C bus. MS can be high.

*Default position.

Table 2. Jumper Descriptions (LCCEN = High)

JUMPER	SIGNAL	SHUNT POSITION	DESCRIPTION
JU_BWS	GPIO1	1-2	GPIO1/BWS = high.
		2-3	GPIO1/BWS = low.
JU_LCCEN	LCCEN	1-2*	LCCEN = high. Enable local control-channel signals. Required for software control.
JU_MS	MS	1-2	MS/HVEN = high. Full-duplex bypass mode. Device registers not accessible.
		2-3*	MS/HVEN = low. Half-duplex base mode. Required when writing to device registers.
JU_RXSDA	RX/SDA	1-2*	RX/SDA = RX from U14. Required when control channel = UART-to-I²C/UART.
		2-3	RX/SDA = SDA from U14. Required when control channel = I²C-to-I²C.
JU_TXSCL	TX/SCL	1-2*	TX/SCL = TX from U14. Required when control channel = UART-to-I²C/UART.
		2-3	TX/SCL = SCL from U14. Required when control channel = I²C-to-I²C.

*Default position.

Table 3. Jumper Descriptions (LCCEN = Low)

JUMPER	SIGNAL	SHUNT POSITION	DESCRIPTION
JU_BWS	BWS	1-2	GPIO1/BWS = high. 30-bit input latch.
		2-3	GPIO1/BWS = low. 22-bit input latch.
JU_LCCEN	LCCEN	2-3	LCCEN = low. Use alternate functions. Software control is not supported in this mode because there is no TX/RX or SCL/SDA control.
JU_MS	HVEN	1-2	MS/HVEN = high.
		2-3	MS/HVEN = low.
JU_RXSDA	EDC	1-2	EDC = high. Enable error detection and correction.
		Open	EDC = low (internal pulldown to ground). Disable error detection and correction.
JU_TXSCL	DBL	1-2	DBL = high. Enable double-input mode.
		Open	DBL = low (internal pulldown to ground.) Disable double-input mode.

Table 4. Jumper Descriptions (JU_CONF1, JU_CONF0)

JU_CONF1 SHUNT POSITION	CONF1	JU_CONF0 SHUNT POSITION	CONF0	OUTPUT CONNECTION	PCLKIN LATCH EDGE	CONTROL CHANNEL
1-4	Low	1-4	Low	Coax	Falling	I ² C-to-I ² C
		1-3	Mid	Coax	Falling	UART-to-I ² C/UART
		1-2	High	Coax	Rising	I ² C-to-I ² C
1-3*	Mid	1-4*	Low	Coax	Rising	UART-to-I ² C/UART
		1-3	Mid	Do not use	Do not use	Do not use
		1-2	High	Do not use	Do not use	Do not use
1-2	High	1-4	Low	Do not use	Do not use	Do not use
		1-3	Mid	Do not use	Do not use	Do not use
		1-2	High	Reserved	Reserved	Reserved

*Default position.

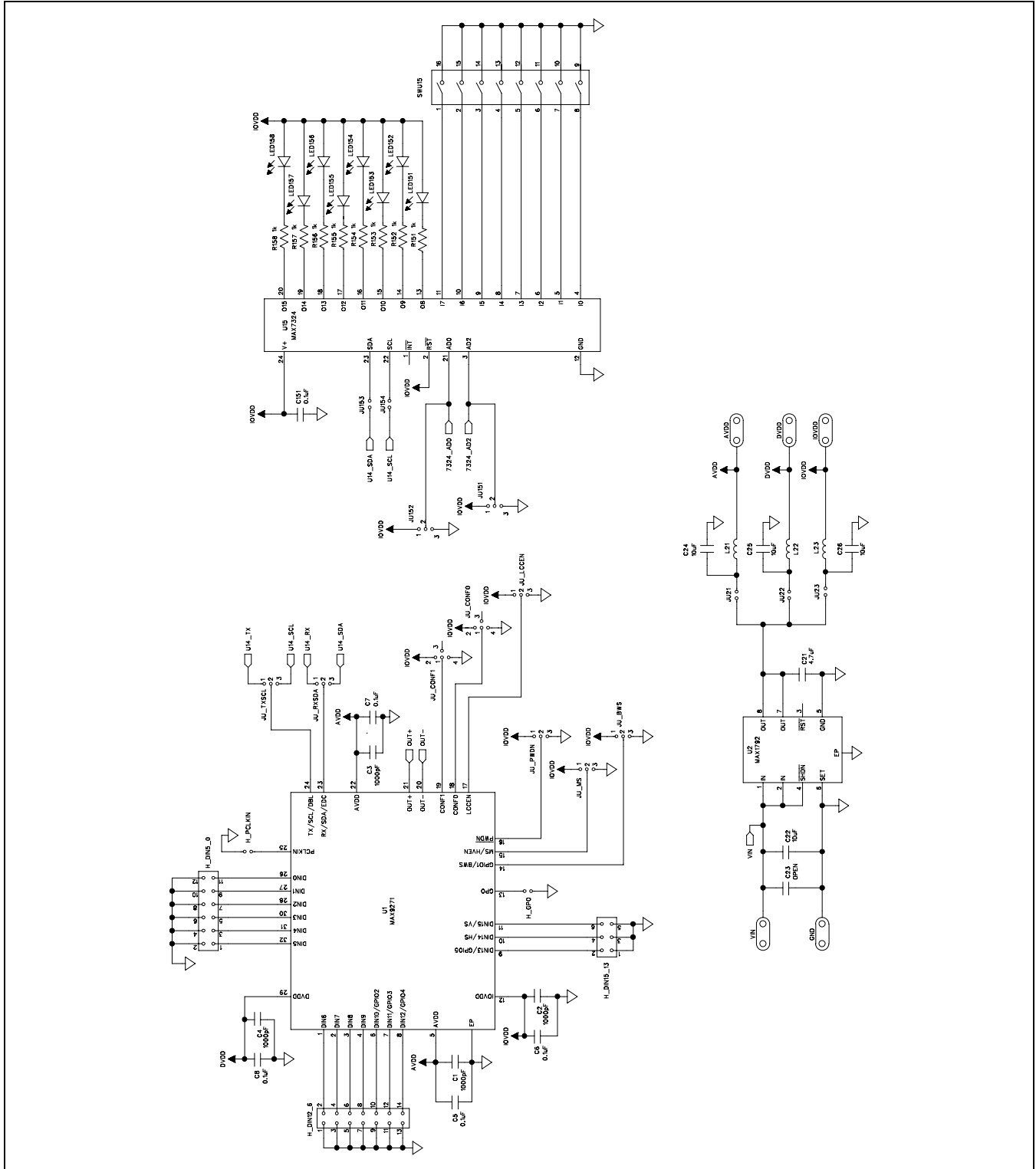

Figure 10a. MAX9271 Coax EV Kit Schematic (Sheet 1 of 3)

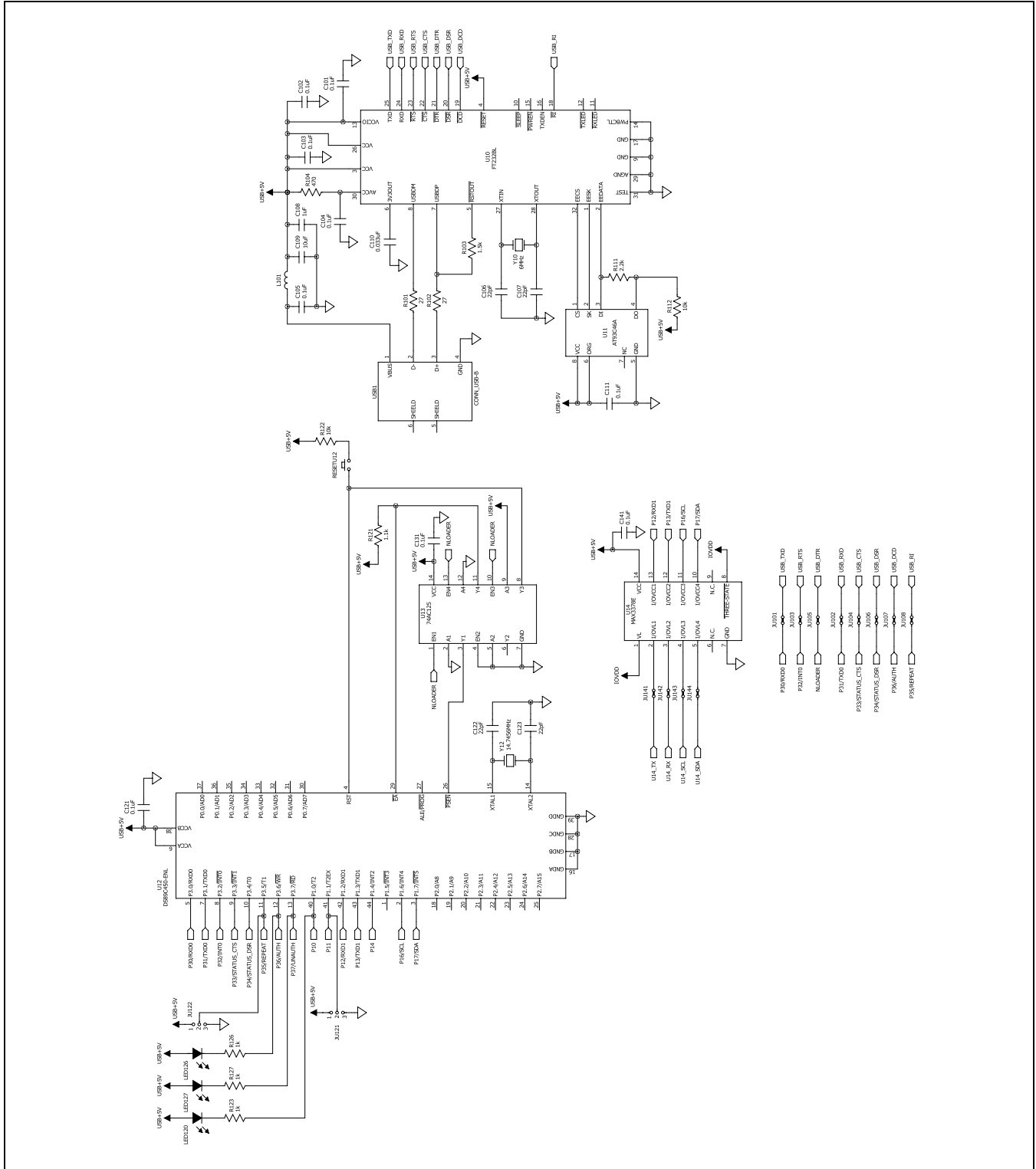

Figure 10b. MAX9271 Coax EV Kit Schematic (Sheet 2 of 3)

MAX9271 Coax Evaluation Kit

Evaluates: MAX9271/MAX9272
with FAKRA Coaxial Cable

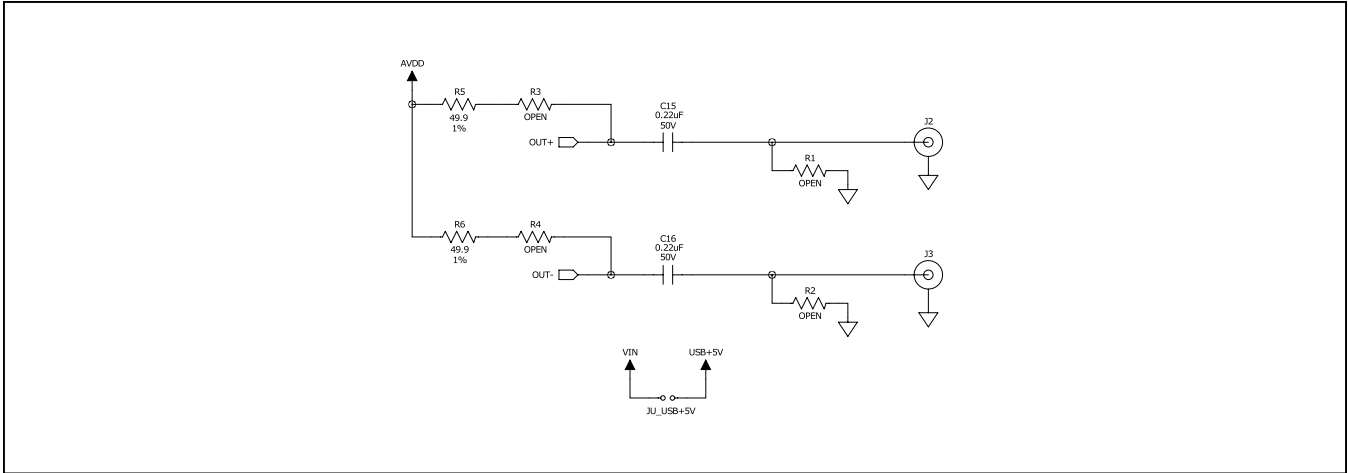

Figure 10c. MAX9271 Coax EV Kit Schematic (Sheet 3 of 3)

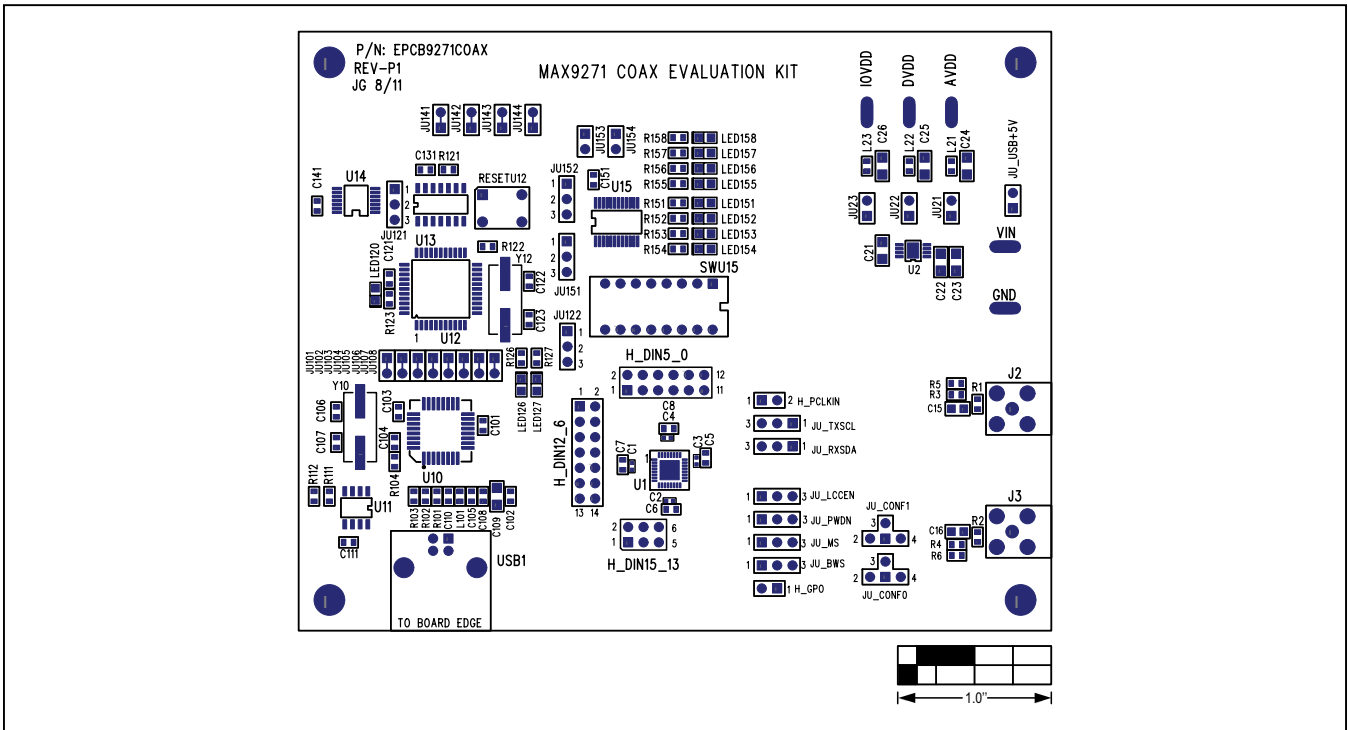

Figure 11. MAX9271 Coax EV Kit Component Placement Guide—Component Side

MAX9271 Coax Evaluation Kit

Evaluates: MAX9271/MAX9272
with FAKRA Coaxial Cable

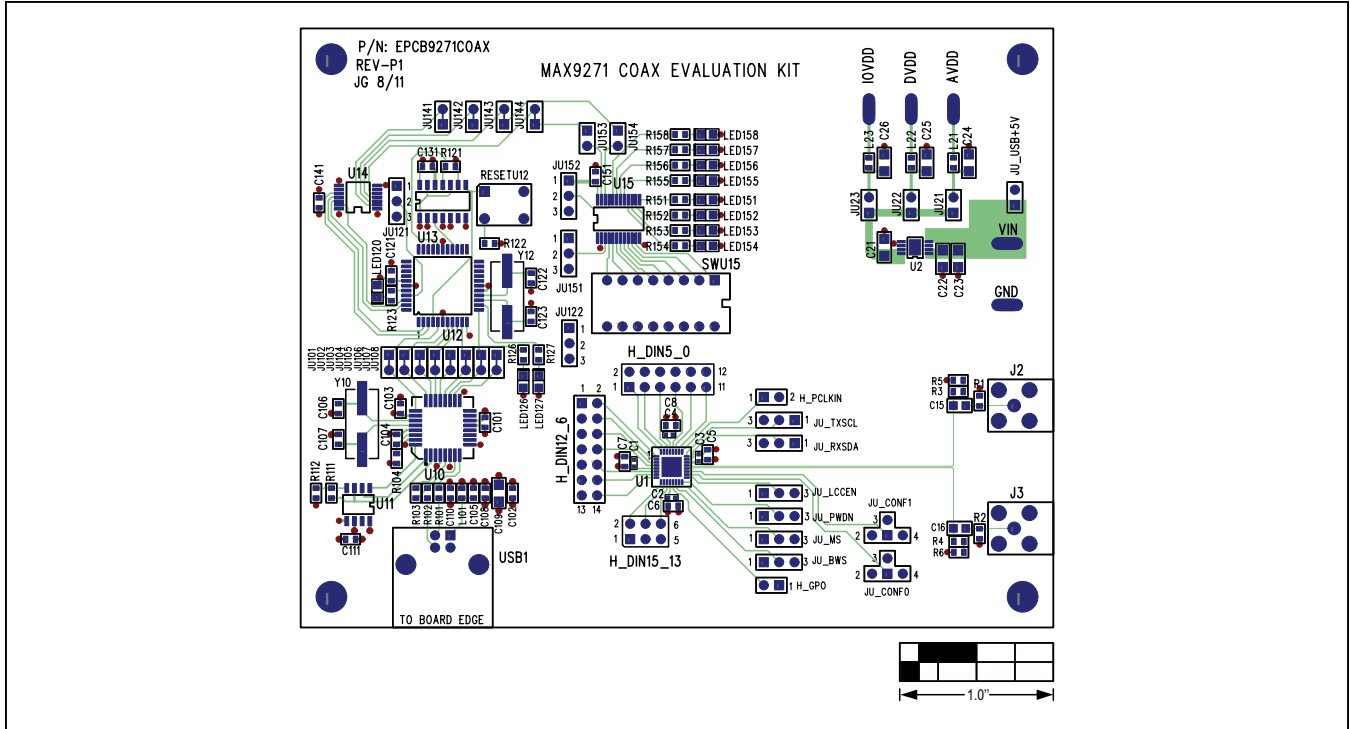

Figure 12. MAX9271 Coax EV Kit PCB Layout—Component Side

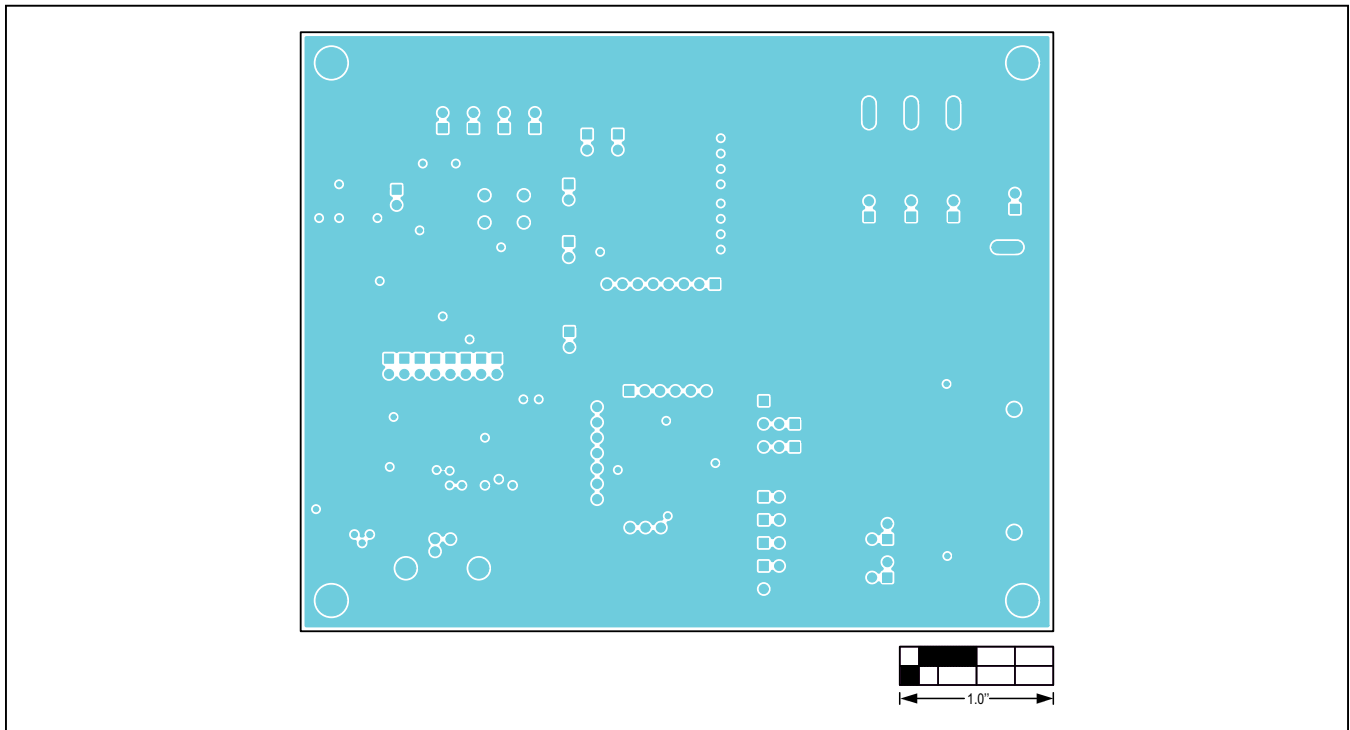

Figure 13. MAX9271 Coax EV Kit PCB Layout—Ground Layer 2

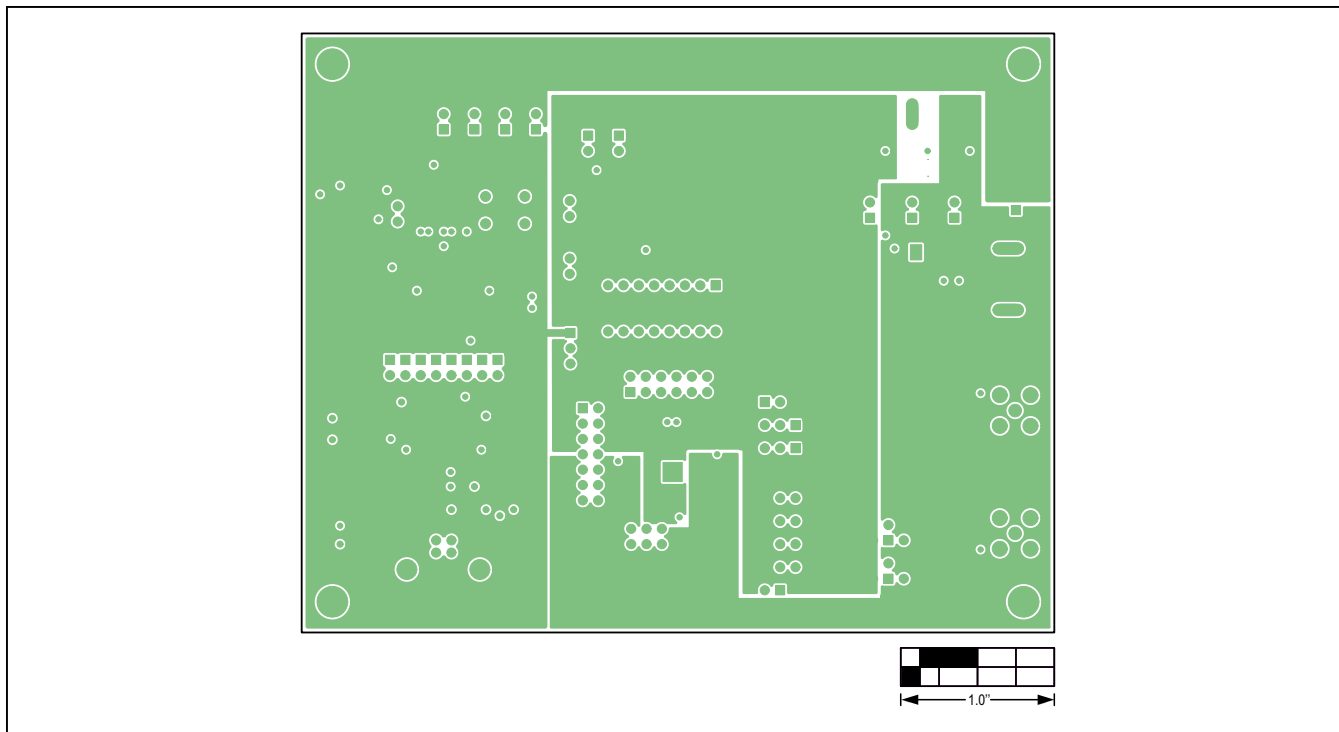

Figure 14. MAX9271 Coax EV Kit PCB Layout—Power Layer 3

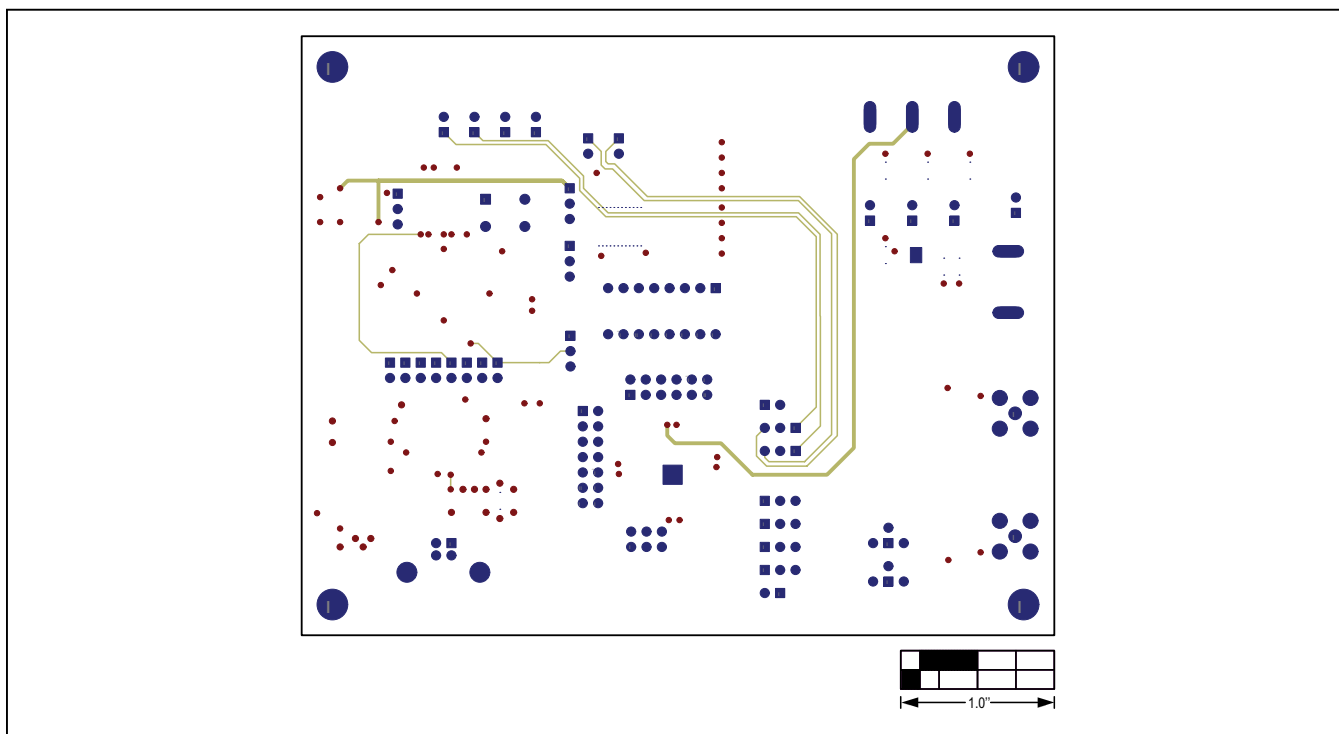

Figure 15. MAX9271 Coax EV Kit PCB Layout—Solder Side

Ordering Information

PART	TYPE
MAX9271COAXEVKIT#	EV Kit

#Denotes RoHS compliant.

Note: *The MAX9271 coax EV kit is normally ordered with its companion board, the MAX9272 coax EV kit.*

Revision History

REVISION NUMBER	REVISION DATE	DESCRIPTION	PAGES CHANGED
0	2/13	Initial release	—

For pricing, delivery, and ordering information, please contact Maxim Direct at 1-888-629-4642, or visit Maxim Integrated's website at www.maximintegrated.com.

Maxim Integrated cannot assume responsibility for use of any circuitry other than circuitry entirely embodied in a Maxim Integrated product. No circuit patent licenses are implied. Maxim Integrated reserves the right to change the circuitry and specifications without notice at any time.