

$V_{RM} = 200\text{ V}$ ,  $I_F = 5\text{ A}$ ,  $10\text{ A}$ ,  $15\text{ A}$

Fast Recovery Diode Built-in Temperature Detection

# FMKS Series



# Data Sheet

## Description

The FMKS Series is the fast recovery diode built-in temperature detection.

A fast recovery diode and a Schottky barrier diode for temperature detection are formed on the same die. Thus, the FMKS Series achieves highly accurate temperature detection that is higher than that with a thermistor, component reduction, power supply downsizing, and easy attachment.

## Features

- Built-in temperature detection
- Highly accurate temperature detection of FRD
- Component reduction of temperature detection
- High speed switching
- Low forward voltage drop

## Typical Application

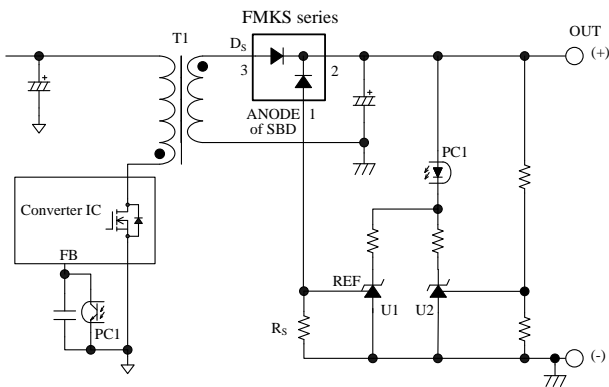

## Package

TO220F-3L

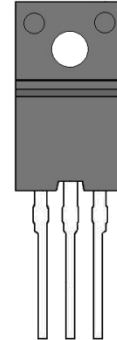

(1)(2)(3)

Not to scale

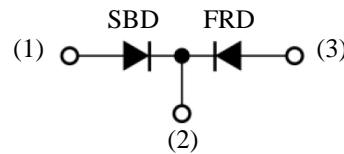

- (1) Anode of Schottky barrier diode, SBD, for temperature detection
- (2) Cathode
- (3) Anode of fast recovery diode, FRD

## FMKS Series

Products	$V_{RM}$	$I_F$	$V_F$	$t_r$
FMKS-2052	200 V	5 A	0.98 V	50 ns
FMKS-2102		10 A		
FMKS-2152		15 A		

where,

$V_{RM}$  is peak reverse voltage,

$I_F$  is average forward current,

$V_F$  is forward voltage drop, and

$t_r$  is reverse recovery time

## Application

The following with thermal protection circuit and peak power limiting circuit, and so forth

- Audio
- White goods
- Power Supplies

CONTENTS

Description ----- 1

CONTENTS ----- 2

1. Absolute Maximum Ratings ----- 3

2. Electrical Characteristics ----- 4

3. Performance Curves ----- 5

    3.1 Schottky Barrier Diode for Temperature Detection Diode Characteristics ----- 5

    3.2 Fast Recovery Diode Characteristics ----- 6

        3.2.1 FMKS-2052 ----- 6

        3.2.2 FMKS-2102 ----- 8

        3.2.3 FMKS-2152 ----- 9

4. External Dimensions ----- 11

5. Marking Diagram ----- 11

6. Temperature Detection Application of FMKS Series ----- 12

IMPORTANT NOTES ----- 14

## FMKS Series

### 1. Absolute Maximum Ratings

Unless specifically noted  $T_A = 25\text{ }^\circ\text{C}$ .

Parameter	Symbol	Conditions	Rating	Unit	Note
<b>Fast Recovery Diode (FRD)</b>					
Transient Peak Reverse Voltage	$V_{RSM}$		200	V	
Peak Repetitive Reverse Voltage	$V_{RM}$		200	V	
Average Forward Current	$I_{F(AV)}$		5	A	FMKS-2052
			10		FMKS-2102
			15		FMKS-2152
Surge Forward Current	$I_{FSM}$	10 ms, half sine wave, one shot	100	A	FMKS-2052
			140		FMKS-2102
			170		FMKS-2152
$I^2t$ Limiting Value	$I^2t$	$1\text{ ms} \leq t \leq 10\text{ ms}$	50	$A^2s$	FMKS-2052
			98		FMKS-2102
			144.5		FMKS-2152
Junction Temperature	$T_j$		-40 to 150	$^\circ\text{C}$	
Storage Temperature	$T_{stg}$		-40 to 150	$^\circ\text{C}$	
Isolation Voltage	-	Between the case and each pin, 1 minute, ac	1.0	kV	
<b>Schottky Barrier Diode for Temperature Detection (SBD)</b>					
Transient Peak Reverse Voltage	$V_{RSM}$		90	V	
Peak Repetitive Reverse Voltage	$V_{RM}$		90	V	
Junction Temperature	$T_j$		-40 to 150	$^\circ\text{C}$	
Storage Temperature	$T_{stg}$		-40 to 150	$^\circ\text{C}$	

## FMKS Series

### 2. Electrical Characteristics

Unless specifically noted  $T_A = 25\text{ }^\circ\text{C}$ .

Parameter	Symbol	Conditions	Min.	Typ.	Max.	Unit	Note
<b>Fast Recovery Diode (FRD)</b>							
Forward Voltage Drop	$V_F$	$I_F = 5\text{ A}$	–	–	0.98	V	FMKS-2052
		$I_F = 10\text{ A}$	–	–	0.98		FMKS-2102
		$I_F = 15\text{ A}$	–	–	0.98		FMKS-2152
Reverse Leakage Current	$I_R$	$V_R = V_{RM}$	–	–	50	$\mu\text{A}$	FMKS-2052
			–	–	100		FMKS-2102
			–	–	150		FMKS-2152
Reverse Leakage Current Under High Temperature	$H \cdot I_R$	$V_R = V_{RM}$ $T_j = 150\text{ }^\circ\text{C}$	–	–	3	mA	FMKS-2052
			–	–	6		FMKS-2102
			–	–	10		FMKS-2152
Reverse Recovery Time	$t_{rr1}$	$I_F = I_{RP} = 100\text{ mA}$ , $T_j = 25\text{ }^\circ\text{C}$ , 90 % recovery point	–	–	50	ns	
	$t_{rr2}$	$I_F = 100\text{ mA}$ , $I_{RP} = 200\text{ mA}$ , $T_j = 25\text{ }^\circ\text{C}$ , 75 % recovery point	–	–	35	ns	
Thermal Resistance*	$R_{th(j-c)}$		–	–	4.0	$^\circ\text{C/W}$	
<b>Schottky Barrier Diode for Temperature Detection Diode (SBD)</b>							
Reverse Leakage Current	$I_{R1}$	$V_R = 15\text{ V}$	–	–	50	$\mu\text{A}$	
	$I_{R2}$	$V_R = 90\text{ V}$	–	–	2.0	mA	
Reverse Leakage Current Under High Temperature	$H \cdot I_{R1}$	$V_R = 15\text{ V}$ , $T_j = 130\text{ }^\circ\text{C}$	1.20	1.90	2.60	mA	
	$H \cdot I_{R2}$	$V_R = 90\text{ V}$ , $T_j = 150\text{ }^\circ\text{C}$	–	–	55	mA	

\*  $R_{th(j-c)}$  is thermal resistance between junction and case.

3. Performance Curves

3.1 Schottky Barrier Diode for Temperature Detection Diode Characteristics

In Figure 3-1, the reverse voltage of Schottky Barrier Diode for temperature detection (SBD),  $V_R$ , is 15V. The temperature of fast recovery diode (FRD) can be estimated by using Figure 3-1.

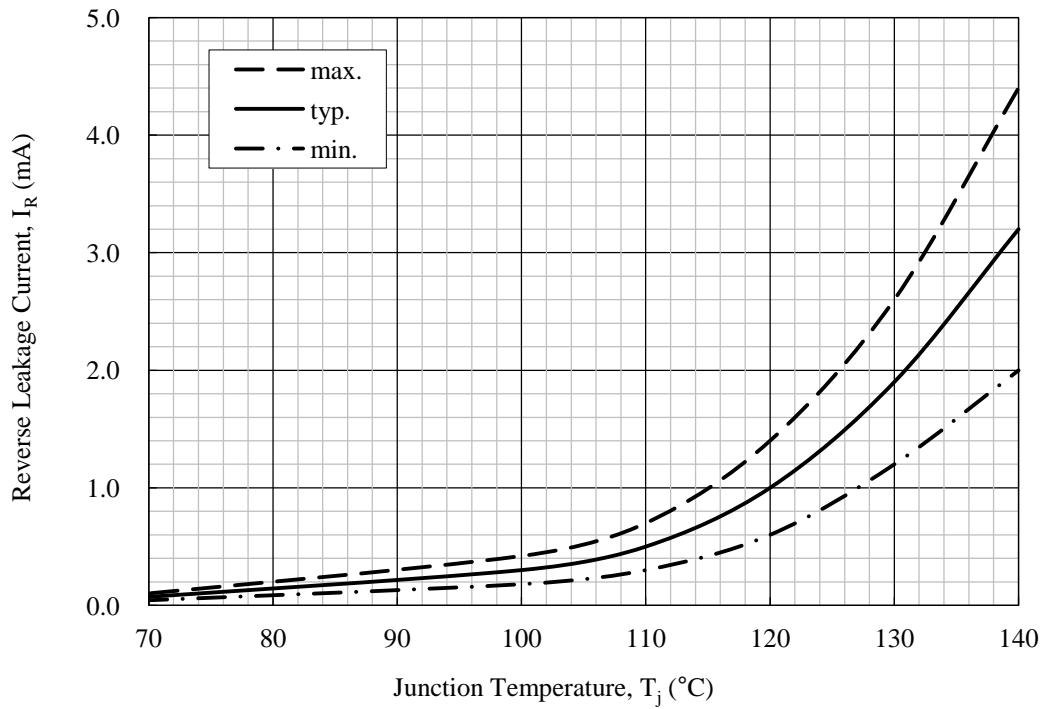

Figure 3-1 Temperature dependent of Reverse Leakage Current,  $I_R$  (SBD)

### 3.2 Fast Recovery Diode Characteristics

T is a pulse cycle, t is a pulse width.

#### 3.2.1 FMKS-2052

##### 3.2.1.1. Typical Characteristics

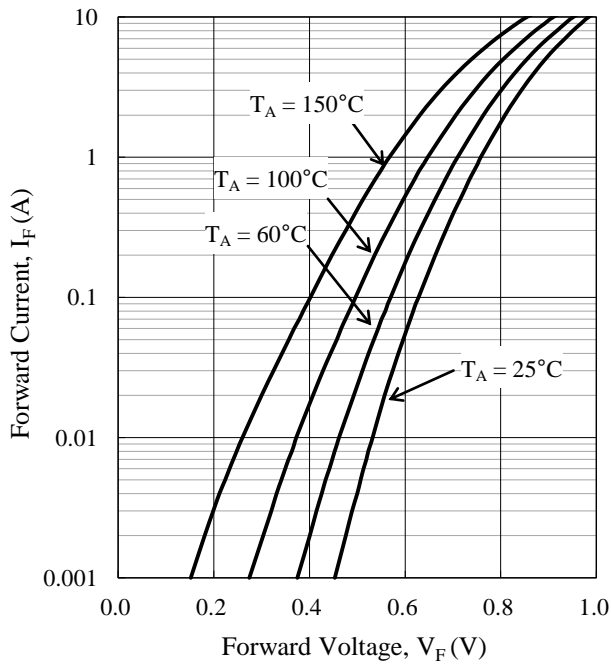

Figure 3-2  $I_F - V_F$  Typical Characteristics

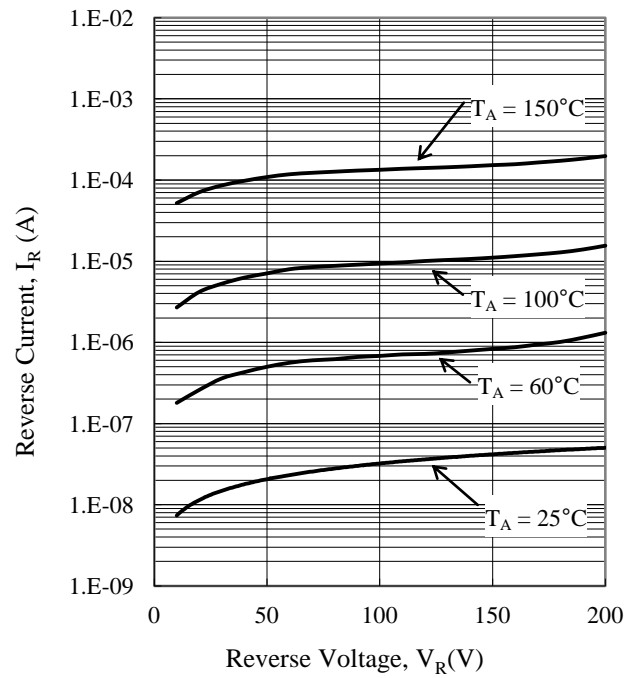

Figure 3-3  $I_R - V_R$  Typical Characteristics

3.2.1.2. Power Dissipation Curves ( $T_j = 150\text{ }^\circ\text{C}$ )

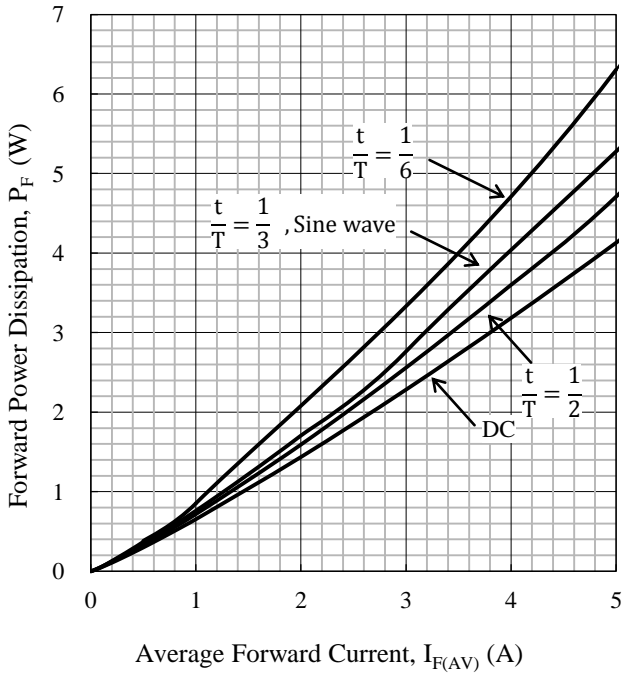

Figure 3-4  $P_F - I_{F(AV)}$

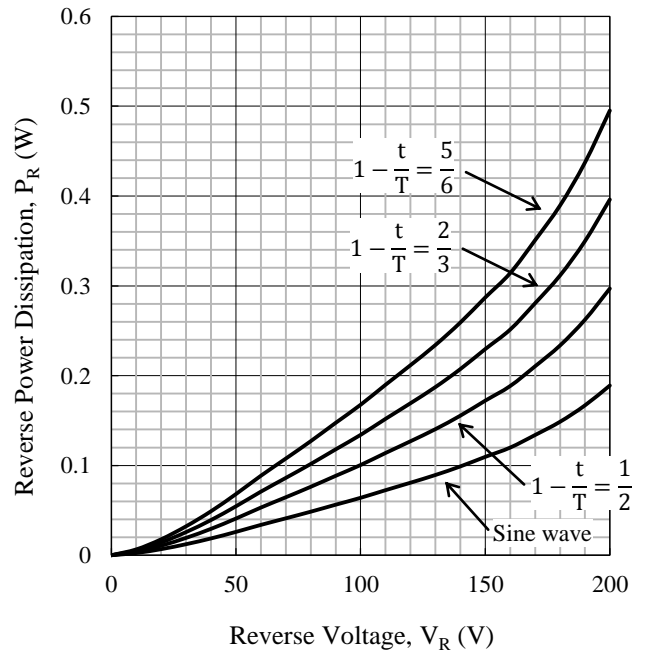

Figure 3-5  $P_R - V_R$

3.2.1.3. Derating Curves ( $T_j = 150\text{ }^\circ\text{C}$ )

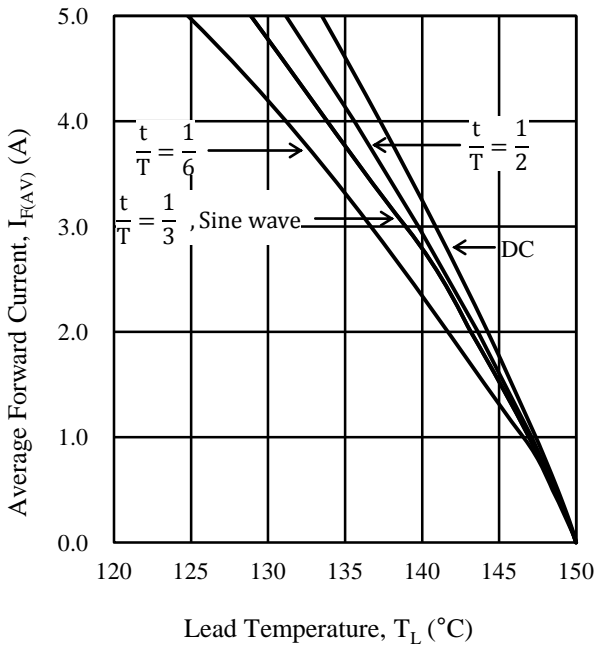

Figure 3-6  $I_{F(AV)} - T_L (V_R = 0\text{ V})$

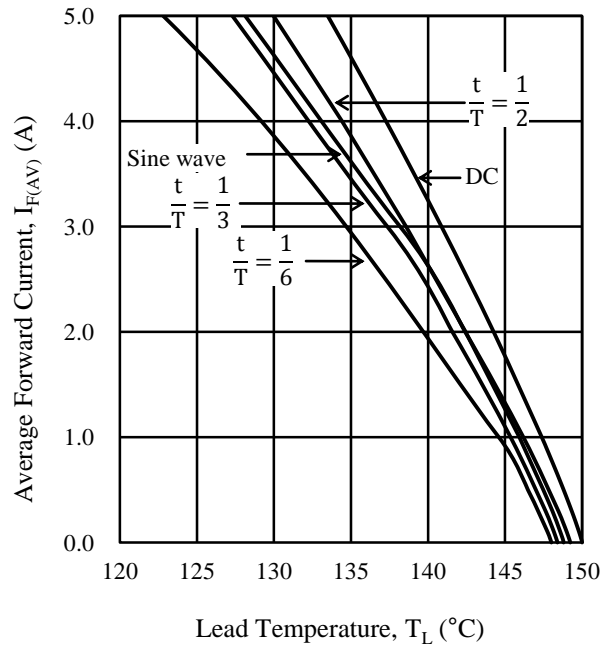

Figure 3-7  $I_{F(AV)} - T_L (V_R = 200\text{ V})$

3.2.2 FMKS-2102

3.2.2.1. Typical Characteristics

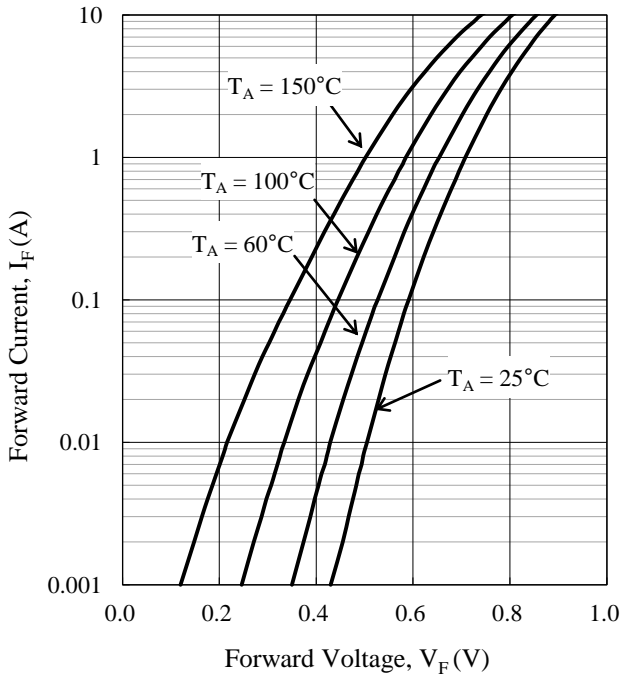

Figure 3-8  $V_F - I_F$  Typical Characteristics

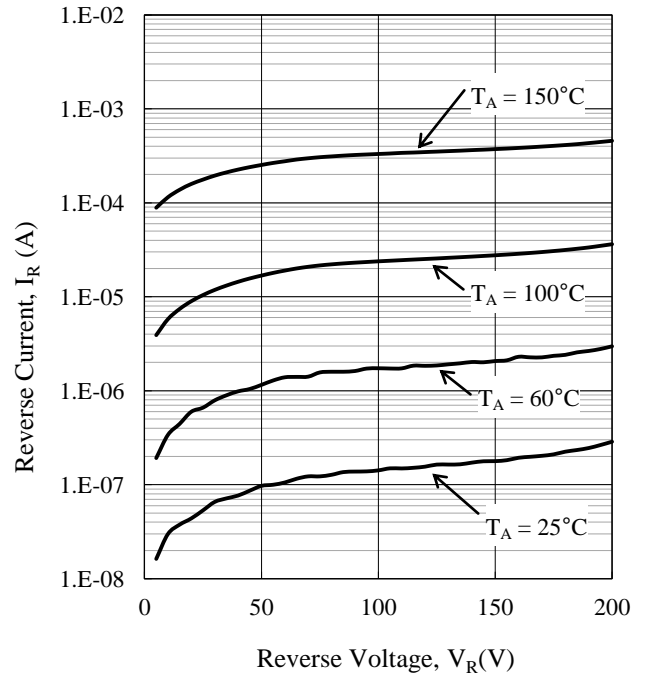

Figure 3-9  $V_R - I_R$  Typical Characteristics

3.2.2.2. Power Dissipation Curves ( $T_j = 150^\circ\text{C}$ )

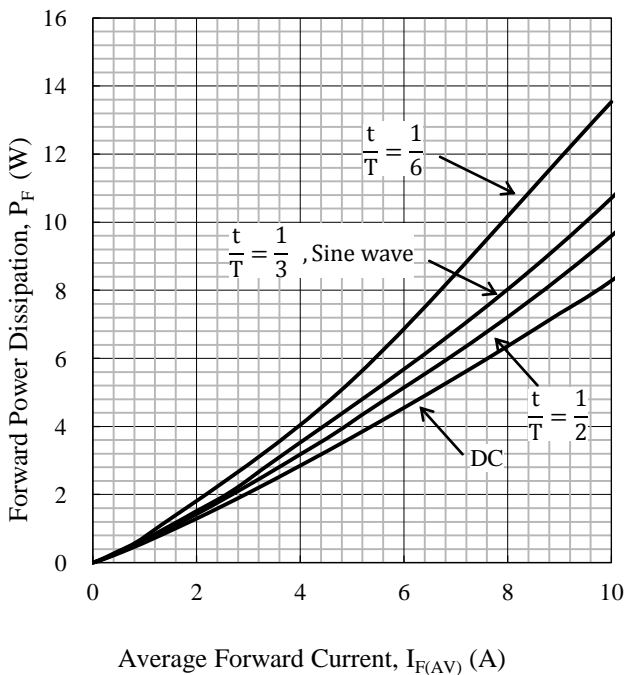

Figure 3-10  $P_F - I_{F(AV)}$

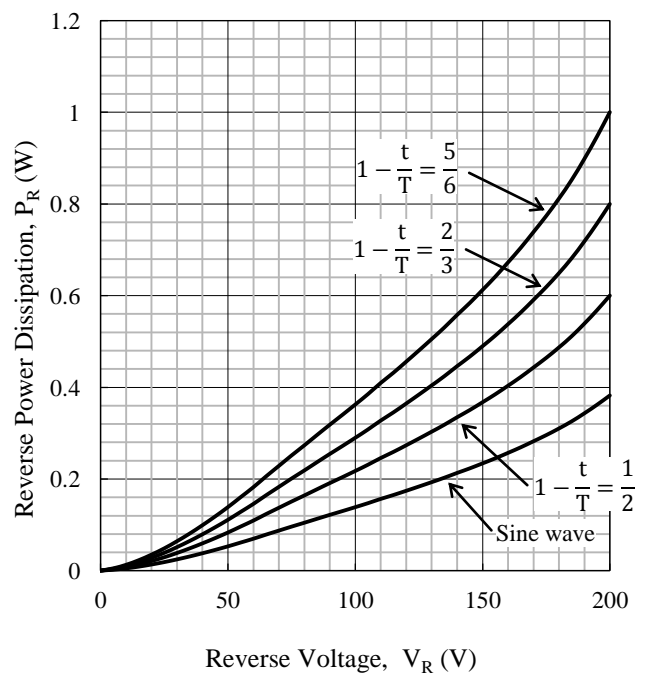

Figure 3-11  $P_R - V_R$



3.2.2.3. Derating Curves ( $T_j = 150^\circ\text{C}$ )

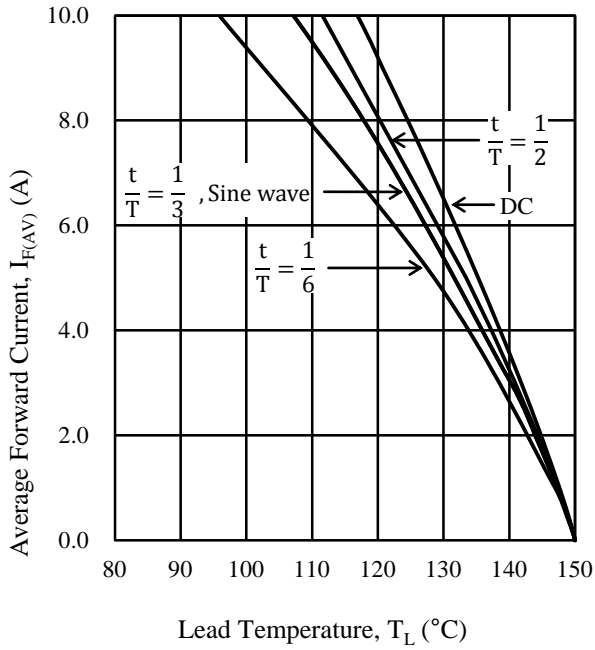

Figure 3-12  $I_{F(AV)} - T_L$  ( $V_R = 0\text{ V}$ )

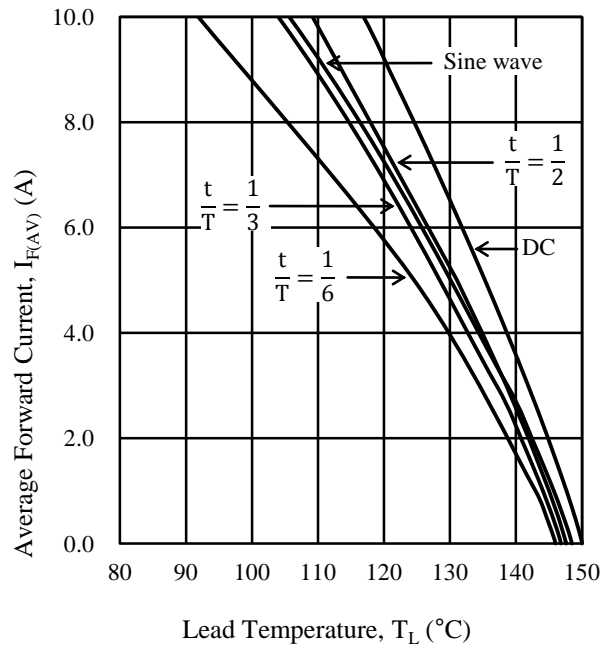

Figure 3-13  $I_{F(AV)} - T_L$  ( $V_R = 200\text{ V}$ )

3.2.3 FMKS-2152

3.2.3.1. Typical Characteristics

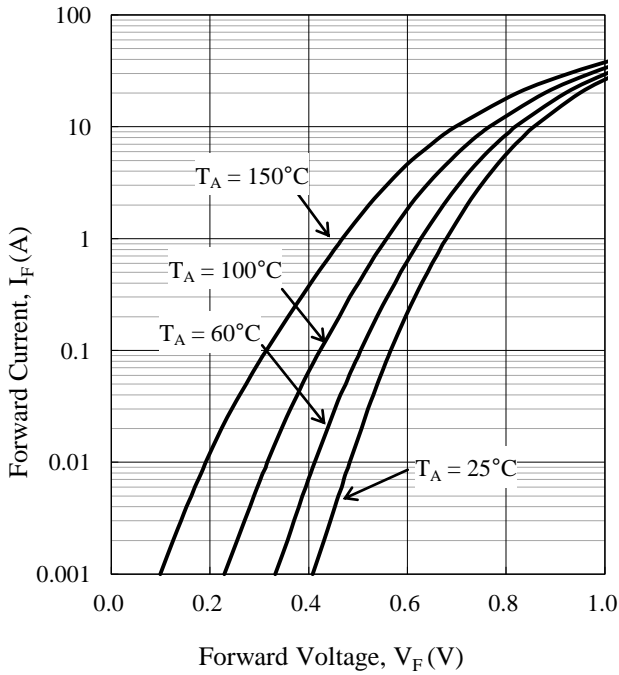

Figure 3-14  $V_F - I_F$  Typical Characteristics

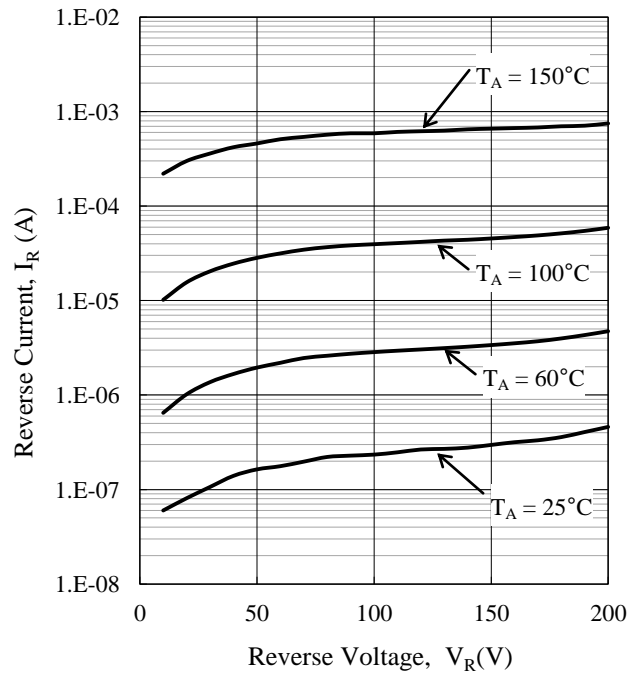

Figure 3-15  $V_R - I_R$  Typical Characteristics

3.2.3.2. Power Dissipation Curves ( $T_j = 150\text{ }^\circ\text{C}$ )

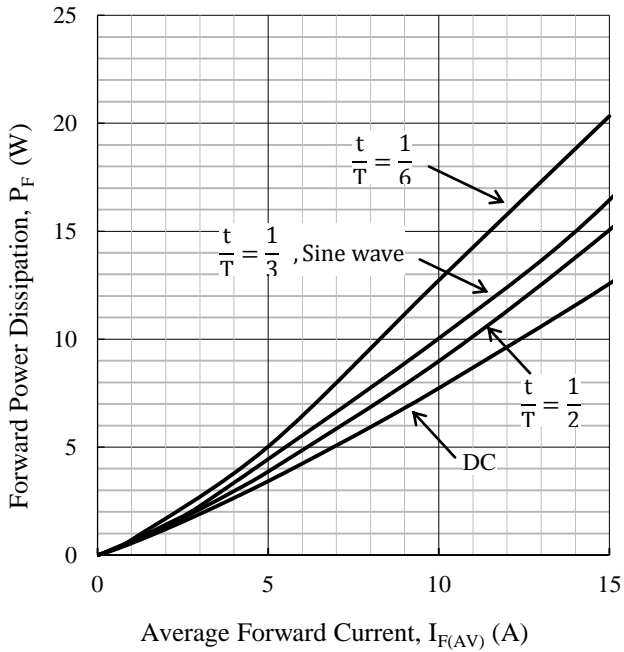

Figure 3-16  $P_F - I_{F(AV)}$

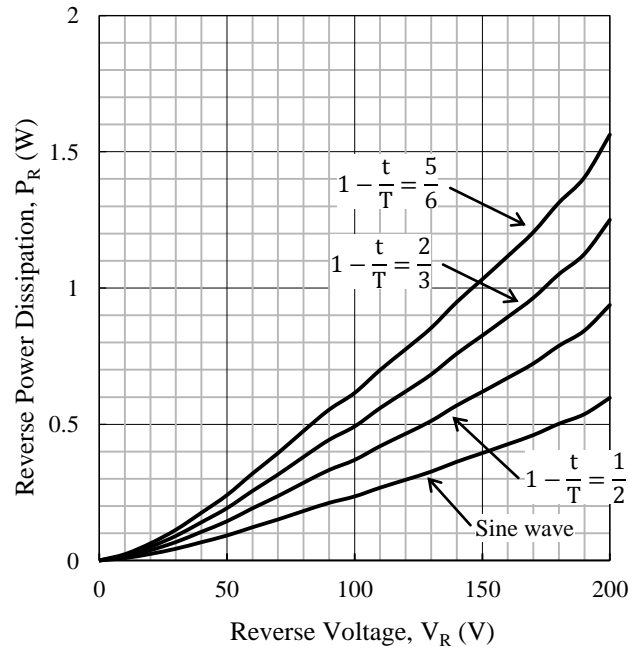

Figure 3-17  $P_R - V_R$

3.2.3.3. Derating Curves ( $T_j = 150\text{ }^\circ\text{C}$ )

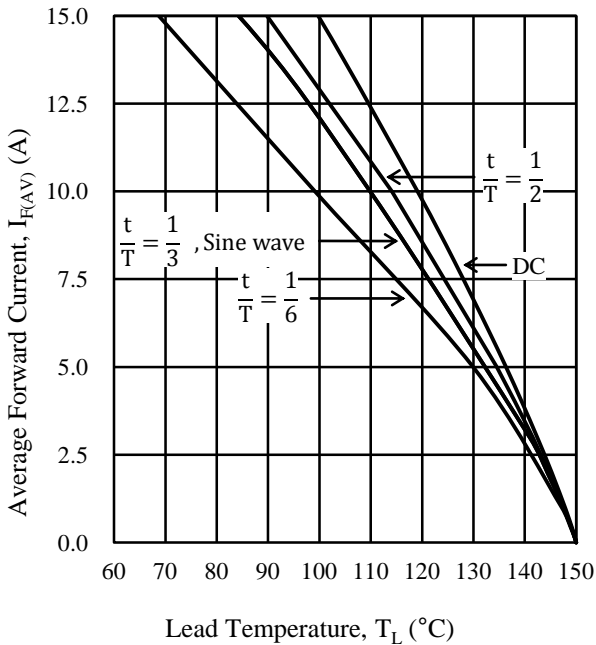

Figure 3-18  $I_{F(AV)} - T_L$  ( $V_R = 0\text{ V}$ )

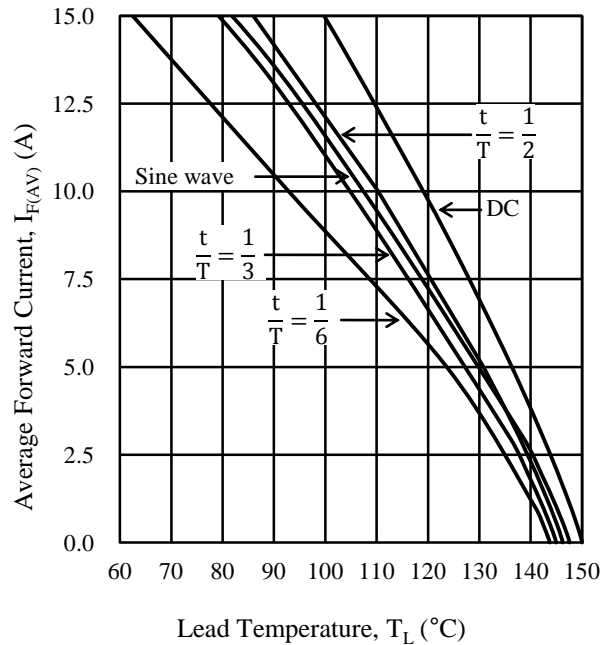
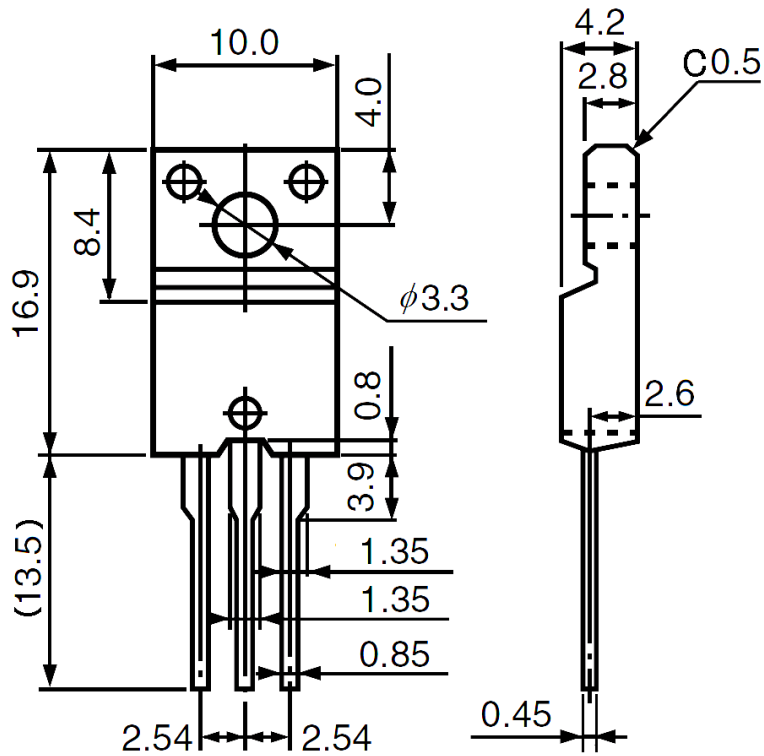

Figure 3-19  $I_{F(AV)} - T_L$  ( $V_R = 200\text{ V}$ )

4. External Dimensions

TO220F-3L



NOTES:

- Dimension is in millimeters.
- Lead treatment Pb-free. Device composition compliant with the RoHS directive.

5. Marking Diagram

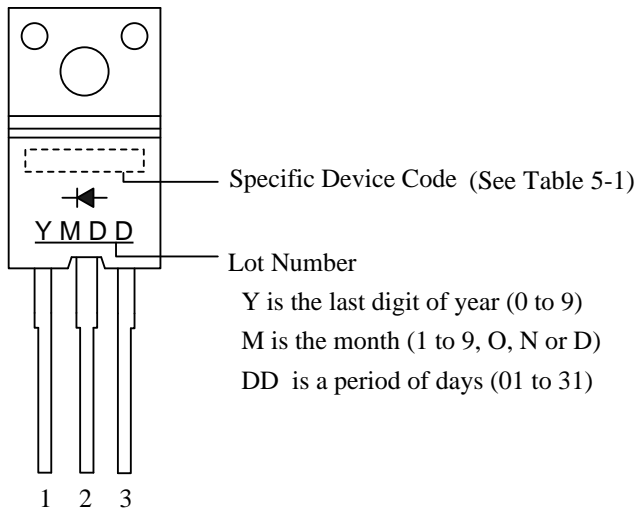

Table 5-1 Specific Device Code

Specific Device Code	Products
KS2052	FMKS-2052
KS2102	FMKS-2102
KS2152	FMKS-2152



Figure 6-5 shows the reference of temperature detection circuit with FMKS series. The ANODE pin of SBD for the temperature detection in  $D_S$  secondary rectifier diode is connected to the REF pin of the shunt regulator of the output voltage detection circuit in the converter.

When the temperature of  $D_S$  rises due to such a cause as overload state, the leakage current,  $I_R$ , of SBD for temperature detection increases, and the voltage of  $R_S$  shown in Figure 6-5 increases. When  $R_S$  voltage reaches the reference voltage of U1 shunt regulator, the current flows to PC1 optocoupler, and the converter IC in the primary limits the output power. Thus, the rise of  $D_S$  temperature can be limited.

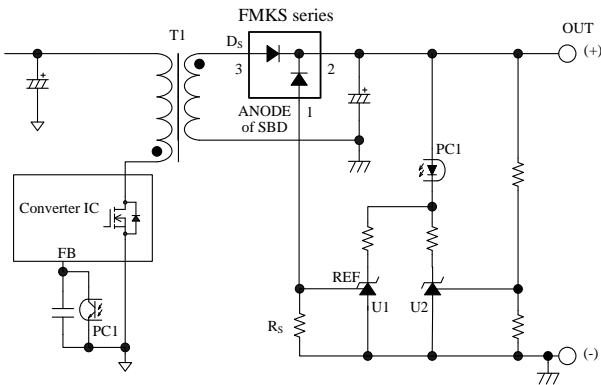

Figure 6-5 Reference temperature detection circuit with FMKS series.

In Figure 6-5,  $R_S$  value is calculated as follows.

$$R_S = \frac{V_{REF}}{I_{R(TD)MAX}}$$

where,

$V_{REF}$  is the reference voltage of U1 shunt regulator,  
 $I_{R(TD)MAX}$  is the maximum leakage current of SBD at the temperature detection value of  $T_D$  in Figure 6-6 or Section 3.1.

When  $T_D$  is 115 °C,  $I_{R(TD)MAX}$  is 1 mA as shown Figure 6-6. Thus, when  $V_{REF}$  is 2.5 V,  $R_S$  value is 2.5 kΩ, and thus the FMKS series can detect in the range of 115 °C to 127 °C.

When  $R_S$  value is chosen 2.7 kΩ from E24 series close to the above value,  $I_{R(TD)MAX}$  is 0.93 mA, and thus the temperature detection range is 114 °C to 126 °C.

When the junction temperature of SBD rises close to 150 °C, the leakage current of SBD increases rapidly and the power dissipation increases. Thus,  $R_S$  should be set so that the temperature is detected in 140 °C or less including variation.

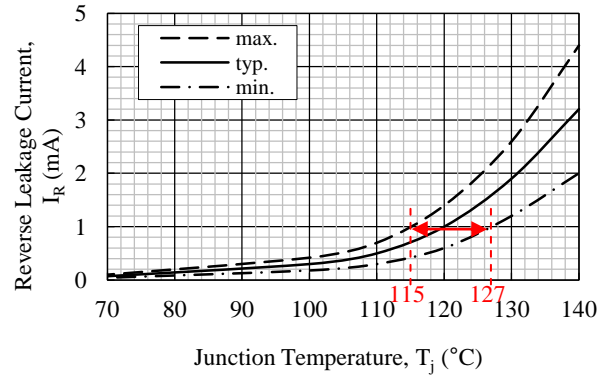

Figure 6-6 Temperature detection range at  $I_R=1.0mA$

Figure 6-7 shows the reference circuit for multi-outputs with FMKS series in off-line flyback converter.

In the case that FMKS series and the synchronous rectification device,  $Q_{SYN}$ , for the other output are attached on the same heatsink so that the temperature from  $Q_{SYN}$  is conducted to FMKS series, the FMKS series can detect the temperature in the following.

- The overload state of  $Q_{SYN}$ .
- The rectification state by the rectifier diode in  $Q_{SYN}$  because the synchronous rectification IC malfunctions and thus  $Q_{SYN}$  is kept off.

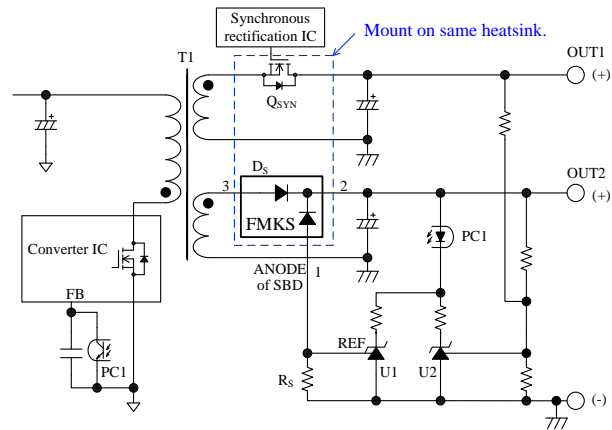

Figure 6-7 Reference circuit with FMKS series in the multi-output flyback converter circuit

**IMPORTANT NOTES**

- All data, illustrations, graphs, tables and any other information included in this document as to Sanken's products listed herein (the "Sanken Products") are current as of the date this document is issued. All contents in this document are subject to any change without notice due to improvement, etc. Please make sure that the contents set forth in this document reflect the latest revisions before use.
- The Sanken Products are intended for use as components of general purpose electronic equipment or apparatus (such as home appliances, office equipment, telecommunication equipment, measuring equipment, etc.). Prior to use of the Sanken Products, please put your signature, or affix your name and seal, on the specification documents of the Sanken Products and return them to Sanken. If considering use of the Sanken Products for any applications that require higher reliability (transportation equipment and its control systems, traffic signal control systems or equipment, disaster/crime alarm systems, various safety devices, etc.), you must contact a Sanken sales representative to discuss the suitability of such use and put your signature, or affix your name and seal, on the specification documents of the Sanken Products and return them to Sanken, prior to the use of the Sanken Products. Any use of the Sanken Products without the prior written consent of Sanken in any applications where extremely high reliability is required (aerospace equipment, nuclear power control systems, life support systems, etc.) is strictly prohibited.
- In the event of using the Sanken Products by either (i) combining other products or materials therewith or (ii) physically, chemically or otherwise processing or treating the same, you must duly consider all possible risks that may result from all such uses in advance and proceed therewith at your own responsibility.
- Although Sanken is making efforts to enhance the quality and reliability of its products, it is impossible to completely avoid the occurrence of any failure or defect in semiconductor products at a certain rate. You must take, at your own responsibility, preventative measures including using a sufficient safety design and confirming safety of any equipment or systems in/for which the Sanken Products are used, upon due consideration of a failure occurrence rate or derating, etc., in order not to cause any human injury or death, fire accident or social harm which may result from any failure or malfunction of the Sanken Products. Please refer to the relevant specification documents and Sanken's official website in relation to derating.
- No anti-radioactive ray design has been adopted for the Sanken Products.
- No contents in this document can be transcribed or copied without Sanken's prior written consent.
- The circuit constant, operation examples, circuit examples, pattern layout examples, design examples, recommended examples and evaluation results based thereon, etc., described in this document are presented for the sole purpose of reference of use of the Sanken Products and Sanken assumes no responsibility whatsoever for any and all damages and losses that may be suffered by you, users or any third party, or any possible infringement of any and all property rights including intellectual property rights and any other rights of you, users or any third party, resulting from the foregoing.
- All technical information described in this document (the "Technical Information") is presented for the sole purpose of reference of use of the Sanken Products and no license, express, implied or otherwise, is granted hereby under any intellectual property rights or any other rights of Sanken.
- Unless otherwise agreed in writing between Sanken and you, Sanken makes no warranty of any kind, whether express or implied, as to the quality of the Sanken Products (including the merchantability, or fitness for a particular purpose or a special environment thereof), and any information contained in this document (including its accuracy, usefulness, or reliability).
- In the event of using the Sanken Products, you must use the same after carefully examining all applicable environmental laws and regulations that regulate the inclusion or use of any particular controlled substances, including, but not limited to, the EU RoHS Directive, so as to be in strict compliance with such applicable laws and regulations.
- You must not use the Sanken Products or the Technical Information for the purpose of any military applications or use, including but not limited to the development of weapons of mass destruction. In the event of exporting the Sanken Products or the Technical Information, or providing them for non-residents, you must comply with all applicable export control laws and regulations in each country including the U.S. Export Administration Regulations (EAR) and the Foreign Exchange and Foreign Trade Act of Japan, and follow the procedures required by such applicable laws and regulations.
- Sanken assumes no responsibility for any troubles, which may occur during the transportation of the Sanken Products including the falling thereof, out of Sanken's distribution network.
- Although Sanken has prepared this document with its due care to pursue the accuracy thereof, Sanken does not warrant that it is error free and Sanken assumes no liability whatsoever for any and all damages and losses which may be suffered by you resulting from any possible errors or omissions in connection with the contents included herein.
- Please refer to the relevant specification documents in relation to particular precautions when using the Sanken Products, and refer to our official website in relation to general instructions and directions for using the Sanken Products.