

Limit Switches - Safety Type Plastic Body IP65 and Metal Body IP66



- High mechanical resistant
- Double Insulation □ (for thermoplastic type)
- Degree of protection IP65 (thermoplastic) IP66 (metal)
- Reinforced UL-V0 thermoplastic fiber-glass body
- Zinc alloy (Zamack) or aluminium body
- Positive Opening Operation ☺
- Minimum Actuation Force/Torque
- Minimum Force to achieve Positive Opening Operation
- Precise operating points (consistency)
- Immune to electromagnetic disturbances
- Zb type contact blocks
- Current Ith = 10A
- Rated insulation voltage Ui = 500V
- UL, CSA, CE
- Conform with IEC 947-5-1 (EN 60947-5-1)

Product Description

They are developed in order to be used for following operations:
For monitoring and protection of industrial machines, without inertia, in which down-time is less than access time to the dangerous area.
Use on sliding or pivoting protectors (covers, cases, doors, grids, etc.).
To protect operators working on dangerous machines, by opening the control circuit. Withdrawal of key by opening the mobile protector, causes immediate

stopping of the machine drive.
Specific limit switches ideal for monitoring and protection of light industrial machines without inertia, equipped with angular movement protectors (doors, hinges, rotative covers, grid, etc.).
Detection by the rotative axis or by means of a lever. Opening of the mobile protector guarantees operator protection by immediately stopping the machine drive.
To control the access point of the hazardous area.

Ordering Key

PS21S-PS1105-T00

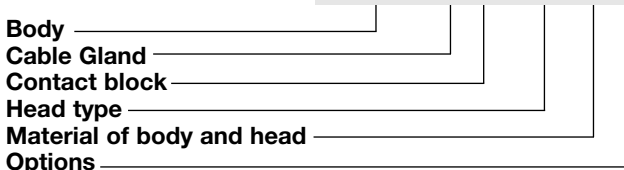

Description of the key codes

for Key actuator (key must be ordered separately) Hinge and Wire					
PS21S	P	S11	05	T	00
PS42S	N	S02	09	Y	
PS21H	B	T11	HZ		
PS42H	A	O11	HS		
	M	T02	HC		
PS21R			N6		
PS42R			N7		K0 ⁴

for Key actuator (key must be ordered separately) and Wire					
PS31S	P	S11	05	Y	00
PS43S	N	S02		T ⁵	
	M	T11			
PS31R		O11	N7		
PS43R		T02	N7		K0 ⁴
		T21			
		T12			
		T03			

Cable Gland

M	M20
P	PG13.5
B	PG11
A	M16
N	1/2 NPT

Contact block

O11	1NO+1NC overlap slow(+)
S02	2NC snap(+)
S11	1NO+1NC snap(+)
T02	2NC slow(+)
T03	3NC slow(+)
T11	1NO+1NC slow(+)
T12	1NO+2NC slow(+)
T21	2NO+1NC slow(+)

Material of body and head

T	Thermoplastic Body and Thermoplastic head
Y	Metal Body and Thermoplastic head

Body

PS21H	PS 30mm/1.18" (fix 20/22mm/0.79"/0.87") 1 cable inlet for hinge (shaft or pin)
PS42H	PS 50mm/1.97" (fix 40/42mm/1.57"/1.65") 2 cable inlet for hinge (shaft or pin)
PS21R	PS 30mm/1.18" (fix 20/22mm/0.79"/0.87") 1 cable inlet for pull wire
PS31R	PS 40mm/1.57" (fix 30mm/1.18") 1 cable inlet for pull wire
PS42R	PS 50mm/1.97" (fix 40/42mm/1.57"/1.65") 2 cable inlet for pull wire
PS43R	PS 60mm/2.36" (fix 40/42mm/1.57"/1.65") 3 cable inlet for pull wire
PS21S	PS 30mm/1.18" (fix 20/22mm/0.79"/0.87") 1 cable inlet for Key actuator
PS31S	PS 40mm/1.57" (fix 30mm/1.18") 1 cable inlet for Key actuator
PS42S	PS 50mm/1.97" (fix 40/42mm/1.57"/1.65") 2 cable inlet for Key actuator
PS43S	PS 60mm/2.36" (fix 40/42mm/1.57"/1.65") 3 cable inlet for Key actuator

Head type

05	90° Adj. key head
09	Fully turnable key head
HC	Zinc plated steel LEVER
HS	Stainless steel shaft
HZ	Zinc plated steel shaft
N6	Pull wire for simple stop
N7	Pull wire for emergency stop

Options

00	no option
K0	with reset button

Technical Data

	Plastic Body	Metal body
Standards	IEC 60947-1, IEC 60947-5-1, EN 60947-1, EN 60947-5-1, UL508 and CSA C22-2 n°14	
Certifications – Approvals	UL – CSA	
Air temperature near the device - during operation - for storage	-25°C...+70°C/-13°F...158°F -30°C...+80°C/-22°F...+176°F	
Climatic withstand	According to IEC 68-2-3 and salty mist according to IEC 68-2-11	
Mounting positions	All positions are authorized	
Shock withstand (according to IEC 68-2-27 and 60068-2-27) (1/2 sinusoidal shock for 11ms) no change in contact position	10g/0.35oz Limit switch with key actuator 40g/1.41oz Limit switch for hinge (pin/shaft) or pull wire (rope)	
Protection against electrical shocks (according to IEC 536)	Class II	Class I
Degree of protection (according to IEC 529 and EN 60529)	IP65	IP66

Electrical Data

	Plastic Body	Metal body
Rated insulation voltage U_i -according to IEC 60947-1 and EN 60947-1	500V (degree of pollution 3)	400V (PS21,PS42), 500V (PS31,PS43) (degree of pollution 3)
-according to UL 508, CSA C22-2 n°14	A 600 Q600	A 300 Q 300 (PS21, PS42) A 600 Q 600 (PS31, PS43)
Rated impulse withstand voltage U_{imp} (according to IEC 60947-1 and EN 60947-1)	6kV	
Conventional enclosed thermal current I_{the} (according to IEC 60947-1 and EN 60947-5-1) ($\theta \leq 40^\circ\text{C}$)	10A	
Short-circuit protection - gG type fuses	10A	
Rated operational current		
I_e / AC-15 - acc.to IEC 60947-5-1	24VAC (50/60 Hz) 130VAC (50/60 Hz) 230VAC (50/60 Hz) 240VAC (50/60 Hz) 400VAC (50/60 Hz)	10.0A 5.5A 3.1A 3.0A 1.8A
- acc.to UL 508, CSA C22 n°14	Q 600	Q 300 (PS21/42) Q 600 (PS31/43)
I_e / DC-13 - acc.to IEC 60947-5-1	24VDC 110VDC 250VDC	2.8A 0.6A 0.27A
- acc.to UL 508, CSA C22 n°14	Q 600	Q 300 (PS21/42) Q 600 (PS31/43)
Electrical durability (according to IEC 60497-5-1 annex C) - max. switching frequency Cycles/h - load factor	Utilization categories AC-15 and DC-13 (see curves and value below) 3600 0.5	
Connecting data of contact blocks Connecting terminals Connecting capacity 1 or 2 x mm ² / AWG Terminal marking	M3.5 (+,-) pozidriv 2 screw with cable clamp 0.5mm² / AWG 20 to 2.5mm² / AWG 14 According to EN 50013	
Positivity	Contacts with positive opening operation as per IEC 60947-5-1 chapter 3	

Diagram for snap action contact:

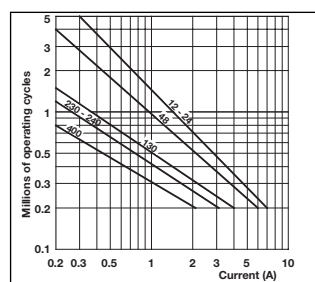
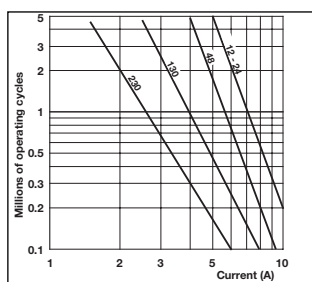

Diagram for slow action contact:



Electrical durability for DC-13 utilization category

Power breaking for a durability of 5 million operating cycles		
	Snap action	Slow action
Voltage 24V	9.5W	12W
Voltage 48V	6.8W	9W
Voltage 110V	3.6W	6W

Limit Switches - Limit Type (PS21S/H/R) Plastic Body IP65



● Cable Gland

- P** = one cable inlet PG13.5 cable gland
- M** = one cable inlet M20x1.5 cable gland
- N** = one cable inlet 1/2" NPT cable gland
- B** = one cable inlet PG11 cable gland
- A** = one cable inlet M16x1.5 cable gland

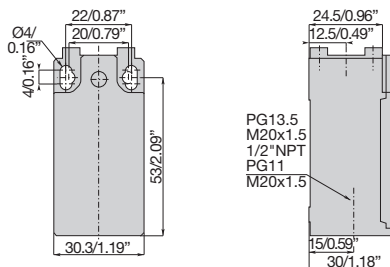

▲ Contact block (Zb type)

S11 (1NO+1NC) Snap Action		T11 (1NO+1NC) Non overlapping Slow action		O11 (1NO+1NC) Overlapping Slow Action	
T02 (2NC) Slow Action		S02 (2NC) Snap Action			

		S11	T11	O11
		T02	S02	

Conformity / (NC)	EN 50047 / (NC)	90° adjustable head	
Max. Actuation speed	0.5m/s / 1.64ft/s	Code	PS21S-●▲05-T00
Min. force or torque	15N / 30Nm		
Weight	78.0g / 2.751oz		

		S11	T11	O11
		T02	S02	

Conformity / (NC)	EN 50047 / (NC)	Fully turnable head	
Max. Actuation speed	0.5m/s / 1.64ft/s	Code	PS21S-●▲09-T00
Min. force or torque	15N / 30Nm		
Weight	99.0g / 3.492oz		

		S11	T11	O11
		T02	S02	

Conformity / (NC)	EN 50047 / (NC)	Shaft for hinge	
Max. Actuation speed	0.5m/s / 1.64ft/s	Code Zinc plated steel	PS21H-●▲HZ-T00
Min. force or torque	0.12N / 0.60Nm	Stainless steel	PS21H-●▲HS-T00
Weight	98.0g / 3.457oz		

		S11	T11	O11
		T02	S02	

Conformity / (NC)	EN 50047 / (NC)	Zinc plated steel lever	
Max. Actuation speed	0.5m/s / 1.64ft/s	Code	PS21H-●▲HC-T00
Min. force or torque	0.12N / 0.60Nm		
Weight	117.0g / 4.127oz		

			S11 	T11 	O11
			T02 	S02 	

Conformity / (NC)	- / (NC)	Pull wire without reset for simple stop	
Max. Actuation speed	-	Code	PS21R- N6-T00
Max wire length	6m/19.68ft ÷ 15m/49.21ft		
Weight	130.0g / 4.586oz		

			S11 	T11 	O11
			T02 	S02 	

Conformity / (NC)	EN 50047 / (NC)	Pull wire with reset for emergency stop	
Max. Actuation speed	-	Code	PS21R- N7-TK0
Max wire length	6m/19.68ft ÷ 15m/49.21ft		
Weight	135.0g / 4.762oz		

Operating Key

K13 Bent Key 22mm/0.87"	K14 Flat Key 22mm/0.87"	K15 Bent Key 13mm/0.51"	K16 Flat Key 13mm/0.51"	K17 Shock absorbing bent key	K18 Shock absorbing flat key	K19 Adjustable joint key

Accessories for Pull Wire Limit Switches

OCC 8 Stay Bolt	MOR 05 Rope Clamp	RED 05 Rope Eye	FUN 05 Rope 5mm x 100m 0.20" x 328.08ft

Limit Switches - Safety Type (PS42S/H/R) Plastic Body IP65



● Cable Gland

- P = one cable inlet PG13.5 cable gland
- M = one cable inlet M20x1.5 cable gland
- N = one cable inlet 1/2" NPT cable gland
- B = one cable inlet PG11 cable gland
- A = one cable inlet M16x1.5 cable gland

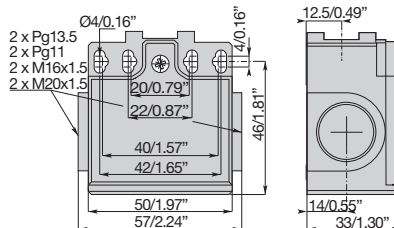

▲ Contact block (Zb type)

S11 (1NO+1NC) Snap Action		T11 (1NO+1NC) Non overlapping Slow action		O11 (1NO+1NC) Overlapping Slow Action	
T02 (2NC) Slow Action		S02 (2NC) Snap Action			

		S11	T11	O11
		T02	S02	

Conformity / (NC)	EN 50047 / (C)	90° adjustable head	
Max. Actuation speed	0.5m/s / 1.64ft/s	Code	PS42S-●▲05-T00
Min. force or torque	15N / 30Nm		
Weight	114.0g / 4.021oz		

		S11	T11	O11
		T02	S02	

Conformity / (NC)	EN 50047 / (C)	Fully turnable head	
Max. Actuation speed	0.5m/s / 1.64ft/s	Code	PS42S-●▲09-T00
Min. force or torque	15N / 30Nm		
Weight	125.0g / 4.409oz		

		S11	T11	O11
		T02	S02	

Conformity / (NC)	EN 50047 / (C)	Shaft for hinge	
Max. Actuation speed	0.5m/s / 1.64ft/s	Code	Zinc plated steel Stainless steel
Min. force or torque	0.12N / 0.60Nm		PS42H-●▲HZ-T00 PS42H-●▲HS-T00
Weight	128.0g / 4.515oz		

		S11	T11	O11
		T02	S02	

Conformity / (NC)	EN 50047 / (C)	Zinc plated steel lever	
Max. Actuation speed	0.5m/s / 1.64ft/s	Code	PS42H-●▲HC-T00
Min. force or torque	0.12N / 0.60Nm		
Weight	152.0g / 5.362oz		

			S11	T11	O11
			T02	S02	

Conformity / (NC)	- / (NC)	Pull wire without reset for simple stop	
Max. Actuation speed	-	Code	PS42R- N6-T00
Max wire length	6m/19.68ft ÷ 15m/49.21ft		
Weight	158.0g / 5.573oz		

			S11	T11	O11
			T02	S02	

Conformity / (NC)	EN 50047 / (NC)	Pull wire with reset for emergency stop	
Max. Actuation speed	-	Code	PS42R- N7-TK0
Max wire length	6m/19.68ft ÷ 15m/49.21ft		
Weight	163.0g / 5.750oz		

Operating Key

K13 Bent Key 22mm/0.87"	K14 Flat Key 22mm/0.87"	K15 Bent Key 13mm/0.51"	K16 Flat Key 13mm/0.51"	K17 Shock absorbing bent key	K18 Shock absorbing flat key	K19 Adjustable joint key

Accessories for Pull Wire Limit Switches

OCC 8 Stay bolt	MOR 05 Rope Clamp	RED 05 Rope Eye	FUN 05 Rope 5mm x 100m 0.20" x 328.08ft

Limit Switches - Safety Type (PS31S) plastic Body IP65



● Cable Gland

- P = one cable inlet PG13.5 cable gland
- M = one cable inlet M20x1.5 cable gland
- N = one cable inlet 1/2" NPT cable gland

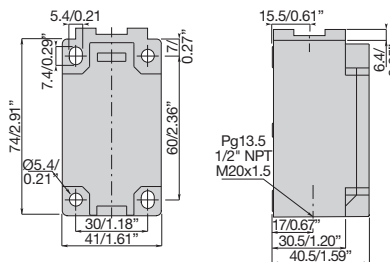

▲ Contact block (Zb type)

S11 (1NO+1NC) Snap action		T11 (1NO+1NC) Non overlapping Slow action		O11 (1NO+1NC) Overlapping Slow action		T02 (2NC) Slow Action	
S02 (2NC) Snap action		T12 (1NO+2NC) Non overlapping Slow action		T21 (2NO+1NC) Non overlapping Slow action		T03 (3NC) Simultaneous Slow action	

		S11	T11	O11	T02
		S02	T12	T21	T03

Conformity (↗) (NC)	EN 50041 (↗)	Key operated 90° adjustable head	
Max. Actuation speed	0.5m/s / 1.64ft/s	Code	PS31S-●▲05-T00
Min. force or torque	30N / 45Nm		
Weight	158.0g / 5.573oz		

Operating Key

K35 Bent Key 13mm/0.51"	K36 Flat Key 13mm/0.51"	K39 Adjustable Joint Key



Limit Switches - Safety Type (PS21S/H/R) Metal Body IP66



● Cable Gland

- P** = one cable inlet PG13.5 cable gland
- M** = one cable inlet M20x1.5 cable gland
- N** = one cable inlet 1/2" NPT cable gland
- B** = one cable inlet PG11 cable gland
- A** = one cable inlet M16x1.5 cable gland

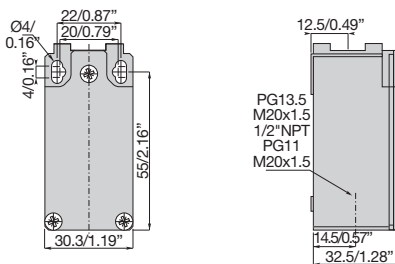

▲ Contact block (Zb type)

S11 (1NO+1NC) Snap Action		T11 (1NO+1NC) Non overlapping Slow action		O11 (1NO+1NC) Overlapping Slow Action	
T02 (2NC) Slow Action		S02 (2NC) Snap Action			

		S11	T11	O11
		T02	S02	

Conformity / (NC)	EN 50047 / (NC)	90° adjustable head	
Max. Actuation speed	0.5m/s / 1.64ft/s	Code	PS21S-●▲05-Y00
Min. force or torque	15N / 30Nm		
Weight	177.0g / 6.243oz		

		S11	T11	O11
		T02	S02	

Conformity / (NC)	EN 50047 / (NC)	Fully turnable head	
Max. Actuation speed	0.5m/s / 1.64ft/s	Code	PS21S-●▲09-Y00
Min. force or torque	15N / 30Nm		
Weight	195.0g / 6.878oz		

		S11	T11	O11
		T02	S02	

Conformity / (NC)	EN 50047 / (NC)	Shaft for hinge	
Max. Actuation speed	0.5m/s / 1.64ft/s	Code	Zinc plated steel Stainless steel
Min. force or torque	0.12N / 0.60Nm		PS21H-●▲HZ-Y00 PS21H-●▲HS-Y00
Weight	195.0g / 6.878oz		

		S11	T11	O11
		T02	S02	

Conformity / (NC)	EN 50047 / (NC)	Zinc plated steel lever	
Max. Actuation speed	0.5m/s / 1.64ft/s	Code	PS21H-●▲HC-Y00
Min. force or torque	0.12N / 0.60Nm		
Weight	213.0g / 7.513oz		

			S11	T11	O11
			T02	S02	

Conformity / (NC)	- /	Pull wire without reset for simple stop	
Max. Actuation speed	-	Code	PS21R- N6-Y00
Max wire length	6m/19.68ft ÷ 15m/49.21ft		
Weight	226.0g / 7.972oz		

			S11	T11	O11
			T02	S02	

Conformity / (NC)	EN 50047 /	Pull wire with reset for emergency stop	
Max. Actuation speed	-	Code	PS21R- N7-YK0
Max wire length	6m/19.68ft ÷ 15m/49.21ft		
Weight	231.0g / 8.148oz		

Operating Key

K13 Bent Key 22mm/0.87"	K14 Flat Key 22mm/0.87"	K15 Bent Key 13mm/0.51"	K16 Flat Key 13mm/0.51"	K17 Shock absorbing bent key	K18 Shock absorbing flat key	K19 Adjustable joint key

Accessories for Pull Wire Limit Switches

OCC 8 Stay bolt	MOR 05 Rope Clamp	RED 05 Rope Eye	FUN 05 Rope 5mm x 100m 0.20" x 328.08ft

Limit Switches - Safety Type (PS42S/H/R) Metal Body IP66



● Cable Gland

- P = one cable inlet PG13.5 cable gland
- M = one cable inlet M20x1.5 cable gland
- N = one cable inlet 1/2" NPT cable gland
- B = one cable inlet PG11 cable gland
- A = one cable inlet M16x1.5 cable gland

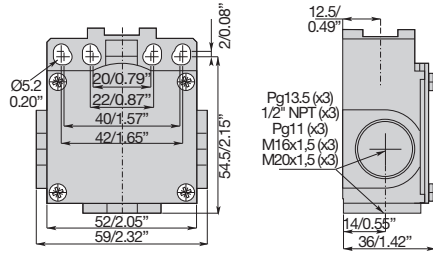

▲ Contact block (Zb type)

S11 (1NO+1NC) Snap Action		T11 (1NO+1NC) Non overlapping Slow action		O11 (1NO+1NC) Overlapping Slow Action	
T02 (2NC) Slow Action		S02 (2NC) Snap Action			

		S11	T11	O11
		T02	S02	

Conformity / (NC)	EN 50047 / (C)	90° adjustable head	
Max. Actuation speed	0.5m/s / 1.64ft/s	Code	PS42S-●▲05-Y00
Min. force or torque	15N / 30Nm		
Weight	285.0g / 10.053oz		

		S11	T11	O11
		T02	S02	

Conformity / (NC)	EN 50047 / (C)	Fully turnable head	
Max. Actuation speed	0.5m/s / 1.64ft/s	Code	PS42S-●▲09-Y00
Min. force or torque	15N / 30Nm		
Weight	296.0g / 10.441oz		

		S11	T11	O11
		T02	S02	

Conformity / (NC)	EN 50047 / (C)	Shaft for hinge	
Max. Actuation speed	0.5m/s / 1.64ft/s	Code	Zinc plated steel Stainless steel
Min. force or torque	0.12N / 0.60Nm		PS42H-●▲HZ-Y00 PS42H-●▲HS-Y00
Weight	297.0g / 10.476oz		

		S11	T11	O11
		T02	S02	

Conformity / (NC)	EN 50047 / (C)	Zinc plated steel lever	
Max. Actuation speed	0.5m/s / 1.64ft/s	Code	PS42H-●▲HC-Y00
Min. force or torque	0.12N / 0.60Nm		
Weight	297.0g / 10.476oz		

			S11	T11	O11
			T02	S02	

Conformity / (NC)	- / (NC)	Pull wire without reset for simple stop	
Max. Actuation speed	-	Code	PS42R- N6-Y00
Max wire length	6m/19.68ft ÷ 15m/49.21ft		
Weight	292.0g / 10.300oz		

			S11	T11	O11
			T02	S02	

Conformity / (NC)	EN 50047 / (NC)	Pull wire with reset for emergency stop	
Max. Actuation speed	-	Code	PS42R- N7-YK0
Max wire length	6m/19.68ft ÷ 15m/49.21ft		
Weight	297.0g / 10.476oz		

Operating Key

K13 Bent Key 22mm/0.87"	K14 Flat Key 22mm/0.87"	K15 Bent Key 13mm/0.51"	K16 Flat Key 13mm/0.51"	K17 Shock absorbing bent key	K18 Shock absorbing flat key	K19 Adjustable joint key

Accessories for Pull Wire Limit Switches

OCC 8 Stay bolt	MOR 05 Rope Clamp	RED 05 Rope Eye	FUN 05 Rope 5mm x 100m 0.20" x 328.08ft

Limit Switches - Safety Type (PS31S/R) Metal Body IP66



● Cable Gland

- P = one cable inlet PG13.5 cable gland
- M = one cable inlet M20x1.5 cable gland
- N = one cable inlet 1/2" NPT cable gland

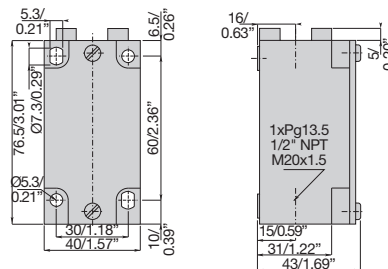

▲ Contact block (Zb type)

S11 (1NO+1NC) Snap action		T11 (1NO+1NC) Non overlapping Slow action		O11 (1NO+1NC) Overlapping Slow action		T02 (2NC) Slow Action	
S02 (2NC) Snap action		T12 (1NO+2NC) Non overlapping Slow action		T21 (2NO+1NC) Non overlapping Slow action		T03 (3NC) Simultaneous Slow action	

		S11	T11	O11	T02
		S02	T12	T21	T03

Conformity / (NC)	EN 50041 / (NC)	Key operated 90° adjustable head
Max. Actuation speed	0.5m/s / 1.64ft/s	Code
Min. force or torque	30N / 45Nm	PS31S-●▲05-Y00
Weight	210.0g / 7.408oz	

		S11	T11	O11	T02
		S02	T12	T21	T03

Conformity / (NC)	EN 50041 / (NC)	Pull wire without reset for simple stop
Max. Actuation speed	0.5m/s / 1.64ft/s	Code
Min. force or torque	16m/52.49ft ÷ 25m/82.02ft	PS31R-●▲N7-Y00
Weight	268.0g / 9.453oz	

		S11	T11	O11	T02
		S02	T12	T21	T03

Conformity / (NC)	EN 50041 / (NC)	Pull wire with reset for emergency stop
Max. Actuation speed	0.5m/s / 1.64ft/s	Code
Min. force or torque	16m/52.49ft ÷ 25m/82.02ft	PS31R-●▲N7-YK0
Weight	270.0g / 9.524oz	

Operating Key

K35 Bent Key 13mm/0.51"		K36 Flat Key 13mm/0.51"		K39 Adjustable Joint Key	

Limit Switches - Safety Type (PS43S/R) Metal Body IP66



● Cable Gland

- P = one cable inlet PG13.5 cable gland
- M = one cable inlet M20x1.5 cable gland
- N = one cable inlet 1/2" NPT cable gland

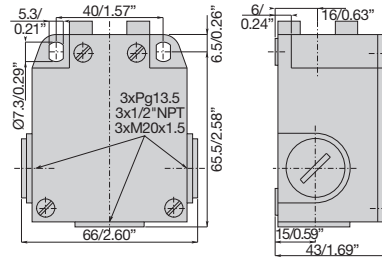

▲ Contact block (Zb type)

S11 (1NO+1NC) Snap action	T11 (1NO+1NC) Non overlapping Slow action	O11 (1NO+1NC) Overlapping Slow action	T02 (2NC) Slow Action
S02 (2NC) Snap action	T12 (1NO+2NC) Non overlapping Slow action	T21 (2NO+1NC) Non overlapping Slow action	T03 (3NC) Simultaneous Slow action

		S11	T11	O11	T02
		S02	T12	T21	T03

Conformity / (NC)	EN 50041 / (NC)	Key operated 90° adjustable head
Max. Actuation speed	0.5m/s / 1.64ft/s	Code
Min. force or torque	14N / 40Nm	PS43S-●▲05-Y00
Weight	227.0g / 8.007oz	

		S11	T11	O11	T02
		S02	T12	T21	T03

Conformity / (NC)	EN 50041 / (NC)	Pull wire without reset for simple stop
Max. Actuation speed	0.5m/s / 1.64ft/s	Code
Min. force or torque	16m/52.49ft ÷ 25m/82.02ft	PS43R-●▲N7-Y00
Weight	270.0g / 9.524oz	

		S11	T11	O11	T02
		S02	T12	T21	T03

Conformity / (NC)	EN 50041 / (NC)	Pull wire with reset for emergency stop
Max. Actuation speed	0.5m/s / 1.64ft/s	Code
Min. force or torque	16m/52.49ft ÷ 25m/82.02ft	PS43R-●▲N7-YK0
Weight	274.0g / 9.665oz	

Operating Key

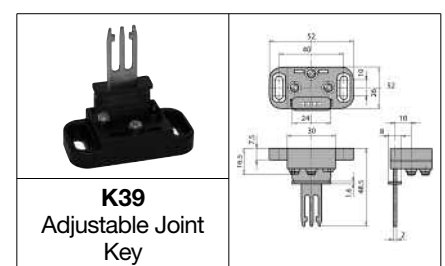
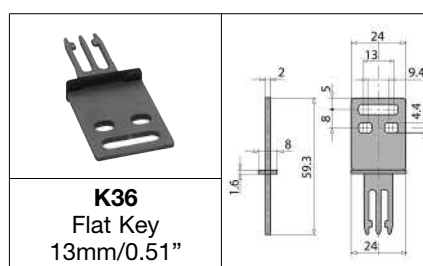
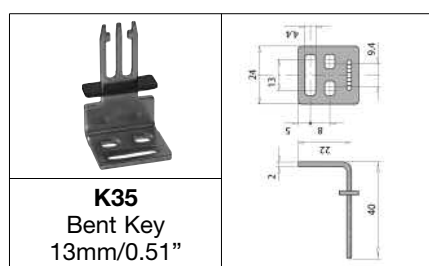

Utilization precautions

Maximum lenght application of pullwire head



PS21, PS42: 6m/19.70ft max.
PS31, PS43: 16m/52.49ft max.

PS21, PS42: 15m/49.21ft max.
PS31, PS43: 25m/82.02ft max.

Example of applications

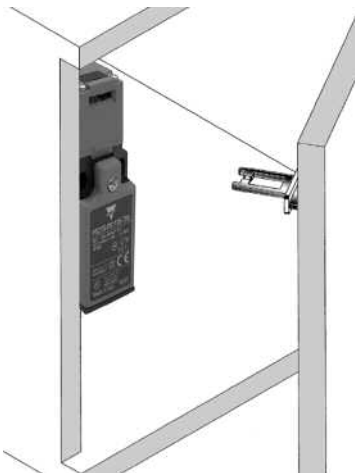

Key actuator type

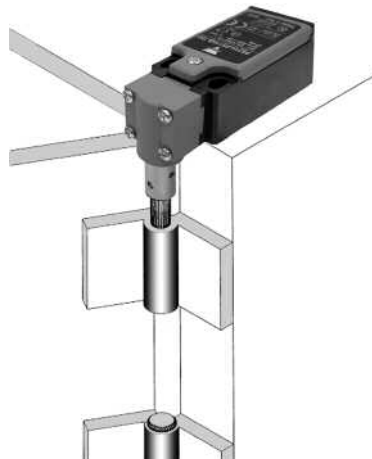

Head for hinge (by pin)



Head for hinge (by shaft)

Adjustment

5 way key actuator head



Accessories for Pull Wire Limit Switches

			
OCC 8 Stay bolt	MOR 05 Rope Clamp	RED 05 Rope Eye	FUN 05 Rope 5mmx100m 0.20" x 328.08ft