



MRF89XAMxA PICtail™/PICtail Plus
Daughter Board User's Guide

Note the following details of the code protection feature on Microchip devices:

- Microchip products meet the specification contained in their particular Microchip Data Sheet.
- Microchip believes that its family of products is one of the most secure families of its kind on the market today, when used in the intended manner and under normal conditions.
- There are dishonest and possibly illegal methods used to breach the code protection feature. All of these methods, to our knowledge, require using the Microchip products in a manner outside the operating specifications contained in Microchip's Data Sheets. Most likely, the person doing so is engaged in theft of intellectual property.
- Microchip is willing to work with the customer who is concerned about the integrity of their code.
- Neither Microchip nor any other semiconductor manufacturer can guarantee the security of their code. Code protection does not mean that we are guaranteeing the product as "unbreakable."

Code protection is constantly evolving. We at Microchip are committed to continuously improving the code protection features of our products. Attempts to break Microchip's code protection feature may be a violation of the Digital Millennium Copyright Act. If such acts allow unauthorized access to your software or other copyrighted work, you may have a right to sue for relief under that Act.

Information contained in this publication regarding device applications and the like is provided only for your convenience and may be superseded by updates. It is your responsibility to ensure that your application meets with your specifications. MICROCHIP MAKES NO REPRESENTATIONS OR WARRANTIES OF ANY KIND WHETHER EXPRESS OR IMPLIED, WRITTEN OR ORAL, STATUTORY OR OTHERWISE, RELATED TO THE INFORMATION, INCLUDING BUT NOT LIMITED TO ITS CONDITION, QUALITY, PERFORMANCE, MERCHANTABILITY OR FITNESS FOR PURPOSE. Microchip disclaims all liability arising from this information and its use. Use of Microchip devices in life support and/or safety applications is entirely at the buyer's risk, and the buyer agrees to defend, indemnify and hold harmless Microchip from any and all damages, claims, suits, or expenses resulting from such use. No licenses are conveyed, implicitly or otherwise, under any Microchip intellectual property rights.

Trademarks

The Microchip name and logo, the Microchip logo, dsPIC, KEELOQ, KEELOQ logo, MPLAB, PIC, PICmicro, PICSTART, PIC³² logo, rPIC and UNI/O are registered trademarks of Microchip Technology Incorporated in the U.S.A. and other countries.

FilterLab, Hampshire, HI-TECH C, Linear Active Thermistor, MXDEV, MXLAB, SEEVAL and The Embedded Control Solutions Company are registered trademarks of Microchip Technology Incorporated in the U.S.A.

Analog-for-the-Digital Age, Application Maestro, CodeGuard, dsPICDEM, dsPICDEM.net, dsPICworks, dsSPEAK, ECAN, ECONOMONITOR, FanSense, HI-TIDE, In-Circuit Serial Programming, ICSP, Mindi, MiWi, MPASM, MPLAB Certified logo, MPLIB, MPLINK, mTouch, Omniscient Code Generation, PICC, PICC-18, PICDEM, PICDEM.net, PICkit, PICtail, REAL ICE, rLAB, Select Mode, Total Endurance, TSHARC, UniWinDriver, WiperLock and ZENA are trademarks of Microchip Technology Incorporated in the U.S.A. and other countries.

SQTP is a service mark of Microchip Technology Incorporated in the U.S.A.

All other trademarks mentioned herein are property of their respective companies.

© 2011, Microchip Technology Incorporated, Printed in the U.S.A., All Rights Reserved.

 Printed on recycled paper.

ISBN: 978-1-60932-846-7

Microchip received ISO/TS-16949:2002 certification for its worldwide headquarters, design and wafer fabrication facilities in Chandler and Tempe, Arizona, Gresham, Oregon and design centers in California and India. The Company's quality system processes and procedures are for its PIC® MCUs and dsPIC® DSCs, KEELOQ® code hopping devices, Serial EEPROMs, microperipherals, nonvolatile memory and analog products. In addition, Microchip's quality system for the design and manufacture of development systems is ISO 9001:2000 certified.

**QUALITY MANAGEMENT SYSTEM
CERTIFIED BY DNV
== ISO/TS 16949:2002 ==**



MRF89XAMxA PICtail™/PICtail PLUS DAUGHTER BOARD USER'S GUIDE

Table of Contents

Preface	5
Chapter 1. Overview	
1.1 Introduction	11
1.2 MRF89XAMxA PICtail/PICtail Plus Daughter Board Contents	11
1.3 MRF89XAMxA PICtail/PICtail Plus Daughter Board	11
Chapter 2. Getting Started	
2.1 Introduction	15
2.2 Plugging into the PIC18 Explorer Board	15
2.3 Plugging into the Explorer 16 Development Board	16
2.4 Downloading and Running the Demo Program	17
Appendix A. MRF89XAMxA PICtail/PICtail Plus Daughter Board Schematic	
A.1 Introduction	19
A.2 MRF89XAMxA PICtail/PICtail Plus Daughter Board Schematic	20
A.3 MRF89XAMxA PICtail/PICtail Plus Daughter Board PCB Layout	21
A.4 MRF89XAMxA PICtail/PICtail Plus Daughter Board Bill of Materials	23
Worldwide Sales and Service	24

MRF89XAMxA PICtail™/PICtail Plus Daughter Board User's Guide

NOTES:



MRF89XAMxA PICtail™/PICtail PLUS DAUGHTER BOARD USER'S GUIDE

Preface

NOTICE TO CUSTOMERS

All documentation becomes dated, and this manual is no exception. Microchip tools and documentation are constantly evolving to meet customer needs, so some actual dialogs and/or tool descriptions may differ from those in this document. Please refer to our web site (www.microchip.com) to obtain the latest documentation available.

Documents are identified with a “DS” number. This number is located on the bottom of each page, in front of the page number. The numbering convention for the DS number is “DSXXXXA”, where “XXXX” is the document number and “A” is the revision level of the document.

For the most up-to-date information on development tools, see the MPLAB® IDE on-line help. Select the Help menu, and then Topics to open a list of available on-line help files.

INTRODUCTION

This chapter contains general information that will be useful to know before using the MRF89XAMxA PICtail™/PICtail Plus Daughter Board. Items discussed in this chapter include:

- Document Layout
- Conventions Used in this Guide
- Warranty Registration
- Recommended Reading
- The Microchip Web Site
- Development Systems Customer Change Notification Service
- Customer Support
- Document Revision History

DOCUMENT LAYOUT

This document describes how to use the MRF89XAMxA PICtail™/PICtail Plus Daughter Board. The manual layout is as follows:

- **Chapter 1. “Overview”** This chapter provides an overview of the MRF89XAMxA PICtail/PICtail Plus Daughter Board, including board contents and features.
- **Chapter 2. “Getting Started”** This chapter describes how to start using your MRF89XAMxA PICtail/PICtail Plus Daughter Board.
- **Appendix A. “MRF89XAMxA PICtail/PICtail Plus Daughter Board Schematic”** This appendix contains the schematics, PCB information and Bill of Materials for the MRF89XAMxA PICtail/PICtail Plus Daughter Board.

CONVENTIONS USED IN THIS GUIDE

This manual uses the following documentation conventions:

DOCUMENTATION CONVENTIONS

Description	Represents	Examples
Arial font:		
Italic characters	Referenced books	<i>MPLAB® IDE User's Guide</i>
	Emphasized text	...is the <i>only</i> compiler...
Initial caps	A window	the Output window
	A dialog	the Settings dialog
	A menu selection	select Enable Programmer
Quotes	A field name in a window or dialog	"Save project before build"
Underlined, italic text with right angle bracket	A menu path	<u><i>File>Save</i></u>
Bold characters	A dialog button	Click OK
	A tab	Click the Power tab
N'Rnnnn	A number in verilog format, where N is the total number of digits, R is the radix and n is a digit.	4'b0010, 2'hF1
Text in angle brackets < >	A key on the keyboard	Press <Enter>, <F1>
Courier New font:		
Plain Courier New	Sample source code	#define START
	Filenames	autoexec.bat
	File paths	c:\mcc18\h
	Keywords	_asm, _endasm, static
	Command-line options	-Opa+, -Opa-
	Bit values	0, 1
	Constants	0xFF, 'A'
Italic Courier New	A variable argument	<i>file.o</i> , where <i>file</i> can be any valid filename
Square brackets []	Optional arguments	mcc18 [options] <i>file</i> [options]
Curly brackets and pipe character: { }	Choice of mutually exclusive arguments; an OR selection	errorlevel {0 1}
Ellipses...	Replaces repeated text	var_name [, var_name...]
	Represents code supplied by user	void main (void) { ... }

WARRANTY REGISTRATION

Please complete the enclosed Warranty Registration Card and mail it promptly. Sending in the Warranty Registration Card entitles users to receive new product updates. Interim software releases are available at the Microchip web site.

RECOMMENDED READING

This user's guide describes how to use the MRF89XAMxA PICtail/PICtail Plus Daughter Board. Other useful documents are listed below. The following Microchip documents are available and recommended as supplemental reference resources.

MRF89XA Ultra Low-Power Integrated ISM Band Sub-GHz Transceiver (DS70622)

MRF89XAM8A 868 MHz Ultra Low- Power Sub-GHz Transceiver Module Data Sheet (DS70651)

PICDEM™ PIC18 Explorer Demonstration Board User's Guide (DS51721)

Explorer 16 Development Board User's Guide (DS51589)

2K SPI Bus Serial EEPROM with EUI-48™ Node Identity Data Sheet (DS22123)

THE MICROCHIP WEB SITE

Microchip provides online support via our web site at www.microchip.com. This web site is used as a means to make files and information easily available to customers. Accessible by using your favorite Internet browser, the web site contains the following information:

- **Product Support** – Data sheets and errata, application notes and sample programs, design resources, user's guides and hardware support documents, latest software releases and archived software
- **General Technical Support** – Frequently Asked Questions (FAQs), technical support requests, online discussion groups, Microchip consultant program member listing
- **Business of Microchip** – Product selector and ordering guides, latest Microchip press releases, listing of seminars and events, listings of Microchip sales offices, distributors and factory representatives

DEVELOPMENT SYSTEMS CUSTOMER CHANGE NOTIFICATION SERVICE

Microchip's customer notification service helps keep customers current on Microchip products. Subscribers will receive e-mail notification whenever there are changes, updates, revisions or errata related to a specified product family or development tool of interest.

To register, access the Microchip web site at www.microchip.com, click on Customer Change Notification and follow the registration instructions.

The Development Systems product group categories are:

- **Compilers** – The latest information on Microchip C compilers and other language tools. These include the MPLAB C18 and MPLAB C30 C compilers; MPASM™ and MPLAB ASM30 assemblers; MPLINK™ and MPLAB LINK30 object linkers; and MPLIB™ and MPLAB LIB30 object librarians.
- **Emulators** – The latest information on Microchip in-circuit emulators. This includes the MPLAB ICE 2000 and MPLAB ICE 4000.
- **In-Circuit Debuggers** – The latest information on the Microchip in-circuit debugger, MPLAB ICD 2.
- **MPLAB® IDE** – The latest information on Microchip MPLAB IDE, the Windows® Integrated Development Environment for development systems tools. This list is focused on the MPLAB IDE, MPLAB SIM simulator, MPLAB IDE Project Manager and general editing and debugging features.
- **Programmers** – The latest information on Microchip programmers. These include the MPLAB PM3 and PRO MATE II device programmers and the PICSTART® Plus and PICKit™ 1, 2, and 3 development programmers.

CUSTOMER SUPPORT

Users of Microchip products can receive assistance through several channels:

- Distributor or Representative
- Local Sales Office
- Field Application Engineer (FAE)
- Technical Support

Customers should contact their distributor, representative or field application engineer (FAE) for the support. Local sales offices are also available to help customers. A listing of sales offices and locations is included in the back of this document.

Technical support is available through the web site at: <http://support.microchip.com>

DOCUMENT REVISION HISTORY

Revision A (January 2011)

- This is the initial release of the document.

Chapter 1. Overview

1.1 INTRODUCTION

The MRF89XAMxA PICtail™/PICtail Plus Daughter Board is a demonstration and development daughter board for the following modules:

- MRF89XAM8A Ultra Low-Power Sub-GHz Transceiver Module - 868 MHz (AC164138-1)
- MRF89XAM9A Ultra Low-Power Sub-GHz Transceiver Module - 915 MHz (AC164138-2)

The daughter board can be plugged into multiple Microchip Technology demonstration and development boards. For example, the daughter board is appropriate for 8-bit microcontroller development using the PIC18 Explorer Board (DM183032) or for 16-bit or 32-bit microcontroller development using the Explorer 16 Development Board (DM240001).

Supporting software stacks and application notes can be downloaded from the Microchip website <http://www.microchip.com/wireless>.

This chapter discusses these topics:

- MRF89XAMxA PICtail/PICtail Plus Daughter Board Contents
- MRF89XAMxA PICtail/PICtail Plus Daughter Board

1.2 MRF89XAMxA PICtail/PICtail PLUS DAUGHTER BOARD CONTENTS

Depending on the development tool ordered, package will contain one of the following development boards listed in Table 1-1.

TABLE 1-1: MRF89XAMxA PICtail™/PICtail PLUS DAUGHTER BOARD

Description	Part Number
MRF89XAM8A PICtail/PICtail Plus Daughter Board – 868 MHz	AC164138-1
MRF89XAM9A PICtail/PICtail Plus Daughter Board – 915 MHz	AC164138-2

1.3 MRF89XAMxA PICtail/PICtail PLUS DAUGHTER BOARD

The MRF89XAMxA PICtail/PICtail Plus Daughter Board is a complete Ultra Low-Power Sub-GHz wireless transceiver. The features are shown in Figure 1-1.

CAUTION

Power to the MRF89XAMxA PICtail/PICtail Plus Daughter Board should be in the range of 2.1–3.6V. Ensure that the development/demonstration board that the daughter board is plugged into meets this voltage requirement; otherwise, damage to the MRF89XA might occur.

MRF89XAMxA PICtail™/PICtail Plus Daughter Board User's Guide

FIGURE 1-1: MRF89XAMxA PICtail™/PICtail PLUS DAUGHTER BOARD

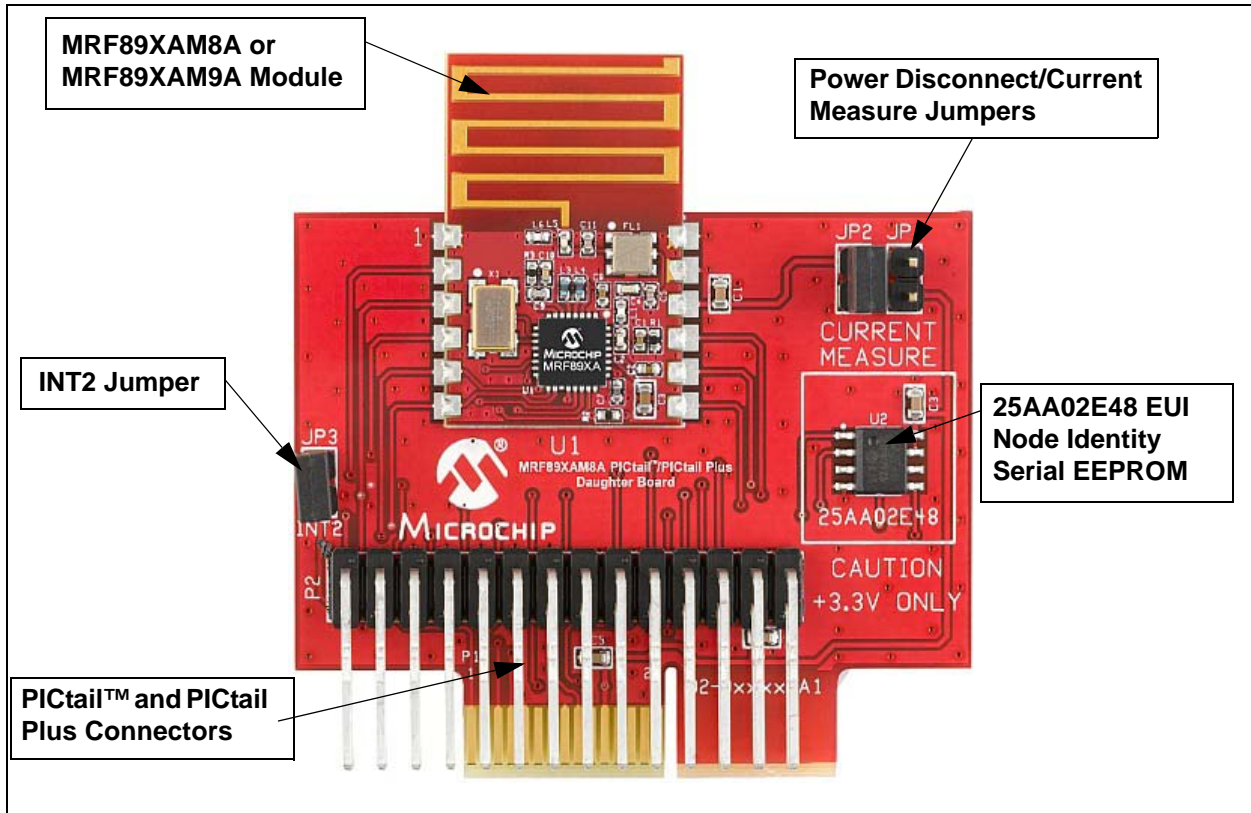

PICtail Plus Connector (P1) – 30-pin card edge connector for connecting to the 16-bit and 32-bit development boards' PICtail Plus connector.

PICtail Connector (P2) – 28-pin right angle connector to connect to the 8-bit development boards' PICtail connector.

MRF89XAM8A (U1) – Ultra Low-Power Sub-GHz transceiver module – 868 MHz.

MRF89XAM9A (U1) – Ultra Low-Power Sub-GHz transceiver module – 915 MHz.

Power Disconnect/Current Measure Jumpers (JP1/JP2) – Two 2-pin headers are connected in parallel. A shunt on one of the two headers connects power to the MRF89XAMxA module. A current meter can be placed on the open header and when the shunt is removed from the opposite header, current consumption can be measured without interrupting power. A useful cable that can be connected to the 2-pin header and current meter, using banana plugs, is the XLP Current Measurement Cable (AC002023).

INT2 Jumper (JP3) – Jumpering JP3 with a shunt allows you to connect RA5 to RB2/INT2, this enables push button switch S2 to trigger an interrupt. For more information, see **Section 2.2.1 "Configuring Push Button Switch S2 to RB2/INT2"**.

EUI Node Identity Serial EEPROM (U3) – Contains a unique IEEE EUI address. For more information, refer to the *"2K SPI Bus Serial EEPROM with EUI-48™ Node Identity Data Sheet"* (DS22123).



MRF89XAMxA PICtail™/PICtail PLUS DAUGHTER BOARD USER'S GUIDE

Chapter 2. Getting Started

2.1 INTRODUCTION

The MRF89XAMxA PICtail/PICtail Plus Daughter Board can be plugged into multiple Microchip Technology demonstration and development boards. This allows the developer to choose the microcontroller that best suits the customer's development environment.

The PICtail connector right-angle header, P2, can be plugged into the PIC18 Explorer Development Board (DM183032). The PICtail Plus card-edge connector, P1, can be plugged into Explorer 16 Development Board (DM240001).

This chapter describes how the daughter board is plugged into the PIC18 Explorer and Explorer 16 Development Boards.

2.2 PLUGGING INTO THE PIC18 EXPLORER BOARD

The MRF89XAMxA PICtail/PICtail Plus Daughter Board can be plugged into the PIC18 Explorer Board PICtail connector, J3, as shown in Figure 2-1. Make sure to align pin 1 to RE2 as shown.

CAUTION

Ensure that the PIC18F87J11 PIM is plugged into the PIC18 Explorer Board. This sets the system VDD voltage to 3.3 volts, which is required by the MRF89XAMxA PICtail/PICtail Plus Daughter Board.

2.2.1 Configuring Push Button Switch S2 to RB2/INT2

On the PIC18 Explorer Board, push button switch S2 is normally connected to I/O port pin RA5. RA5 is not an interrupt-on-change or external interrupt capable I/O pin. Jumpering JP3 with a shunt allows the connection of RA5 to RB2/INT2 to allow push button switch S2 to trigger an interrupt. Remember that RB2 also connects to pin 10 (input) of U6 (RS232 level shifter), which is a Clear-to-Send (CTS) signal on P2 pin 8 (DE9 receptacle).

FIGURE 2-1: MRF89XAMxA PICtail™/PICtail PLUS DAUGHTER BOARD PLUGGED INTO PIC18 EXPLORER BOARD

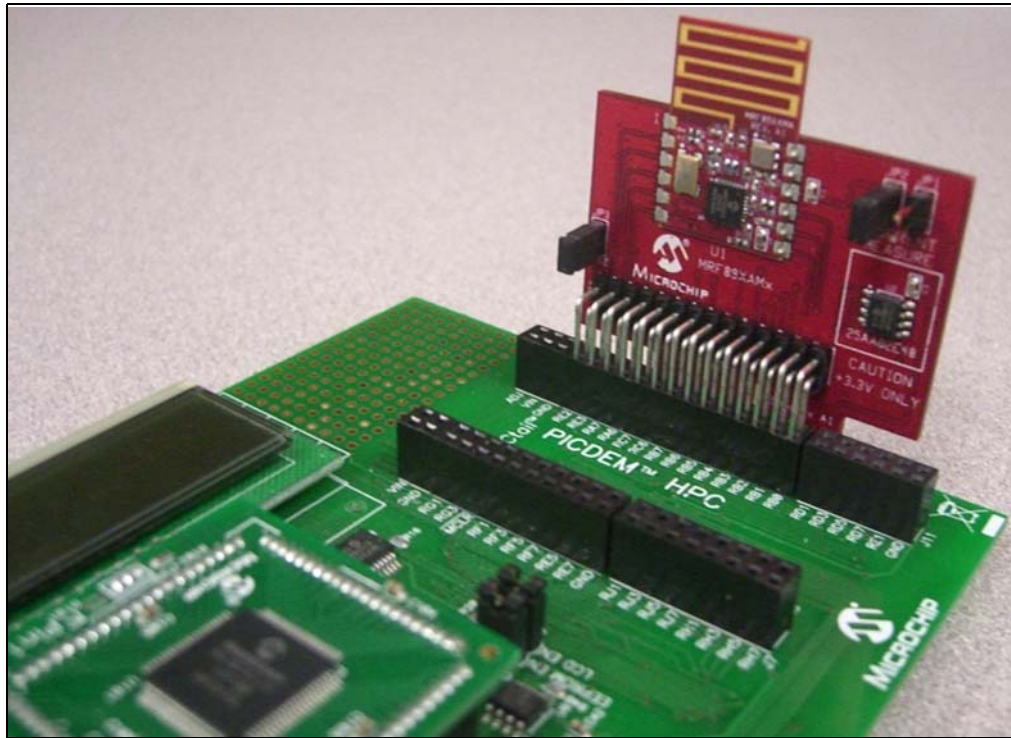

2.3 PLUGGING INTO THE EXPLORER 16 DEVELOPMENT BOARD

The MRF89XAMxA PICtail/PICtail Plus Daughter Board can be plugged into the Explorer 16 Development Board as shown in Figure 2-2.

The MRF89XAMxA PICtail/PICtail Plus Daughter Board's 30-pin card edge connector is plugged into the top section of the PICtail Plus connector. This will connect to the SPI Port 1 on the PIC® microcontroller that is plugged into the Plug In Module (PIM) socket.

The MRF89XAMxA PICtail/PICtail Plus Daughter Board's 30-pin card edge connector is plugged into the mid-section of the PICtail Plus connector. This will connect to the SPI Port 2 on the PIC microcontroller that is plugged into the PIM socket.

FIGURE 2-2: MRF89XAMxA PICtail™/PICtail PLUS DAUGHTER BOARD PLUGGED INTO EXPLORER 16 DEVELOPMENT BOARD

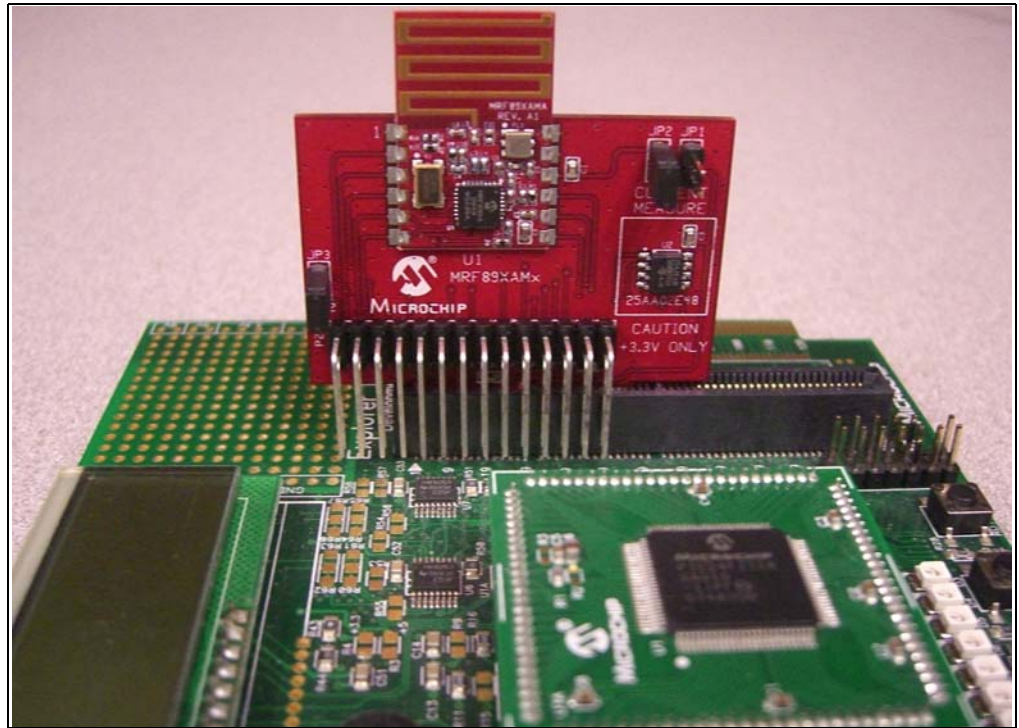

2.4 DOWNLOADING AND RUNNING THE DEMO PROGRAM

A Quick Start Guide is included in the software installation package that explains the installation and operation of the demonstration program. It may be downloaded from the Microchip website <http://www.microchip.com/miwi>.

MRF89XAMxA PICtail™/PICtail Plus Daughter Board User's Guide

NOTES:



MRF89XAMxA PICtail™/PICtail PLUS DAUGHTER BOARD USER'S GUIDE

Appendix A. MRF89XAMxA PICtail/PICtail Plus Daughter Board Schematic

A.1 INTRODUCTION

This appendix provides the MRF89XAMxA PICtail/PICtail Plus Daughter Board schematics, PCB layout and Bill of Materials (BOM).

- MRF89XAMxA PICtail/PICtail Plus Daughter Board Schematic
- MRF89XAMxA PICtail/PICtail Plus Daughter Board PCB Layout
- MRF89XAMxA PICtail/PICtail Plus Daughter Board Bill of Materials

A.2 MRF89XAMxA PICtail/PICtail PLUS DAUGHTER BOARD SCHEMATIC

FIGURE A-1: MRF89XAMxA PICtail™/PICtail PLUS DAUGHTER BOARD SCHEMATIC

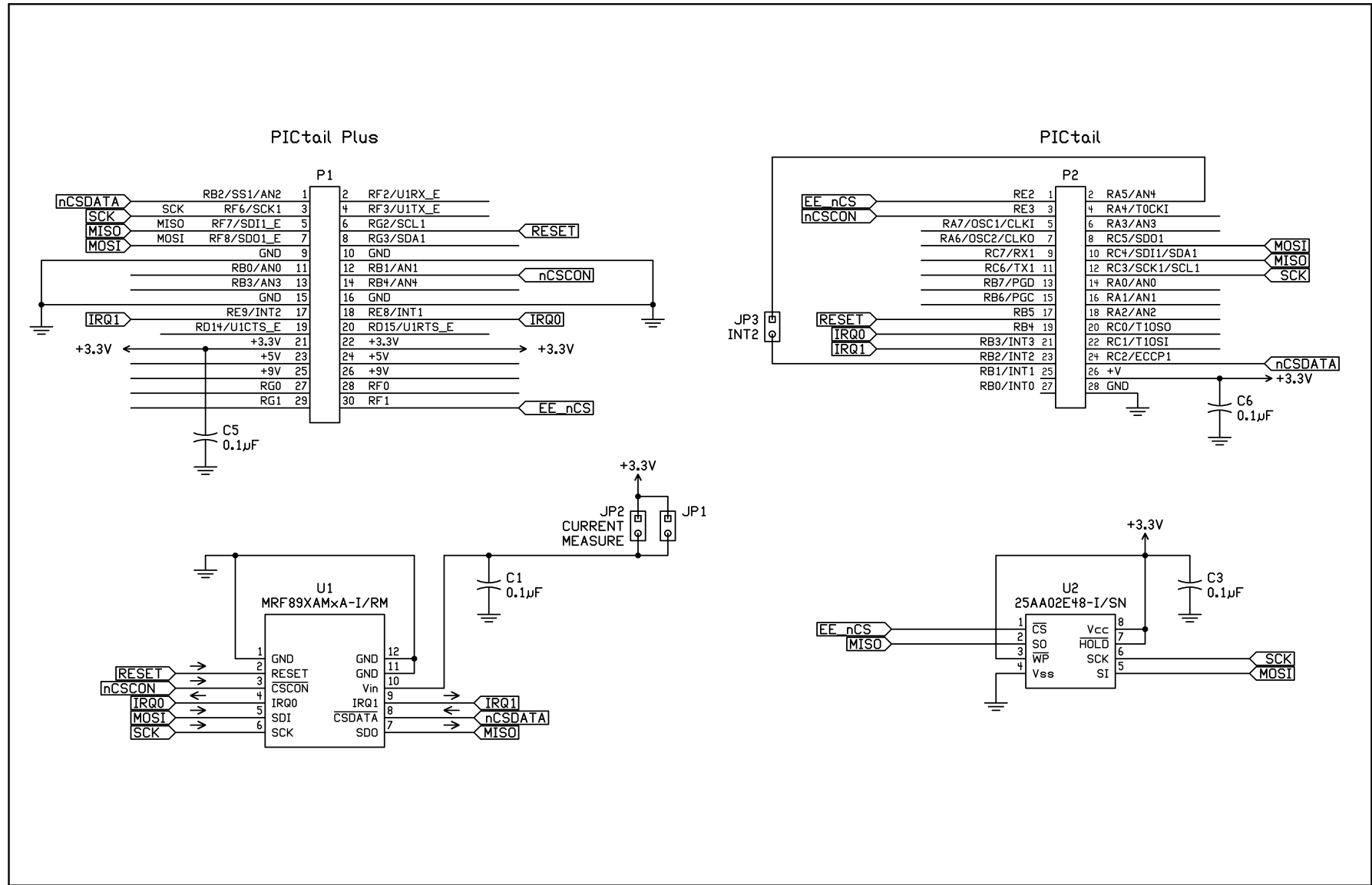

MRF89XAMxA PICtail/PICtail Plus Daughter Board Schematic

A.3 MRF89XAMxA PICtail/PICtail PLUS DAUGHTER BOARD PCB LAYOUT

The MRF89XAMxA PICtail/PICtail Plus Daughter Board is a 2-layer, FR4, 0.062 inch, plated through hole PCB construction.

FIGURE A-2: MRF89XAMxA PICtail™/PICtail PLUS DAUGHTER BOARD TOP SILKSCREEN

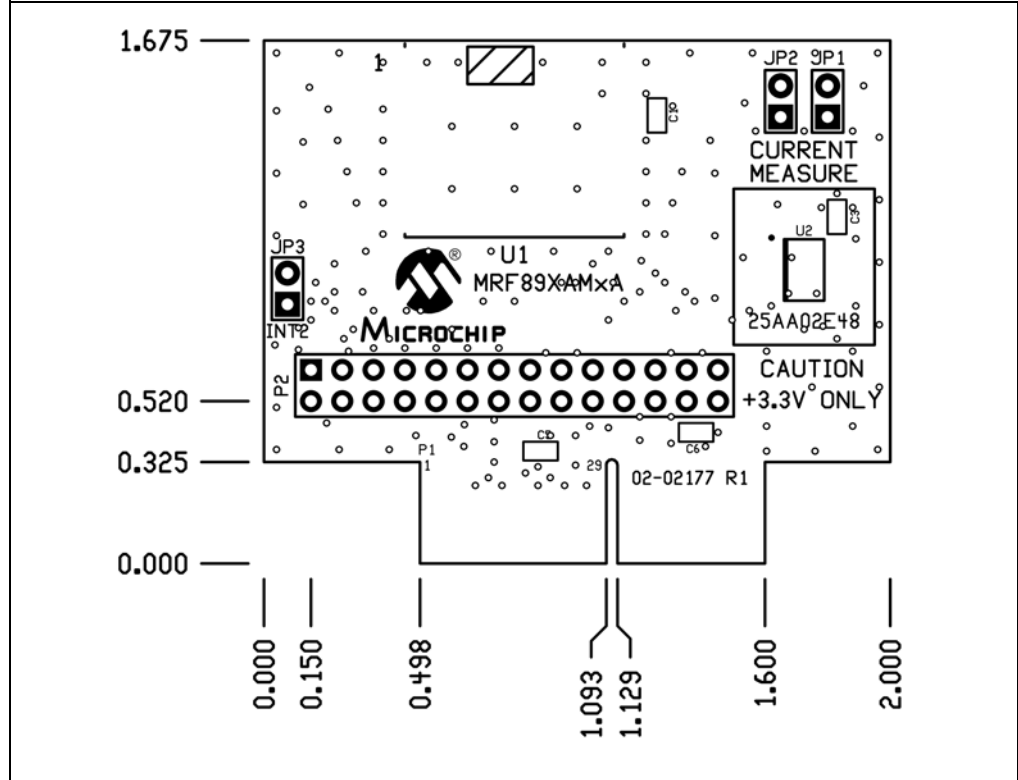

FIGURE A-3: MRF89XAMxA PICtail™/PICtail PLUS DAUGHTER BOARD TOP COPPER

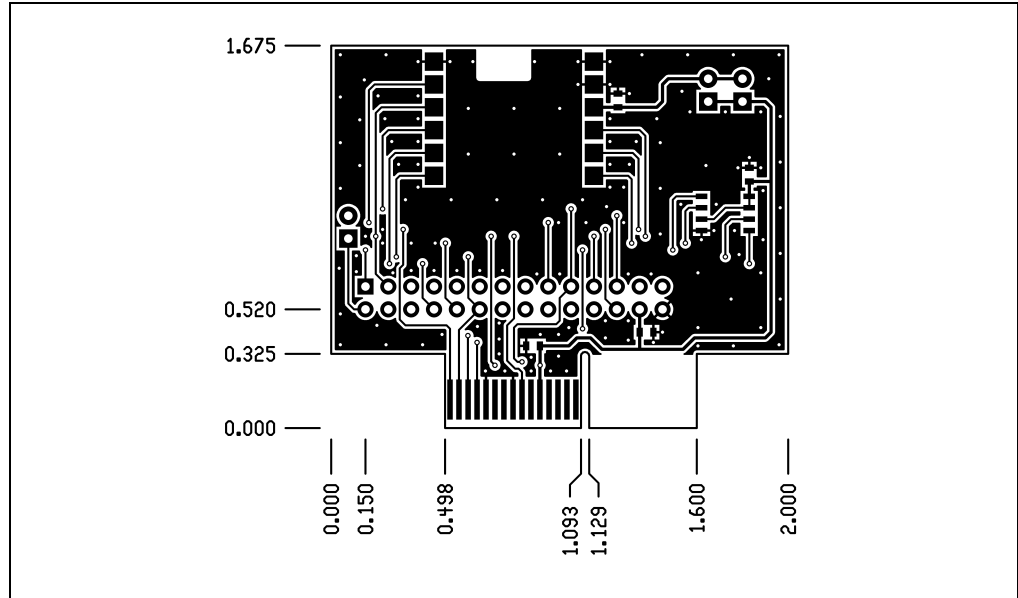

FIGURE A-4: MRF89XAMxA PICtail™/PICtail PLUS DAUGHTER BOARD BOTTOM COPPER

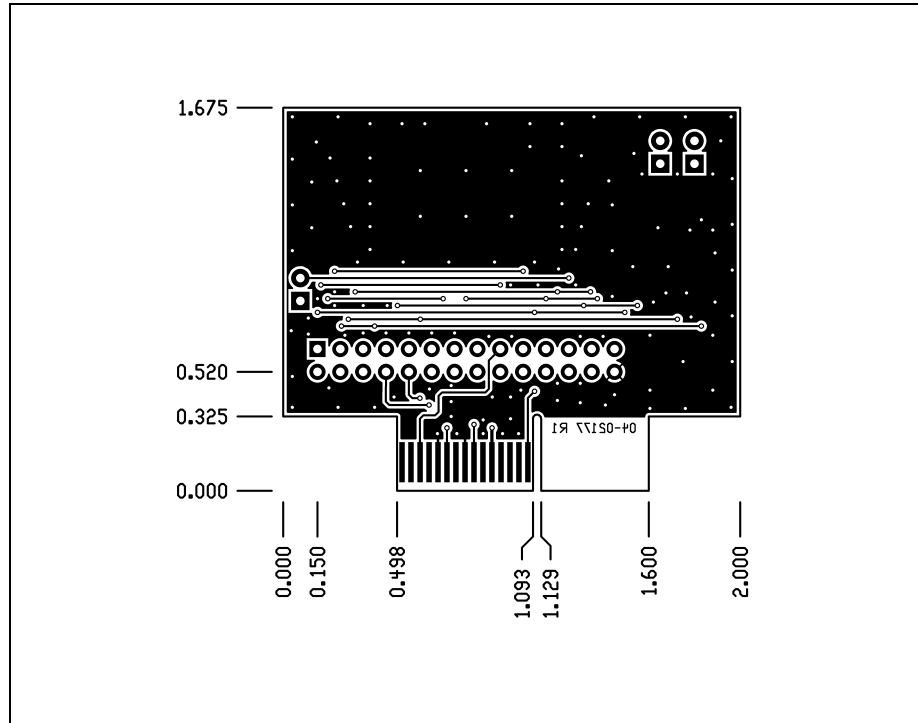
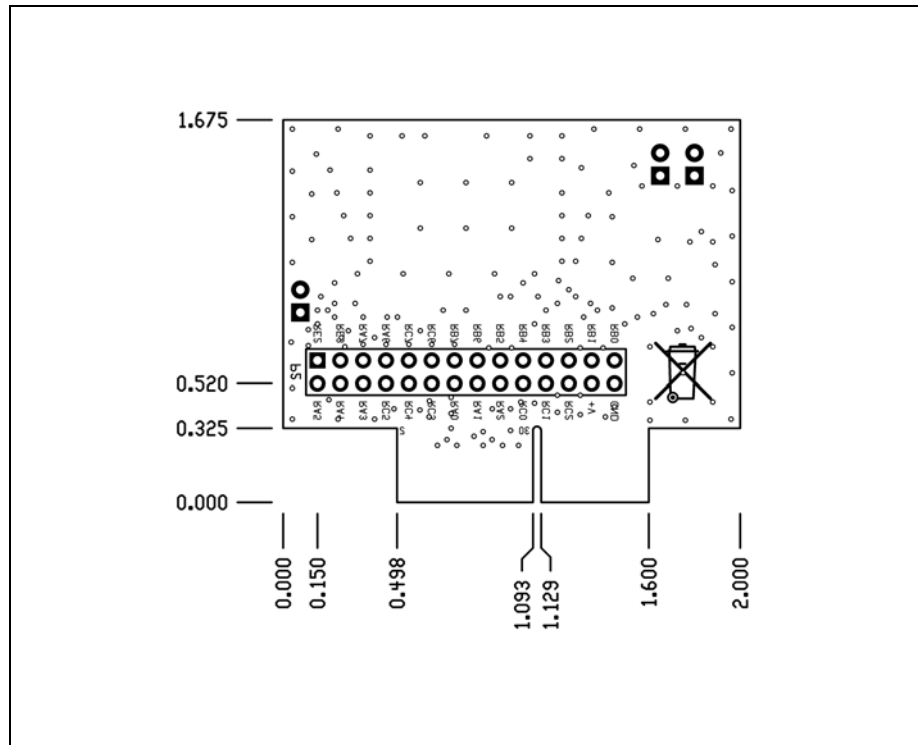

FIGURE A-5: MRF89XAMxA PICtail™/PICtail PLUS DAUGHTER BOARD BOTTOM SILKSCREEN



MRF89XAMxA PICtail/PICtail Plus Daughter Board Schematic

A.4 MRF89XAMxA PICtail/PICtail PLUS DAUGHTER BOARD BILL OF MATERIALS

TABLE A-1: MRF89XAMxA PICtail™/PICtail PLUS DAUGHTER BOARD BILL OF MATERIALS

Reference	Value	Description	Vendor	Vendor P/N	Comments
C1, C2, C3, C5, C6	0.1 μ F	Capacitor, Ceramic, 50V, C0G, SMT 0603	Panasonic	ECJ-1VB1C104K	Bypass capacitor
JP1, JP2, JP3	—	Connector, Header, 1x2, 0.100" pitch, 0.025" sq post	SPC Technology	SPC20481	—
Shunt	—	Connector, Shunt, 0.100" pitch	Sullins Connector Solutions	STC02SYAN	Shunts for JP1 and JP3
P2	—	Connector, Header, 2x14, 0.100" pitch, right angle 0.390/0.230	Sullins Connector Solutions	GBC14DBDN	—
U1	MRF89XAM8A	MRF89XAM8A RF Transceiver Module	Microchip Technology	MRF89XAM8A-I/RM	Populated only on 868 MHz Daughter Board
U1	MRF89XAM9A	MRF89XAM9A RF Transceiver Module	Microchip Technology	MRF89XAM9A-I/RM	Populated only on 915 MHz Daughter Board
U3	25AA02E48	EUI-48 Node Identity Serial EEPROM	Microchip Technology	25AA02E48-I/SN	—

NOTES:



MICROCHIP

Worldwide Sales and Service

AMERICAS

Corporate Office
2355 West Chandler Blvd.
Chandler, AZ 85224-6199
Tel: 480-792-7200
Fax: 480-792-7277
Technical Support:
<http://support.microchip.com>
Web Address:
www.microchip.com

Atlanta
Duluth, GA
Tel: 678-957-9614
Fax: 678-957-1455

Boston
Westborough, MA
Tel: 774-760-0087
Fax: 774-760-0088

Chicago
Itasca, IL
Tel: 630-285-0071
Fax: 630-285-0075

Cleveland
Independence, OH
Tel: 216-447-0464
Fax: 216-447-0643

Dallas
Addison, TX
Tel: 972-818-7423
Fax: 972-818-2924

Detroit
Farmington Hills, MI
Tel: 248-538-2250
Fax: 248-538-2260

Kokomo
Kokomo, IN
Tel: 765-864-8360
Fax: 765-864-8387

Los Angeles
Mission Viejo, CA
Tel: 949-462-9523
Fax: 949-462-9608

Santa Clara
Santa Clara, CA
Tel: 408-961-6444
Fax: 408-961-6445

Toronto
Mississauga, Ontario,
Canada
Tel: 905-673-0699
Fax: 905-673-6509

ASIA/PACIFIC

Asia Pacific Office
Suites 3707-14, 37th Floor
Tower 6, The Gateway
Harbour City, Kowloon
Hong Kong
Tel: 852-2401-1200
Fax: 852-2401-3431

Australia - Sydney
Tel: 61-2-9868-6733
Fax: 61-2-9868-6755

China - Beijing
Tel: 86-10-8528-2100
Fax: 86-10-8528-2104

China - Chengdu
Tel: 86-28-8665-5511
Fax: 86-28-8665-7889

China - Chongqing
Tel: 86-23-8980-9588
Fax: 86-23-8980-9500

China - Hong Kong SAR
Tel: 852-2401-1200
Fax: 852-2401-3431

China - Nanjing
Tel: 86-25-8473-2460
Fax: 86-25-8473-2470

China - Qingdao
Tel: 86-532-8502-7355
Fax: 86-532-8502-7205

China - Shanghai
Tel: 86-21-5407-5533
Fax: 86-21-5407-5066

China - Shenyang
Tel: 86-24-2334-2829
Fax: 86-24-2334-2393

China - Shenzhen
Tel: 86-755-8203-2660
Fax: 86-755-8203-1760

China - Wuhan
Tel: 86-27-5980-5300
Fax: 86-27-5980-5118

China - Xian
Tel: 86-29-8833-7252
Fax: 86-29-8833-7256

China - Xiamen
Tel: 86-592-2388138
Fax: 86-592-2388130

China - Zhuhai
Tel: 86-756-3210040
Fax: 86-756-3210049

ASIA/PACIFIC

India - Bangalore
Tel: 91-80-3090-4444
Fax: 91-80-3090-4123

India - New Delhi
Tel: 91-11-4160-8631
Fax: 91-11-4160-8632

India - Pune
Tel: 91-20-2566-1512
Fax: 91-20-2566-1513

Japan - Yokohama
Tel: 81-45-471- 6166
Fax: 81-45-471-6122

Korea - Daegu
Tel: 82-53-744-4301
Fax: 82-53-744-4302

Korea - Seoul
Tel: 82-2-554-7200
Fax: 82-2-558-5932 or
82-2-558-5934

Malaysia - Kuala Lumpur
Tel: 60-3-6201-9857
Fax: 60-3-6201-9859

Malaysia - Penang
Tel: 60-4-227-8870
Fax: 60-4-227-4068

Philippines - Manila
Tel: 63-2-634-9065
Fax: 63-2-634-9069

Singapore
Tel: 65-6334-8870
Fax: 65-6334-8850

Taiwan - Hsin Chu
Tel: 886-3-6578-300
Fax: 886-3-6578-370

Taiwan - Kaohsiung
Tel: 886-7-213-7830
Fax: 886-7-330-9305

Taiwan - Taipei
Tel: 886-2-2500-6610
Fax: 886-2-2508-0102

Thailand - Bangkok
Tel: 66-2-694-1351
Fax: 66-2-694-1350

EUROPE

Austria - Wels
Tel: 43-7242-2244-39
Fax: 43-7242-2244-393

Denmark - Copenhagen
Tel: 45-4450-2828
Fax: 45-4485-2829

France - Paris
Tel: 33-1-69-53-63-20
Fax: 33-1-69-30-90-79

Germany - Munich
Tel: 49-89-627-144-0
Fax: 49-89-627-144-44

Italy - Milan
Tel: 39-0331-742611
Fax: 39-0331-466781

Netherlands - Druenen
Tel: 31-416-690399
Fax: 31-416-690340

Spain - Madrid
Tel: 34-91-708-08-90
Fax: 34-91-708-08-91

UK - Wokingham
Tel: 44-118-921-5869
Fax: 44-118-921-5820

08/04/10