

Tous droits strictement réservés. Reproduction ou communication a des tiers interdite sous quelque forme que ce soit sans autorisation écrite du propriétaire. Propriété de c FCI. Droits de reproduction FCI.

All rights strictly reserved. Reproduction or issue to third parties in any form whatever is not permitted without written authority from the proprietor. Property of FCI. Copyright FCI.

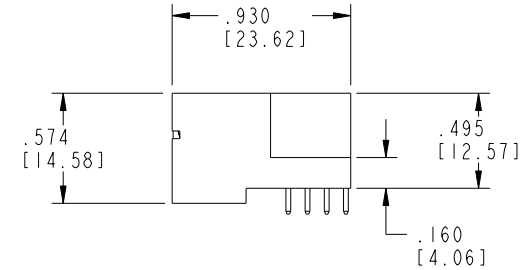
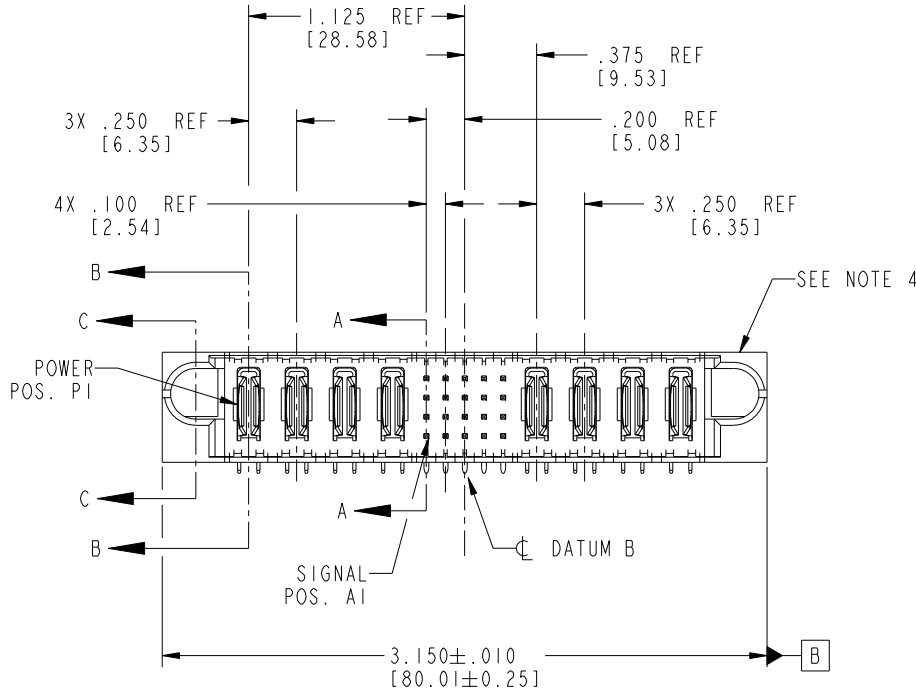
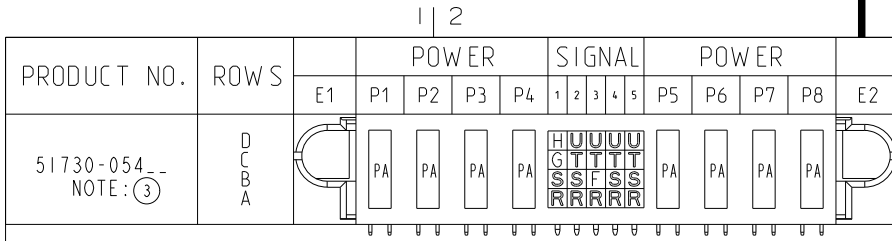

CODE	DIM "M" MATING LENGTH	CONTACT TYPE
F	.220 [5.59]	SIGNAL
G	.220 [5.59]	SIGNAL
H	.220 [5.59]	SIGNAL
R	.270 [6.86]	SIGNAL
S	.270 [6.86]	SIGNAL
T	.270 [6.86]	SIGNAL
U	.270 [6.86]	SIGNAL
PA	N/A [N/A]	POWER

mat'l code				SEE NOTE 2		tolerances unless otherwise specified		CUSTOMER		 www.fciconnect.com	
ltr	ecn no.	dr	date	linear	.XX±.01/0.XX±0.3		COPY		title		
A	V21165	TAB	07/16/02		.XXX±.005/0.XX±0.13		projection		4P + 20S + 4P		
B	DG05-0243	SJ	07/26/05	angles	.XXX±.0020/0.XXX±0.051				R/A SOLDER HEADER		
C	DG05-0560	CS	12/26/05		0° ± 2°		INCH/MM		product family		code
D	DG08-0272	WD	09/27/08	dr	T.BRUNGARD	07/16/02	scale		PwrBlade		213
				engr	M.MOSTOLLER	07/16/02	1:1		size		sheet
				chr	M.MOSTOLLER	07/16/02			dwg no		1 of 4
				appd	M.MOSTOLLER	07/16/02			A 51730-054		
sheet index	revision sheet	D	D	D	D	D			cage code		4
		1	2	3	4				22536		

Pro/E

PDM: Rev: D

STATUS: Released

Printed: Dec 20, 2010

Tous droits strictement réservés. Reproduction ou communication a des tiers interdite sous quelque forme que ce soit sans autorisation écrite du propriétaire. Propriété de c FCI. Droits de reproduction FCI.

All rights strictly reserved. Reproduction or issue to third parties in any form whatever is not permitted without written authority from the proprietor. Property of FCI. Copyright FCI.



PRODUCT NUMBER

51730-054--

NOTE: ③

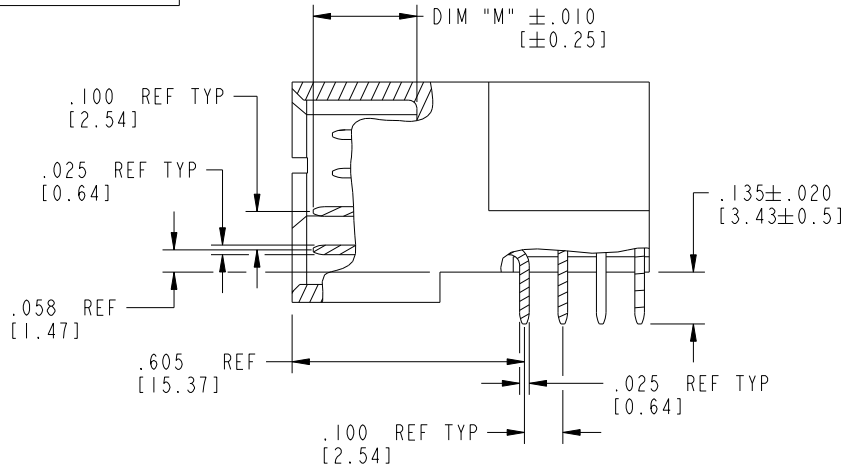

BROKEN-OUT SECTION A-A  
SCALE 2:1

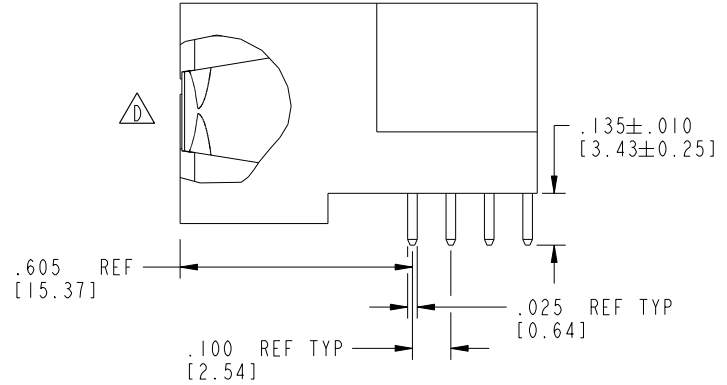

BROKEN-OUT SECTION B-B  
SCALE 2:1

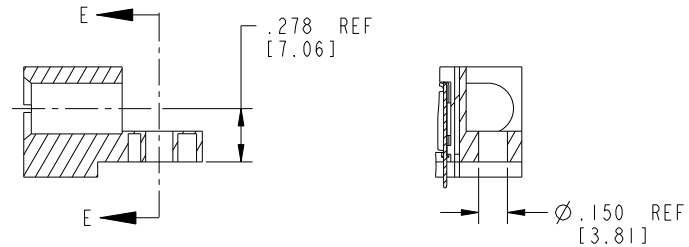

PARTIAL SECTION E-E

SECTION C-C

mat'l code		SEE NOTE 2		tolerances unless otherwise specified		CUSTOMER		 www.fciconnect.com	
lir	ecn no.	dr	date	linear	.XX±.01/0.X±0.3	COPY		title	
D					.XX±.005/0.XX±0.13	projection		4P + 20S + 4P	
				angles	.XXX±.0020/0.XXX±0.051			R/A SOLDER HEADER	
				dr	T. BRUNGARD 07/16/02	INCH/MM		product family	
				engr	M. MOSTOLLER 07/16/02	scale		PwrBlade	
				chr	M. MOSTOLLER 07/16/02	1:1		size	
				appd	M. MOSTOLLER 07/16/02			dwg no	
sheet index		revision sheet						A 51730-054	
								code	
								213	
								sheet	
								2 of 4	

Pro/E

PDM: Rev:D

STAT: Released

Printed: Dec 20, 2010

cage code 22516

Tous droits strictement réservés. Reproduction ou communication a des tiers interdite sous quelque forme que ce soit sans autorisation écrite du propriétaire. Propriété de c FCI. Droits de reproduction FCI.



All rights strictly reserved. Reproduction or issue to third parties in any form whatever is not permitted without written authority from the proprietor. Property of FCI. Copyright FCI.

PRODUCT NUMBER  
51730-054--  
NOTE: ③

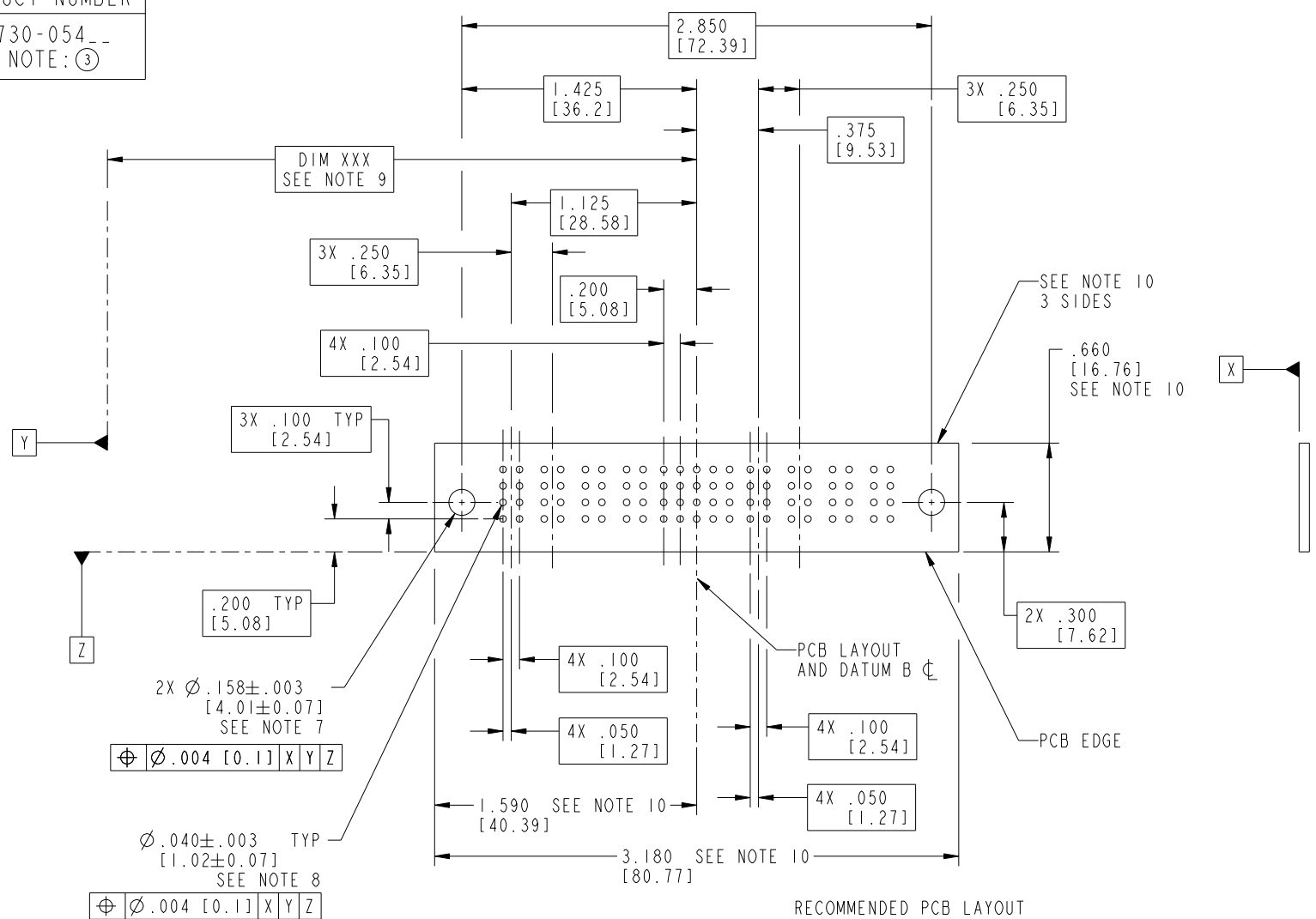

RECOMMENDED PCB LAYOUT

mat'l code		SEE NOTE 2		tolerances unless otherwise specified		CUSTOMER		 www.fciconnect.com	
ltr	ecn no.	dr	date	linear	.XX±.01/0.X±0.3	projection	title		
C				angles	.XXX±.005/0.XX±0.13		4P + 20S + 4P		
				dr	.XXX±.0020/0.XXX±0.051	INCH/MM	R/A SOLDER HEADER		
				enr	0°±2°	scale	product family		code
				chr	T.BRUNGARD 07/16/02	1:1	PwrBlade		213
				appd	M.MOSTOLLER 07/16/02		size	dwg no	sheet
					M.MOSTOLLER 07/16/02		A	51730-054	3 of 4
sheet index	revision sheet								

cage code 28516

Pro/E

PDM: Rev: D

STATUS: Released

Printed: Dec 20, 2010

PRODUCT NUMBER  
51730-054--  
NOTE: ③

NOTES:

1. DIMENSIONS AND TOLERANCES ARE IN ACCORDANCE WITH ASME Y14.5M, 1994 UNLESS OTHERWISE SPECIFIED.

CONNECTOR NOTES:

- ② HOUSING MATERIAL: UL 94 V-0 GLASS FILLED HIGH-TEMP THERMOPLASTIC  
POWER CONTACT MATERIAL: COPPER ALLOY  
SIGNAL PIN MATERIAL: COPPER ALLOY
  - △ 3. SEE ITEM 1 & 2 IN PRINT 10064183 FOR PLATING SPEC OF 51730-054 AND 51730-054LF RESPECTIVELY.
  - ④ MANUFACTURER'S NAME, P/N, AND DATE CODE TO APPEAR ON THIS SURFACE.
  - 5. PRODUCT SPECIFICATION GS-12-149.  
APPLICATION SPECIFICATION BUS-20-067.
- PCB NOTES:
- 6. ALL HOLE DIAMETERS ARE FINISHED HOLE SIZE.
  - 7. MOUNTING HOLES, WHERE APPLICABLE, ARE UNPLATED.
  - ⑧  $\varnothing .0453 \pm .0010$  [1.151  $\pm$  0.025] DRILLED HOLES PLATED WITH  
.0003 [0.008] MIN SnPb OVER .001 [0.03]  
TO .003 [0.08] Cu PLATING TO ACHIEVE  
 $\varnothing .040 \pm .003$  [1.02  $\pm$  .07] HOLE.
  - ⑨ "DIM XXX" TO BE DETERMINED BY THE CUSTOMER.
  - ⑩ CONNECTOR KEEP-OUT ZONE.
  - 11. A/△ SYMBOL WILL BE NEXT TO ANY DIMENSION, VIEW, OR NOTE WHICH HAS BEEN MODIFIED WITH THE CURRENT DRAWING REVISION.

mat'l code		SEE NOTE 2		tolerances unless otherwise specified		CUSTOMER		FCJ		www.fciconnect.com	
ltr	ecn no.	dr	date	linear	.XX±.01/0.X±0.3	COPY		projection		title	
D					.XXY±.005/0.XX±0.13	INCH/MM				4P + 20S + 4P R/A SOLDER HEADER	
				angles	.XXX±.0020/0.XXX±0.051 0° ± 2°	scale		product family		code	
				dr	T.BRUNGARD 07/16/02	1:1		PwrBlade		213	
				engr	M.MOSTOLLER 07/16/02			size		sheet	
				chr	M.MOSTOLLER 07/16/02			A		4 of 4	
				appd	M.MOSTOLLER 07/16/02			51730-054			
sheet index	revision sheet										

Tous droits strictement réservés. Reproduction ou communication a des tiers interdite sous quelque forme que ce soit sans autorisation écrite du propriétaire. Propriété de c FCI. Droits de reproduction FCI.



All rights strictly reserved. Reproduction or issue to third parties in any form whatever is not permitted without written authority from the proprietor. Property of FCI. Copyright FCI.