

LA-300 SERIES

Related Information

- General terms and conditions..... P.1
- Sensor selection guideP.11~ / P.833~
- CA2.....P.793~
- General precautions..... P.1027

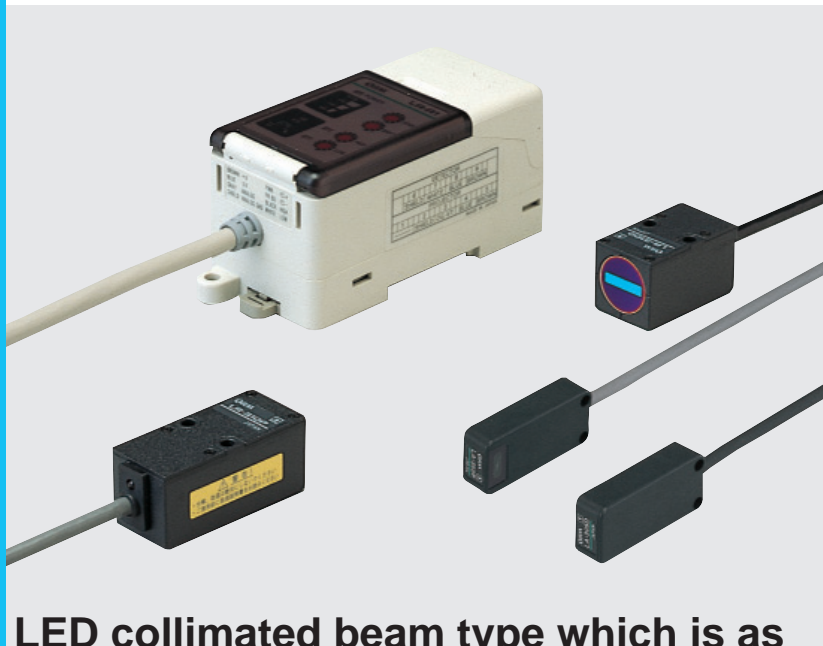

LED collimated beam type which is as accurate as a laser sensor, but much safer

Safe red LED beam

Since a red LED, harmless to your eyes, has been incorporated as the beam source, you are free from strict laser safety regulations. Moreover, due to the red LED beam source, the measuring spot is visible, which makes positioning of the object simple.

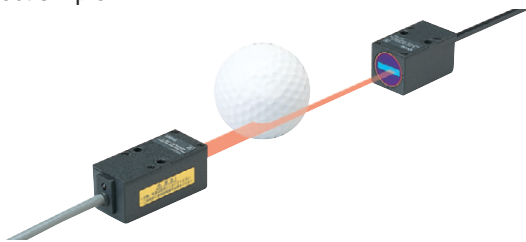

Compact size

Its emitter and receiver are much smaller compared to those of the amplifier built-in type (LA-510). Hence, they can be installed even in a narrow space inside an automatic assembly machine, etc.

Long sensing range type / LA-310



- Emitter: W20 × H20 × D45 mm
W0.787 × H0.787 × D1.772 in
- Receiver: W20 × H20 × D35 mm
W0.787 × H0.787 × D1.378 in

Slim type / LA-305



- Emitter: W18 × H40 × D10 mm
W0.709 × H1.575 × D0.394 in
- Receiver: W18 × H40 × D10 mm
W0.709 × H1.575 × D0.394 in

FUNCTIONS

Span & shift adjustment

For the analog output, in addition to the span adjustment function, a convenient shift function which enables the analog voltage to be shifted by ±0.5 V has been incorporated.

Example: To shift the analog voltage from 2.51 V to 3.00 V with a certain amount of beam interruption

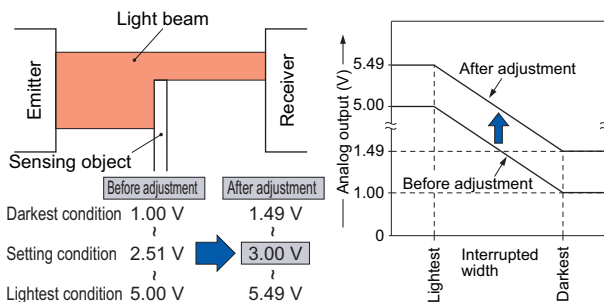

MOUNTING

Simple beam alignment

Beam alignment is easy by using the target label (accessory). Further, the 3-stage stability indicators on the amplifier indicate the incident beam level at a glance.

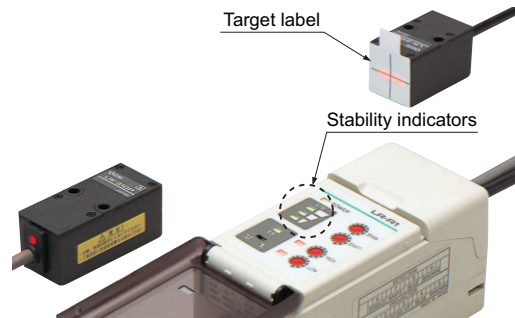

Selection Guide
Laser Displacement
HL-C2
HL-C1
LM10
Magnetic Displacement
GP-X
GP-A
Collimated Beam Sensors
HL-T1
LA-300
LA
Other Products

APPLICATIONS

Detecting unseated wafers

Two sensors inspect vertical and lateral displacement of wafers.

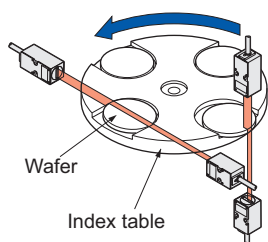

Inspecting burrs on workpieces

If burrs are present, they increase the width of beam interruption.

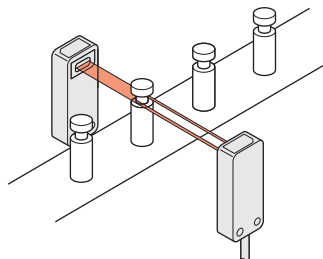

Detecting glass bottles

Even clear glass bottles are reliably detected.

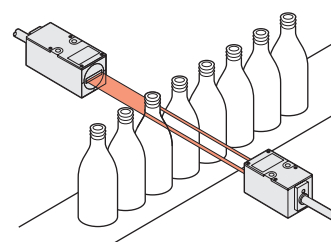

ORDER GUIDE

Sensor heads

Type	Appearance	Sensing range	Sensing width	Minimum sensing object	Model No. (Note)
Long sensing range		500 mm 19.685 in	10 mm 0.394 in	ø0.1 mm ø0.004 in opaque object	LA-310
Slim		300 mm 11.811 in	5 mm 0.197 in	ø0.05 mm ø0.002 in opaque object	LA-305

Order for the long sensing range type **LA-310** will be stopped by December, 2007.

Note: The model No. with suffix "P" shown on the label affixed to the product is the emitter, "D" shown on the label is the receiver.
(e.g.) Emitter of **LA-305**: **LA-305P**, Receiver of **LA-305**: **LA-305D**

Amplifiers

Type	Appearance	Model No.	Output
NPN output		LA-A1	NPN open-collector transistor (Comparative outputs) Analog voltage • Output voltage: 1 to 5 V
PNP output		LA-A1P	PNP open-collector transistor (Comparative outputs) Analog voltage • Output voltage: 1 to 5 V

Always use the sensor head and the amplifier together as a set.

Accessories

- **MS-LA3-1**
(Sensor head mounting bracket for **LA-310**)
(Note)

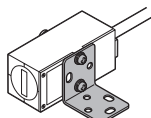

Two M3 (length 25 mm 0.984 in) screws with washers are attached.

- **MS-LA3-2**
(Sensor head mounting bracket for **LA-305**)
(Note)



Two M3 (length 15 mm 0.591 in) screws with washers are attached.

Note: 2 sets are required to mount the emitter / receiver.

- FIBER SENSORS
- LASER SENSORS
- PHOTO-ELECTRIC SENSORS
- MICRO PHOTO-ELECTRIC SENSORS
- AREA SENSORS
- SAFETY COMPONENTS
- PRESSURE SENSORS
- INDUCTIVE PROXIMITY SENSORS
- PARTICULAR USE SENSORS
- SENSOR OPTIONS
- WIRE-SAVING SYSTEMS
- MEASUREMENT SENSORS
- STATIC CONTROL DEVICES
- LASER MARKERS
- Selection Guide
- Laser Displacement
- HL-C2**
- HL-C1**
- LM10**
- Magnetic Displacement
- GP-X**
- GP-A**
- Collimated Beam Sensors
- HL-T1**
- LA-300**
- LA**
- Other Products

OPTIONS**Digital panel controller**• **CA2-T2**

Designation	Model No.	Description
Digital panel controller (Note)	CA2-T2	This is a very small controller which allows two independent threshold level settings. <ul style="list-style-type: none"> • Supply voltage: 24 V DC \pm 10 % • Output: NPN open-collector transistor • No. of inputs: 1 No. (sensor input) • Input range: 1 to 5 V DC • Main functions: Threshold value setting function, zero-adjust function, scale setting function, hysteresis setting function, start / hold function, auto-reference function, power supply ON-delay function, etc.

Note: If analog voltage output of **LA-A1** or **LA-A1P** is shifted, the input range may be exceeded. In that case, use **CA2-T5** (input range -10 to +10 V). For further details, refer to p.793- for the ultra-compact digital panel controller **CA2** series.

SPECIFICATIONS**Sensor heads**

Item	Type	Long sensing range	Slim
	Model No.	LA-310	LA-305
Applicable amplifiers		LA-A1, LA-A1P	
Beam width		10 mm 0.394 in	5 mm 0.197 in
Sensing range		500 mm 19.685 in	300 mm 11.811 in
Min. sensing object		\varnothing 0.1 mm \varnothing0.004 in opaque object	\varnothing 0.05 mm \varnothing0.002 in opaque object
Repeatability		Perpendicular to sensing axis: 0.01 mm 0.0004 in or less	
Temperature characteristics		0.1 % F.S./ $^{\circ}$ C or less	0.2 % F.S./ $^{\circ}$ C or less
Emission indicator		Red LED (lights up when emitting)	—
Environmental resistance	Pollution degree	3 (Industrial environment)	
	Ambient temperature	0 to +40 $^{\circ}$ C +32 to +104 $^{\circ}$F (No dew condensation), Storage: -20 to +70 $^{\circ}$ C -4 to +158 $^{\circ}$F	
	Ambient humidity	35 to 85 % RH, Storage: 35 to 85 % RH	
	Ambient illuminance	Incandescent light: 10,000 lx at the light-receiving face	
	EMC	EN 61000-6-2, EN 61000-6-4	
	Voltage withstandability	1,000 V AC for one min. between all supply terminals connected together and enclosure	
	Insulation resistance	20 M Ω , or more, with 250 V DC megger between all supply terminals connected together and enclosure	
	Vibration resistance	10 to 150 Hz frequency, 0.75 mm 0.030 in amplitude in X, Y and Z directions for two hours each	
Shock resistance	500 m/s ² acceleration (50 G approx.) in X, Y and Z directions for three times each		
Emitting element	Red LED (Peak emission wavelength 670 nm 0.026 mil , modulated)	Red LED (Peak emission wavelength 650 nm 0.026 mil , modulated)	
Material	Enclosure: Die-cast zinc alloy Top face: Aluminum	Enclosure: Heat-resistant ABS Cover: Heat-resistant ABS, Front cover: Glass	
Cable	0.22 mm ² 3-core composite cable, 2 m 6.562 ft long	0.18 mm ² 3-core composite cable, 2 m 6.562 ft long	
Cable extension	Extension up to total 10 m 32.808 ft is possible, for both emitter and receiver, with 0.22 mm ² , or more, cable. (Shield wire must be extended with shield wire.)	Extension up to total 10 m 32.808 ft is possible, for both emitter and receiver, with 0.18 mm ² , or more, cable. (Shield wire must be extended with shield wire.)	
Net weight	Emitter: 110 g approx., Receiver: 100 g approx.	Emitter: 70 g approx., Receiver: 70 g approx.	
Accessories	MS-LA3-1 (Sensor head mounting bracket): 1 set for emitter and receiver, Target label: 2 pcs.	MS-LA3-2 (Sensor head mounting bracket): 1 set for emitter and receiver, Target label: 2 pcs.	

Order for the long sensing range type **LA-310** will be stopped by December, 2007.

Note: Where measurement conditions have not been specified precisely, the conditions used were an ambient temperature of +20 $^{\circ}$ C **+68 $^{\circ}$ F**.

SPECIFICATIONS**Amplifiers**

Item	Type	NPN output type	PNP output type
	Model No.	LA-A1	LA-A1P
Applicable sensor heads	LA-310, LA-305		
Supply voltage	12 to 24 V DC \pm 10 % Ripple P-P 10 % or less		
Current consumption	120 mA or less (including sensor heads)		
Comparative outputs (HIGH, LOW)		NPN open-collector transistor <ul style="list-style-type: none"> Maximum sink current: 100 mA Applied voltage: 30 V DC or less (between comparative output and 0 V) Residual voltage: 1.5 V or less (at 100 mA sink current) 0.5 V or less (at 16 mA sink current) 	PNP open-collector transistor <ul style="list-style-type: none"> Maximum source current: 100 mA Applied voltage: 30 V DC or less (between comparative output and +V) Residual voltage: 1.5 V or less (at 100 mA source current) 0.5 V or less (at 16 mA source current)
	Utilization category	DC-12 or DC-13	
	Response time	0.5 ms or less	
	Output operation	HIGH output: ON when the received beam level is equal to or lower than HIGH (Over-dark) level LOW output: ON when the received beam level is equal to or higher than LOW (Under-dark) level	
	Short-circuit protection	Incorporated	
Analog output		Analog voltage <ul style="list-style-type: none"> Output voltage: 1 V (Darkest) to 5 V (Lightest) Output impedance: 75 Ω 	
	Slew rate	8 V/ms or more	
	Temperature characteristics	0.05 % F.S./ $^{\circ}$ C or less	
External synchronization	Incorporated (Either gate trigger or edge trigger is selectable)		
Indicators	Power	Green LED (lights up when the power is ON)	
	Stable incident beam	Three green LEDs (light up in three stages in proportion to the amount of beam received)	
	Operation	Two orange LEDs (light up when High and Low comparative outputs are ON, respectively)	
	External synchronization	Green LED (lights up when the comparative outputs are effective)	
Adjusters	Span	15-turn adjuster sets the span for the analog output voltage	
	Shift	15-turn adjuster sets the offset for the analog output voltage	
	HIGH (Over-dark) level	15-turn adjuster sets the HIGH output threshold level (Over-dark level)	
	LOW (Under-dark) level	15-turn adjuster sets the LOW output threshold level (Under-dark level)	
Environmental resistance	Pollution degree	3 (Industrial environment)	
	Ambient temperature	0 to +50 $^{\circ}$ C +32 to +122 $^{\circ}$F (No dew condensation), Storage: -20 to +70 $^{\circ}$ C -4 to +158 $^{\circ}$F	
	Ambient humidity	35 to 85 % RH, Storage: 35 to 85 % RH	
	EMC	EN 61000-6-2, EN 61000-6-4	
	Voltage withstandability	1,000 V AC for one min. between all supply terminals connected together and enclosure	
	Insulation resistance	20 M Ω , or more, with 250 V DC megger between all supply terminals connected together and enclosure	
	Vibration resistance	10 to 150 Hz frequency, 0.75 mm 0.030 in amplitude in X, Y and Z directions for two hours each	
	Shock resistance	500 m/s ² acceleration (50 G approx.) in X, Y and Z directions for three times each	
Material	Enclosure: Heat-resistant ABS, Terminal cover: Heat-resistant ABS, Front cover: Polycarbonate		
Cable	0.22 mm ² (shield wire: 0.15 mm ²) 7-core composite cabtyre cable, 2 m 6.562 ft long		
Cable extension (Note 2)	Extension up to total 50 m 164.042 ft is possible with 0.22 mm ² , or more, cable. (Shield wire must be extended with 0.15 mm ² , or more, shield wire.)		
Weight	Net weight: 200 g approx.		
Accessory	Adjusting screwdriver: 1 pc.		

Notes: 1) Where measurement conditions have not been specified precisely, the conditions used were an ambient temperature of +20 $^{\circ}$ C **+68 $^{\circ}$ F**.

2) This product is CE compliant and complies with EMC directives. EN 61000-6-2 is the applicable standard that covers immunities relating to use of this product, but in order to comply with this standard, the following conditions must be satisfied.

Conditions

- The amplifier should be connected less than 10 m 32.808 ft from the power supply.
- The signal line to connect with the amplifier should be less than 30 m 98.425 ft.

- FIBER SENSORS
- LASER SENSORS
- PHOTO-ELECTRIC SENSORS
- MICRO PHOTO-ELECTRIC SENSORS
- AREA SENSORS
- SAFETY COMPONENTS
- PRESSURE SENSORS
- INDUCTIVE PROXIMITY SENSORS
- PARTICULAR USE SENSORS
- SENSOR OPTIONS
- WIRE-SAVING SYSTEMS
- MEASUREMENT SENSORS
- STATIC CONTROL DEVICES
- LASER MARKERS
- Selection Guide
- Laser Displacement
- HL-C2**
- HL-C1
- LM10
- Magnetic Displacement
- GP-X
- GP-A
- Collimated Beam Sensors
- HL-T1
- LA-300**
- LA
- Other Products

I/O CIRCUIT DIAGRAMS

LA-A1 NPN output type

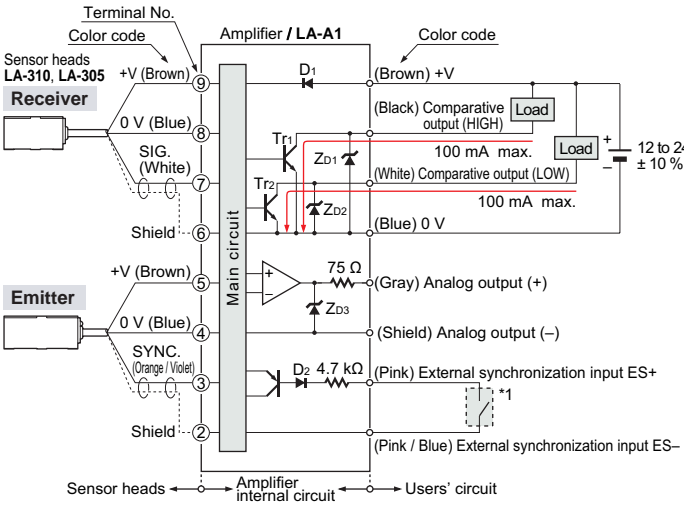

Symbols ... D1: Reverse supply polarity protection diode
 D2: Input protection diode
 ZD1, ZD2, ZD3: Surge absorption zener diode
 Tr1, Tr2: NPN output transistor

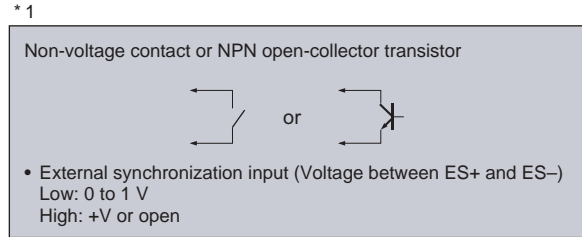

Notes: 1) When ES+ (pink) and ES- (pink / blue) of external synchronization input are connected, both HIGH and LOW comparative outputs are triggered in the mode selected by the external synchronization selection switch. If the external synchronization function is not used, always short-circuit ES+ and ES- and set the external synchronization selection switch to gate trigger.
 2) To use the analog output (gray), choose a device with an input impedance of 1 MΩ, or more, and connect the shield wire of the analog output to 0 V (common input) of the device.
 3) Insulate all unused wires individually to avoid miscontact.

LA-A1P PNP output type

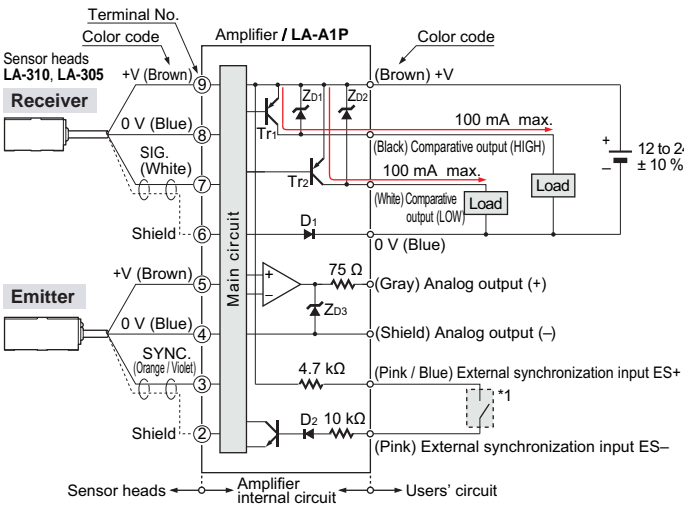

Symbols ... D1: Reverse supply polarity protection diode
 D2: Input protection diode
 ZD1, ZD2, ZD3: Surge absorption zener diode
 Tr1, Tr2: PNP output transistor

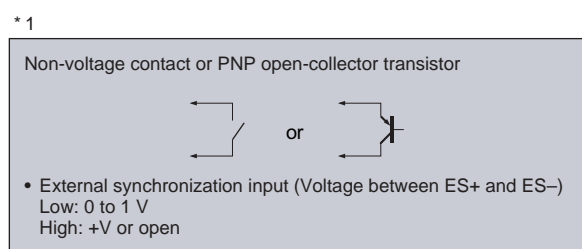

Notes: 1) When ES+ (pink / blue) and ES- (pink) of external synchronization input are connected, both HIGH and LOW comparative outputs are triggered in the mode selected by the external synchronization selection switch. If the external synchronization function is not used, always short-circuit ES+ and ES- and set the external synchronization selection switch to gate trigger.
 2) To use the analog output (gray), choose a device with an input impedance of 1 MΩ, or more, and connect the shield wire of the analog output to 0 V (common input) of the device.
 3) Insulate all unused wires individually to avoid miscontact.

SENSING CHARACTERISTICS (TYPICAL)

LA-310

Long sensing range type

Correlation between transverse deviation and output voltage

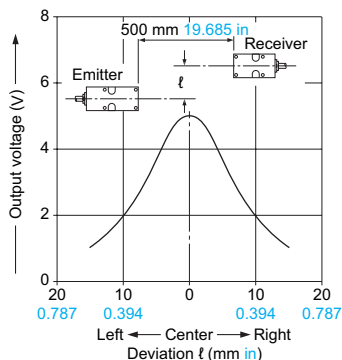

Correlation between interrupted beam width and output voltage

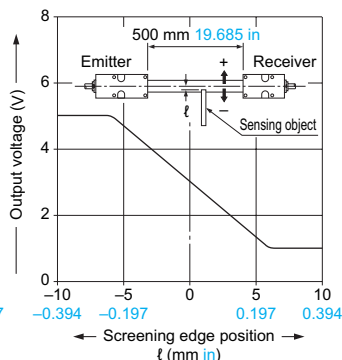

Correlation between ambient temperature and output voltage variation rate

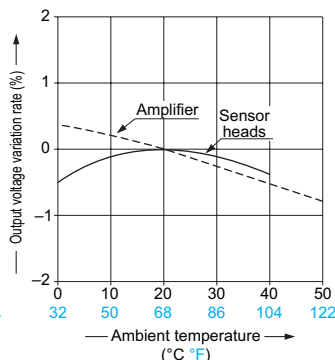

LA-305

Slim type

Correlation between transverse deviation and output voltage

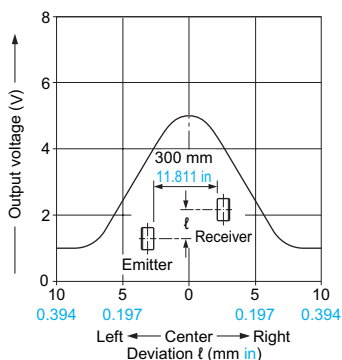

Correlation between interrupted beam width and output voltage

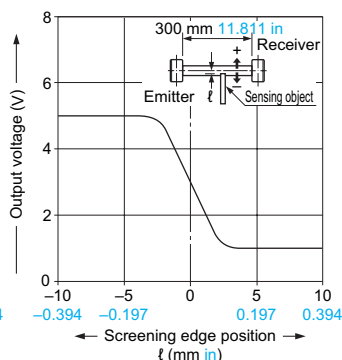

Correlation between ambient temperature and output voltage variation rate

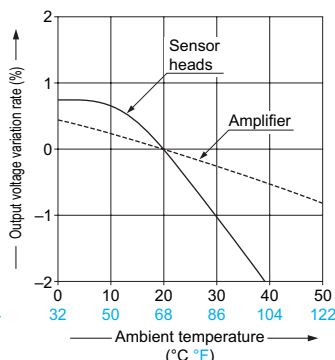

PRECAUTIONS FOR PROPER USE

Refer to p.1027 for general precautions.



- Never use this product as a sensing device for personnel protection.
- In case of using sensing devices for personnel protection, use products which meet laws and standards, such as OSHA, ANSI or IEC etc., for personnel protection applicable in each region or country.

Mounting

Amplifier

<Mounting on DIN rail>

- ① Make sure that the mounting stopper is latched inside. Hook the front side of the controller mounting section on the 35 mm 1.378 in width DIN rail.
 - ② Snap the controller down on the 35 mm 1.378 in width DIN rail.
- *To remove, insert a "minus" screwdriver into the mounting stopper and pull out.

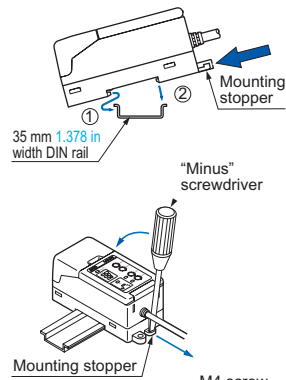

<Mounting with screws>

- Use two commercially available M4 screws. The tightening torque should be 1.2 N·m or less.

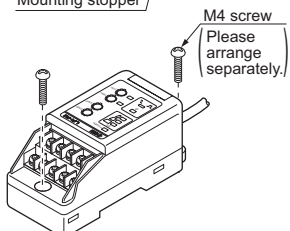

Sensor heads

- The projected LED beam has a directionality. Hence, take care of emitter and receiver mounting direction.

LA-310

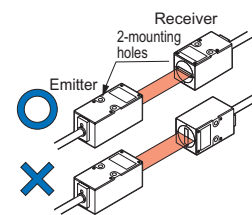

LA-305

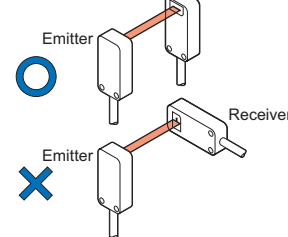

- The tightening torque should be 0.5 N·m or less.

LA-310

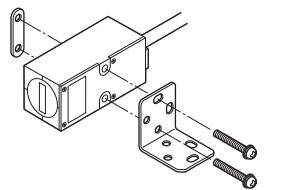

Sensor head mounting bracket for LA-310 MS-LA3-1 (Accessory)

LA-305

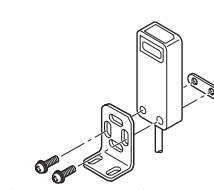

Sensor head mounting bracket for LA-305 MS-LA3-2 (Accessory) (Note)

Note: When carrying out high accuracy sensing with LA-305, install the mounting bracket on the front face as shown in the above figure.

- FIBER SENSORS
- LASER SENSORS
- PHOTO-ELECTRIC SENSORS
- MICRO PHOTO-ELECTRIC SENSORS
- AREA SENSORS
- SAFETY COMPONENTS
- PRESSURE SENSORS
- INDUCTIVE PROXIMITY SENSORS
- PARTICULAR USE SENSORS
- SENSOR OPTIONS
- WIRE- SAVING SYSTEMS
- MEASUREMENT SENSORS
- STATIC CONTROL DEVICES
- LASER MARKERS

- Selection Guide
- Laser Displacement
- HL-C2
- HL-C1
- LM10
- Magnetic Displacement
- GP-X
- GP-A
- Collimated Beam Sensors
- HL-T1
- LA-300
- LA
- Other Products

PRECAUTIONS FOR PROPER USE

Refer to p.1027 for general precautions.

- FIBER SENSORS
- LASER SENSORS
- PHOTO-ELECTRIC SENSORS
- MICRO PHOTO-ELECTRIC SENSORS
- AREA SENSORS
- SAFETY COMPONENTS
- PRESSURE SENSORS
- INDUCTIVE PROXIMITY SENSORS
- PARTICULAR USE SENSORS
- SENSOR OPTIONS
- WIRE-SAVING SYSTEMS
- MEASUREMENT SENSORS
- STATIC CONTROL DEVICES
- LASER MARKERS

External synchronization

- The external synchronization input controls the timing or the effective duration of the two comparative outputs. Either edge or gate trigger is selectable.

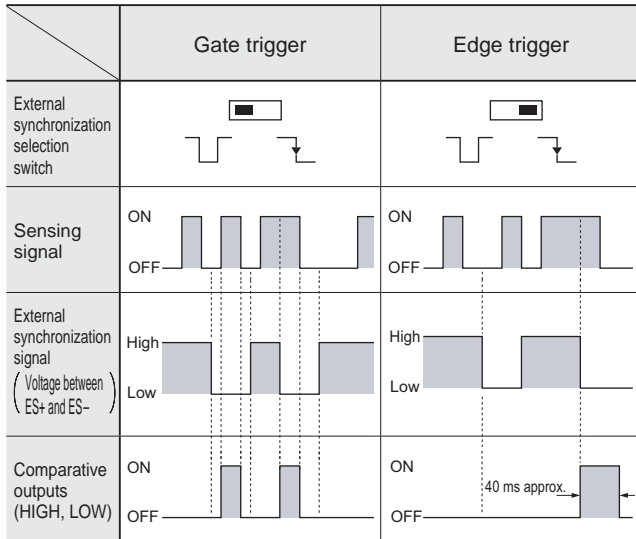

External synchronization input signal: Low ... 0 to 1 V, High ... +V or open

Note: If external synchronization is not used, set the external synchronization selection switch on "Gate trigger" and short-circuit the external synchronization inputs (ES+ and ES-).

Others

- The sensor's output is proportional to the amount of the LED light received. Since there is some variation in the light intensity at the center and the periphery of the sensing area, take care that "output = dimension" may not hold.
- For stable operation, use the sensor 10 min., or more, after switching on the power supply.
- Keep the front faces of the sensor heads free of dust, dirt, metal powder, etc. Should the faces be covered with it, deteriorating its performance, wipe them clean with a soft cloth or blown air.

DIMENSIONS (Unit: mm in)

The CAD data in the dimensions can be downloaded from the SUNX website.

LA-310

Sensor head

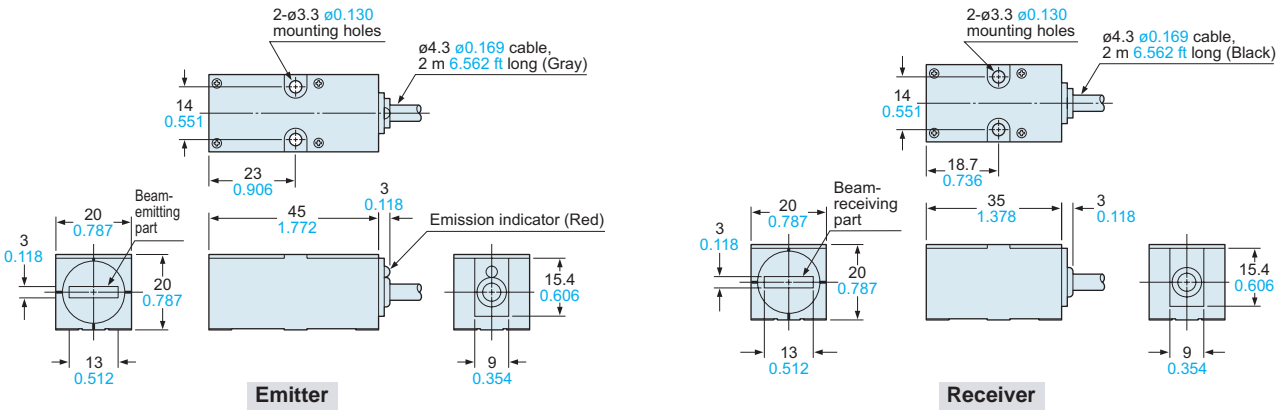

LA-305

Sensor head

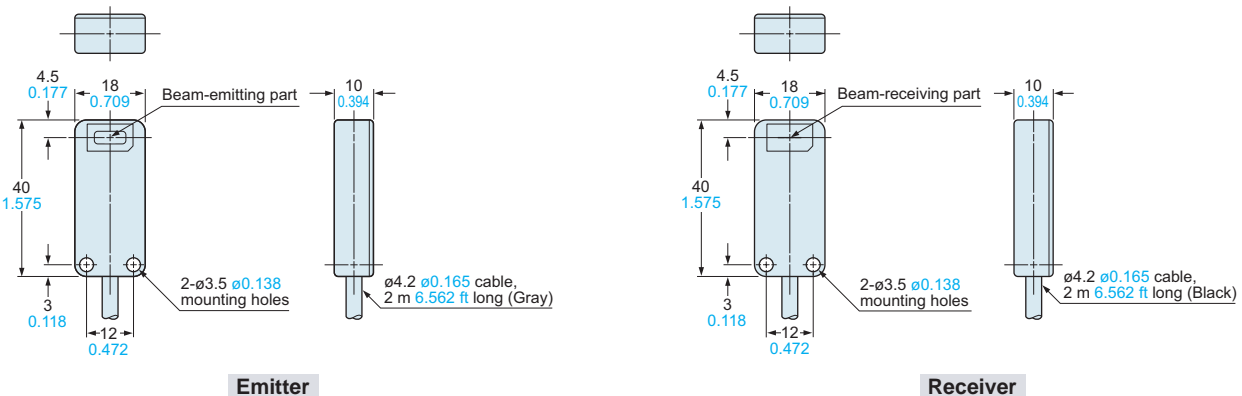

DIMENSIONS (Unit: mm in) The CAD data in the dimensions can be downloaded from the SUNX website.

LA-A1 LA-A1P

Amplifier

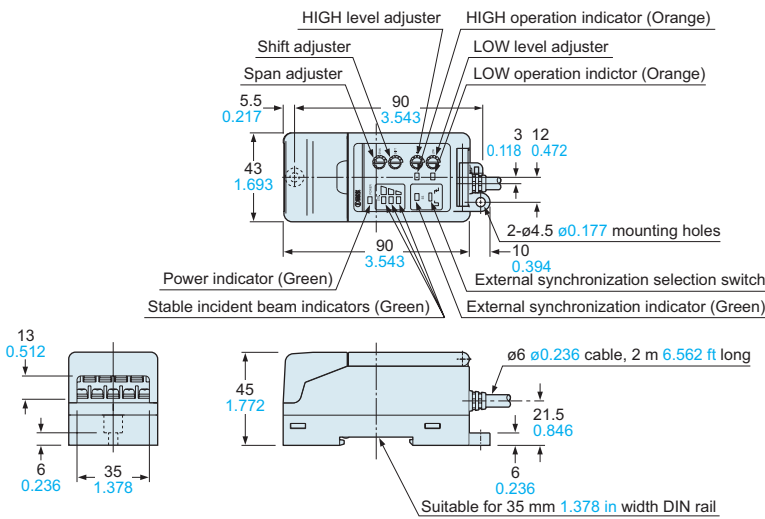

MS-LA3-1

Sensor head mounting bracket for **LA-310** (Accessory for **LA-310**)

Assembly dimensions

Mounting drawing with the receiver

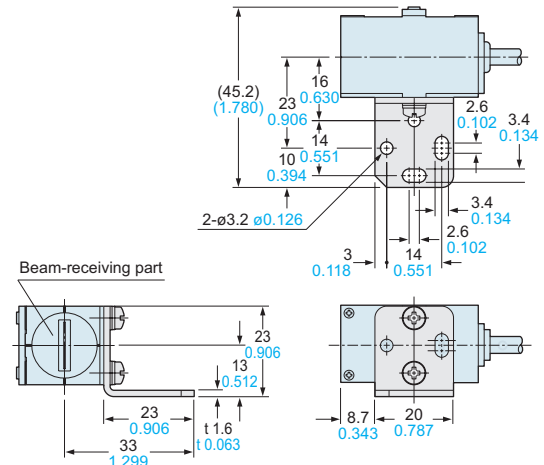
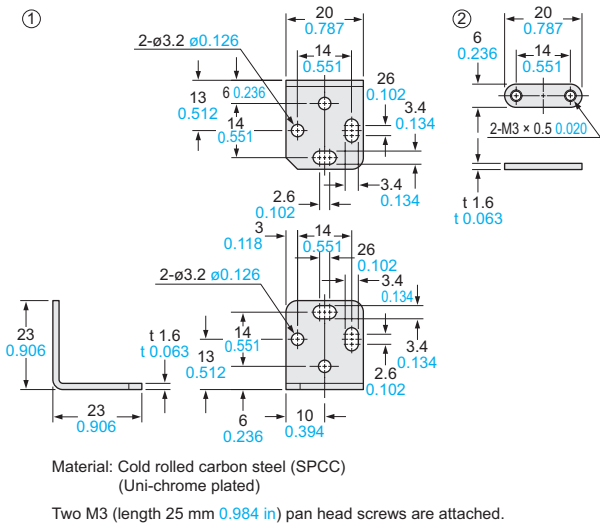

MS-LA3-2

Sensor head mounting bracket for **LA-305** (Accessory for **LA-305**)

Assembly dimensions

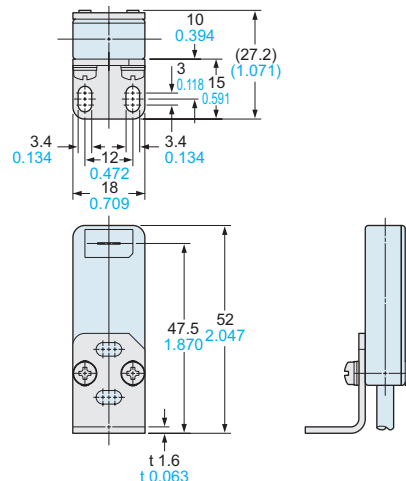
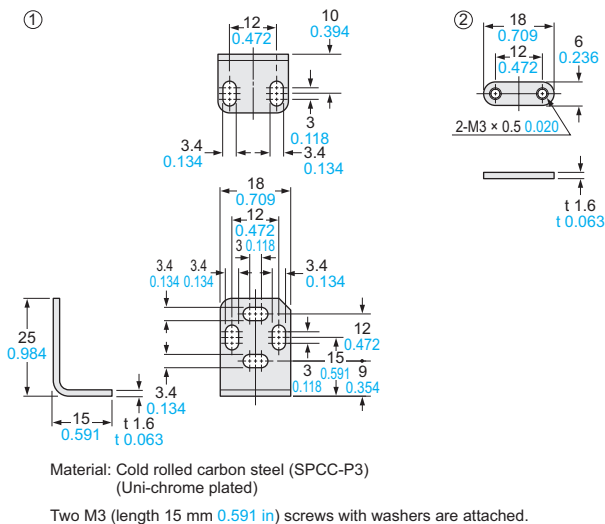

- FIBER SENSORS
- LASER SENSORS
- PHOTO-ELECTRIC SENSORS
- MICRO PHOTO-ELECTRIC SENSORS
- AREA SENSORS
- SAFETY COMPONENTS
- PRESSURE SENSORS
- INDUCTIVE PROXIMITY SENSORS
- PARTICULAR USE SENSORS
- SENSOR OPTIONS
- WIRE-SAVING SYSTEMS
- MEASUREMENT SENSORS
- STATIC CONTROL DEVICES
- LASER MARKERS
- Selection Guide
- Laser Displacement
- HL-C2**
- HL-C1**
- LM10**
- Magnetic Displacement
- GP-X**
- GP-A**
- Collimated Beam Sensors
- HL-T1**
- LA-300**
- LA**
- Other Products