



CY3280-MBR CapSense[®] Express[™] with SmartSense[™] Auto-Tuning Kit Guide

Doc. # 001-64772 Rev. *E

Cypress Semiconductor
198 Champion Court
San Jose, CA 95134-1709
Phone (USA): 800.858.1810
Phone (Intl): 408.943.2600
<http://www.cypress.com>

Copyrights

© Cypress Semiconductor Corporation, 2010-2015. The information contained herein is subject to change without notice. Cypress Semiconductor Corporation assumes no responsibility for the use of any circuitry other than circuitry embodied in a Cypress product. Nor does it convey or imply any license under patent or other rights. Cypress products are not warranted nor intended to be used for medical, life support, life saving, critical control or safety applications, unless pursuant to an express written agreement with Cypress. Furthermore, Cypress does not authorize its products for use as critical components in life-support systems where a malfunction or failure may reasonably be expected to result in significant injury to the user. The inclusion of Cypress products in life-support systems application implies that the manufacturer assumes all risk of such use and in doing so indemnifies Cypress against all charges.

Any Source Code (software and/or firmware) is owned by Cypress Semiconductor Corporation (Cypress) and is protected by and subject to worldwide patent protection (United States and foreign), United States copyright laws and international treaty provisions. Cypress hereby grants to licensee a personal, non-exclusive, non-transferable license to copy, use, modify, create derivative works of, and compile the Cypress Source Code and derivative works for the sole purpose of creating custom software and or firmware in support of licensee product to be used only in conjunction with a Cypress integrated circuit as specified in the applicable agreement. Any reproduction, modification, translation, compilation, or representation of this Source Code except as specified above is prohibited without the express written permission of Cypress.

Disclaimer: CYPRESS MAKES NO WARRANTY OF ANY KIND, EXPRESS OR IMPLIED, WITH REGARD TO THIS MATERIAL, INCLUDING, BUT NOT LIMITED TO, THE IMPLIED WARRANTIES OF MERCHANTABILITY AND FITNESS FOR A PARTICULAR PURPOSE. Cypress reserves the right to make changes without further notice to the materials described herein. Cypress does not assume any liability arising out of the application or use of any product or circuit described herein. Cypress does not authorize its products for use as critical components in life-support systems where a malfunction or failure may reasonably be expected to result in significant injury to the user. The inclusion of Cypress' product in a life-support systems application implies that the manufacturer assumes all risk of such use and in doing so indemnifies Cypress against all charges.

Use may be limited by and subject to the applicable Cypress software license agreement.

PSoC and CapSense are registered trademarks of Cypress Semiconductor Corporation. PSoC Designer, SmartSense, and CapSense Express are trademarks of Cypress Semiconductor Corporation. All other products and company names mentioned in this document may be the trademarks of their respective holders.

Purchase of I2C components from Cypress or one of its sublicensed Associated Companies conveys a license under the Philips I2C Patent Rights to use these components in an I2C system, provided that the system conforms to the I2C Standard Specification as defined by Philips. As from October 1st, 2006 Philips Semiconductors has a new trade name - NXP Semiconductors.

Contents



1. Introduction	5
1.1 Kit Contents	5
1.2 CY3280-MBR Kit Board Features.....	5
1.3 Factory Default Configuration	5
1.4 CY3280-MBR Kit Documents	6
1.5 Document Revision History	6
1.6 Documentation Conventions	6
2. Kit Operation	7
2.1 Power Supply.....	8
2.2 System Block Diagram and Operation.....	8
2.3 Controller Pin Assignment Details	9
2.4 Connector Details	10
2.4.1 SmartSense Evaluation Header (Connector J5).....	10
2.4.2 Expansion Connector One (Connector J1)	10
2.4.3 Expansion Connector Two (Connector J2)	11
2.5 Power the Kit	11
2.5.1 Insert Battery.....	11
2.5.2 Default Kit Configuration	12
3. Kit Features	13
3.1 CY8CMBR2044 CapSense Controller Features.....	13
3.2 SmartSense Feature.....	13
3.2.1 Enable SmartSense Feature.....	13
3.2.2 Test CapSense Buttons with SmartSense Feature Enabled.....	13
3.3 Toggle Feature	15
3.3.1 Test CapSense Buttons with Toggle Feature Disabled	15
3.3.2 Enable Toggle Feature.....	15
3.3.3 Test CapSense Buttons with Toggle Feature Enabled.....	15
3.4 Flanking Sensor Suppression (FSS) Feature	16
3.4.1 Test CapSense Buttons with FSS Feature Disabled.....	17
3.4.2 Enable FSS Feature.....	17
3.4.3 Test CapSense Buttons with FSS Feature Enabled.....	17
3.5 Toggle and FSS Features Combined	18
3.5.1 Test CapSense Buttons FSS and Toggle Features Disabled.....	18
3.5.2 Enable Both FSS and Toggle Features.....	18
3.5.3 Test CapSense Buttons with FSS and Toggle Features Enabled	19
3.6 LED On Time Feature.....	19
3.6.1 Test CapSense Buttons with LED On Time Feature Disabled	19
3.6.2 Enable LED On Time Feature	20
3.6.3 Test CapSense Buttons with LED On Time Feature Enabled	20
3.7 Scan Rate/Sleep Feature	21

- 3.7.1 Test CapSense Buttons with Sleep Feature Disabled 21
- 3.7.2 Enable Sleep Feature 21
- 3.7.3 Test CapSense Buttons with Sleep Feature Enabled 22
- 3.8 ARST Feature..... 22
 - 3.8.1 Enable/Disable ARST Feature..... 22
 - 3.8.2 Test CapSense Buttons with ARST Feature Enabled..... 23
- 3.9 System Diagnostic Feature 23
 - 3.9.1 Enable System Diagnostics Feature..... 23
 - 3.9.2 Test System Diagnostics Feature - CapSense Button Short to Ground 23
 - 3.9.3 Test System Diagnostics Feature - CapSense Button to Button Short 24

- A. Appendix 25**
 - A.1 Board Schematics 25
 - A.2 Board Layouts 27
 - A.3 Bill of Materials 29
 - A.4 Frequently Asked Questions 30

1. Introduction



Thank you for your interest in the CY3280-MBR CapSense® Express™ with SmartSense™ Auto-Tuning Kit. The kit is designed to showcase the abilities of the configurable capacitive sensing controller CY8CMBR2044. This controller is equipped with SmartSense, which allows you to go from prototyping to mass production without re-tuning for manufacturing variations in printed circuit board (PCB) and/or overlay material properties.

1.1 Kit Contents

- CY3280-MBR printed circuit assembly (PCA)
- Two AAA batteries
- Clear acrylic overlays, of 1-mm and 3-mm thickness, with matt finish on one side (a 2-mm overlay is fixed on the kit)
- Axial capacitors 10 pF, 22 pF, and 68 pF
- Quick Start Guide

1.2 CY3280-MBR Kit Board Features

- Four CapSense buttons of different dimensions
- Four LEDs connected to general-purpose output pins
- CapSense-based power button and power indicator LED
- Operates from external power supply and battery
- Expansion slots, allowing I/O to expand to external boards

1.3 Factory Default Configuration

When shipped, a 2-mm overlay is already fixed on the kit. The SW1 switch is in the Toggle On position and the SW2 switch is in the Sleep Off position. The LED turns on when you touch the corresponding button. The kit is configured to provide an approximate battery life of one year in standby mode. If deep-sleep mode of the CapSense controller is enabled, current consumption can be reduced to 100 nA and the battery life increases accordingly. Deep-sleep mode is not enabled in this kit because a host controller is recommended to enable this mode.

Note The demonstration buttons and LEDs are inactive when the power LED is off.

1.4 CY3280-MBR Kit Documents

Visit www.cypress.com/?rID=47022 to download the following kit documents:

- Quick Start Guide
- Kit User Guide
- Release Notes

The following resources can also be used for reference:

- [CY8CMBR2044 CapSense Design Guide](#)
- [CY8CMBR2044 Datasheet](#)
- [CY8CMBR2044 Design Toolbox](#)

1.5 Document Revision History

Table 1-1. Revision History

Revision	PDF Creation Date	Origin of Change	Description of Change
**	11/25/2010	BVI	New kit guide.
*A	05/06/2011	RKPM	Removed all reference to 33 pF capacitance. Changed the maximum parasitic capacitance from 41 to 40 pF
*B	03/15/2012	RKPM	Added Getting Started chapter
*C	12/04/2012	SLAN	No technical updates.
*D	06/06/2013	ZINE	Added section 1.4. Updated sections 4.2.2 and 4.4. Renamed FMEA as System Diagnostics; renamed the Delay Off feature as LED On time. Updated section 4.8.1 with information on disabling ARST. Removed the Getting Started chapter.
*E	12/17/2015	SLAN	No technical updates. Completing Sunset Review.

1.6 Documentation Conventions

Table 1-2. Document Conventions for Guides

Convention	Usage
Courier New	Displays file locations, user entered text, and source code: C:\...cd\icc\
<i>Italics</i>	Displays file names and reference documentation: Read about the <i>sourcefile.hex</i> file in the <i>PSoC Designer User Guide</i> .
[Bracketed, Bold]	Displays keyboard commands in procedures: [Enter] or [Ctrl] [C]
File > Open	Represents menu paths: File > Open > New Project
Bold	Displays commands, menu paths, and icon names in procedures: Click the File icon and then click Open .
Times New Roman	Displays an equation: $2 + 2 = 4$
Text in gray boxes	Describes Cautions or unique functionality of the product.

2. Kit Operation



The CY3280-MBR kit has four CapSense buttons and a CapSense-based power button. [Figure 2-1](#) illustrates these buttons: demonstration buttons (BTN0 to BTN3) and the POWER BUTTON. The kit is powered by two AAA batteries, which are placed below the kit in the battery holder. The configurable CY8CMBR2044 CapSense controller supports multiple features. The kit includes the hardware support required to successfully demonstrate each feature; see the [Kit Features chapter on page 13](#) for a demonstration of each feature.

The board has three connectors. Connector J5 demonstrates the SmartSense feature; connectors J1 and J2 provide external power to the kit and connect output signals for the CapSense controller to host systems.

Touch the power button first and ensure that the power LED turns on. Each CapSense button is mapped to an LED (LED0 to LED3) such that activation of each button can be verified visually by monitoring the LED status. Active status of the CapSense buttons are indicated by the ON status of the LEDs.

Figure 2-1. Top and Bottom Views of Kit

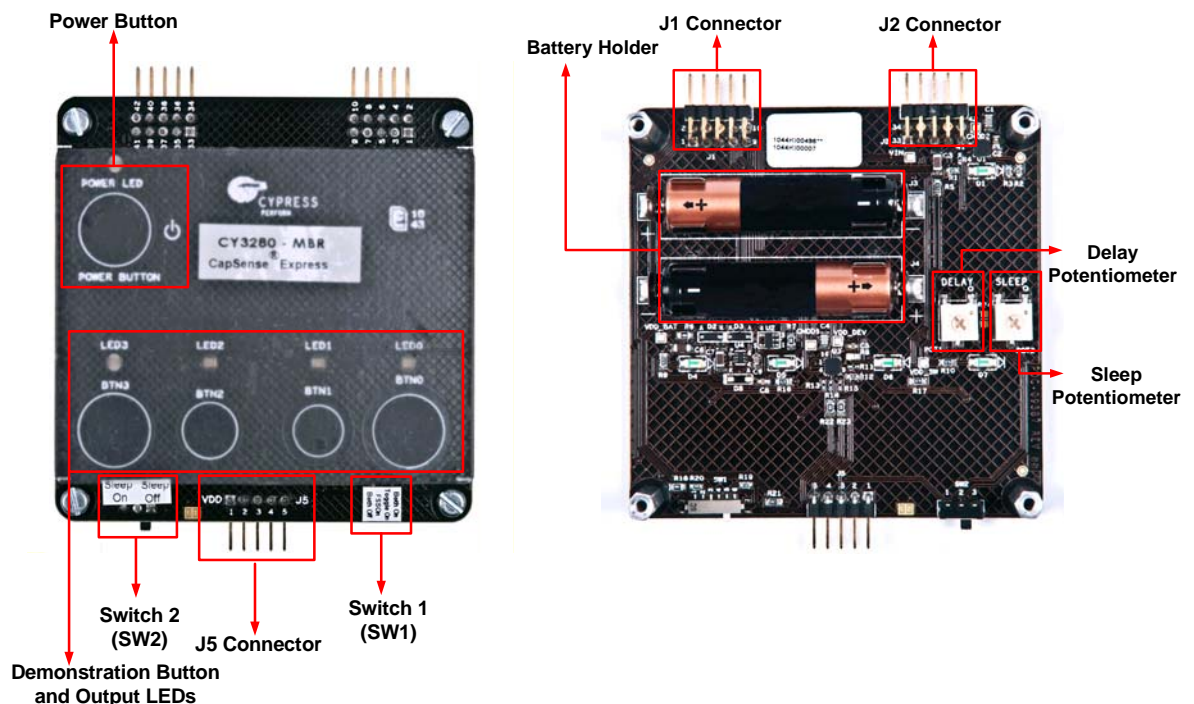

2.1 Power Supply

The CY3280-MBR kit can be powered using two sources: external power supply and onboard battery power.

- Onboard battery power supply (place AAA batteries in the battery holder)
- External supply (use pins 41 and 39 of connector J2 to connect VDD and GND, respectively)
- External supply (use pins 1 and 2 of connector J5 to connect VDD and GND, respectively)

External power supplied through J2 is gated by the CapSense-based power button; external power supplied through J5 is not gated.

While the external power option supports all operating power supply from 1.71 V to 3.6 V, the onboard battery power supply provides only 3-V operation.

For the kit to work, at least one power source should be active. The CY8CMBR2044 CapSense controller is powered 200 mV less than what is supplied to the power supply connector J2 due to voltage drop across regulator circuitry. External supply should be greater than 2.0 V and lesser than 3.8 V to provide 1.71 V to 3.6 V supply to the CapSense controller.

2.2 System Block Diagram and Operation

Figure 2-2 shows the block diagram of the CY3280-MBR kit. The block diagram has two main sections, power supply and CapSense controller. The power supply section is based on the external and onboard battery power. Power-on and power-off control is implemented using a CapSense-based power button, which is activated every time the kit is powered. The CapSense controller is powered only if you touch the CapSense power button to turn on the kit.

Figure 2-2. Block Diagram of CY3280-MBR Kit

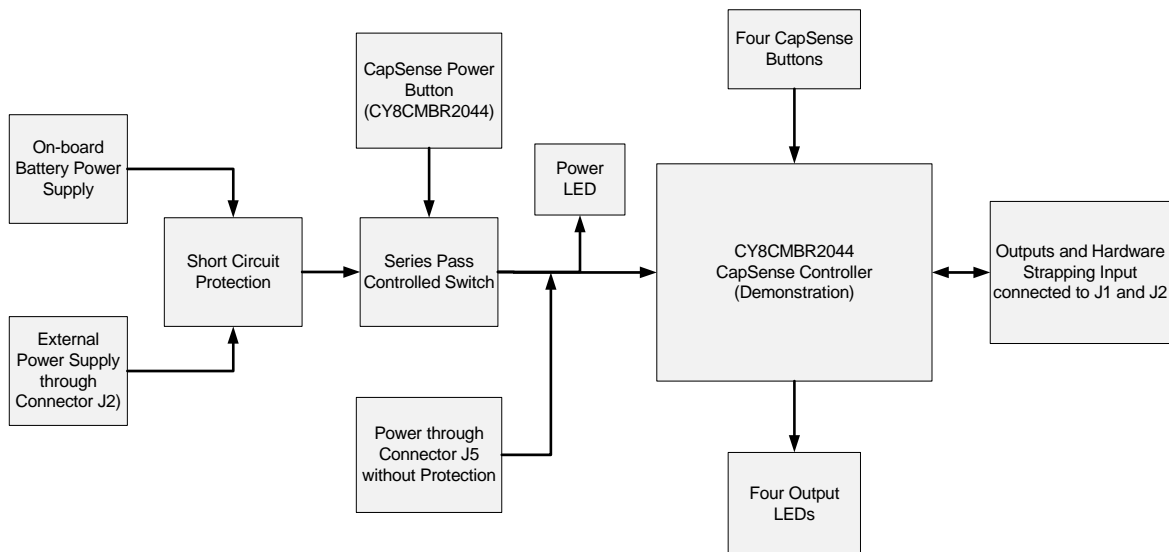

The kit can be powered from three sources, which include power from onboard battery and external power through the J2 and J5 connectors. Two power sources are connected to a series pass switch, which is controlled by the CapSense-based power button. An LED is used to indicate the power on condition of the kit. A protection circuit is provided to prevent damage if both these sources are connected at the same time. The protection circuit allows only one power supply to be active at a time. The supply that has higher potential powers the kit. Therefore, to power the kit with less than 3-V external power, remove the battery. To power the kit from the battery, external power supply should not be connected or should not be higher than the battery voltage (3 V).

The third power source option is through the J5 connector; this power supply does not have a protection circuit. It is recommended not to power the kit from any other source when the external power through J5 is connected.

Four CapSense buttons and receptive LEDs are connected to the CapSense controller used for demonstration. The output signals and hardware strapping inputs are also connected to the J1 and J2 connectors. This helps to connect them to the host, monitor status, and control the CapSense controller.

2.3 Controller Pin Assignment Details

The following table shows the pin assignment of the CapSense controller. To learn how to assign pins for your design and recommendations on pin selection, see the [CY8CMBR2044 datasheet](#).

Pin	Label	Description	Unused
1	GPO1	GPO activated by CS1	Leave open
2	GPO0	GPO activated by CS0	Leave open
3	Toggle/FSS	Controls FSS and toggle features	Ground
4	Delay	Controls LED On time	Ground
5	CS0	CapSense input 0	Ground
6	CS1	CapSense input 1	Ground
7	V _{SS}	Ground	
8	CS2	CapSense input 2	Ground
9	ARST	Controls auto reset delay	Leave open
10	CS3	CapSense input 3	Ground
11	XRES	Device reset, active high, with internal pull down	Leave open
12	Scan Rate/Sleep	Controls scan rate and deep sleep	Ground
13	V _{DD}	Power	
14	GPO3	GPO activated by CS3	Leave open
15	CMOD	External integrating capacitor, connect a 2.2 nF ($\pm 5\%$) between this pin and ground	
16	GPO2	GPO activated by CS2	Leave open

2.4 Connector Details

2.4.1 SmartSense Evaluation Header (Connector J5)

Various signals are connected to the J5 connector, as shown in the following table. For more information on each signal, see the schematics of the CY3280-MBR kit.

VDD and GND are connected to pins 1 and 2 on this connector such that the external power supply can be connected to the kit, if required. This power supply is not gated through CapSense-based power buttons; therefore, the same voltage applied on the connector reaches the CapSense controller. When the kit is powered through the J5 connector, only the CapSense controller is powered; LEDs and other kit parts do not function. It is not recommended to power the kit through J5 connector and one of the gated power sources.

Pin 3 of the J5 connector is connected to the reset pin (XRES) of the CapSense controller; providing logic high signal to this pin resets the CapSense controller.

The remaining two pins (4 and 5) are connected to CapSense sensors BTN1 and BTN2, respectively. This allows the option to increase the sensor capacitance and evaluate the SmartSense-based auto-tuning feature of CY8CMBR2044.

Table 2-1. Connector J5 (SmartSense Evaluation Header)

J5 - 1	VDD (external only to CapSense controller)
J5 - 2	GND
J5 - 3	XRES
J5 - 4	CS1 (BTN1)
J5 - 5	CS2 (BTN2)

2.4.2 Expansion Connector One (Connector J1)

All the GPO signals are connected to the J1 connector, allowing the CapSense output signals to be interfaced with host controllers. This is a good option to build a mock design for testing purposes. All hardware strapping inputs of CY8CMBR2044, except ARST, are connected to the J1 connector. These signals can be used to measure the value of the strapping input resistor configured.

One end of the Scan Rate/Sleep resistor is connected to pin 1 of J1. When the sleep mode is enabled by setting SW2 to Sleep On, the CapSense controller can be made to work in deep-sleep mode by providing the recommended logic signal on pin 1 of J1. See the [CY8CMBR2044 datasheet](#) for details on how to activate deep-sleep mode and reduce the current consumption of the CapSense controller to 100 nA.

Table 2-2. Connector J1 (Expansion Connector 1)

J1 - 1	SLEEP_CNT (control input of Scan Rate/Sleep)
J1 - 2	XRES
J1 - 3	DELAY
J1 - 4	TOGGLE/FSS
J1 - 5	GND
J1 - 6	GND
J1 - 7	GPO 0
J1 - 8	GPO 1
J1 - 9	GPO 2
J1 - 10	GPO 3

2.4.3 Expansion Connector Two (Connector J2)

Using the VDD and GND signals available in the J2 connector, you can power the kit from an external power supply. Note that this power supply is gated through the CapSense-based power button circuitry. The CapSense controller receives 200 mV less than what is applied to the connector due to the drop across the power button switch circuitry. External supply should be greater than 2.0 V and less than 3.8 V to provide 1.71 V to 3.6 V supply to the CapSense Controller.

Connector J2 (Expansion Connector -2)

J2-33	ARST
J2-34	Not Connected
J2-35	GND
J2-36	GND
J2-37	Not Connected
J2-38	Not Connected
J2-39	GND
J2-40	GND
J2-41	VDD (External - Gated by the power button
J2-42	Not Connected

2.5 Power the Kit

The following steps provide detailed instructions to power the kit. Note that these instructions are available in brief in the quick start guide.

2.5.1 Insert Battery

Two AAA size batteries are provided with the kit. Insert these batteries in the battery holder below the kit. Ensure the polarity of the batteries, as shown in the following figure.

Figure 2-3. Insert Batteries

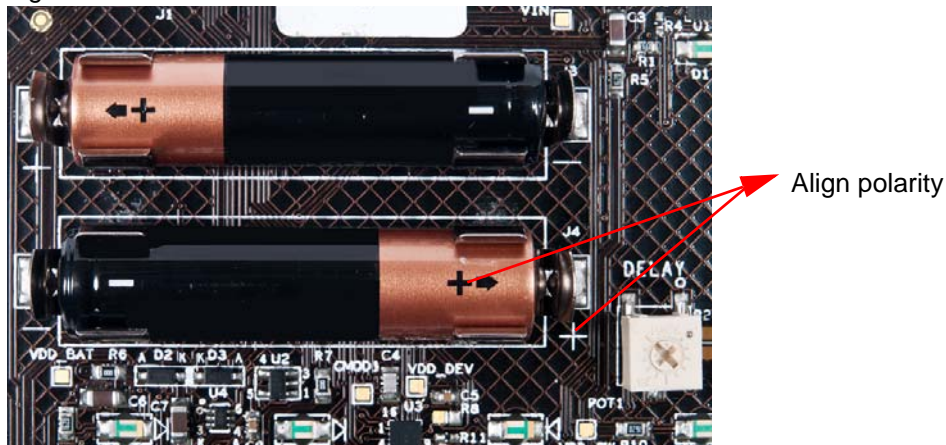

2.5.2 Default Kit Configuration

Ensure that the SW1 switch is in Toggle On position and the SW2 switch is in Sleep Off position. Turn the 'Delay' and 'Sleep' potentiometers to extreme right to disable the 'LED On Time' and 'Sleep' features of the CapSense controller.

Figure 2-4. Default Configuration

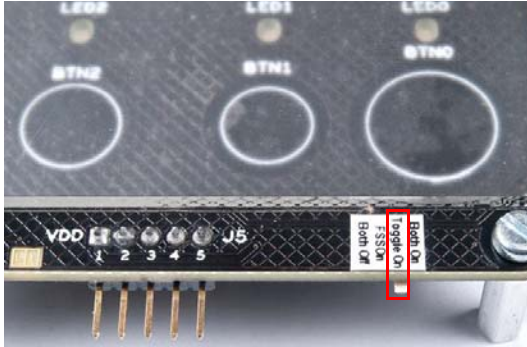

1. SW1 in Toggle On position



2. SW2 in Sleep Off position

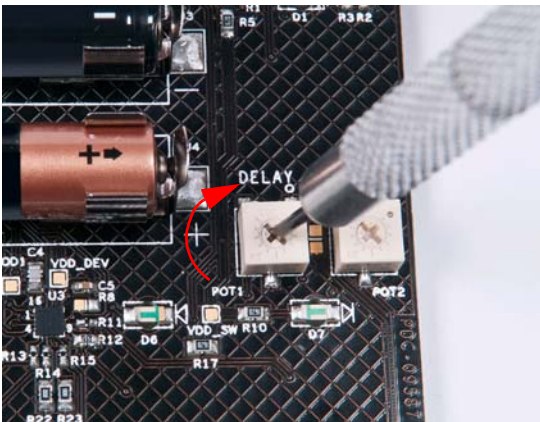

3. Turn 'DELAY' potentiometer to extreme right

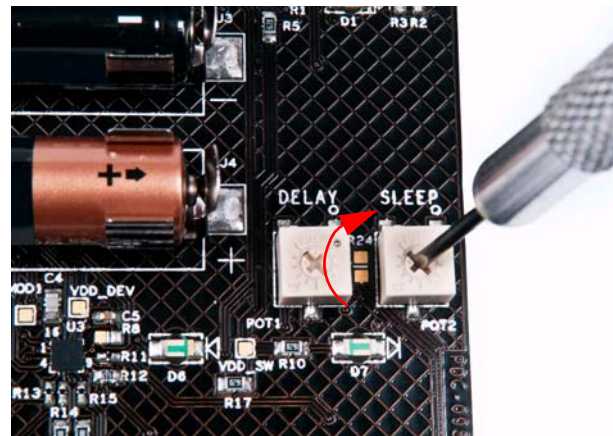

4. Turn 'SLEEP' potentiometer to extreme right

3. Kit Features



This chapter demonstrates the main features of the CY8CMBR2044 CapSense controller using the CY3280-MBR kit.

3.1 CY8CMBR2044 CapSense Controller Features

The CY8CMBR2044 has the following features:

- SmartSense
- Toggle
- Flanking sensor suppression (FSS)
- LED on time
- Scan rate/sleep
- Auto reset (ARST)

Refer to the [CY8CMBR2044 datasheet](#) for more details on these features.

Note All features of the CY8CMBR2044 CapSense controller can be enabled together. For ease of demonstration, each feature is enabled separately in this document.

3.2 SmartSense Feature

This section demonstrates the SmartSense feature of CY8CMBR2044 using the CY3280-MBR kit. Before proceeding, power the kit in default mode by following the steps in section [2.5 Power the Kit on page 11](#).

3.2.1 Enable SmartSense Feature

The CY8CMBR2044 CapSense controller is built around the robust CapSense sigma delta (CSD) capacitive sensing method and patented SmartSense auto-tuning algorithm. No action is required to enable the SmartSense feature in the controller; it is enabled automatically on power-up.

3.2.2 Test CapSense Buttons with SmartSense Feature Enabled

Touch any CapSense button; the respective LED turns on. When the finger is released, the LED turns off. Connect the 10-pF capacitor provided with the kit to the J5 connector, the mark on the capacitor connector facing up. This increases the parasitic capacitance of the CS2 sensor input, which is connected to the BTN2 sensor.

Press the power button to turn off the kit; press again to turn on power. Automatic self-tuning is performed only on power-up and not during run time.

Touch BTN2; there is no difference in the way it works. Note that although the parasitic capacitance of the sensor is increased, the sensor continues to work with automated tuning.

The overlays provided with the kit can also be used to demonstrate the SmartSense Auto-tuning feature. Follow these steps to use the kit with the different overlays provided with the kit.

1. Touch the power button to turn off the kit.
2. Put the 1-mm overlay on top of the existing 2-mm overlay on the kit.
3. Touch the power button again to turn on the kit.
4. Touch any button; the respective LED turns on.
5. Repeat steps 1 to 4 with the 3-mm overlay instead of the 1-mm overlay.

Observe that SmartSense Auto-tuning automatically tunes the board for the increase in capacitance due to the increase in overlay thickness. Every time an overlay is changed, the CapSense controller is reset using XRES or the power is toggled to ensure that auto-tuning takes place. The increased capacitance may be interpreted as a finger touch before reset.

Note For a button sensor to work with an overlay of a specific thickness, the button should have the required diameter. To support a particular overlay thickness, the correct value of the button diameter should be selected in your design. To find the required button diameter for a particular overlay thickness, refer to the [CY8CMBR2044 Design Toolbox](#).

- The diameter of BTN1 and BTN2 is not enough to support a 5-mm overlay. You may observe poor sensitivity on these buttons with the 5-mm overlay; this overlay is the sum of the 2-mm and 3-mm overlays.
- You may observe high sensitivity on BTN0 and BTN3 with the 2-mm overlay. This is because of the bigger button size.

Figure 3-1. External Capacitor Connected to J5

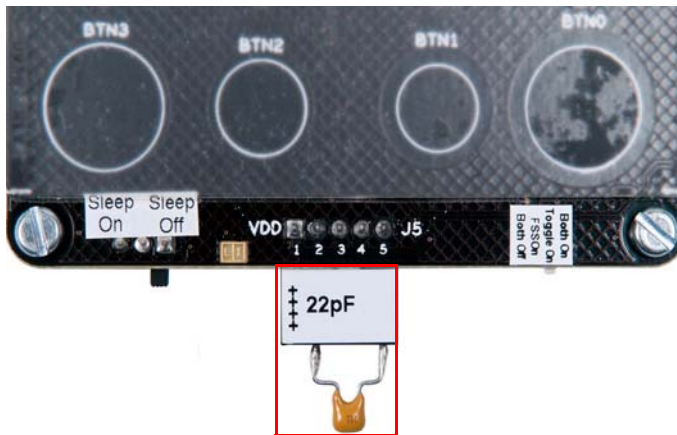

Connect capacitors of different values (22 pF and 10 pF). Ensure that power is toggled after placing a new capacitor. Button BTN2 continues to work. Now, connect the 68-pF capacitor; LED2 will blink at power up because of the [System Diagnostic Feature](#). When you touch the sensor, no LED turns on. This is because of SmartSense, which works up to 40 pF.

3.3 Toggle Feature

This section demonstrates the Toggle feature of the CY8CMBR2044 CapSense controller using the CY3280-MBR kit. This feature toggles the LED state (Off/On) at each touch on the corresponding button. Before proceeding, power the kit in default mode by following the steps in section [2.5 Power the Kit on page 11](#).

3.3.1 Test CapSense Buttons with Toggle Feature Disabled

Touch a CapSense button; the respective LED turns on. When you release the finger, the LED turns off. This is normal operation of the CapSense controller seen on all CapSense buttons.

Figure 3-2. Kit with Toggle Feature Disabled



1. Touch a button; the LED turns on

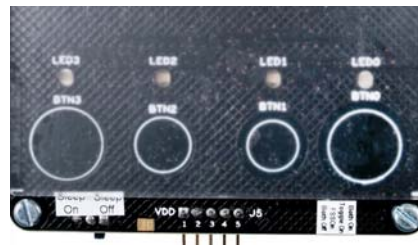

2. Release the button; the LED turns off

3.3.2 Enable Toggle Feature

Ensure the position of SW1 is changed to Toggle On to enable the Toggle feature; see [Figure 3-3](#). Touch the power button once to turn off the power; the power LED turns off. Press the power button again to turn on the power. This is because the CapSense controller should be reset every time the hardware strapping inputs change. The toggle feature is now enabled.

Figure 3-3. Switch Position for Toggle Feature



3.3.3 Test CapSense Buttons with Toggle Feature Enabled

Touch any CapSense button; the respective LED turns on. When the finger is released from the button, the LED remains in the ON state. If the same button is pressed again, the LED turns off and remains in the same state when the finger is released. At the next touch, the LED turns on and remains in the same state when the finger is released. This means, every time the button is pressed, the state of the button sensor output keeps toggling between the ON and OFF states. This behavior is seen on all CapSense buttons.

Figure 3-4. Toggle Feature Test Sequence

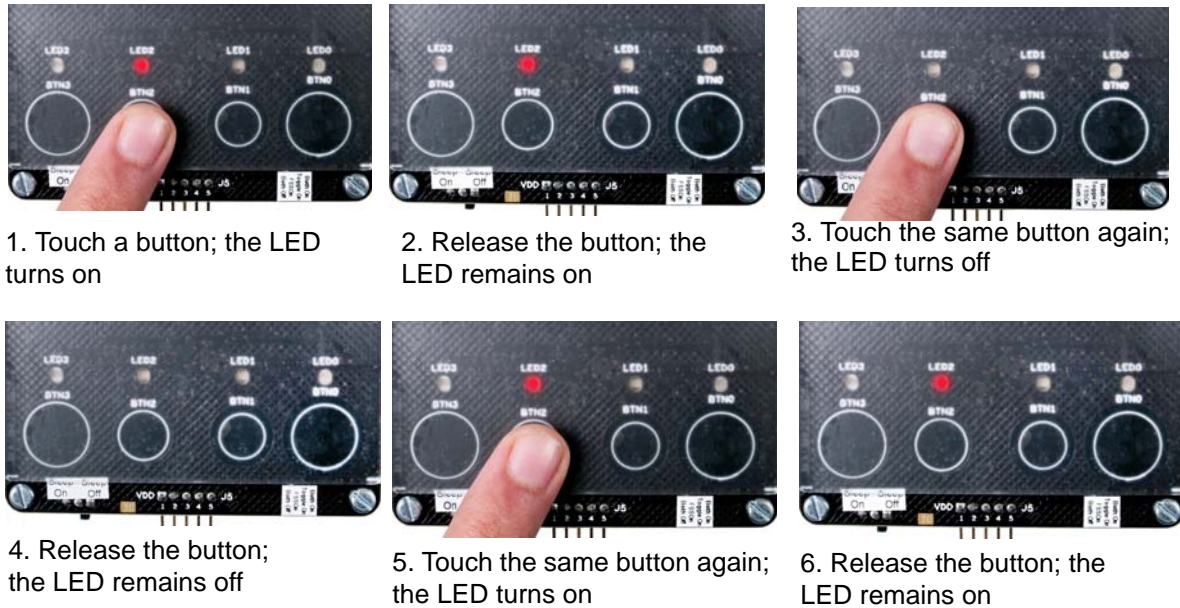

3.4 Flanking Sensor Suppression (FSS) Feature

The FSS feature allows only one button to be in the TOUCH state at a time. Enabling this feature will help distinguish TOUCH states for closely spaced buttons. If a finger contacts multiple buttons, only the first one to sense a TOUCH state turns on. This feature can also be used in situations when a button can produce opposite effects. For example, an interface with two buttons for brightness control (up or down). The FSS action can be explained for the following scenarios:

- When only one button is touched, it is reported as on.

Figure 3-5. FSS when One Button is Touched



- When more than one button is detected as on, and previously one of those buttons was touched, then the button touched previously is reported as on.

Figure 3-6. FSS when Multiple Buttons are Touched with One Button ON Previously



Before proceeding, power the kit in default mode by following the steps in section [2.5 Power the Kit](#) on page 11.

3.4.1 Test CapSense Buttons with FSS Feature Disabled

Touch more than one CapSense button simultaneously; the respective LEDs turn on. When each button is released, the respective LEDs turn off. This is normal operation of the CapSense controller, seen on all CapSense buttons.

Figure 3-7. Kit with FSS Feature Disabled



3.4.2 Enable FSS Feature

Ensure the SW1 switch is in FSS On to enable the FSS feature, see [Figure 3-8](#). Touch the power button once to turn off the power and ensure the power LED is turned off. Press the power button again to turn on the power. This is because the CapSense controller should be reset every time the hardware strapping inputs change. The FSS feature is now enabled.

Note The Toggle/FSS feature is enabled/disabled by the FSS/Toggle pin of the CY8CMBR2044 device. This pin uses different resistor values for different configuration settings. The following table maps the SW1 switch position to the resistor values used with the FSS/Toggle pin.

Table 3-1. Device Features vs. Resistor Configuration Matrix

Toggle	FSS	Toggle/FSS pin
Disabled	Disabled	Ground/Floating
Enabled	Disabled	1.5 k Ω (\pm 5%) to ground
Disabled	Enabled	5.1 k Ω (\pm 5%) to ground
Enabled	Enabled	VDD

See the [CY8CMBR2044 datasheet](#) for more details.

Figure 3-8. Switch Position for FSS Feature

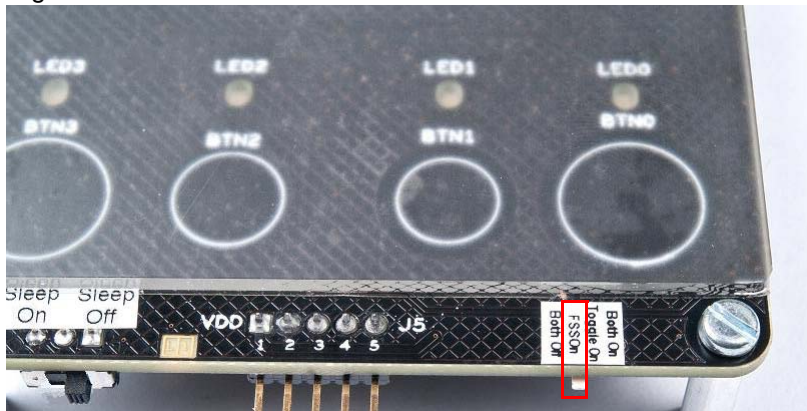

3.4.3 Test CapSense Buttons with FSS Feature Enabled

Touch more than one CapSense button; only one button turns on. Try with the other buttons and notice the same behavior. This feature help to distinguish closely spaced sensors and protect them

from false triggers. The priority of activation of buttons when more than one button is touched simultaneously while the FSS feature is enabled is as follows: BTN0>BTN1>BTN2>BTN3. See the [CY8CMBR2044 datasheet](#) for more information.

Figure 3-9. FSS Feature Test Sequence



1. Touch two buttons; the LED of the button pressed first turns on

2. Release the activated button, activated LED turns off and the other LED turns on

3. Without releasing the button, touch any button; no other LED turns on

3.5 Toggle and FSS Features Combined

This section demonstrates the FSS and Toggle features of the CY8CMBR2044 CapSense controller enabled together. Before proceeding, power the kit in default mode by following the steps in section [2.5 Power the Kit on page 11](#).

3.5.1 Test CapSense Buttons FSS and Toggle Features Disabled

Touch more than one CapSense button; the respective LEDs turn on. When each button is released, the respective LED turns off. You have seen this behavior in previous sections.

Figure 3-10. Kit with Toggle and FSS Features Disabled



1. Touch two buttons simultaneously, both LEDs turn on

2. Release both buttons, both LEDs turn off

3.5.2 Enable Both FSS and Toggle Features

Ensure the SW1 switch is set to Both On to enable FSS and Toggle features together, see [Figure 3-11](#). Touch the power button once to turn off the power; ensure the power LED is turned off. Press the power button again to turn on the power. This is because the CapSense controller should be reset every time the hardware strapping inputs change. The FSS and Toggle features are now enabled.

Figure 3-11. Switch Position for Toggle and FSS Features



3.5.3 Test CapSense Buttons with FSS and Toggle Features Enabled

Touch more than one CapSense button; only one LED turns on. When the same button is released, the LED remains on. Successive activation of the button sensor makes the respective output toggle between the ON and OFF states. At the same time, the CapSense controller stops activation of more than one button together.

Figure 3-12. Test Sequence



1. Touch two buttons (BTN1 first); only one LED turns on



2. Release both buttons (BTN2 first); the activated LED remains on



3. Touch the button of the activated LED; the LED turns off



4. Release the button; the LED remains off



5. Touch both buttons (BTN2 first); only one LED turns on



6. Release both buttons (BTN1 first); the activated LED remains on

3.6 LED On Time Feature

This section demonstrates the LED On Time feature of the CY8CMBR2044 CapSense controller using the CY3280-MBR kit. Before proceeding, power the kit in default mode by following the steps in section [2.5 Power the Kit on page 11](#).

3.6.1 Test CapSense Buttons with LED On Time Feature Disabled

Touch a CapSense button; the respective LED turns on. When the finger is released, the LED turns off immediately. This is normal operation of the CapSense controller, seen on all CapSense buttons.

Figure 3-13. Kit with LED On Time Feature Disabled

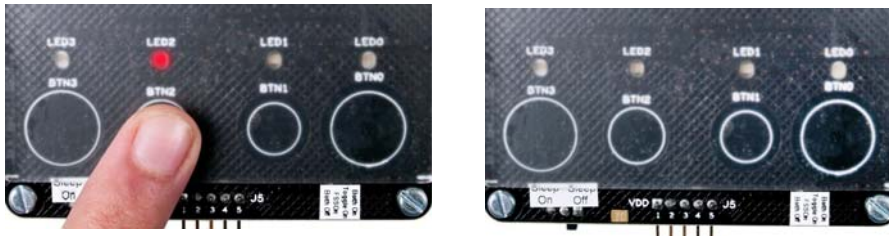

1. Touch a button: the LED turns on
2. Release button; the LED turns off immediately

3.6.2 Enable LED On Time Feature

The 'delay' pin is connected to a potentiometer and helps to change the resistor value to all supported values. This potentiometer is marked as DELAY on the kit. The kit should be held such that 'DELAY' text is readable. Turn the potentiometer to the extreme left.

Touch the power button once to turn off the power and ensure the power LED is turned off. Press the power button again to turn on the power. This is because the CapSense controller should be reset every time the hardware strapping inputs change. The LED On Time feature is now enabled.

Figure 3-14. Delay Potentiometer Turned Extreme Left

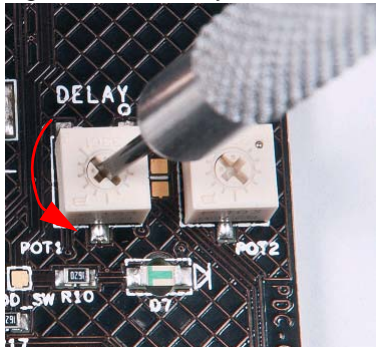

3.6.3 Test CapSense Buttons with LED On Time Feature Enabled

Touch any CapSense button; the respective LED turns on. When the finger is released, the LED turns off after some delay. Play with it; the delay depends on the value of the resistor connected to the 'delay' input. Keep the potentiometer at different positions to see different delays. Ensure power is toggled every time the position of the potentiometer changes. See the [CY8CMBR2044 datasheet](#) for more information on this feature.

Figure 3-15. Test Sequence for LED On Time Feature



1. Touch a button; the LED turns on
2. Release the button; the LED remains on
3. The LED turns off automatically without any action after 2 seconds

The delay in turning the LED off automatically after the release of the respective button can be controlled using the potentiometer. Note that turning the potentiometer halfway in the clockwise direction makes the LED turn off automatically within half the time of the first experiment. The LED on time is maximum (2 ms) when the potentiometer is turned completely to the left in an anti-clockwise direction. When the potentiometer is turned to the extreme right in the clockwise direction, this feature will be disabled.

Note The LED On Time feature is applicable to the last button released. To understand this, touch any button while this feature is enabled. Release the finger, the button remains on because of the LED On Time feature. Before the LED goes off, touch any other button. Release the second button immediately. The first LED goes off immediately after the release of the second button; the second LED demonstrates this feature. The LED On Time feature is disabled if the Toggle feature is enabled.

See the [CY8CMBR2044 datasheet](#) for more details.

3.7 Scan Rate/Sleep Feature

This section demonstrates the Sleep feature of the CY8CMBR2044 CapSense controller using the CY3280-MBR kit. Before proceeding, power the kit in default mode by following the steps in section [2.5 Power the Kit on page 11](#).

3.7.1 Test CapSense Buttons with Sleep Feature Disabled

Touch a CapSense button; the respective LED turns on. When the finger is released, the LED turns off immediately. This is normal operation of the CapSense controller, seen on all CapSense buttons.

Figure 3-16. Kit with Sleep Feature Disabled



1. Touch a button; the LED turns



2. Release the button; the LED turns off

3.7.2 Enable Sleep Feature

The Scan Rate/Sleep pin of the CapSense controller is connected to a potentiometer. This helps to change the value of the hardware strapping input connected to the pin. This potentiometer is marked as SLEEP on the kit. The kit should be held such that the 'SLEEP' text is readable. Ensure that the SW2 switch is configured as Sleep On. Turn the Sleep potentiometer to the left, but not extreme left.

Touch the power button once to turn off the power and ensure the LED is turned off. Press the power button again to turn on the power. This is because the CapSense controller should be reset every time the hardware strapping inputs change. The Sleep feature is now enabled.

Figure 3-17. Sleep Potentiometer Turned to Left

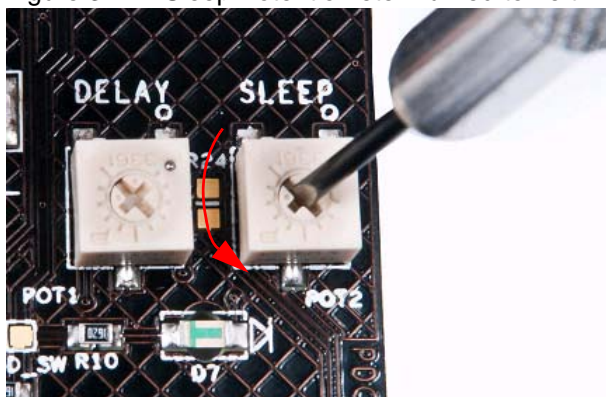

3.7.3 Test CapSense Buttons with Sleep Feature Enabled

Touch any CapSense button; the respective LED turns on. When the finger is released, the LED turns off. There is no visible difference, but the CY8CMBR2044 CapSense controller is now working at a lower average power. To test the average current consumed by the CapSense controller, desolder the R7 resistor and connect an ammeter in its place. Removing the R7 resistor allows to measure the current consumed by the CapSense controller without including the current consumed by other circuits such as LEDs. The ammeter shows the average power consumed by the CapSense controller. As the potentiometer is turned more towards the left, the average power continues to reduce. Typically, the measured current varies from 2.88 mA to 4 mA.

Figure 3-18. Setup to Measure Average Current

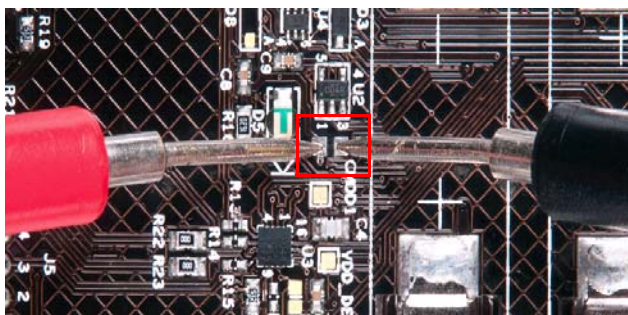

3.8 ARST Feature

This section demonstrates the auto-reset (ARST) feature of the CY8CMBR2044 CapSense controller using the CY3280-MBR kit. Before proceeding, power the kit in default mode by following the steps in section [2.5 Power the Kit on page 11](#).

3.8.1 Enable/Disable ARST Feature

The ARST feature is enabled in this kit by default. The 5.1-K resistor connected to the ARST port pin and ground configures the sensor auto-reset time to 20 seconds. To disable the ARST feature, connect ARST (pin 33 of J2) to VDD (pin 1 of J5). The VDD_ext (pin 41 of J2) cannot be used to disable this feature when the kit is powered through batteries. This pin is floating when the kit is battery powered.

Figure 3-19. Resistor Connected to ARST

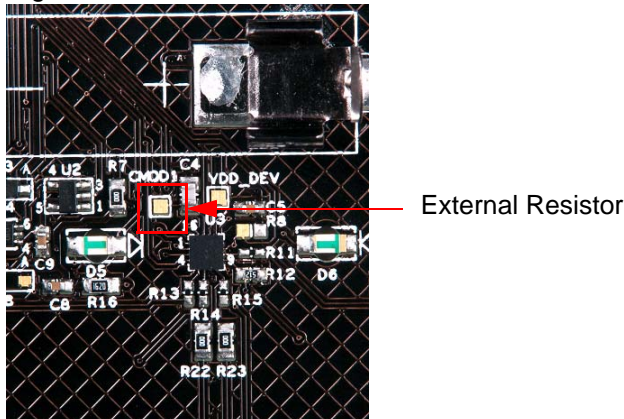

3.8.2 Test CapSense Buttons with ARST Feature Enabled

Touch any CapSense button; the respective LED turns on. Do not release the button; keep the finger pressed for more than 20 seconds. Observe that the LED turns off automatically after 20 seconds. Release the buttons and touch the same buttons again; it works as usual.

Figure 3-20. Test Sequence for ARST Feature



1. Touch a button; the LED turns on

2. Hold button in same state

3. After 20 seconds, the LED turns off automatically

The ARST signal is connected to pin 33 of the J2 connector. This helps to connect the ARST pin to ground and make the sensor auto-reset time as 5 seconds. When the ARST pin is grounded, auto-reset time is reduced to 5 seconds. See the [CY8CMBR2044 datasheet](#) for more information on this feature.

3.9 System Diagnostic Feature

This section demonstrates the System Diagnostics feature of the CY8CMBR2044 CapSense controller using the CY3280-MBR kit. Before proceeding, power the kit in default mode by following the steps in section [2.5 Power the Kit on page 11](#).

3.9.1 Enable System Diagnostics Feature

The System Diagnostics feature is enabled in the CY8CMBR2044 CapSense controller by default. No change is needed in the kit.

3.9.2 Test System Diagnostics Feature - CapSense Button Short to Ground

Follow these steps:

1. Press the power button to turn off the kit.
2. Connect a wire between pin 2 and pin 4 of connector J5. This shorts the BTN1 sensor to ground.

3. Press the power button to turn on the kit.

The System Diagnostics routine is executed by the CapSense controller on power up and the sensor shorted to ground is detected. On power up, observe a pulse of 5-ms width on LED1 pin, which indicates that BTN1 is shorted to ground. CapSense controller disables the button sensors that are shorted to ground. Touch **BTN1** and see that LED1 is not turned on. Other buttons work normally.

Figure 3-21. BTN1 Sensor Shorted to Ground

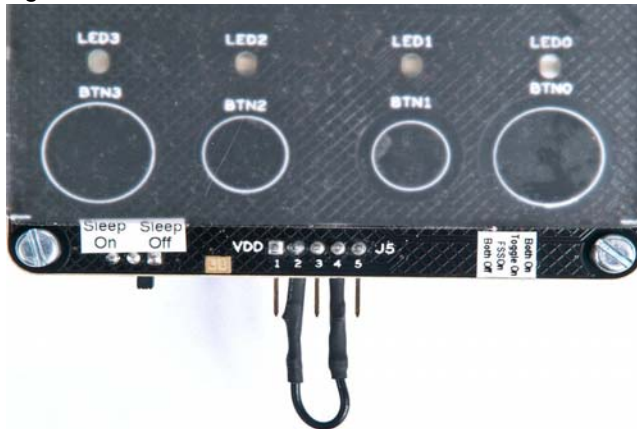

3.9.3 Test System Diagnostics Feature - CapSense Button to Button Short

Follow these steps:

1. Press the power button to turn off the kit.
2. Connect a wire between pin 4 and pin 5 of connector J5. This shorts BTN1 and BTN2 sensors.
3. Press the power button to turn on the kit.

The System Diagnostics routine is executed by the CapSense controller on power up and the sensor to sensor short is detected. On power up, observe a pulse of 5-ms width on LED1 and LED2 pins, which indicates that BTN1 is shorted to BTN2. The CapSense controller disables the button sensors that are shorted to each other. Touch **BTN1** or **BTN2**; note that the respective LEDs are not turned on. Other buttons work normally.

Figure 3-22. BTN1 Sensor Shorted to Ground



A.2 Board Layouts

A.2.1 PDC-09587 Top

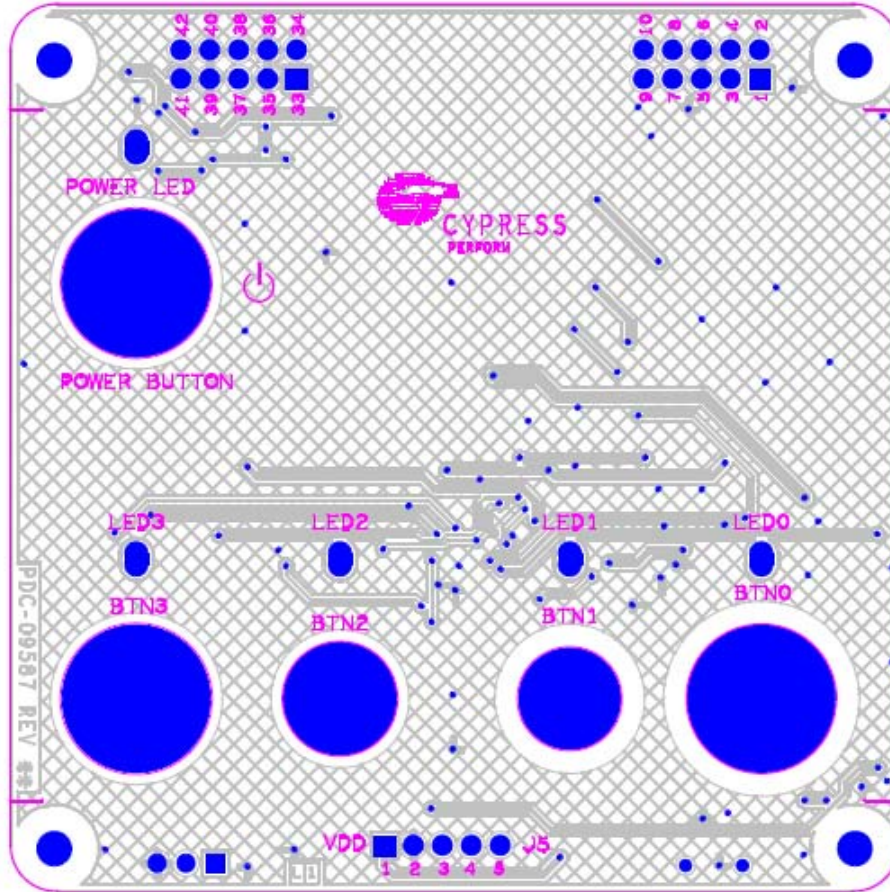

A.3 Bill of Materials

Item	Qty.	Reference	Value	Description	Manufacturer	Manufacturer Part No.
1				PCB	Cypress	PDC-09587 Rev04
2	2	C1,C4	2200 pFd	CAP CER 2200PF 50V 5% C0G 0805	Murata Electronics	GRM2165C1H222JA01D
3	4	C2,C5,C8,C9	0.1 uFd	CAP .10UF 10V CERAMIC X7R 0603	Kemet	C0603C104K8RACTU
4	3	C3,C6,C7	10 uFd 16v	CAP CERAMIC 10.0UF 16V X5R 1206	Kemet	C1206C106K4PACTU
5	5	D1,D4,D5,D6,D7	LED Red	LED Red CLEAR 1206 REAR MNT SMD	Stanley Electric Co	BR1111R-TR
6	2	D2,D3	DIODE SCHOTTKY	DIODE SCHOTTKY 0.5A 20V SOD-123	Fairchild Semiconductor	MBR0520L
7	2	J1,J2	CONN HEADER 10POS .100 R/A 15AU	CONN HEADER 10POS .100 R/A 15AU	FCI	68021-210HLF
8	4	J3,J4	Battery Clip AAA	CLIP BATTERY AAA/N .375X.460" SS	Keystone Electronics	55TR
9	1	J5	5 HEADER	CONN MALE 5POS .100" R/A GOLD	3M	961105-5604-AR
10	2	POT1,POT2	10k	TRIMPOT 10K OHM 6MM SQ SMD	Bourns Inc.	3361P-1-103GLF
11	5	R1,R2,R3,R12,R19	5.1K	RES 5.1K OHM 1/16W 1% 0603 SMD	Yageo Corporation	RC0603FR-075K1L
12	1	R20	1.5K	RES 1.50K OHM 1/16W 1% 0603 SMD	Yageo Corporation	RC0603FR-071K5L
14	5	R4,R11,R13,R14,R15	560E	RES 560 OHM 1/16W 5% 0402 SMD	Yageo Corporation	RC0402JR-07560RL
15	5	R5,R9,R10,R16,R17	330 ohm	RES 330 OHM 1/8W 1% 0805 SMD	Panasonic-ECG	ERJ-6ENF3300V
16	5	R6,R7,R18,R22,R23	ZERO	RES 0.0 OHM 1/10W 5% 0805 SMD	Panasonic-ECG	ERJ-6GEY0R00V
17	1	SW1	SP4T	SWITCH SLIDE SP4T LOW PROF SMD	Copal Electronics Inc	CUS-14TB
18	1	SW2	SPDT	SWITCH SLIDE SPDT .3A RT ANGLE	E-Switches	EG1270
19	2	U1,U3	CY8CMBR2044	CY8CMBR2044	Cypress	CY8CMBR2044
20	1	U4	MIC94090 SC-70-6	IC LOAD SW HGH SIDE 1.2A SC70-6	Micrel Inc	MIC94090YC6 TR
21	1	U2	SN74LVC1GU04	IC SINGLE INVERTER GATE SOT-23-5	Texas Instruments	SN74LVC1GU04DBVR
22	1	R21	ERJ-6GEYJ220V	RES 22 OHM 1/8W 5% 0805 SMD	Panasonic-ECG	ERJ-6GEYJ220V
No Load Components						
23	1	B0	CapSense Button 13mm Round			
24	1	B1	CapSense Button 9mm Round			
25	1	B2	CapSense Button 10mm Round			
26	2	B3,B4	CapSense Button 13mm Round			
27	6	CMOD1,CMOD2,VIN,VDD_Dev,VDD_Bat,VDD	T POINT R			
28	1	R24	ZERO	RES 0.0 OHM 1/10W 5% 0805 SMD	Panasonic-ECG	ERJ-6GEY0R00V
29	1	R8	NO LOAD			
30	1	D8	DIODE SCHOTTKY	DIODE SCHOTTKY 0.5A 20V SOD-123	Fairchild Semiconductor	MBR0520L

A.4 Frequently Asked Questions

This section provides solutions for problems that you may encounter when working with the CY3280-MBR kit.

Q. Power LED does not turn on when the power button is pressed

A. This can happen for the following reasons:

- The kit is not powered by any of the power sources. Ensure that there is a power supply.
- The battery connected to the kit does not have charge. Replace old batteries with a new AAA battery set or try powering the kit from an external power source.
- Battery is inserted in reverse. The polarity of the battery should match the polarity mark given on the kit. Follow the steps in section [2.5 Power the Kit on page 11](#) to insert the batteries correctly into the battery holder.

Q. BTN1 and BTN2 does not work with 5-mm overlays

A. For a button sensor to work with an overlay of a specific thickness, the button should have the required diameter. The diameter of BTN1 and BTN2 is not enough to support the 5-mm overlay. This also means that to support a particular overlay thickness, the correct value of the button diameter should be selected in your design. To find the required button diameter for a particular overlay thickness, refer to the [CY8CMBR2044 datasheet](#), application note [AN59004 - Four Button CapSense Design using CY8CMBR2044](#), and the [Design Guide Tool](#).

Q. Some buttons are too sensitive with a 2-mm overlay

A. For a button to successfully work at correct sensitivity with a given overlay, choose the button size according to the design box. If the design box recommendation is not followed, buttons of bigger size may be oversensitive with thinner overlays.

Q. Touching on the bottom layer of the PCB creates false button triggers

A. Traces connecting the CapSense sensor and CapSense controller are routed on the bottom layer of the PCB. When you touch these traces, the sensors can create a false trigger. This is because the traces are touched without any overlay, making them very sensitive. However, in the actual product, the PCB and traces are not accessible to the user and hence this is not a problem.

Q. When external capacitors are added to the J5 connector to increase the parasitic capacitance of BTN2, the sensors produces false trigger

A. The BTN1 and BTN2 sensors are connected to the J5 connector. When connecting the capacitor to the sensor, sensor capacitance is increased. This is similar to the capacitance increase due to finger touch. Therefore, the CapSense controller misinterprets it as finger touch. When external capacitors are connected, toggle power to offset the capacitance increase.

Q. After changing the switch positions, there is no change in kit operation

A. Hardware strapping inputs are read by the CapSense controller only during boot up. When a hardware strapping input status is changed, reset the CapSense controller using the XRES pin or toggle power for the change to take effect.

Q. Additional overlay sometimes creates false triggers

A. When an overlay is placed on the top of the button, capacitance may be increased and this is interpreted as finger signal. Every time the overlay is changed, reset the CapSense controller using the XRES pin or toggle power.

Q. Touching the J5 connector creates false triggers on BTN1 and BTN2

A. BTN1 and BTN2 are connected to pin 4 and pin 5 of the J5 connector to evaluate SmartSense. Touching the J5 connector increases the capacitance of BTN1 and BTN2, and is misinterpreted as a button touch. In the actual product, the sensor signals are not exposed.

