

Phase leg
Series & SiC parallel diodes
MOSFET Power Module

$V_{DSS} = 1000V$

$R_{DSon} = 230m\Omega$ typ @ $T_j = 25^\circ C$

$I_D = 36A$ @ $T_c = 25^\circ C$

Application

- Motor control
- Switched Mode Power Supplies
- Uninterruptible Power Supplies

Features

- **Power MOS 7[®] MOSFETs**
 - Low R_{DSon}
 - Low input and Miller capacitance
 - Low gate charge
 - Avalanche energy rated
- **Parallel SiC Schottky Diode**
 - Zero reverse recovery
 - Zero forward recovery
 - Temperature Independent switching behavior
 - Positive temperature coefficient on VF
- Kelvin source for easy drive
- Very low stray inductance
 - Symmetrical design
 - Lead frames for power connections
- Internal thermistor for temperature monitoring
- High level of integration

Benefits

- Outstanding performance at high frequency operation
- Direct mounting to heatsink (isolated package)
- Low junction to case thermal resistance
- Solderable terminals both for power and signal for easy PCB mounting
- Low profile
- RoHS Compliant

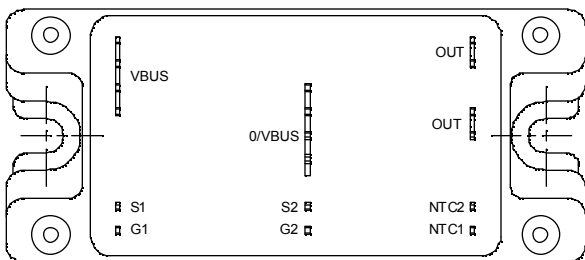
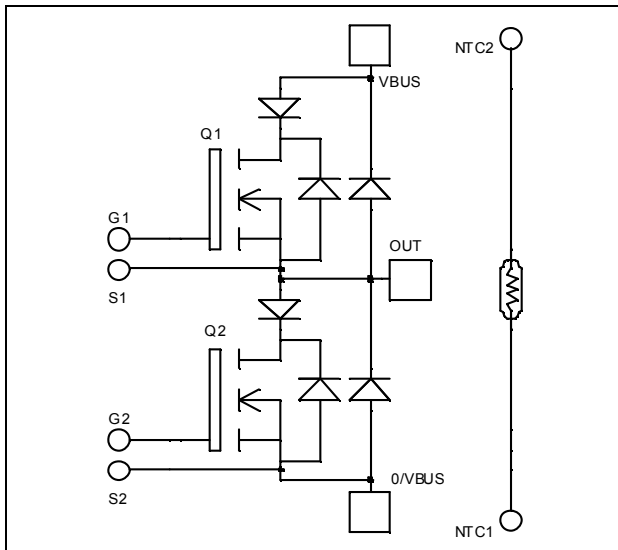

Absolute maximum ratings

Symbol	Parameter	Max ratings	Unit
V_{DSS}	Drain - Source Breakdown Voltage	1000	V
I_D	Continuous Drain Current	$T_c = 25^\circ C$	36
		$T_c = 80^\circ C$	27
I_{DM}	Pulsed Drain current	144	A
V_{GS}	Gate - Source Voltage	± 30	V
R_{DSon}	Drain - Source ON Resistance	270	m Ω
P_D	Maximum Power Dissipation	$T_c = 25^\circ C$	694
I_{AR}	Avalanche current (repetitive and non repetitive)	18	A
E_{AR}	Repetitive Avalanche Energy	50	mJ
E_{AS}	Single Pulse Avalanche Energy	2500	

CAUTION: These Devices are sensitive to Electrostatic Discharge. Proper Handling Procedures Should Be Followed. See application note APT0502 on www.microsemi.com

All ratings @ $T_j = 25^\circ\text{C}$ unless otherwise specified

Electrical Characteristics

Symbol	Characteristic	Test Conditions	Min	Typ	Max	Unit
I_{DSS}	Zero Gate Voltage Drain Current	$V_{GS} = 0V, V_{DS} = 1000V$			200	μA
		$V_{GS} = 0V, V_{DS} = 800V$			1000	
$R_{DS(on)}$	Drain – Source on Resistance	$V_{GS} = 10V, I_D = 18A$		230	270	$\text{m}\Omega$
$V_{GS(th)}$	Gate Threshold Voltage	$V_{GS} = V_{DS}, I_D = 5\text{mA}$	3		5	V
I_{GSS}	Gate – Source Leakage Current	$V_{GS} = \pm 30V, V_{DS} = 0V$			± 150	nA

Dynamic Characteristics

Symbol	Characteristic	Test Conditions	Min	Typ	Max	Unit
C_{iss}	Input Capacitance	$V_{GS} = 0V$		8700		pF
C_{oss}	Output Capacitance	$V_{DS} = 25V$		1430		
C_{rss}	Reverse Transfer Capacitance	$f = 1\text{MHz}$		240		
Q_g	Total gate Charge	$V_{GS} = 10V$		308		nC
Q_{gs}	Gate – Source Charge	$V_{Bus} = 500V$		52		
Q_{gd}	Gate – Drain Charge	$I_D = 36A$		194		
$T_{d(on)}$	Turn-on Delay Time	Inductive switching @ 125°C $V_{GS} = 15V$ $V_{Bus} = 667V$ $I_D = 36A$ $R_G = 2.5\Omega$		10		ns
T_r	Rise Time			12		
$T_{d(off)}$	Turn-off Delay Time			121		
T_f	Fall Time			35		
E_{on}	Turn-on Switching Energy	Inductive switching @ 25°C $V_{GS} = 15V, V_{Bus} = 667V$ $I_D = 36A, R_G = 2.5\Omega$		767		μJ
E_{off}	Turn-off Switching Energy			760		
E_{on}	Turn-on Switching Energy	Inductive switching @ 125°C $V_{GS} = 15V, V_{Bus} = 667V$ $I_D = 36A, R_G = 2.5\Omega$		1255		μJ
E_{off}	Turn-off Switching Energy			902		

Series diode ratings and characteristics

Symbol	Characteristic	Test Conditions	Min	Typ	Max	Unit
V_{RRM}	Maximum Peak Repetitive Reverse Voltage		200			V
I_{RM}	Maximum Reverse Leakage Current	$V_R = 200V$	$T_j = 25^\circ\text{C}$		350	μA
			$T_j = 125^\circ\text{C}$		600	
I_F	DC Forward Current			60		A
V_F	Diode Forward Voltage	$I_F = 60A$		1.1	1.15	V
		$I_F = 120A$		1.4		
		$I_F = 60A$	$T_j = 125^\circ\text{C}$	0.9		
t_{rr}	Reverse Recovery Time	$I_F = 60A$ $V_R = 133V$ $di/dt = 400A/\mu\text{s}$	$T_j = 25^\circ\text{C}$	24		ns
			$T_j = 125^\circ\text{C}$	48		
Q_{rr}	Reverse Recovery Charge	$I_F = 60A$ $V_R = 133V$ $di/dt = 400A/\mu\text{s}$	$T_j = 25^\circ\text{C}$	66		nC
			$T_j = 125^\circ\text{C}$	300		

Parallel SiC diode ratings and characteristics

Symbol	Characteristic	Test Conditions	Min	Typ	Max	Unit
V _{RRM}	Maximum Peak Repetitive Reverse Voltage		1200			V
I _{RM}	Maximum Reverse Leakage Current	V _R =1200V		200 400	800 4000	μA
I _F	DC Forward Current			20		A
V _F	Diode Forward Voltage	I _F = 20A		1.6 2.6	1.8 3.0	V
Q _C	Total Capacitive Charge	I _F = 20A, V _R = 600V di/dt = 1200A/μs		56		nC
Q	Total Capacitance	f = 1MHz, V _R = 200V f = 1MHz, V _R = 400V		180 132		pF

Thermal and package characteristics

Symbol	Characteristic	Min	Typ	Max	Unit	
R _{thJC}	Junction to Case Thermal Resistance	Transistor		0.18	°C/W	
		Series diode		0.65		
		Parallel diode		0.8		
V _{ISOL}	RMS Isolation Voltage, any terminal to case t = 1 min, I _{isol} < 1mA, 50/60Hz	2500			V	
T _J	Operating junction temperature range	-40		150	°C	
T _{STG}	Storage Temperature Range	-40		125		
T _C	Operating Case Temperature	-40		100		
Torque	Mounting torque	To Heatsink	M5	2.5	4.7	N.m
Wt	Package Weight				160	g

Temperature sensor NTC (see application note APT0406 on www.microsemi.com for more information).

Symbol	Characteristic	Min	Typ	Max	Unit
R ₂₅	Resistance @ 25°C		50		kΩ
B _{25/85}	T ₂₅ = 298.15 K		3952		K

$$R_T = \frac{R_{25}}{\exp \left[B_{25/85} \left(\frac{1}{T_{25}} - \frac{1}{T} \right) \right]}$$

T: Thermistor temperature
R_T: Thermistor value at T

SP4 Package outline (dimensions in mm)

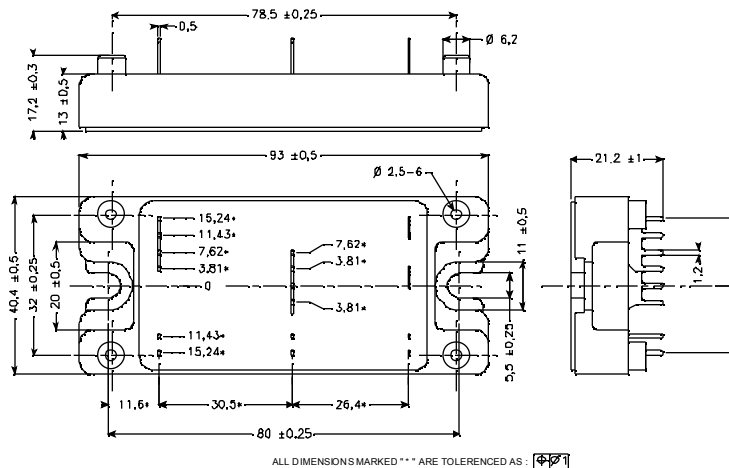

See application note APT0501 - Mounting Instructions for SP4 Power Modules on www.microsemi.com

Typical MOSFET Performance Curve

Maximum Effective Transient Thermal Impedance, Junction to Case vs Pulse Duration

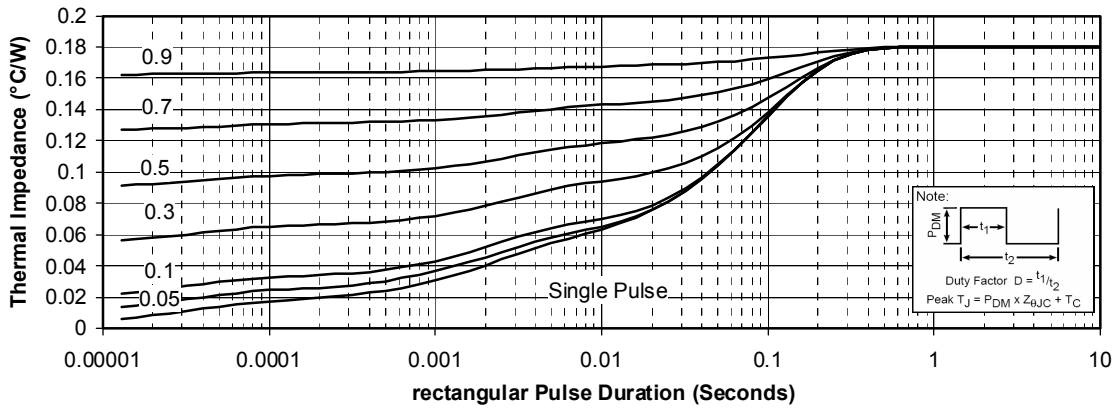

Low Voltage Output Characteristics

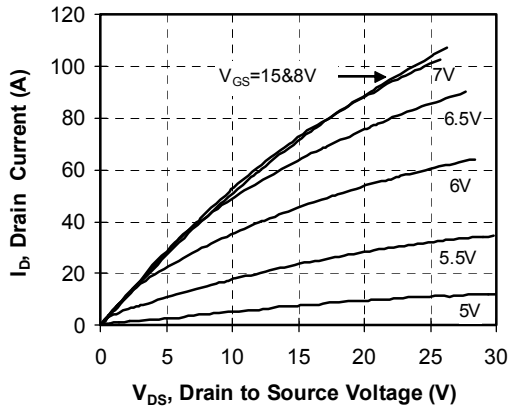

Transfer Characteristics

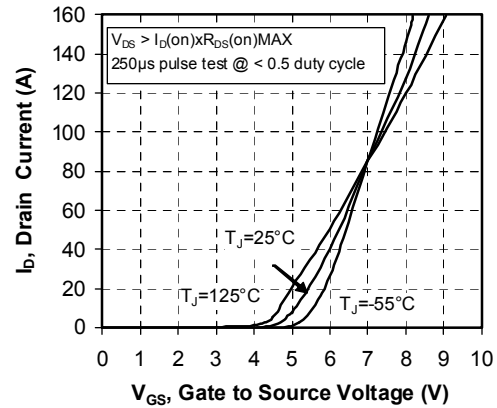

$R_{DS(\text{on})}$ vs Drain Current

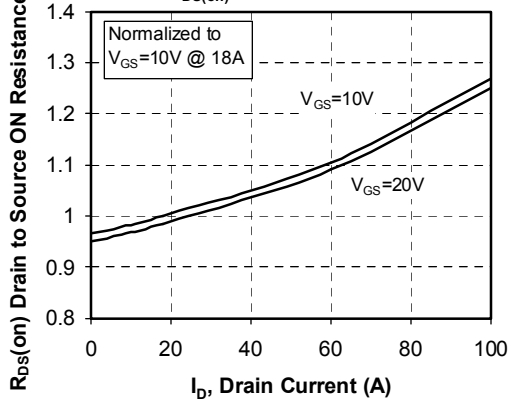

DC Drain Current vs Case Temperature

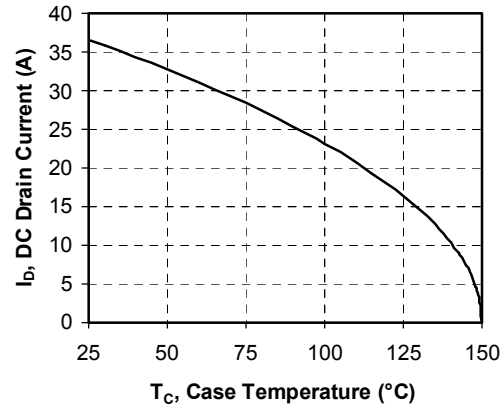

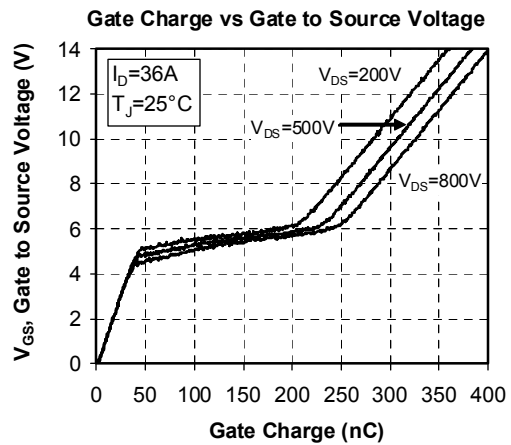
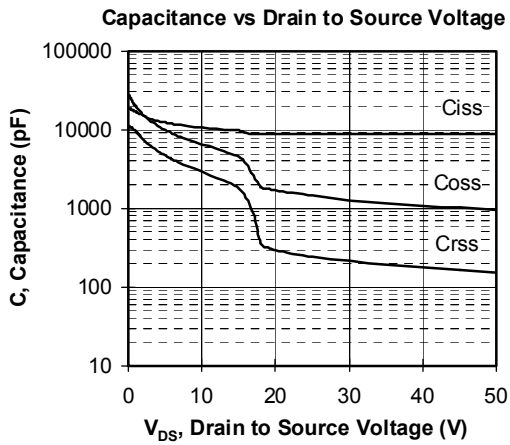
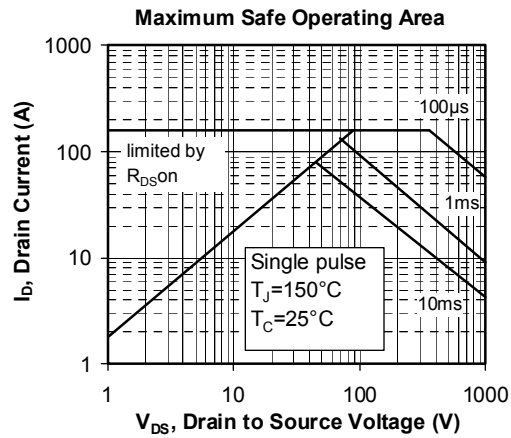
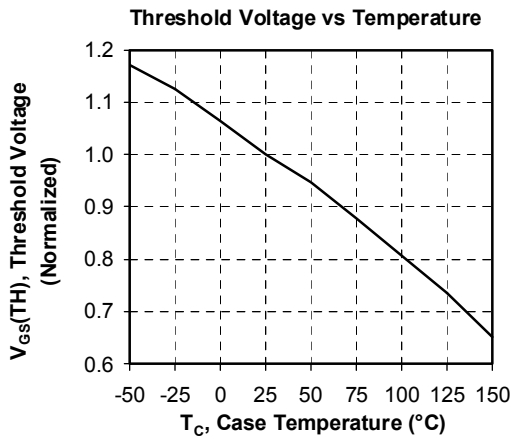
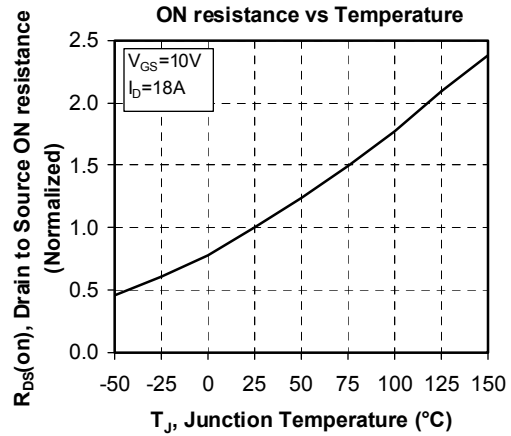
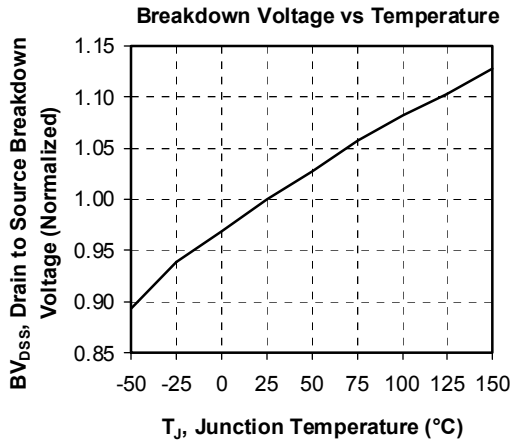

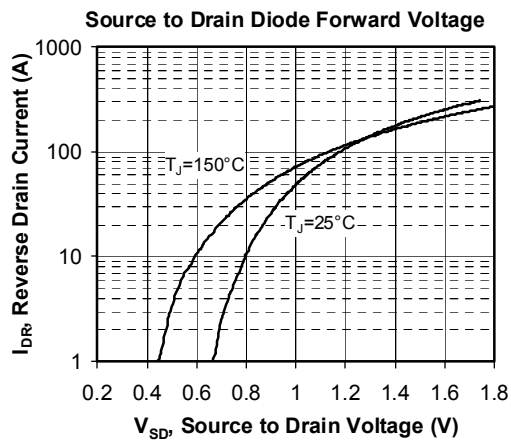
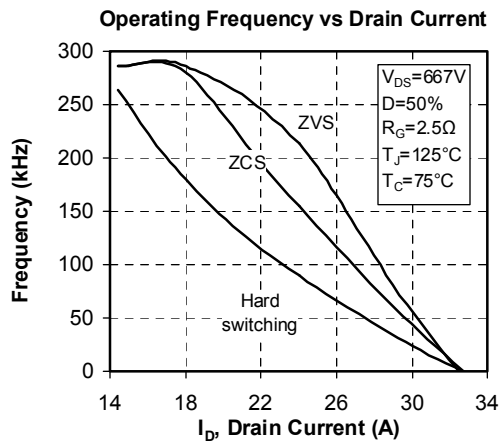
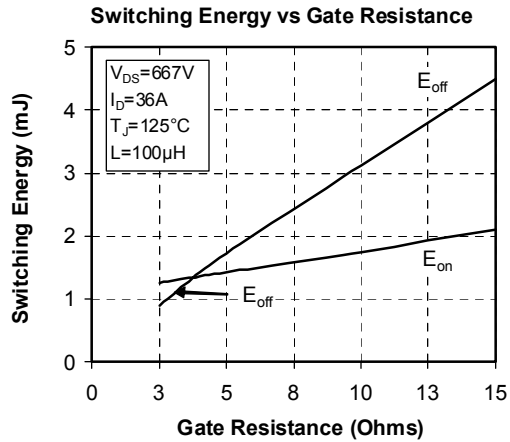
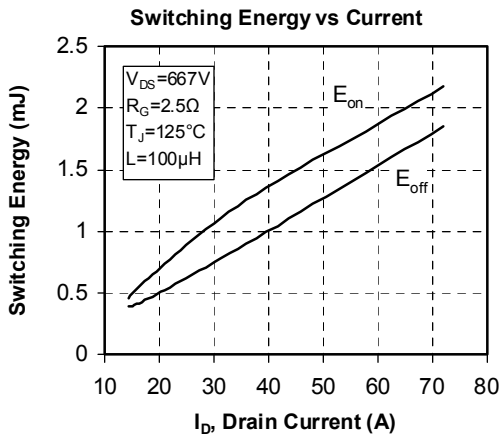
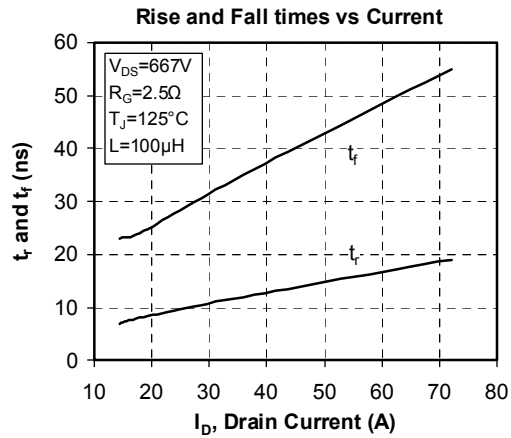
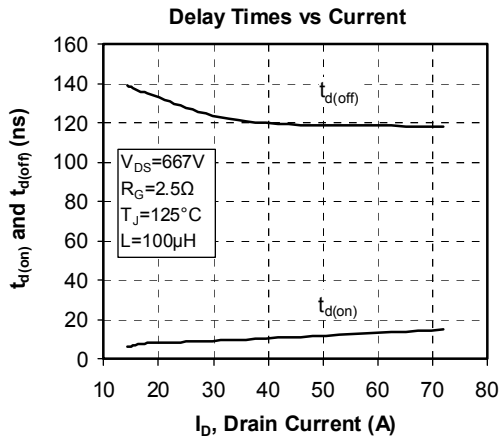

Typical SiC Diode Performance Curve

Maximum Effective Transient Thermal Impedance, Junction to Case vs Pulse Duration

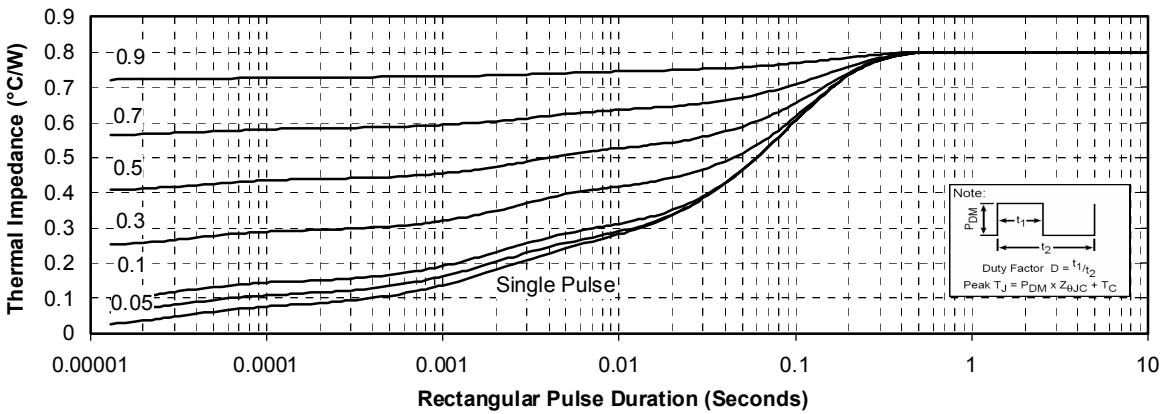

Forward Characteristics

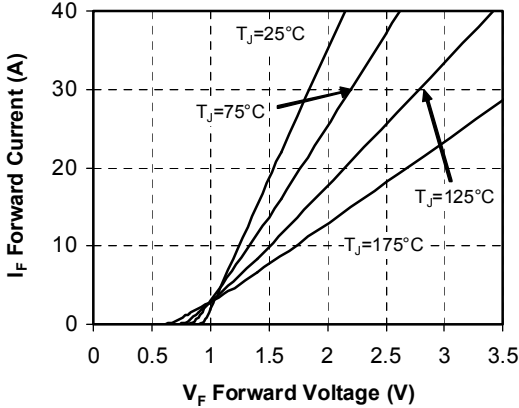

Reverse Characteristics

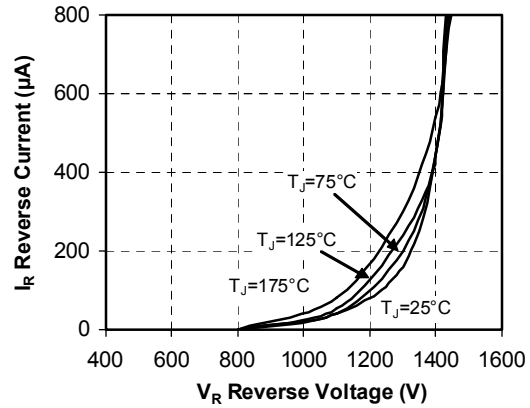

Capacitance vs. Reverse Voltage

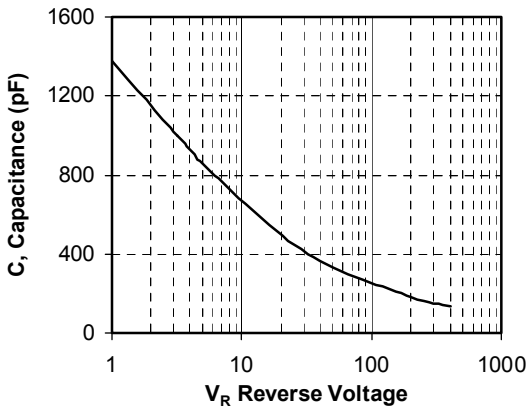

Microsemi reserves the right to change, without notice, the specifications and information contained herein

Microsemi's products are covered by one or more of U.S. patents 4,895,810 5,045,903 5,089,434 5,182,234 5,019,522 5,262,336 6,503,786 5,256,583 4,748,103 5,283,202 5,231,474 5,434,095 5,528,058 and foreign patents. U.S. and Foreign patents pending. All Rights Reserved.