

mm inch

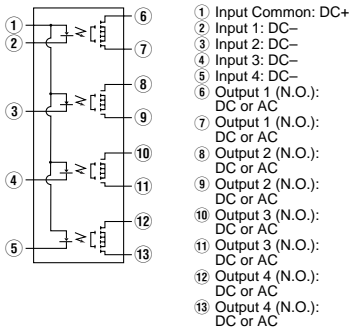

FEATURES

- 4-circuit (4-Form A) of GU PhotoMOS Relay** in a compact and slim 13 pin SIL
- Applicable for 4 Form A use, as well as 4 independent 1 Form A**
- Controls low-level analog signals**
PhotoMOS relays feature extremely low closed-circuit offset voltage to enable control of low-level analog signals without distortion.
- Low-level off state leakage current (Typical 100 pA at 100 V load voltage)**
- Optical coupling for extremely high isolation**
- Eliminates the need for a counter electromotive protection diode in the drive circuit on the input side**

- PC board layout is simplified**
- Eliminates the need for a separate power supply to drive the power MOS-FET**
- Low thermal electromotive force (Approx. 1 μ V)**
- No restriction on mounting direction**
- No arc, no bounce, no noise**

TYPICAL APPLICATIONS

- Telecommunication equipment
- High speed inspection machine, Scanner, IC checker
- Robots

TYPES

	Output rating*		Part No.	Packing quantity	
	Load voltage	Load current		Inner case	Outer carton
AC/DC type	400 V	80 mA	AQX21444	20 pcs.	200 pcs.

*Indicate the peak AC and DC values.

RATINGS

1. AC/DC type

1. Absolute maximum ratings (Ambient temperature: 25°C 77°F)

	Item	Symbol	AQX21444	Remarks
Input	LED forward current	I_F	50 mA	
	LED reverse voltage	V_R	3 V	
	Peak forward current	I_{FP}	1 A	$f = 100$ Hz, Duty factor = 0.1%
	Power dissipation	P_{in}	75 mW	
Output	Load voltage (peak AC)	V_L	400 V	
	Continuous load current	I_L	80 mA (100 mA)	(): in case of using only 1 channel Peak AC, DC
	Peak load current	I_{peak}	0.3 A	100 ms (1 shot), $V_L = DC$
	Power dissipation	P_{out}	1,450 mW	
Total power dissipation		P_T	1,500 mW	
I/O isolation voltage		V_{iso}	1,500 V AC	
Temperature limits	Operating	T_{opr}	-40°C to +85°C -40°F to +185°F	Non-condensing at low temperatures
	Storage	T_{stg}	-40°C to +100°C -40°F to +212°F	

2. Electrical characteristics (Ambient temperature: 25°C 77°F)

Item		Symbol	AQX21444	Condition	
Input	LED operate current	Typical	1.1 mA	I _L = 80 mA	
		Maximum	3 mA		
	LED turn off current	Minimum	0.4 mA	I _L = 80 mA	
		Typical	1.0 mA		
LED dropout voltage	Typical	1.14 V (1.25 V at I _F = 50 mA)		I _F = 5 mA	
	Maximum	1.5 V			
Output	On resistance	Typical	30 Ω	I _F = 5 mA I _L = 80 mA Within 1 s on time	
		Maximum	50 Ω		
	Off state leakage current	Maximum	I _{Leak}		1 μA
Transfer characteristics	Switching speed	Turn on time*	Typical	0.52 ms	I _F = 5 mA
			Maximum	2 ms	I _L = 80 mA
		Turn off time*	Typical	0.29 ms	I _F = 10 mA
			Maximum	1 ms	I _L = 80 mA
	I/O capacitance	Typical	C _{iso}	4.0 pF	f = 1 MHz
		Maximum		8.0 pF	V _B = 0
	Initial I/O isolation resistance	Minimum	R _{iso}	1,000 MΩ	500 V DC
	Vibration resistance		Minimum	—	10 to 55 Hz at double amplitude of 3 mm
Shock resistance		Minimum	—	4,900 m/s ² {500 G} 1 ms	3 times for 3 axes

Note: Recommendable LED forward current I_F = 5 mA.

For type of connection, see page 34.

*Turn on/Turn off time

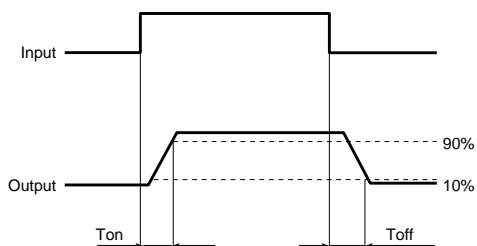

REFERENCE DATA

1. Load current vs. ambient temperature characteristics

Allowable ambient temperature: -40°C to +85°C
-40°F to +185°F

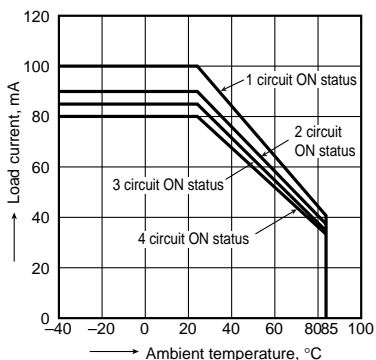

2. Load current in adjacent mounting vs. ambient temperature

Condition: 4 circuits ON status

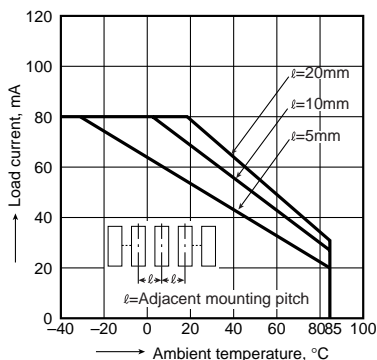

3. On resistance vs. ambient temperature characteristics

Measured portion: between terminals 6 and 7, 8 and 9, 10 and 11, 12 and 13; LED current: 5 mA; Continuous load current: 80 mA (DC)

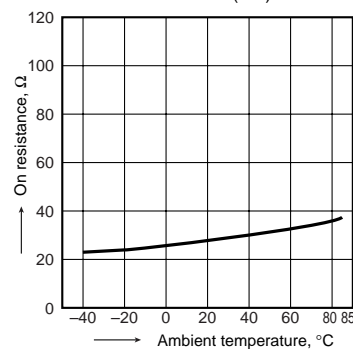

AQX21444

4. Turn on time vs. ambient temperature characteristics

Load voltage: 400 V (DC);
Continuous load current: 80 mA (DC)

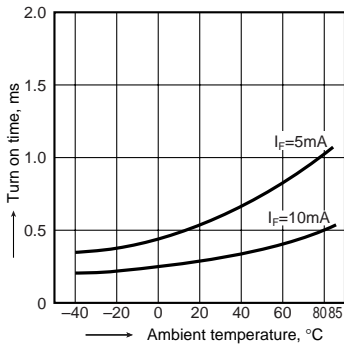

5. Turn off time vs. ambient temperature characteristics

Load voltage: 400 V (DC);
Continuous load current: 80 mA (DC)

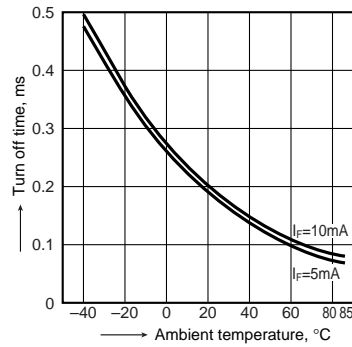

6. LED operate current vs. ambient temperature characteristics

Load voltage: 400 V (DC);
Continuous load current: 80 mA (DC)

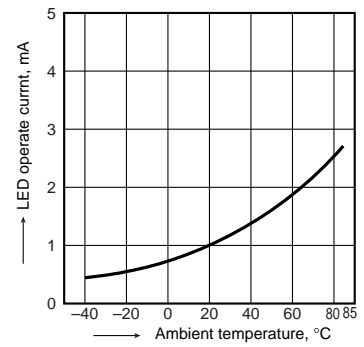

7. LED turn off current vs. ambient temperature characteristics

Load voltage: 400 V (DC);
Continuous load current: 80 mA (DC)

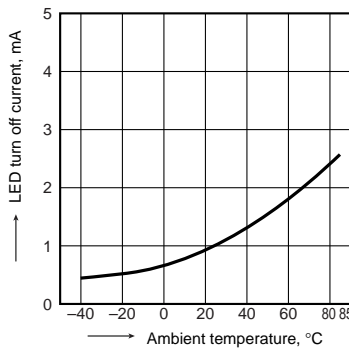

8. LED dropout voltage vs. ambient temperature characteristics

LED current: 5 to 50 mA

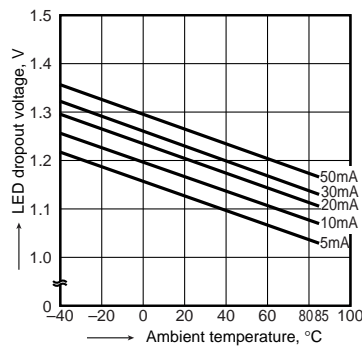

9. Voltage vs. current characteristics of output at MOS portion

Measured portion: between 6 and 7, 8 and 9, 10 and 11, 12 and 13; Ambient temperature: 25°C 77°F

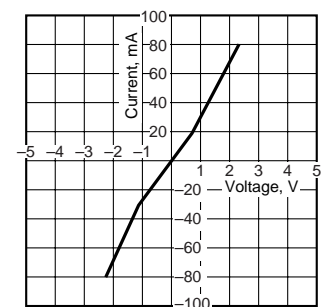

10. Off state leakage current

Measured portion: between terminals 6 and 7, 8 and 9, 10 and 11, 12 and 13;
Ambient temperature: 25°C 77°F

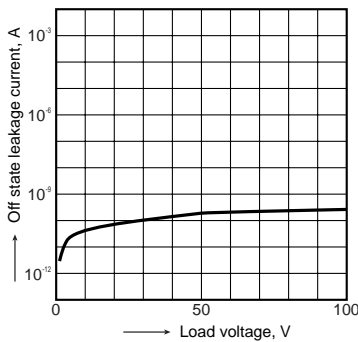

11. LED forward current vs. turn on time characteristics

Measured portion: between terminals 6 and 7, 8 and 9, 10 and 11, 12 and 13; Load voltage: 400 V (DC);
Continuous load current: 80 mA (DC);
Ambient temperature: 25°C 77°F

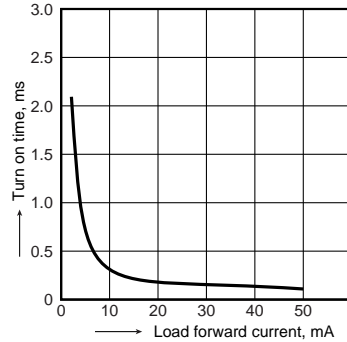

12. LED forward current vs. turn off time characteristics

Measured portion: between terminals 6 and 7, 8 and 9, 10 and 11, 12 and 13; Load voltage: 400 V (DC);
Continuous load current: 80 mA (DC);
Ambient temperature: 25°C 77°F

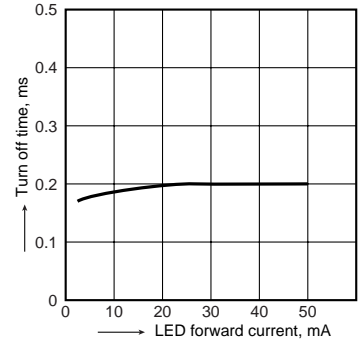

13. Applied voltage vs. output capacitance characteristics (AC/DC type)

Measured portion: between terminals 6 and 7, 8 and 9, 10 and 11, 12 and 13; Load voltage: 400 V (DC);
Frequency: 1 MHz; Ambient temperature: 25°C 77°F

