

REVISIONS					
REV	ECO	DESCRIPTION	DATE	BY	APPR
A1	-	RELEASE	5JUL17	JAH	

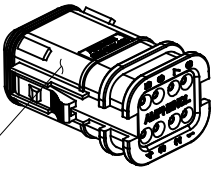

REFER TO PART NUMBER CHART FOR AVAILABLE CONNECTOR COLORS

REQUIRES CONTACT RETENTION WEDGE AW8S

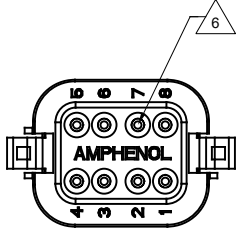
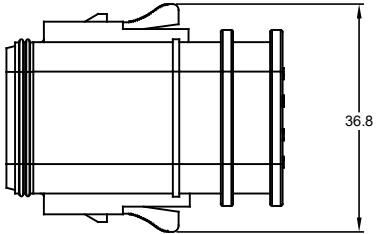
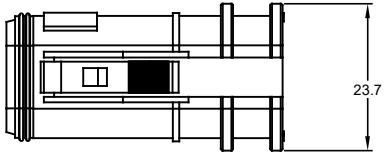
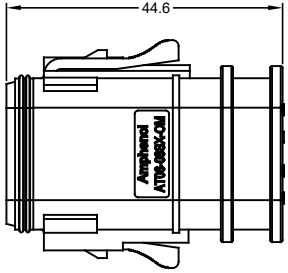
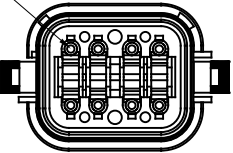

NOTES: UNLESS OTHERWISE SPECIFIED

- MATERIAL:
HOUSING: PA66 GF15
SEE SHEET 2 FOR KEY ARRANGEMENTS AND COLORS
SEALS: SILICONE RUBBER
- MODIFICATIONS: FOR OVER MOLDING
- SPECIFICATIONS:
 - CURRENT RATING: 13 AMPS
 - OPERATING TEMPERATURE: -55°C TO +125°C
 - DIELECTRIC WITHSTANDING VOLTAGE: LESS THAN 2 MILLIAMPS CURRENT LEAKAGE @ 1500 VOLTS AC.
 - INSULATION RESISTANCE: 1000 MEGOHMS MIN @ 25°C.
 - MOISTURE RESISTANCE: IP67 (MATED CONDITION)
 - MATING CYCLE DURABILITY: 100 CYCLES
 - RoHS COMPLIANT
- MATING PART: AT04-08P* RECEPTACLE
(X = A,B,C,D KEYS; * = MODIFICATIONS AND COLORS)
- ALL DIMENSIONS ARE FOR REFERENCE USE ONLY.

6 CONTACT SIZE AND REAR SEAL WIRE RANGE:

CONTACT SIZE	MIN. INSUL O.D.	MAX. INSUL O.D.	TYPICAL WIRE RANGE
16	2.24 mm (.088 in)	3.68 mm (.145 in)	14 - 20 AWG

TITLE: PLUG, 8 SOCKET, OVER-MOLDING, AT SERIES
DWG NO.: AT06-08SX-OMXXX
REV: A1
SH: 1
QF: 2

QUANTITY	PART NUMBER	DESCRIPTION	ITEM
MATERIALS LIST			
UNLESS OTHERWISE SPECIFIED: 1) All dimensions are in metric (mm). 2) Tolerances are as follows: 1 PL DEC ±0.30 Fractions ±1/64 2 PL DEC ±0.15 Angles ±1° 3 PL DEC ±0.08 3) Note reference =		SIGNATURES: J. HEAD DATE: 5JUL2017 CHECKED: - ENGINEER: - APPROVAL: - CUSTOMER: -	<div style="text-align: center;"> <h1>Amphenol</h1> <p>Sine Systems - www.amphenol-sine.com 44724 Morley Drive Clinton Township, MI 48036</p> </div>
MATERIAL SPECIFICATIONS:		PLUG, 8 SOCKET, OVER-MOLDING, AT SERIES	
PROCESS SPECIFICATIONS:		THIS DRAWING IS SUPPLIED FOR INFORMATION ONLY. DESIGN FEATURES, SPECIFICATIONS AND PERFORMANCE DATA SHOWN HEREON ARE THE PROPERTY OF THE AMPHENOL CORPORATION. NO RIGHTS OF REPRODUCTION ARE IMPLIED. ALL DIMENSIONS ARE SUBJECT TO NORMAL MANUFACTURING VARIATIONS.	
NEXT ASSY:		SIZE: B C- SCALE: NONE	DWG NO: AT06-08SX-OMXXX REVISION: A1 SHEET 1 OF 2

REVISIONS					
REV	ECO	DESCRIPTION	DATE	BY	APPR
A1	-	RELEASE	5JUL17	JAH	

P/N AT06-08SA-OMXXX
KEY-A CONFIGURATION
COLOR: GREY

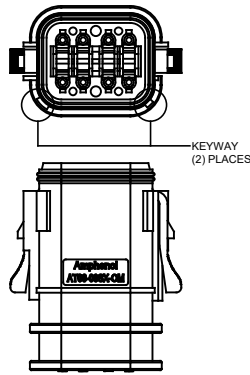

KEY-A CONFIGURATION	
COLOR	PART NUMBER
* GREY	AT06-08SA-OMGRY
BLACK	AT06-08SA-OMBLK
GREEN	AT06-08SA-OMGRN
BROWN	AT06-08SA-OMBRN

P/N AT06-08SB-OMXXX
KEY-B CONFIGURATION
COLOR: BLACK

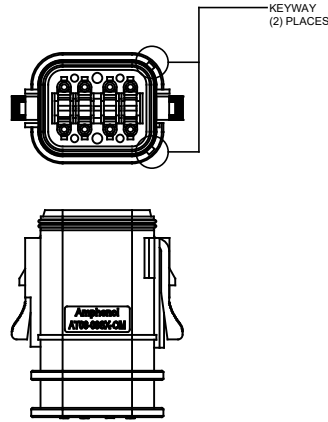

KEY-B CONFIGURATION	
COLOR	PART NUMBER
GREY	AT06-08SB-OMGRY
* BLACK	AT06-08SB-OMBLK
GREEN	AT06-08SB-OMGRN
BROWN	AT06-08SB-OMBRN

P/N AT06-08SC-OMXXX
KEY-C CONFIGURATION
COLOR: GREEN

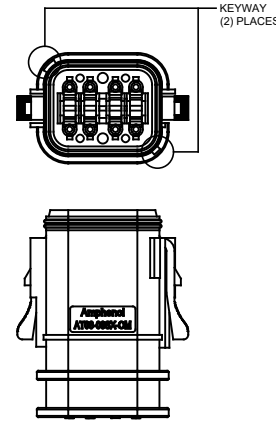

KEY-C CONFIGURATION	
COLOR	PART NUMBER
GREY	AT06-08SC-OMGRY
BLACK	AT06-08SC-OMBLK
* GREEN	AT06-08SC-OMGRN
BROWN	AT06-08SC-OMBRN

P/N AT06-08SD-OMXXX
KEY-D CONFIGURATION
COLOR: BROWN

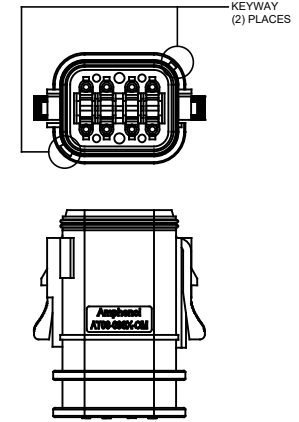

KEY-D CONFIGURATION	
COLOR	PART NUMBER
GREY	AT06-08SD-OMGRY
BLACK	AT06-08SD-OMBLK
GREEN	AT06-08SD-OMGRN
* BROWN	AT06-08SD-OMBRN

NOTE:

AN ASTERISKS (*) PLACED BEFORE THE COLOR DENOTES THE STANDARD MOLDED COLOR OF THE CONNECTORS SHOWN ABOVE.

OTHER COLORS SHOWN ARE AVAILABLE VIA SPECIAL ORDER.

SEE CHART		DESCRIPTION		ITEM
QUANTITY	PART NUMBER			
MATERIALS LIST				
<small>UNLESS OTHERWISE SPECIFIED</small> 1) All dimensions are in metric(mm). 2) Tolerances are as follows: 1 PL DEC ±0.30 2 PL DEC ±0.15 3 PL DEC ±0.08 3) Note reference = Δ		<small>SIGNATURES</small> DRAWN: J.HEAD CHECKED: . ENGINEER: APPROVAL: CUSTOMER:		<small>DATE</small> 5JUL2017
<small>MATERIAL SPECIFICATIONS:</small> THIS DRAWING IS SUPPLIED FOR INFORMATION ONLY. DESIGN FEATURES, SPECIFICATIONS AND PERFORMANCE DATA SHOWN HEREON ARE THE PROPERTY OF THE AMPHENOL CORPORATION. NO RIGHTS OF REPRODUCTION ARE IMPLIED. ALL DIMENSIONS ARE SUBJECT TO NORMAL MANUFACTURING VARIATIONS.		Amphenol Sine Systems - www.amphenol-sine.com 44724 Morley Drive Clinton Township, MI 48036		
<small>PROCESS SPECIFICATIONS:</small>		PLUG, 8 SOCKET, OVER-MOLDING, AT SERIES		
<small>NEXT ASSY:</small>		<small>SIZE</small> B C-	<small>TYPE</small> NONE	<small>DWG NO.</small> AT06-08SX-OMXXX
				<small>REVISION</small> A1
		<small>SCALE</small> NONE		<small>SHEET</small> 2 <small>OF</small> 2

TITLE: PLUG, 8 SOCKET, OVER-MOLDING, AT SERIES
DWG NO.: AT06-08SX-OMXXX
REV: A1
SH: 2
OF: 2