

3950X SERIES  
3.50mm HEADERS

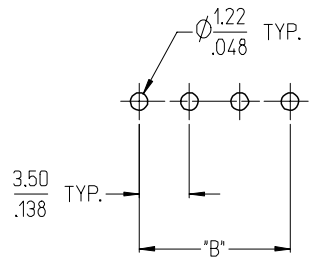

3952X & 3954X SERIES  
5.00mm HEADERS  
5.00mm 10 AMP FIXED

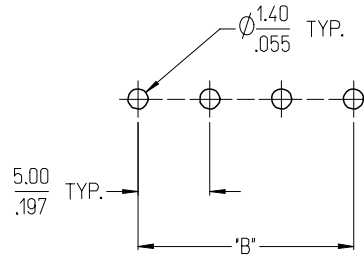

3953X SERIES  
5.08mm HEADERS

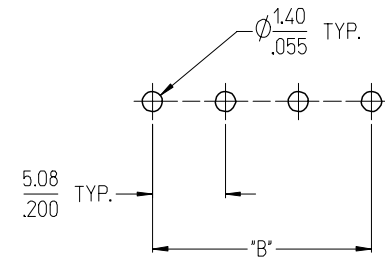

3951X SERIES  
3.81mm HEADERS

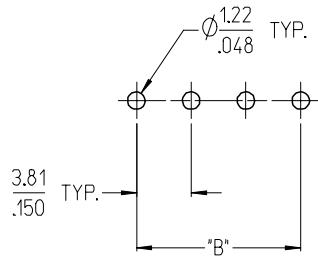

3954X SERIES  
5.00mm 15 AMP FIXED

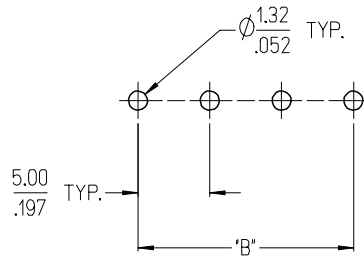

3954X SERIES  
5.08mm 15 AMP FIXED

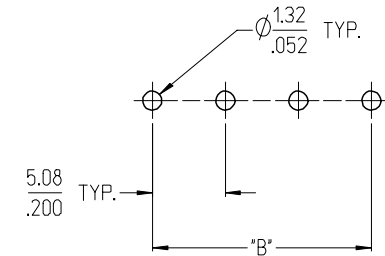

NOTES:

- REFER TO INDIVIDUAL PRODUCT SALES DRAWINGS FOR "B" DIMENSION.
- DOES NOT APPLY TO DUAL LEVEL HEADERS, SERIES 39528 AND 39538.
- TYP. = TYPICAL.

INITIAL RELEASE	EC NO: ETC2007-0096
DRWN: CLYORK	2006/10/02
CHKD: JMACNEIL	2006/10/04
APPR: JMACNEIL	2006/10/04
REV	DESCRIPTION
A	

QUALITY SYMBOLS
▽=0
▽=0

GENERAL TOLERANCES (UNLESS SPECIFIED)	
	mm INCH
4 PLACES	±.005 ±.002
3 PLACES	±.005 ±.002
2 PLACES	±0.13 ±.01
1 PLACE	±0.3 ±.01
ANGULAR ± 2 °	
DRAFT WHERE APPLICABLE MUST REMAIN WITHIN DIMENSIONS	

DIMENSION STYLE	
MM/IN	
DRAWN BY	DATE
C. YORK	2006/08/25
CHECKED BY	DATE
J. MACNEIL	2006/08/25
APPROVED BY	DATE
J. MACNEIL	2006/08/25
MATERIAL NO.	
--	

SCALE	DESIGN UNITS	THIRD ANGLE PROJECTION
3:1	INCH	☑
TITLE		
RECOMMENDED PCB LAYOUT FOR ESE TERMINAL BLOCKS		
MOLEX INCORPORATED		
DOCUMENT NO.	SHEET NO.	
SD-39501-002	1 OF 1	
THIS DRAWING CONTAINS INFORMATION THAT IS PROPRIETARY TO MOLEX INCORPORATED AND SHOULD NOT BE USED WITHOUT WRITTEN PERMISSION		

10 9 8 7 6 5 4 3 2 1

F

E

D

C

B

A

F

E

D

C

B

A

**SPECIFICATIONS:**

**1. Material:**

- (1). Body: PA66
- (2). Pin: Brass
- (3). Threaded insert: Brass

**2. Wire range: N/A**

**3. Electrical rating: 300V, 15A.**

**4. Wire strip length: N/A**

**5. Operating temperature: -40C to +105C.**

**6. Max torque: N/A**

**7. Insulation resistance: DC 500V, 500M.**

**8. Dielectric withstand: AC 2500V for 1 minute.**

**9. Breakdown voltage: 4000V.**

**10. A = (B + 15.0mm)**

**11. B = (N - 1) x P**

**13. C = (B + 10mm)**

**12. P (PITCH) = 5.0mm (.197").**

**13. N = Number of positions available 2 through 24.**

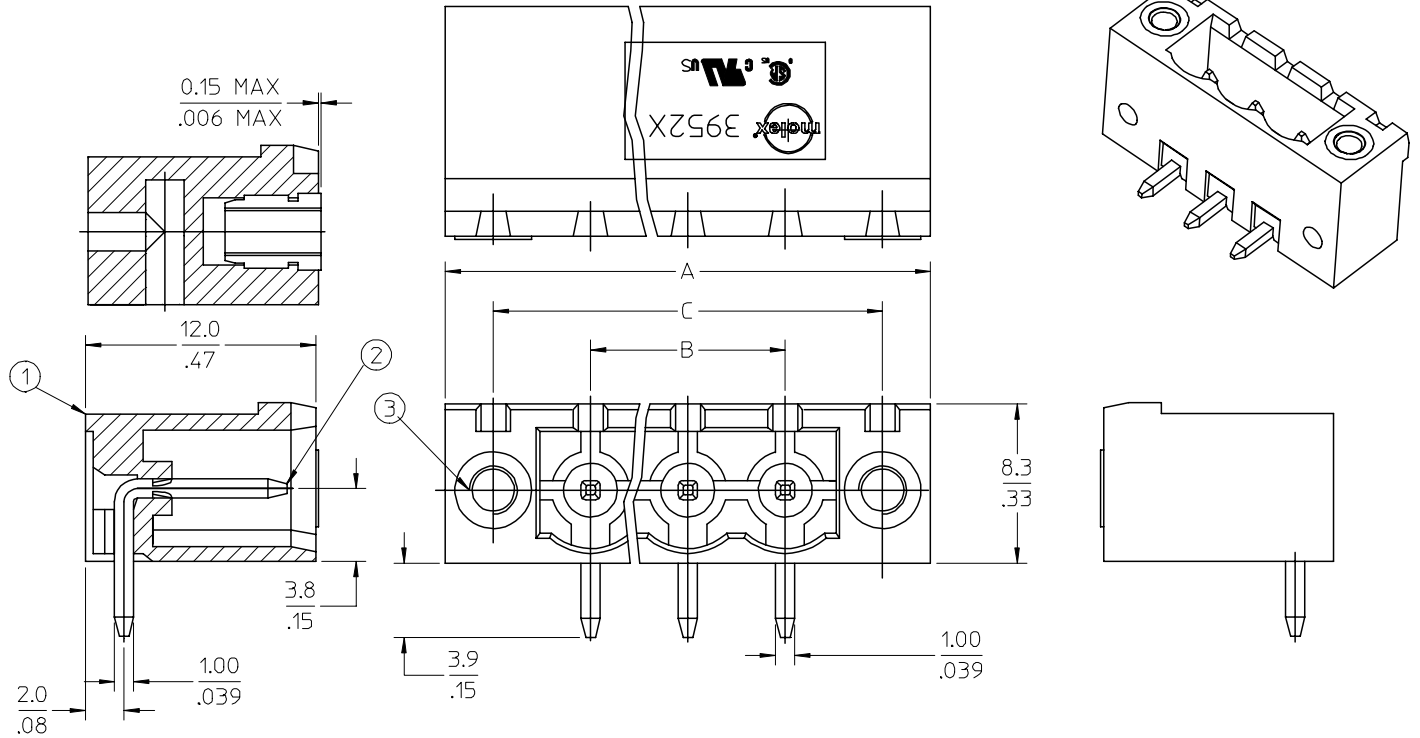

<b>ENTER DESCRIPTION</b> EC NO: NEO2006-0310 DRWNL: LROTHAUS 2006/01/09 CHKD: CYORK 2006/01/09 APPR: JPAMLIK 2006/01/10 DESCRIPTION	<b>QUALITY SYMBOLS</b> ▽=0 ▽=0	<b>GENERAL TOLERANCES (UNLESS SPECIFIED)</b>	<b>DIMENSION STYLE</b> MM/IN	<b>SCALE</b> 4:1	<b>DESIGN UNITS</b> INCH	THIRD ANGLE PROJECTION																											
		<table border="1"> <thead> <tr> <th></th> <th>mm</th> <th>INCH</th> </tr> </thead> <tbody> <tr> <td>4 PLACES</td> <td>± ---</td> <td>± .0015</td> </tr> <tr> <td>3 PLACES</td> <td>± 0.038</td> <td>± .005</td> </tr> <tr> <td>2 PLACES</td> <td>± 0.13</td> <td>± .01</td> </tr> <tr> <td>1 PLACE</td> <td>± 0.3</td> <td>± ---</td> </tr> </tbody> </table>		mm	INCH	4 PLACES	± ---	± .0015	3 PLACES	± 0.038	± .005	2 PLACES	± 0.13	± .01	1 PLACE	± 0.3	± ---	<table border="1"> <thead> <tr> <th>DRAWN BY</th> <th>DATE</th> </tr> </thead> <tbody> <tr> <td>LROTHAUS</td> <td>12/6/05</td> </tr> <tr> <th>CHECKED BY</th> <th>DATE</th> </tr> <tr> <td>C. YORK</td> <td>01/06/06</td> </tr> <tr> <th>APPROVED BY</th> <th>DATE</th> </tr> <tr> <td></td> <td></td> </tr> </tbody> </table>	DRAWN BY	DATE	LROTHAUS	12/6/05	CHECKED BY	DATE	C. YORK	01/06/06	APPROVED BY	DATE			<b>TITLE</b> 5.0MM, EURO HEADER, RIGHT ANGLE, MOUNTING		
		mm	INCH																														
	4 PLACES	± ---	± .0015																														
3 PLACES	± 0.038	± .005																															
2 PLACES	± 0.13	± .01																															
1 PLACE	± 0.3	± ---																															
DRAWN BY	DATE																																
LROTHAUS	12/6/05																																
CHECKED BY	DATE																																
C. YORK	01/06/06																																
APPROVED BY	DATE																																
	DRAFT WHERE APPLICABLE MUST REMAIN WITHIN DIMENSIONS	MATERIAL NO. SEE CHART	DOCUMENT NO. SD-39526-002	MOLEX INCORPORATED																													
		SIZE B	THIS DRAWING CONTAINS INFORMATION THAT IS PROPRIETARY TO MOLEX INCORPORATED AND SHOULD NOT BE USED WITHOUT WRITTEN PERMISSION																														

Description	Circuit size	Material Numbers												Dimensional Information					
		Black						Green											
		100% Tin			30 u" Gold			100% Tin			30 u" Gold			Dim. A		Dim B		Dim. C	
		Printing Options			Printing Options			Printing Options			Printing Options								
None	10A	11A	None	10A	11A	None	10A	11A	None	10A	11A	mm	inch	mm	inch	mm	inch		
5.0mm, Euro Header, Right Angle, Mounting Ends	2	395260002	395260102	395260202	395260502	395260602	395260702	395265002	395265102	395265202	395265502	395265702	20.00	0.787	5.00	0.197	15.00	0.591	
5.0mm, Euro Header, Right Angle, Mounting Ends	3	395260003	395260103	395260203	395260503	395260603	395260703	395265003	395265103	395265203	395265503	395265703	25.00	0.984	10.00	0.394	20.00	0.787	
5.0mm, Euro Header, Right Angle, Mounting Ends	4	395260004	395260104	395260204	395260504	395260604	395260704	395265004	395265104	395265204	395265504	395265704	30.00	1.181	15.00	0.591	25.00	0.984	
5.0mm, Euro Header, Right Angle, Mounting Ends	5	395260005	395260105	395260205	395260505	395260605	395260705	395265005	395265105	395265205	395265505	395265705	35.00	1.378	20.00	0.787	30.00	1.181	
5.0mm, Euro Header, Right Angle, Mounting Ends	6	395260006	395260106	395260206	395260506	395260606	395260706	395265006	395265106	395265206	395265506	395265706	40.00	1.575	25.00	0.984	35.00	1.378	
5.0mm, Euro Header, Right Angle, Mounting Ends	7	395260007	395260107	395260207	395260507	395260607	395260707	395265007	395265107	395265207	395265507	395265707	45.00	1.772	30.00	1.181	40.00	1.575	
5.0mm, Euro Header, Right Angle, Mounting Ends	8	395260008	395260108	395260208	395260508	395260608	395260708	395265008	395265108	395265208	395265508	395265708	50.00	1.969	35.00	1.378	45.00	1.772	
5.0mm, Euro Header, Right Angle, Mounting Ends	9	395260009	395260109	395260209	395260509	395260609	395260709	395265009	395265109	395265209	395265509	395265709	55.00	2.165	40.00	1.575	50.00	1.969	
5.0mm, Euro Header, Right Angle, Mounting Ends	10	395260010	395260110	395260210	395260510	395260610	395260710	395265010	395265110	395265210	395265510	395265710	60.00	2.362	45.00	1.772	55.00	2.165	
5.0mm, Euro Header, Right Angle, Mounting Ends	11	395260011	395260111	395260211	395260511	395260611	395260711	395265011	395265111	395265211	395265511	395265711	65.00	2.559	50.00	1.969	60.00	2.362	
5.0mm, Euro Header, Right Angle, Mounting Ends	12	395260012	395260112	395260212	395260512	395260612	395260712	395265012	395265112	395265212	395265512	395265712	70.00	2.756	55.00	2.165	65.00	2.559	
5.0mm, Euro Header, Right Angle, Mounting Ends	13	395260013	395260113	395260213	395260513	395260613	395260713	395265013	395265113	395265213	395265513	395265713	75.00	2.953	60.00	2.362	70.00	2.756	
5.0mm, Euro Header, Right Angle, Mounting Ends	14	395260014	395260114	395260214	395260514	395260614	395260714	395265014	395265114	395265214	395265514	395265714	80.00	3.150	65.00	2.559	75.00	2.953	
5.0mm, Euro Header, Right Angle, Mounting Ends	15	395260015	395260115	395260215	395260515	395260615	395260715	395265015	395265115	395265215	395265515	395265715	85.00	3.346	70.00	2.756	80.00	3.150	
5.0mm, Euro Header, Right Angle, Mounting Ends	16	395260016	395260116	395260216	395260516	395260616	395260716	395265016	395265116	395265216	395265516	395265716	90.00	3.543	75.00	2.953	85.00	3.346	
5.0mm, Euro Header, Right Angle, Mounting Ends	17	395260017	395260117	395260217	395260517	395260617	395260717	395265017	395265117	395265217	395265517	395265717	95.00	3.740	80.00	3.150	90.00	3.543	
5.0mm, Euro Header, Right Angle, Mounting Ends	18	395260018	395260118	395260218	395260518	395260618	395260718	395265018	395265118	395265218	395265518	395265718	100.00	3.937	85.00	3.346	95.00	3.740	
5.0mm, Euro Header, Right Angle, Mounting Ends	19	395260019	395260119	395260219	395260519	395260619	395260719	395265019	395265119	395265219	395265519	395265719	105.00	4.134	90.00	3.543	100.00	3.937	
5.0mm, Euro Header, Right Angle, Mounting Ends	20	395260020	395260120	395260220	395260520	395260620	395260720	395265020	395265120	395265220	395265520	395265720	110.00	4.331	95.00	3.740	105.00	4.134	
5.0mm, Euro Header, Right Angle, Mounting Ends	21	395260021	395260121	395260221	395260521	395260621	395260721	395265021	395265121	395265221	395265521	395265721	115.00	4.528	100.00	3.937	110.00	4.331	
5.0mm, Euro Header, Right Angle, Mounting Ends	22	395260022	395260122	395260222	395260522	395260622	395260722	395265022	395265122	395265222	395265522	395265722	120.00	4.724	105.00	4.134	115.00	4.528	
5.0mm, Euro Header, Right Angle, Mounting Ends	23	395260023	395260123	395260223	395260523	395260623	395260723	395265023	395265123	395265223	395265523	395265723	125.00	4.921	110.00	4.331	120.00	4.724	
5.0mm, Euro Header, Right Angle, Mounting Ends	24	395260024	395260124	395260224	395260524	395260624	395260724	395265024	395265124	395265224	395265524	395265724	130.00	5.118	115.00	4.528	125.00	4.921	

SEE SHEET 1 EC NO: NEC02006-0310 DRWN: LROTHAUS 2006/01/09 CHKD: CYORK 2006/01/09 APPR: J.P.A.M.L.I.C.K 2006/01/10	QUALITY SYMBOLS ▽=0 ▽=0	GENERAL TOLERANCES (UNLESS SPECIFIED) mm INCH 4 PLACES ± --- ±.0015 3 PLACES ±0.038 ±.005 2 PLACES ±0.13 ±.01 1 PLACE ±0.3 ± --- ANGULAR ± 2 °	DIMENSION STYLE MM/IN DRAWN BY DATE LROTHAUS 12/6/05 CHECKED BY DATE C. YORK 01/04/06 APPROVED BY DATE	SCALE 4:1 DESIGN UNITS INCH THIRD ANGLE PROJECTION	TITLE 5.0MM, EURO HEADER, RIGH ANGLE, MOUNTING	
	MATERIAL NO. SEE CHART	DOCUMENT NO. SD-39526-002	SHEET NO. 2 OF 2	MOLEX INCORPORATED		
	DRAFT WHERE APPLICABLE MUST REMAIN WITHIN DIMENSIONS			THIS DRAWING CONTAINS INFORMATION THAT IS PROPRIETARY TO MOLEX INCORPORATED AND SHOULD NOT BE USED WITHOUT WRITTEN PERMISSION		
	SIZE B					