



### Features

- High Gain = 34dB
- $P_{OUT} = 30\text{dBm} < 3\% \text{ EVM}$
- 2.4GHz to 2.7GHz Frequency Range
- Integrated 3-stage PA
- Integrated Power Detector

### Applications

- WiFi IEEE802.11b/g/n Applications
- Picocell, Femtocell
- Customer Premises Equipment (CPE)
- WiMAX IEEE802.16e
- Spread-Spectrum and MMDS Systems
- LTE

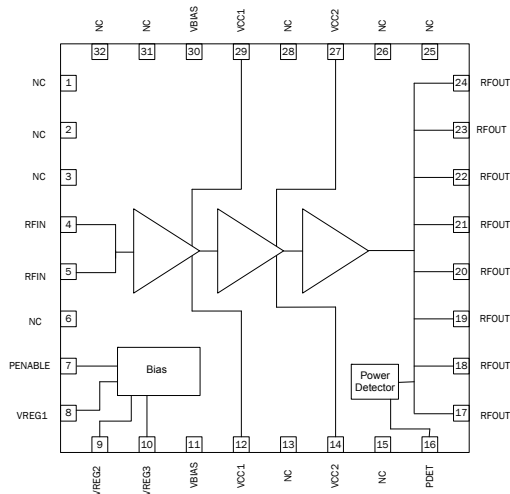

Functional Block Diagram

### Product Description

The RF5652 is a High Power Amplifier that is intently specified to address IEEE 802.11b/g/n WiFi 2.4GHz to 2.5GHz customer premises equipment (CPE) applications; and WiMAX (2.5GHz to 2.7GHz) CPE applications. The PA has an intergrated 3-stage Linear Power Amplier, with 30dBm (1 Watt) linear power at PA output. This product will be housed in an 5mmx5mm QFN.

### Ordering Information

|               |  |
|---------------|--|
| RF5652        | Standard 25 piece bag                              |
| RF5652SB      | Standard 5 piece bag                               |
| RF5652SR      | Standard 100 piece reel                            |
| RF5652TR13    | Standard 2500 piece reel                           |
| RF5652PCK-410 | Evaluation Board 2.4GHz to 2.5GHz with 5 piece bag |
| RF5652PCK-411 | Evaluation Board 2.5GHz to 2.7GHz with 5 piece bag |

### Optimum Technology Matching® Applied

- |   |                                      |                                     |                                   |
|---|--------------------------------------|-------------------------------------|-----------------------------------|
| <input type="checkbox"/> GaAs HBT             | <input type="checkbox"/> SiGe BiCMOS | <input type="checkbox"/> GaAs pHEMT | <input type="checkbox"/> GaN HEMT |
| <input type="checkbox"/> GaAs MESFET          | <input type="checkbox"/> Si BiCMOS   | <input type="checkbox"/> Si CMOS    | <input type="checkbox"/> RF MEMS  |
| <input checked="" type="checkbox"/> InGaP HBT | <input type="checkbox"/> SiGe HBT    | <input type="checkbox"/> Si BJT     | <input type="checkbox"/> LDMOS    |

## Absolute Maximum Ratings

| Parameter                      | Rating        | Unit |
|--------------------------------|---------------|------|
| Supply Voltage (RF Applied)    | -0.5 to +5.25 | V    |
| Supply Voltage (No RF Applied) | -0.5 to +6.0  | V    |
| DC Supply Current              | 2000          | mA   |
| Input RF Power                 | +10*          | dBm  |
| Operating Ambient Temperature  | -40 to +85    | °C   |
| Storage Temperature            | -40 to +150   | °C   |
| Moisture Sensitivity           | MSL2          |      |

\*Maximum Input Power with a 50Ω load.



**Caution!** ESD sensitive device.

Exceeding any one or a combination of the Absolute Maximum Rating conditions may cause permanent damage to the device. Extended application of Absolute Maximum Rating conditions to the device may reduce device reliability. Specified typical performance or functional operation of the device under Absolute Maximum Rating conditions is not implied.

RoHS status based on EUDirective2002/95/EC (at time of this document revision).

The information in this publication is believed to be accurate and reliable. However, no responsibility is assumed by RF Micro Devices, Inc. ("RFMD") for its use, nor for any infringement of patents, or other rights of third parties, resulting from its use. No license is granted by implication or otherwise under any patent or patent rights of RFMD. RFMD reserves the right to change component circuitry, recommended application circuitry and specifications at any time without prior notice.

| Parameter   | Specification |      |        | Unit    | Condition  |
|---|---------------|------|--------|---------|--|
|   | Min.          | Typ. | Max.   |         |  |
| <b>Operating Conditions</b>                         |               |      |        |         | T=25 °C, V <sub>CC</sub> =5.0V, V <sub>REG</sub> =2.85V, using an IEEE802.11g waveform, 54Mbps, unless otherwise noted |
| Frequency   | 2412          |      | 2484   | MHz     | Compliance with standard 802.11b and 802.11g   |
| 802.11g & 11n Output Power                          | 29            | 30   |        | dBm     |  |
| EVM   |               | 2.5  | 3      | %       |  |
| Gain  | 31.5          | 33.5 | 37.5   | dB      |  |
| Gain variation over Temp                            |               |      | +/-2.5 | dB      |  |
| Second Harmonic                                     |               | -25  |        | dBm/MHz |  |
| Third Harmonic                                      |               | -50  |        | dBm/MHz |  |
| Power Detect Range                                  | 0.2           |      | 2.8    | V       | P <sub>OUT</sub> = 0 to 30dBm, usable range from 0 to 32dBm  |
| Power Detect Power Range                            | 10            |      | 33     | dBm     |  |
| Input Return Loss - Tx <sub>in</sub> pin            | 10            | 15   |        | dB      | In specified frequency band  |
| Output Return Loss                                  | 8             | 10   |        | dB      | In specified frequency band  |
| Operating Current                                   |               | 1450 | 1650   | mA      | At P <sub>OUT</sub> = 30dBm  |
| Quiescent Current                                   |               | 950  | 1050   | mA      | V <sub>CC</sub> = 5.0, V <sub>REG</sub> = 2.85V & RF=OFF   |
| I <sub>REG</sub>                                    |               | 13   | 18     | mA      |  |
| P <sub>DOWN</sub> Current                           |               |      | 30     | mA      | P <sub>DOWN</sub> = 0V, V <sub>REG</sub> = 2.85V, V <sub>CC</sub> = 5V   |
| Leakage Current                                     |               | 0.25 | 0.4    | mA      | V <sub>CC</sub> = 5V, V <sub>REG</sub> = 0V, P <sub>DOWN</sub> = 0V  |
| Power Supply - V <sub>CC</sub>                      |               | 5    | 5.25   | V       |  |
| Power supply - V <sub>REG</sub> (at Eval Board pin) | 2.8           | 2.85 | 3      | V       |  |
| <b>Generic Performance</b>                          |               |      |        |         |  |
| Turn-on time from setting of V <sub>REG</sub> 's    |               | 650  |        | nsec    | Output stable to within 90% of final gain  |
| Stability   | -25           |      | 34     | dBm     | No spurs above -47dBm into 4:1 VSWR  |
| Max Pin (Ruggedness - 10:1 VSWR at Ant)             |               |      | 6      | dBm     | No damage for VSWR=10:1  |
| Max Pin (Ruggedness - 50Ω)                          |               |      | 15     | dBm     | No damage for VSWR=1:1   |
| CW P1dB   |               | 37   |        | dBm     | TX mode in 50% Duty Cycle  |
| ESD   |               |      |        |         |  |
| Human Body Mode                                     | 500           |      |        | V       | EIA/JESD22-114A RF pins  |
|   | 500           |      |        | V       | EIA/JESD22-114A DC pins  |
| Charge Device Model                                 | 500           |      |        | V       | JESD22-C101C all pins  |
| Thermal Resistance                                  |               |      |        |         |  |
| R <sub>THJ</sub>                                    |               | 8.5  |        | °C/W    |  |

| Parameter   | Specification |      |        | Unit    | Condition  |
|---|---------------|------|--------|---------|--|
|   | Min.          | Typ. | Max.   |         |  |
| <b>Typical Conditions</b>                           |               |      |        |         | T=25 °C, V <sub>CC</sub> =5.0V, V <sub>REG</sub> =2.85V, using an IEEE802.16e waveform, 10MHz BW, unless otherwise noted |
| Frequency   | 2500          |      | 2700   | MHz     | Compliance with standard 802.16e   |
| 802.16e Output Power                                | 29            | 30   |        | dBm     |  |
| EVM   |               | 2.5  |        | %       |  |
| Gain  | 32            | 34   |        | dB      |  |
| Gain variation over Temp                            |               |      | +/-2.5 | dB      |  |
| Second Harmonic                                     |               | -25  |        | dBm/MHz |  |
| Third Harmonic                                      |               | -50  |        | dBm/MHz |  |
| Low Gain Mode - Gain Reduction                      | 20            | 25   |        | dB      | Drop in gain vs. high gain mode by setting V <sub>REG2</sub> =0  |
| Power Detect Range                                  | 0.2           |      | 2.8    | V       | P <sub>OUT</sub> = 0 to 30dBm, usable range from 0 to 33dBm  |
| Power Detect Power Range                            | 10            |      | 33     | dBm     |  |
| Input Return Loss - Tx_in pin                       | 10            | 15   |        | dB      | In specified frequency band  |
| Output Return Loss                                  | 8             | 10   |        | dB      | In specified frequency band  |
| Operating Current                                   |               | 1500 | 1800   | mA      | At P <sub>OUT</sub> = 30dBm  |
| Quiescent Current                                   |               | 950  | 1050   | mA      | V <sub>CC</sub> = 5.0, V <sub>REG</sub> = 2.85V and RF=OFF   |
| I <sub>REG</sub>                                    |               | 13   | 18     | mA      |  |
| P <sub>DOWN</sub> Current                           |               |      | 30     | mA      | P <sub>DOWN</sub> = 0V, V <sub>REG</sub> = 2.85V, V <sub>CC</sub> = 5V   |
| Leakage Current                                     |               | 0.25 | 0.4    | mA      | V <sub>CC</sub> = 5V, V <sub>REG</sub> =0V, P <sub>DOWN</sub> = 0V   |
| Power Supply - V <sub>CC</sub>                      |               | 5    | 5.25   | V       |  |
| Power supply - V <sub>REG</sub> (at Eval Board pin) | 2.8           | 2.85 | 3      | V       |  |

| Pin      | Function | Description  |
|----------|----------|--|
| 1        | NC       | No Connection internal. Can be grounded or left open.  |
| 2        | NC       | No Connection internal. Can be grounded or left open.  |
| 3        | NC       | No Connection internal. Can be grounded or left open.  |
| 4        | RFIN     | RF input, internal DC blocked.   |
| 5        | RFIN     | RF input, internal DC blocked.   |
| 6        | NC       | No Connection internal. Can be grounded or left open.  |
| 7        | PENABLE  | PA Enable pin; Apply <0.6VDC to power down the three power amplifier stages. Apply 1.75VDC to 5.0VDC to enable PA.   |
| 8        | VREG1    | First stage bias voltage. This Pin requires regulated supply for best performance.   |
| 9        | VREG2    | Second stage bias voltage. This Pin requires regulated supply for best performance.  |
| 10       | VREG3    | Third stage bias voltage. This Pin requires regulated supply for best performance.   |
| 11       | VBIAS    | Supply voltage for the bias reference and control circuits. May be connected with VCC1, VCC2, VCC3 as long as appropriate isolation is provided.   |
| 12       | VCC1     | This pin is connected internally to the collector of the 1st stage RF device. To achieve specified performance, the layout of these pins should match the Recommended Land Pattern.        |
| 13       | NC       | No Connection internal. Can be grounded or left open.  |
| 14       | VCC2     | This pin is connected internally to the collector of the 2nd stage RF device. To achieve specified performance, the layout of these pins should match the Recommended Land Pattern.        |
| 15       | NC       | No Connection internal. Can be grounded or left open.  |
| 16       | PDET     | Power detector provides an output voltage proportional to the RF output power level.   |
| 17       | RFOUT    | RF Output. Need external DC block.   |
| 18       | RFOUT    | RF Output. Need external DC block.   |
| 19       | RFOUT    | RF Output. Need external DC block.   |
| 20       | RFOUT    | RF Output. Need external DC block.   |
| 21       | RFOUT    | RF Output. Need external DC block.   |
| 22       | RFOUT    | RF Output. Need external DC block.   |
| 23       | RFOUT    | RF Output. Need external DC block.   |
| 24       | RFOUT    | RF Output. Need external DC block.   |
| 25       | NC       | No Connection internal. Can be grounded or left open.  |
| 26       | NC       | No Connection internal. Can be grounded or left open.  |
| 27       | VCC2     | This pin is connected internally to the collector of the 2nd stage RF device. To achieve specified performance, the layout of these pins should match the Recommended Land Pattern.        |
| 28       | NC       | No Connection internal. Can be grounded or left open.  |
| 29       | VCC1     | This pin is connected internally to the collector of the 1st stage RF device. To achieve specified performance, the layout of these pins should match the Recommended Land Pattern.        |
| 30       | VBIAS    | Supply voltage for the bias reference and control circuits. May be connected with VCC1, VCC2, VCC3 as long as appropriate isolation is provided.   |
| 31       | NC       | No Connection internal. Can be grounded or left open.  |
| 32       | NC       | No Connection internal. Can be grounded or left open.  |
| PkG Base | GND      | Ground connection. The back side of the package should be connected to the ground plane through as short a connection as possible, for example, PCB vias under the device are recommended. |

## Theory of Operation and Applications

The RF5652 is a High Power Amplifier (PA) for high performance WiFi applications in the 2.4GHz to 2.5GHz ISM band, to address IEEE 802.11b/g/n customer premises equipment (CPE) application, and WiMAX 2.5GHz to 2.7GHz CPE application. The RF5652 has an integrated three stage linear Power Amplifier to provide 30dBm (1 Watt) linear power at PA output. The device is manufactured using InGaP HBT processes in a 5mm x 5mm x 0.85mm QFN package. To reduce the design and optimization process on the customer application, the evaluation board layout should be copied as close as possible, in particular the ground and via configurations. Gerber files of RFMD PCB designs can be provided upon request. The supply voltage lines should present an RF short to the FEM by using bypass capacitors on the  $V_{CC}$  traces. To simplify bias conditions, the RF5652 requires a single positive supply voltage ( $V_{CC}$ ), a positive current control bias ( $V_{REG}$ ) supply and a high impedance enable pin (PENABLE). The built-in Power Detector of the RF5652 can be used as power monitor in the system.

### RF5652 PA Operation

The RF5652 has a typical gain of 34dB from 2.4GHz to 2.5GHz, and delivers > 29.5dBm typical output power in 11n HT20 MCS7 and >30dBm typical in 11g 54Mbps with a Dynamic EVM < 3%. For WiMAX application, RF5652 delivers 30dBm typical output power in WiMAX 10MHz BW with EVM < 2.5%. The RF5652 requires a single positive of 5.0V to operate at full specifications. The  $V_{REG}$  pin requires a regulated supply at 2.85V to maintain nominal bias current.

### RF5652 Biasing Instructions to the Eval board:

- 802.11b/g/n Transmit:
- Connect the PA to a signal generator at the input and a spectrum analyzer at the output. Set the Pin at signal generator is at -20dBm.
- Bias  $V_{CC}$  to 5.0V first with  $V_{REG}=0.0V$ . If available, enable the current limiting function of the power supply to 2000 mA.
- Turn on  $V_{REG}$  to 2.85V (typ.).
- On  $V_{REG}$  (of Eval board), regulated supply is recommended. Be extremely careful not to exceed 3.0V on the  $V_{REG}$  pin or the part may exceed device current limits.
- Turn on Pdown to 2.85V (typ.). Pdown Pin can be tied to  $V_{REG}$  supply.
- The above steps apply to WIMAX Transmit test.

**NOTE: It is important to adjust the  $V_{CC}$  voltage source so that +5V is measured at the board; and the +2.85V of  $V_{REG}$  is measured at the board. The high collector currents will drop the collector voltage significantly if long leads are used. Adjust the bias voltage to compensate.**

- Turn on RF of signal generator and gradually increase power level to the rated power.

**CAUTION: If the input signal exceeds the maximum rated power, the RF5652 Evaluation Board can be permanently damaged.**

- To turn off PA, turn off RF power of signal generator; then Pdown,  $V_{REG}$  and  $V_{CC}$ .

### General Layout Guidelines and considerations:

For best performance the following layout guidelines and considerations must be followed regardless of final use or configuration:

1. The ground pad of the RF5652 has special electrical and thermal grounding requirements. This pad is the main RF ground and main thermal conduit path for heat dissipation. The GND pad and vias pattern and size used on the RFMD evaluation board should be replicated. The RFMD layout files in Gerber format can be provided upon request. Ground paths (under device) should be made as short as possible.
2. The RF lines should be well separated with solid ground in between the traces to eliminate any possible RF leakages or cross-talking.

3. Bypass capacitors should be used on the DC supply lines. The  $V_{CC}$  lines may be connected after the RF bypass and decoupling capacitors to provide better isolation between each  $V_{CC}$  line.

### RF5652 PA production and system calibration recommendation:

It's highly recommended to follow the DC biasing step and RF power settings in the production calibration or test.

1. Connect the RF cables of input and output then connect to the proper equipment.
2. Apply  $V_{CC}$ , then  $V_{REG}$  as per the data sheet recommendations.
3. Set PA in TX mode.
4. Apply PENABLE = high.
5. Set RF input to the desired frequency and initial RF input power at -20dBm. This will insure the Power amplifier is in a linear state and not over driven.
6. Sweep RF from low to high output power and take measurements at the rated output power.
7. Insure that the output power at turn on doesn't saturate the power amplifier. The recommended output power should be about 10dB to 20dB below the nominal input power. xxStart calibrating from low to high power in reasonable steps until the rated power is reached then take the measurements.

**CAUTION: If the input signal exceeds the maximum rated input power specifications, the RF5652 could be permanently damaged.**

**Package Drawing**

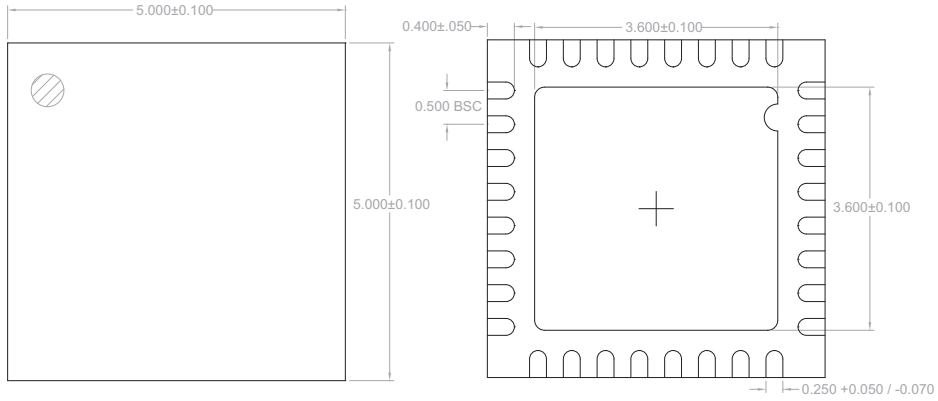

**TOP VIEW**

**BOTTOM VIEW**

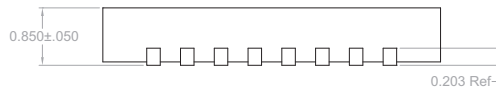

**SIDE VIEW**

A = 0.270 x 0.528 (mm)  
 B = 0.528 x 0.270 (mm)  
 C = 3.600 x 3.600 (mm)

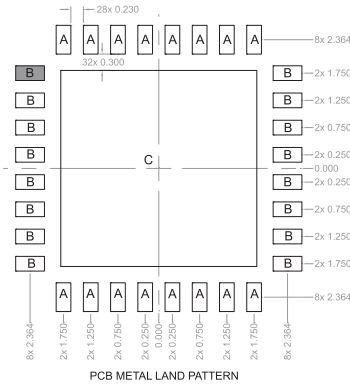

**PCB METAL LAND PATTERN**

A = 0.400 x 0.658 (mm)  
 B = 0.658 x 0.400 (mm)  
 C = 3.730 x 3.730 (mm)

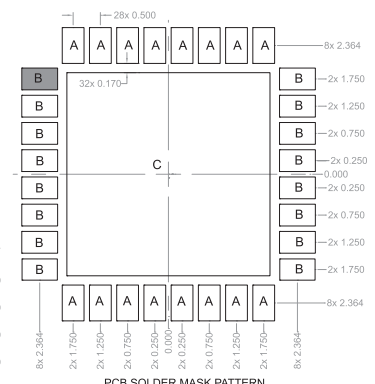

**PCB SOLDER MASK PATTERN**

A = 0.243 x 0.475 (mm)  
 B = 0.475 x 0.243 (mm)  
 C = 1.530 x 1.530 (mm)

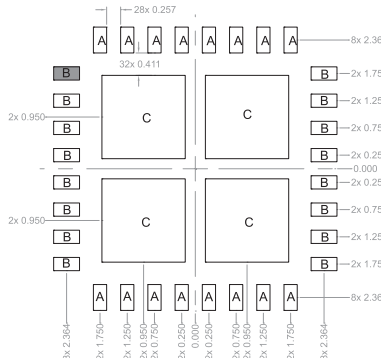

**PCB STENCIL PATTERN**

Note: Thermal vias for center slug "C" should be incorporated into the PCB design. The number and size of thermal vias will depend on the application, the power dissipation, and the electrical requirements. Example of the number and size of vias can be found on the RFMD evaluation board layout..

## Pin Out

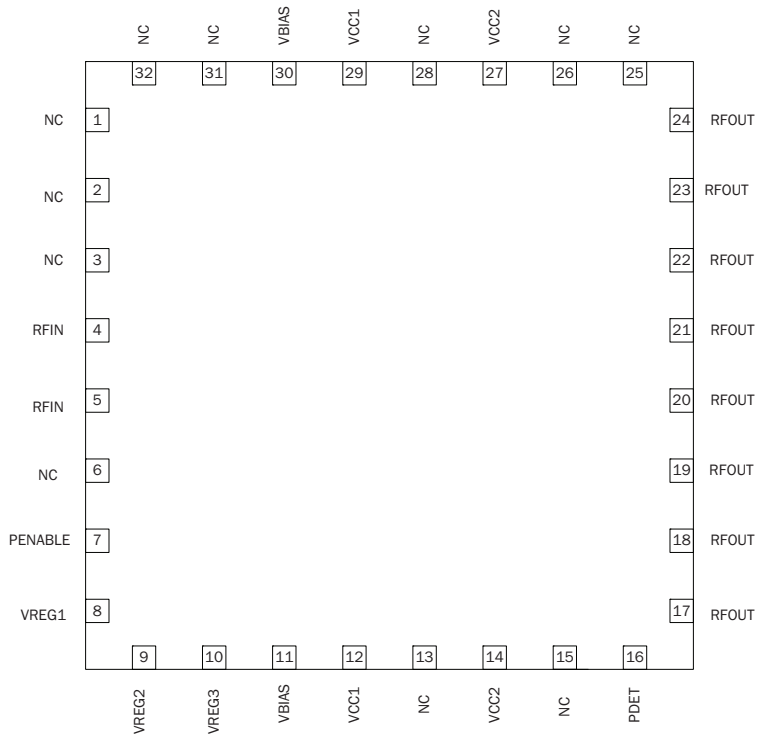



**Evaluation Board Schematic**  
WiFi Application

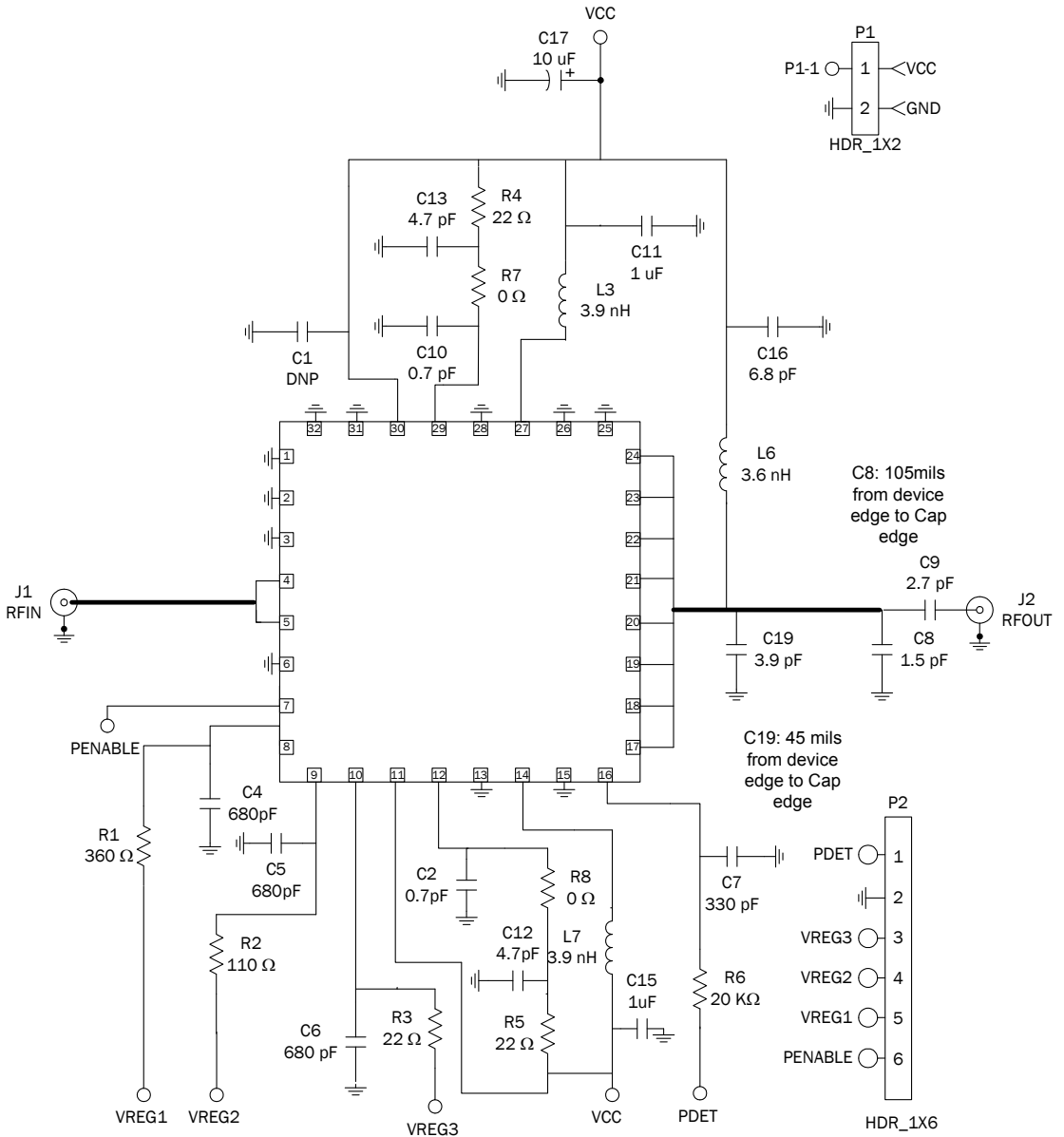

## WLAN Evaluation Board BOM

| Description                            | Qty | Reference Designator       | Manufacturer                | Manufacturer's P/N |
|--|-----|----------------------------|-----------------------------|--------------------|
| CAP, 10uF, 10%, 10V, X5R, 0805         | 1   | C17                        | Murata Electronics          | GRM21BR61A106KE19L |
| CAP, 6.8pF, 5%, 50V, C0G, 0402         | 1   | C16                        | Murata Electronics          | GJM1555C1H6R8CB01E |
| CAP, 680pF, 5%, 50V, C0G, 0402         | 2   | C5, C6                     | Murata Electronics          | GRM1555C1H681JZ01D |
| CAP, 330pF, 10%, 50V, X7R, 0402        | 1   | C7                         | Murata Electronics          | GRM155R71H331KA01E |
| CAP, 1uF, 10%, 10V, X5R, 0402          | 2   | C11, C15                   | Murata Electronics          | GRM155R61A105KE15D |
| CAP, 4.7pF, +/-0.25pF, 50V, HI-Q, 0402 | 2   | C12, C13                   | Murata Electronics          | GJM1555C1H4R7CB01E |
| CAP, 0.7pF, +/-0.25pF, 50V, HI-Q, 0402 | 2   | C2, C10                    | Murata Electronics          | GRM1555C1HR70BZ01D |
| CAP, 1.5pF, +/-0.25pF, 50V, HI-Q, 0402 | 1   | C8 - 105mils from QFN edge | Murata Electronics          | GJM1555C1H1R5CB01E |
| CAP, 3.9pF, +/-0.25pF, 50V, HI-Q, 0402 | 1   | C19 - 45mils from QFN edge | Murata Electronics          | GRM1555C1H3R9CZ01E |
| CAP, 2.7pF, +/-0.25pF, 50V, HI-Q, 0402 | 1   | C9                         | Murata Electronics          | GRM1555C1H2R7CZ01E |
| RES, 360 OHM, 5%, 1/16W, 0402          | 1   | R1                         | Kamaya, Inc                 | RMC1/16S-361JTH    |
| RES, 110 OHM, 5%, 1/16W, 0402          | 1   | R2                         | Panasonic Industrial Co     | ERJ-2GJE1111X      |
| RES, 22 OHM, 5%, 1/16W, 0402           | 3   | R3, R4, R5                 | Kamaya, Inc                 | RMC1/16S-220JTH    |
| RES, 20 KOHM, 5%, 1/16W, 0402          | 1   | R6                         | KOA Speer Electronics, Inc. | RK73H1ETP2002F     |
| IND, 3.9nH, 5%, WW, 0603               | 1   | L6                         | Coilcraft                   | 0603HC-3N9XJLW     |
| RES, 0 OHM, 0402                       | 2   | R7, R8                     | Kamaya, Inc                 | RMC1/16SJPTH       |
| IND, 3.9nH, +/-0.3nH, ML, 0402         | 2   | L3, L7                     | Murata Electronics          | LQP15MN3N9B02D     |
| DNI                                    | 4   | C1, C3, C4, C14            |                             |                    |
| RF5652 5x5mm, QFN32                    | 1   | U1                         | RFMD                        |                    |

**Evaluation Board Schematic**  
WiMAX Application

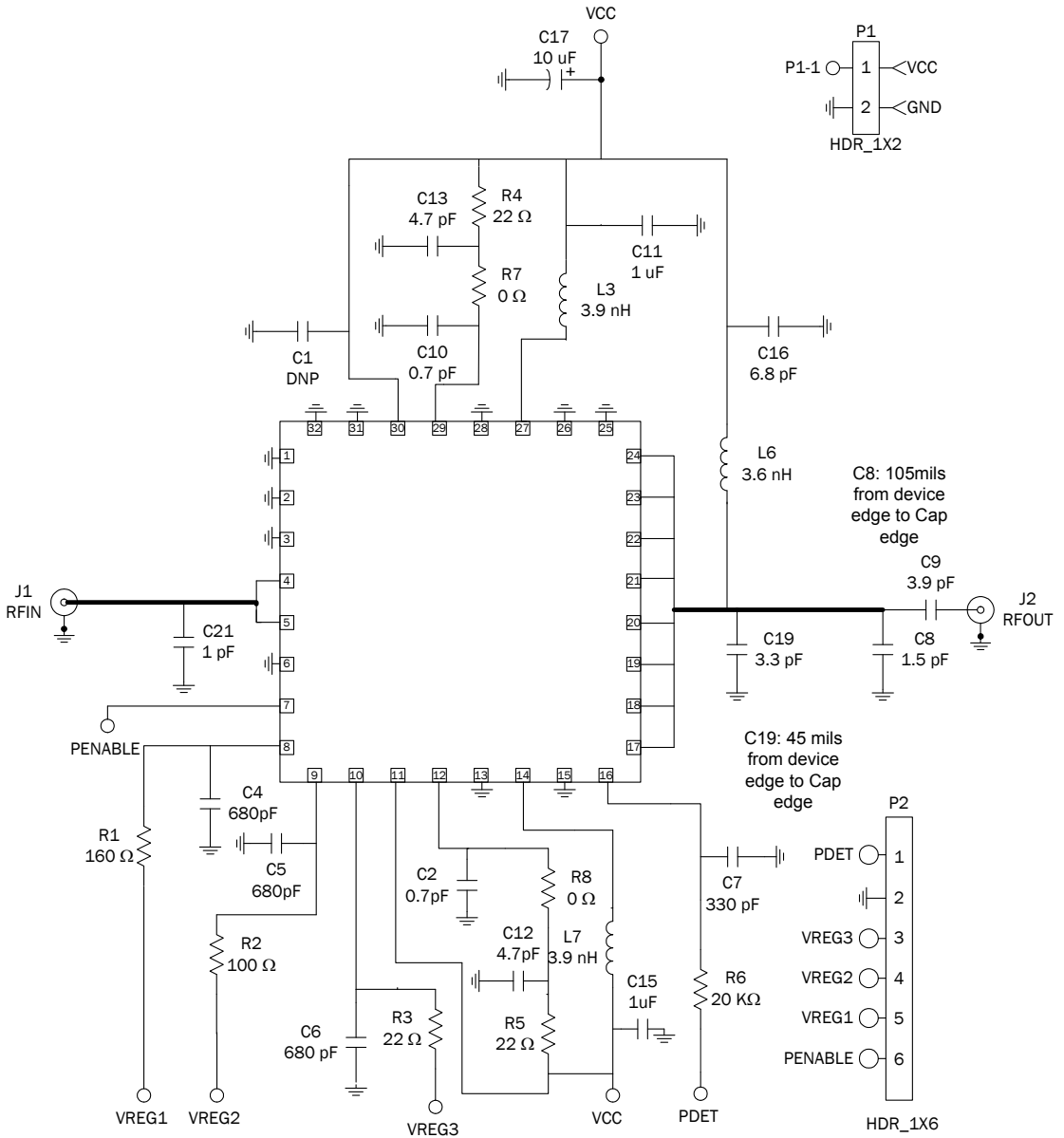

## WiMAX Evaluation Board BOM

| Description                            | Qty | Reference Designator        | Manufacturer                | Manufacturer's P/N |
|--|-----|-----------------------------|-----------------------------|--------------------|
| CAP, 10uF, 10%, 10V, X5R, 0805         | 1   | C17                         | Murata Electronics          | GRM21BR61A106KE19L |
| CAP, 6.8pF, 5%, 50V, C0G, 0402         | 1   | C16                         | Murata Electronics          | GJM1555C1H6R8CB01E |
| CAP, 680pF, 5%, 50V, C0G, 0402         | 2   | C5, C6                      | Murata Electronics          | GRM1555C1H681JZ01D |
| CAP, 330pF, 10%, 50V, X7R, 0402        | 1   | C7                          | Murata Electronics          | GRM155R71H331KA01E |
| CAP, 1uF, 10%, 10V, X5R, 0402          | 2   | C11, C15                    | Murata Electronics          | GRM155R61A105KE15D |
| CAP, 4.7pF, +/-0.25pF, 50V, HI-Q, 0402 | 2   | C12, C13                    | Murata Electronics          | GJM1555C1H4R7CB01E |
| CAP, 0.7pF, +/-0.25pF, 50V, HI-Q, 0402 | 2   | C2, C10                     | Murata Electronics          | GRM1555C1HR70BZ01D |
| CAP, 1.5pF, +/-0.25pF, 50V, HI-Q, 0402 | 1   | C8 - 105mils from QFN edge  | Murata Electronics          | GJM1555C1H1R5CB01E |
| CAP, 3.3pF, +/-0.1pF, 50V, HI-Q, 0402  | 1   | C19 - 45mils from QFN edge  | Murata Electronics          | GRM1555C1H3R3BZ01E |
| CAP, 3.9pF, +/-0.25pF, 50V, HI-Q, 0402 | 1   | C9                          | Murata Electronics          | GRM1555C1H3R9CZ01E |
| CAP, 1.0pF, +/-0.25pF, 50V, HI-Q, 0402 | 1   | C21 - 165mils from QFN edge | Murata Electronics          | GJM1555C1H1R0CB01E |
| RES, 160 OHM, 5%, 1/16W, 0402          | 1   | R1                          | Kamaya, Inc                 | RMC1/16S-161JTH    |
| RES, 100 OHM, 5%, 1/16W, 0402          | 1   | R2                          | Kamaya, Inc                 | RMC1/16S-101JTH    |
| RES, 22 OHM, 5%, 1/16W, 0402           | 3   | R3, R4, R5                  | Kamaya, Inc                 | RMC1/16S-220JTH    |
| RES, 20 KOHM, 5%, 1/16W, 0402          | 1   | R6                          | KOA Speer Electronics, Inc. | RK73H1ETP2002F     |
| IND, 3.9nH, 5%, WWW, 0603              | 1   | L6                          | Coilcraft                   | 0603HC-3N9XJLW     |
| RES, 0 OHM, 0402                       | 2   | R7, R8                      | Kamaya, Inc                 | RMC1/16SJPTH       |
| IND, 3.9nH, +/-0.3nH, ML, 0402         | 2   | L3, L7                      | Murata Electronics          | LQP15MN3N9B02D     |
| DNI                                    | 4   | C1, C3, C4, C14             |                             |                    |
| RF5652 5x5mm, QFN32                    | 1   | U1                          | RFMD                        |                    |

**RF5652 WLAN Evaluation Board Top Layer**

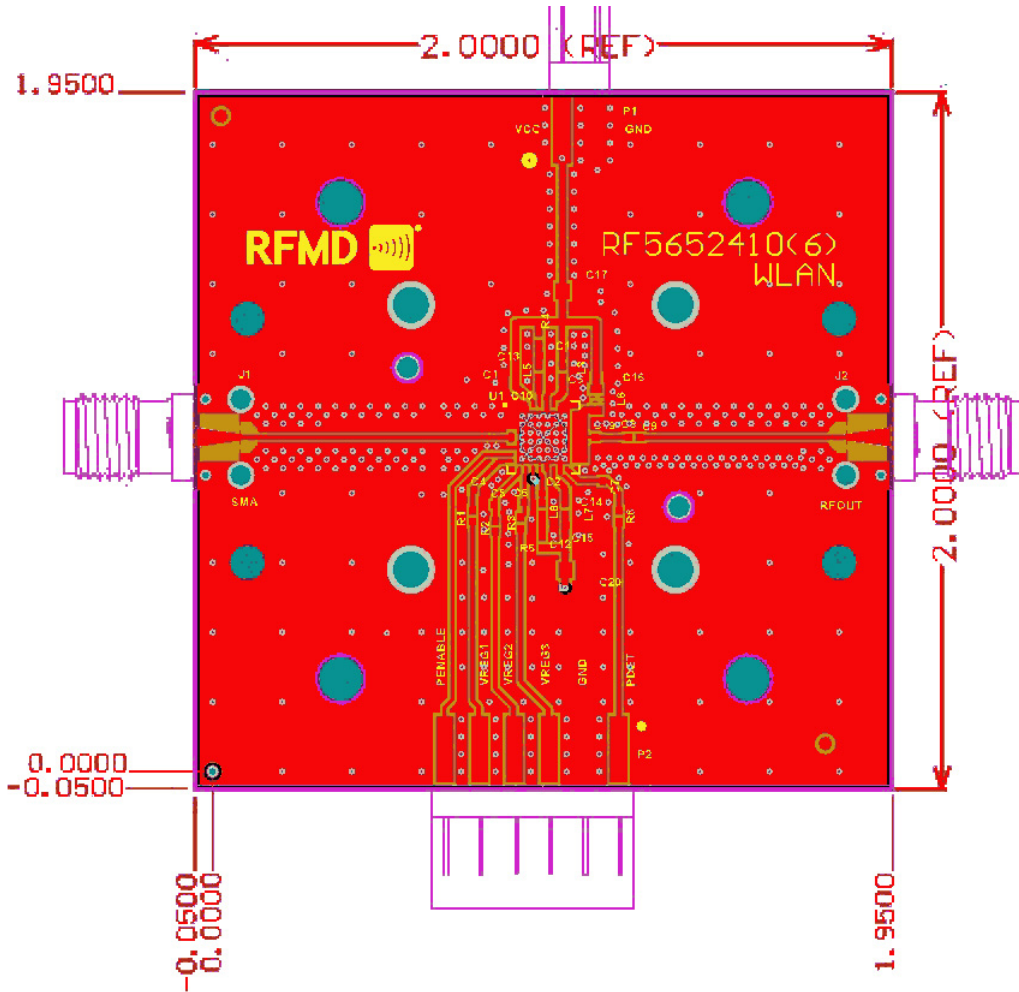

## RF5652 WLAN Evaluation Board Bottom Layer

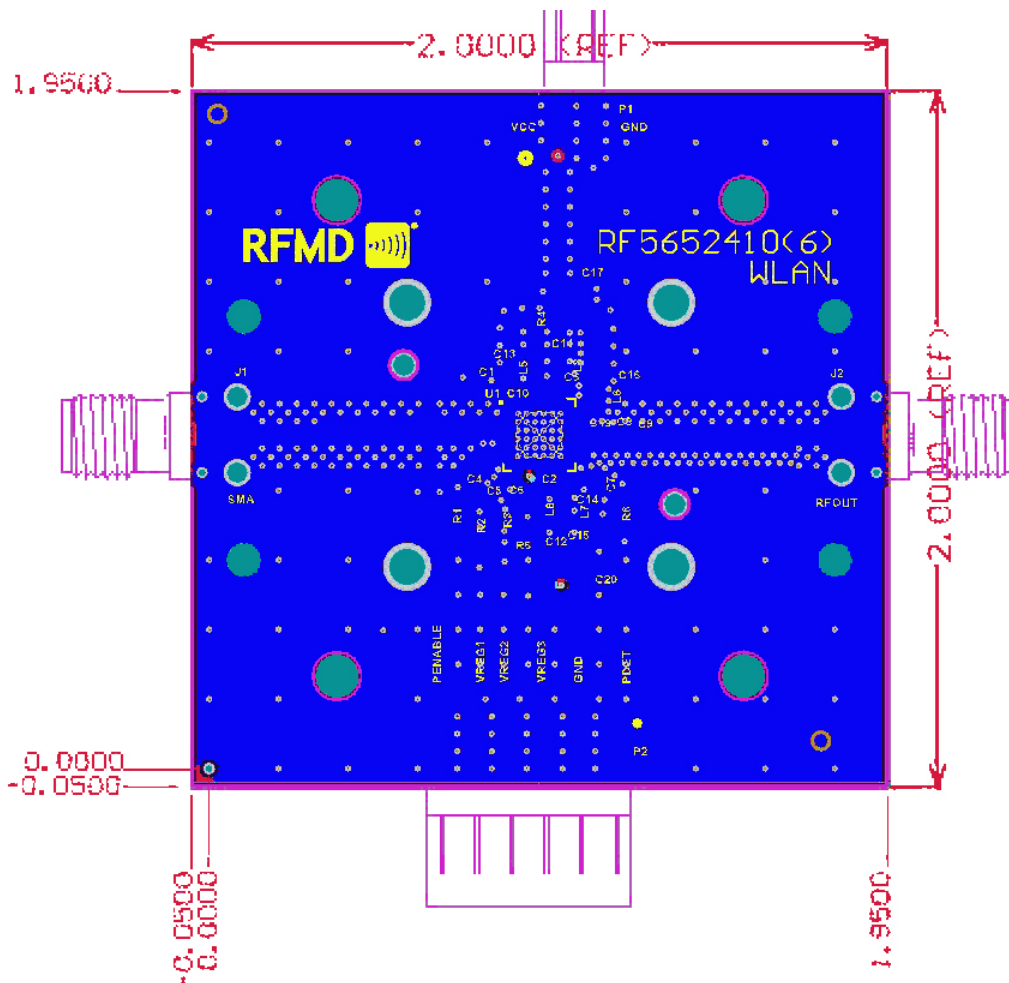

**WiFi 802.11n Performance Plots in 100% Duty Cycle**

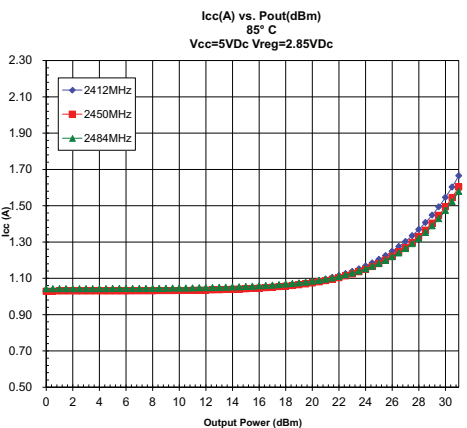
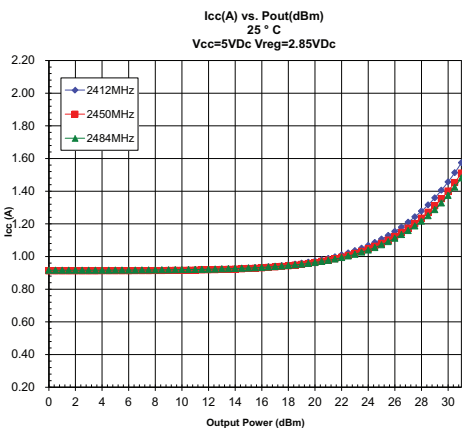
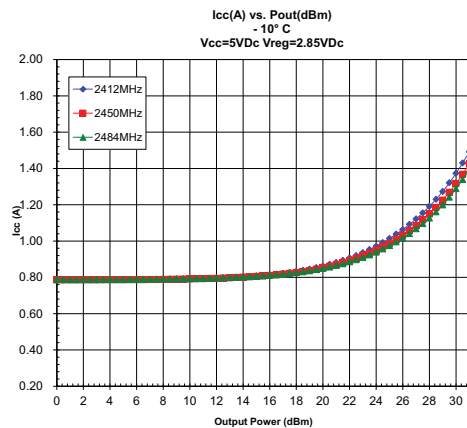
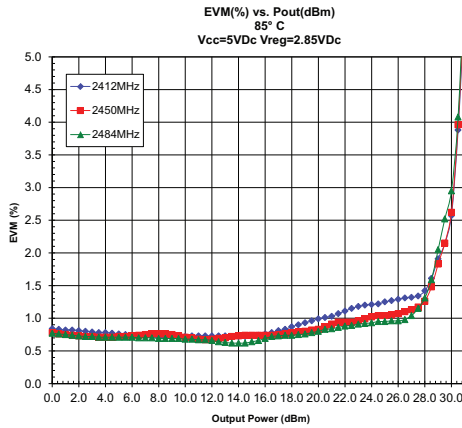
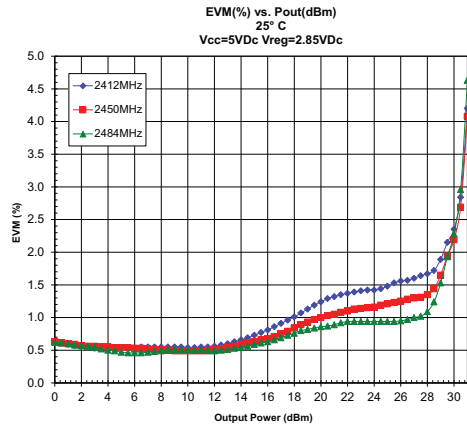
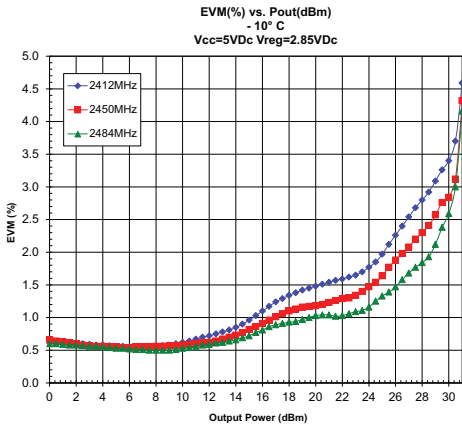

## WiFi 802.11n Performance Plots in 100% Duty Cycle

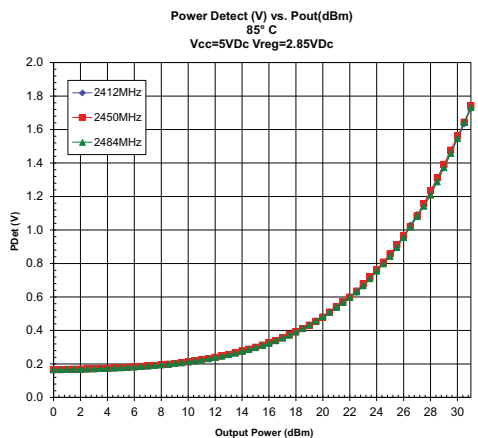
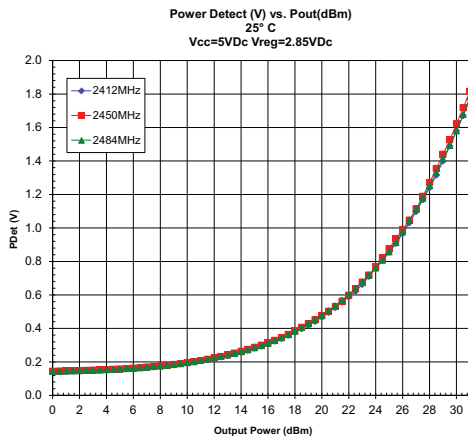
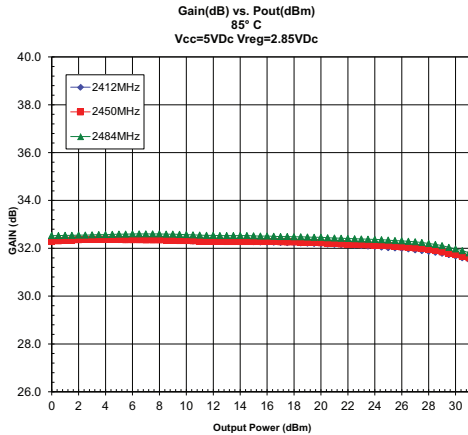
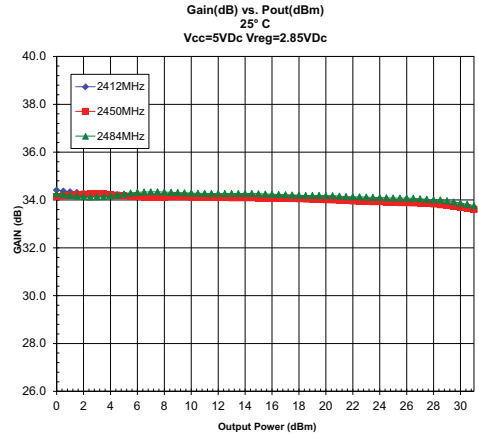
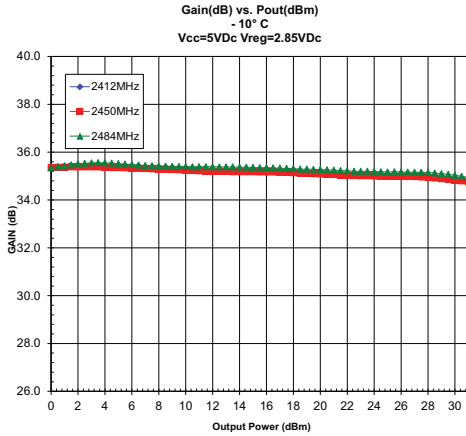



**WiFi 802.11n Performance Plots in 50% Duty Cycle**

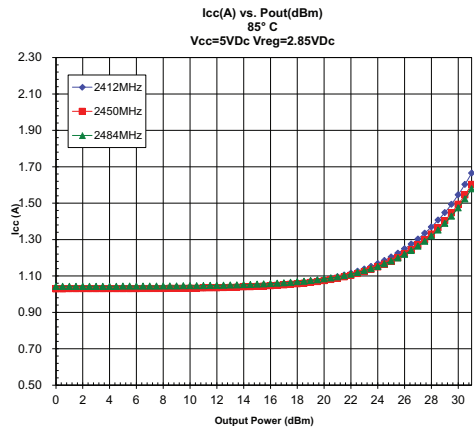
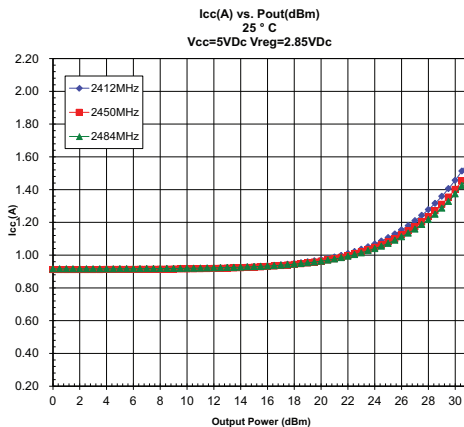
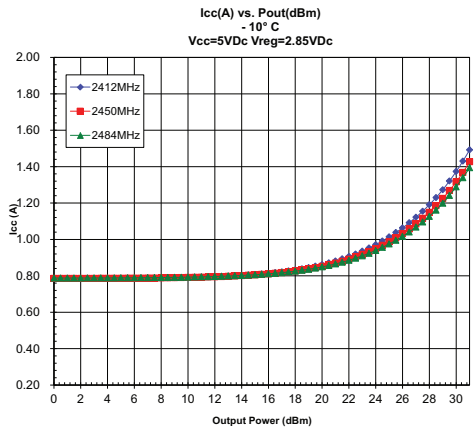
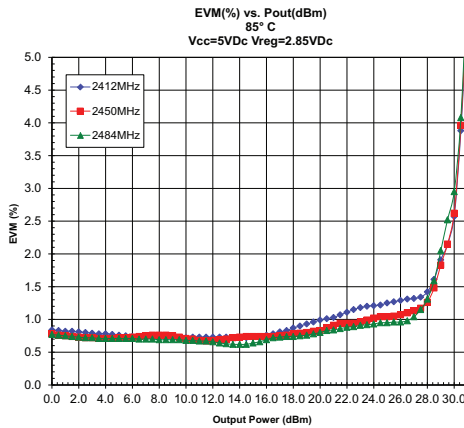
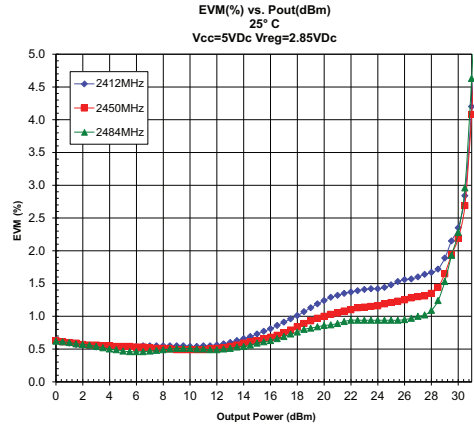
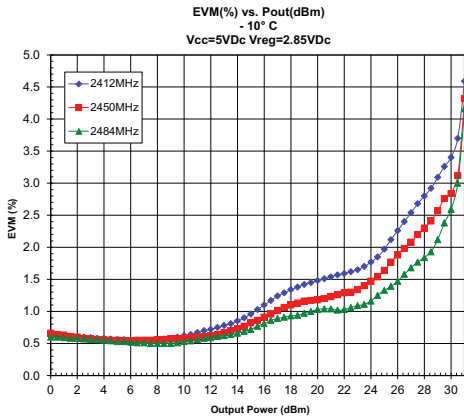

## WiFi 802.11n Performance Plots in 50% Duty Cycle

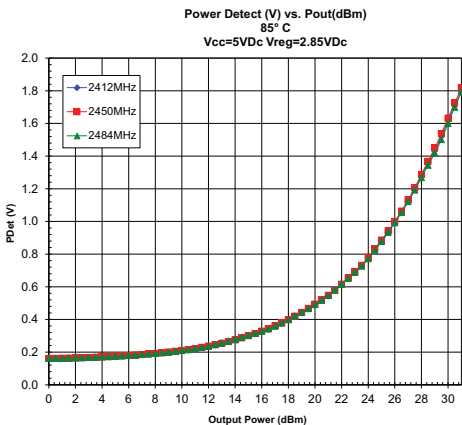
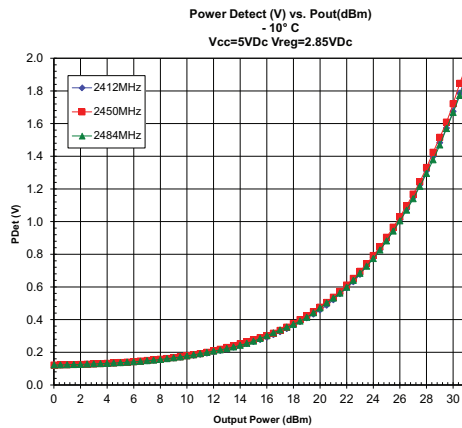
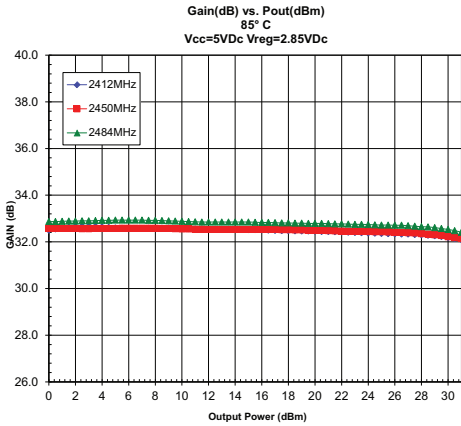
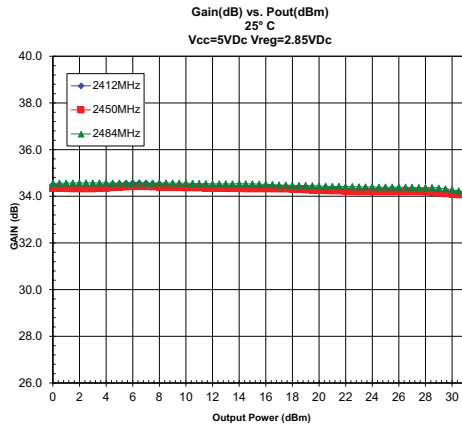
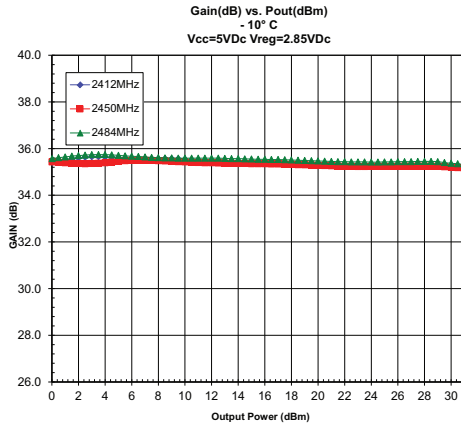

**WiFi 802.11g Performance Plots in 100% Duty Cycle**

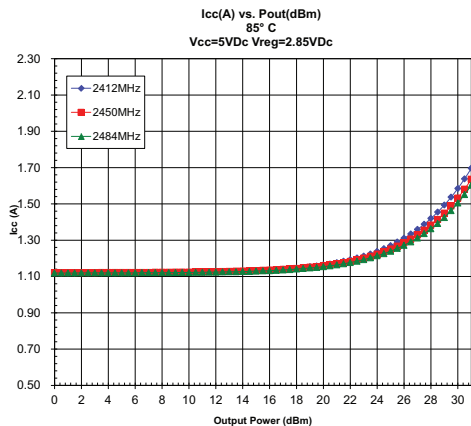
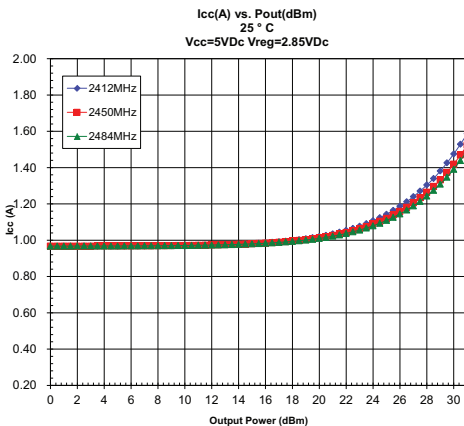
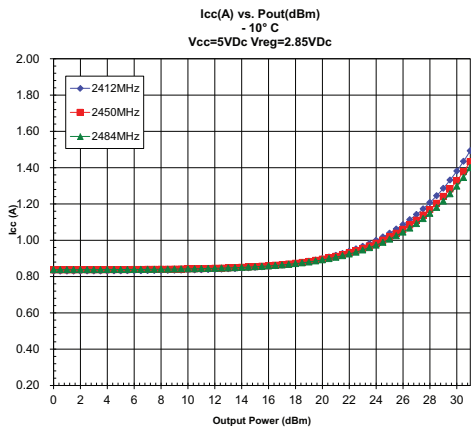
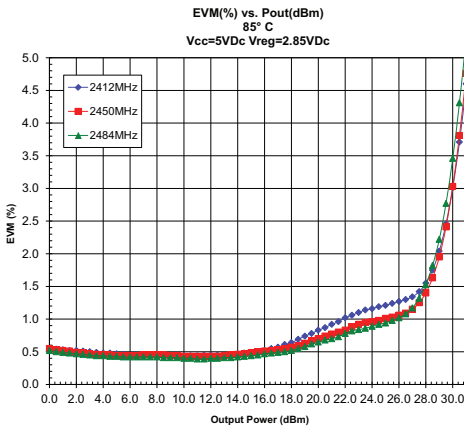
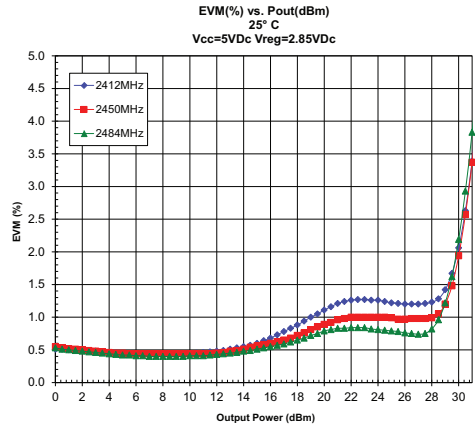
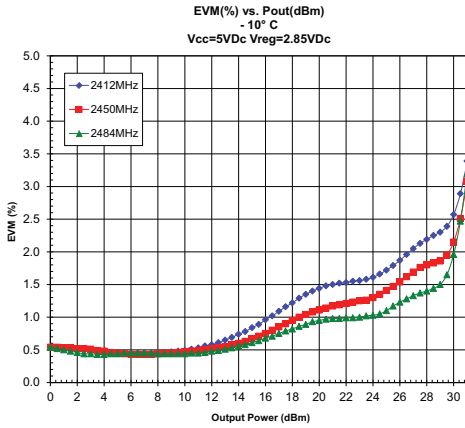

## WiFi 802.11g Performance Plots in 100% Duty Cycle

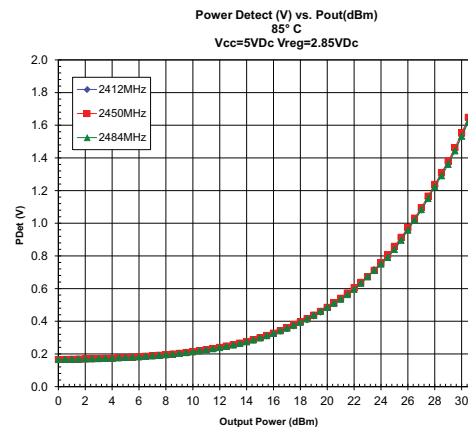
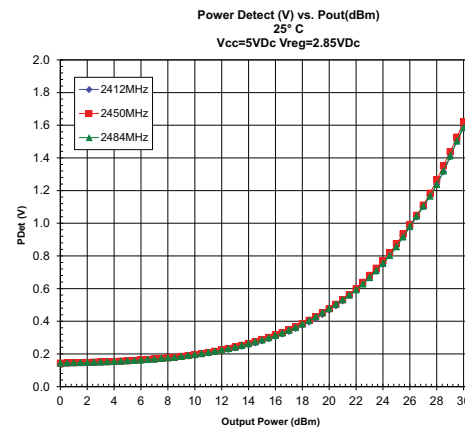
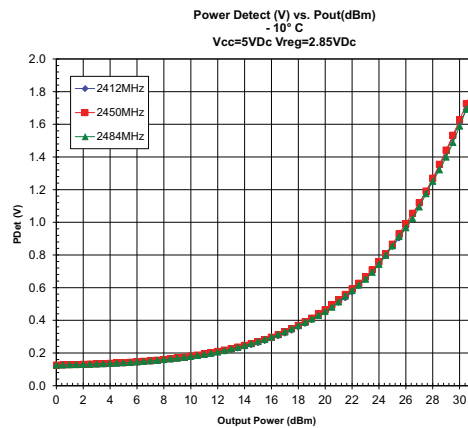
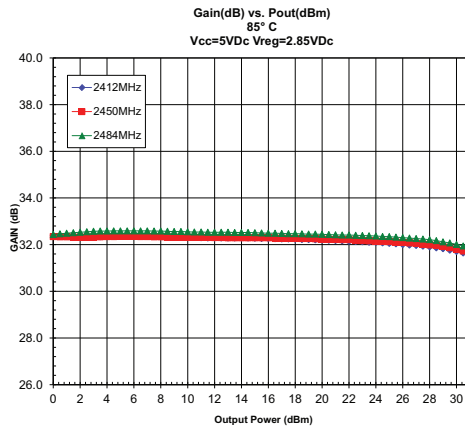
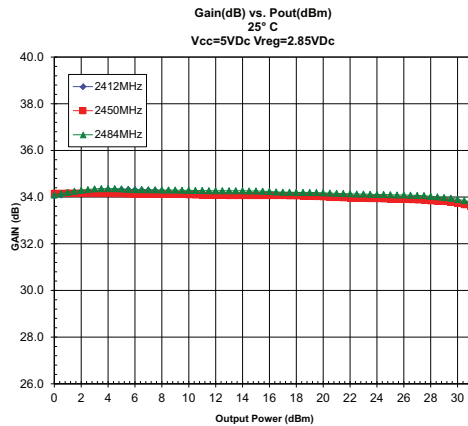
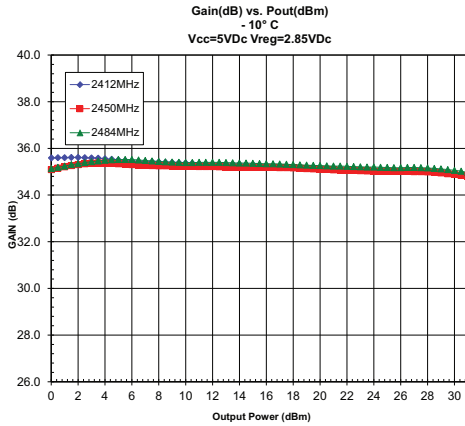

**WiMAX Performance Plots**

