

Standard Power MOSFET

IXTH / IXTM 5N100
IXTH / IXTM 5N100A

V_{DSS}	I_{D25}	$R_{DS(on)}$
1000 V	5 A	2.4 Ω
1000 V	5 A	2.0 Ω

N-Channel Enhancement Mode



Symbol	Test Conditions	Maximum Ratings	
V_{DSS}	$T_J = 25^\circ\text{C}$ to 150°C	1000	V
V_{DGR}	$T_J = 25^\circ\text{C}$ to 150°C ; $R_{GS} = 1\text{ M}\Omega$	1000	V
V_{GS}	Continuous	± 20	V
V_{GSM}	Transient	± 30	V
I_{D25}	$T_C = 25^\circ\text{C}$	5	A
I_{DM}	$T_C = 25^\circ\text{C}$, pulse width limited by T_{JM}	20	A
P_D	$T_C = 25^\circ\text{C}$	180	W
T_J		-55 ... +150	$^\circ\text{C}$
T_{JM}		150	$^\circ\text{C}$
T_{stg}		-55 ... +150	$^\circ\text{C}$
M_d	Mounting torque	1.13/10	Nm/lb.in.
Weight		TO-204 = 18 g, TO-247 = 6 g	
Maximum lead temperature for soldering 1.6 mm (0.062 in.) from case for 10 s		300	$^\circ\text{C}$

TO-247 AD (IXTH)

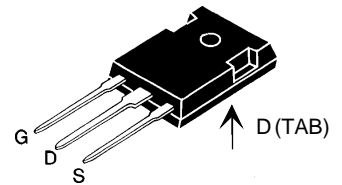

TO-204 AA (IXTM)

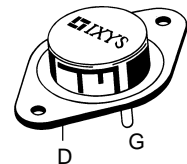

G = Gate, D = Drain,
S = Source, TAB = Drain

Features

- International standard packages
- Low $R_{DS(on)}$ HDMOS™ process
- Rugged polysilicon gate cell structure
- Low package inductance (< 5 nH)
 - easy to drive and to protect
- Fast switching times

Applications

- Switch-mode and resonant-mode power supplies
- Motor controls
- Uninterruptible Power Supplies (UPS)
- DC choppers

Advantages

- Easy to mount with 1 screw (TO-247) (isolated mounting screw hole)
- Space savings
- High power density

Symbol	Test Conditions	Characteristic Values ($T_J = 25^\circ\text{C}$, unless otherwise specified)		
		min.	typ.	max.
V_{DSS}	$V_{GS} = 0\text{ V}$, $I_D = 3\text{ mA}$	1000		V
$V_{GS(th)}$	$V_{DS} = V_{GS}$, $I_D = 250\text{ }\mu\text{A}$	2		4.5 V
I_{GSS}	$V_{GS} = \pm 20\text{ V}_{DC}$, $V_{DS} = 0$			$\pm 100\text{ nA}$
I_{DSS}	$V_{DS} = 0.8 \cdot V_{DSS}$ $V_{GS} = 0\text{ V}$			250 μA 1 mA
$R_{DS(on)}$	$V_{GS} = 10\text{ V}$, $I_D = 0.5 I_{D25}$ Pulse test, $t \leq 300\text{ }\mu\text{s}$, duty cycle $d \leq 2\%$			2.4 Ω 2.0 Ω

Symbol	Test Conditions	Characteristic Values ($T_J = 25^\circ\text{C}$, unless otherwise specified)		
		min.	typ.	max.
g_{fs}	$V_{DS} = 10\text{ V}; I_D = 0.5 \cdot I_{D25}$, pulse test	4	6	S
C_{iss}	$V_{GS} = 0\text{ V}, V_{DS} = 25\text{ V}, f = 1\text{ MHz}$		2600	pF
C_{oss}			180	pF
C_{rss}			45	pF
$t_{d(on)}$	$V_{GS} = 10\text{ V}, V_{DS} = 0.5 \cdot V_{DSS}, I_D = 0.5 I_{D25}$ $R_G = 4.7\ \Omega$, (External)		35	100 ns
t_r			20	50 ns
$t_{d(off)}$			100	200 ns
t_f			30	80 ns
$Q_{g(on)}$	$V_{GS} = 10\text{ V}, V_{DS} = 0.5 \cdot V_{DSS}, I_D = 0.5 I_{D25}$		88	130 nC
Q_{gs}			21	30 nC
Q_{gd}			38	70 nC
R_{thJC}			0.7	K/W
R_{thCK}		0.25		K/W

Source-Drain Diode

Symbol	Test Conditions	Characteristic Values ($T_J = 25^\circ\text{C}$, unless otherwise specified)		
		min.	typ.	max.
I_S	$V_{GS} = 0\text{ V}$			5 A
I_{SM}	Repetitive; pulse width limited by T_{JM}			20 A
V_{SD}	$I_F = I_S, V_{GS} = 0\text{ V}$, Pulse test, $t \leq 300\ \mu\text{s}$, duty cycle $d \leq 2\%$			1.5 V
t_{rr}	$I_F = I_S, -di/dt = 100\text{ A}/\mu\text{s}, V_R = 100\text{ V}$	900		ns

TO-247 AD (IXTH) Outline

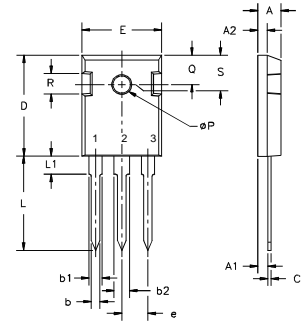

Terminals: 1 - Gate 2 - Drain
3 - Source Tab - Drain

Dim.	Millimeter		Inches	
	Min.	Max.	Min.	Max.
A	4.7	5.3	.185	.209
A ₁	2.2	2.54	.087	.102
A ₂	2.2	2.6	.059	.098
b	1.0	1.4	.040	.055
b ₁	1.65	2.13	.065	.084
b ₂	2.87	3.12	.113	.123
C	.4	.8	.016	.031
D	20.80	21.46	.819	.845
E	15.75	16.26	.610	.640
e	5.20	5.72	0.205	0.225
L	19.81	20.32	.780	.800
L1		4.50		.177
ØP	3.55	3.65	.140	.144
Q	5.89	6.40	0.232	0.252
R	4.32	5.49	.170	.216
S	6.15	BSC	242	BSC

TO-204AA (IXTM) Outline

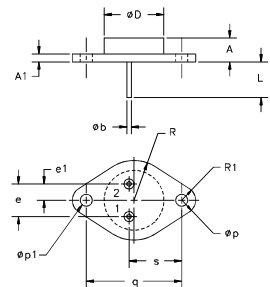

Pins 1 - Gate 2 - Source
Case - Drain

Dim.	Millimeter		Inches	
	Min.	Max.	Min.	Max.
A	6.4	11.4	.250	.450
A ₁		3.42		.135
Øb	.97	1.09	.038	.043
ØD		22.22		.875
e	10.67	11.17	.420	.440
e ₁	5.21	5.71	.205	.225
L	7.93		.312	
Øp	3.84	4.19	.151	.165
Øp ₁	3.84	4.19	.151	.165
q		30.15		1.187
R		13.33		.525
R ₁		4.77		.188
s	16.64	17.14	.655	.675

Fig. 1 Output Characteristics

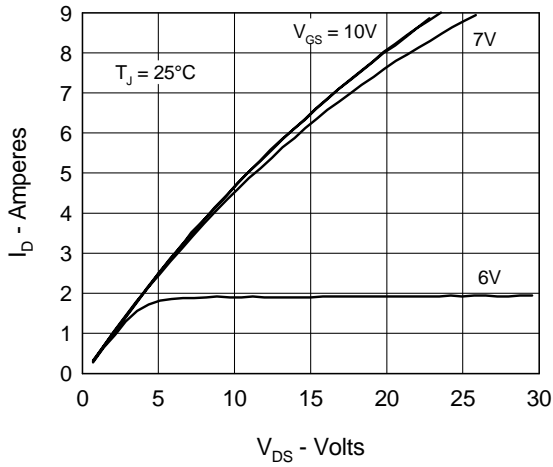

Fig. 2 Input Admittance

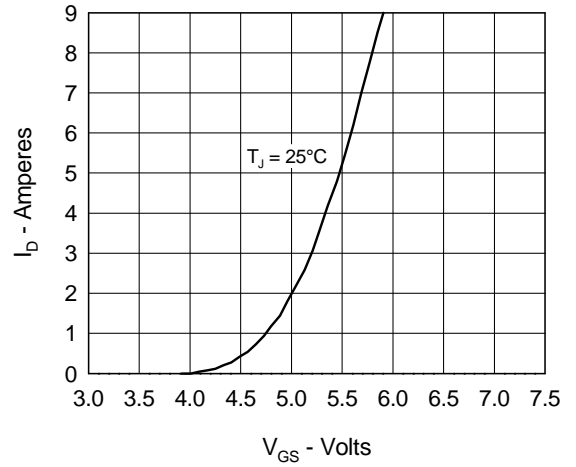

Fig. 3 $R_{DS(on)}$ vs. Drain Current

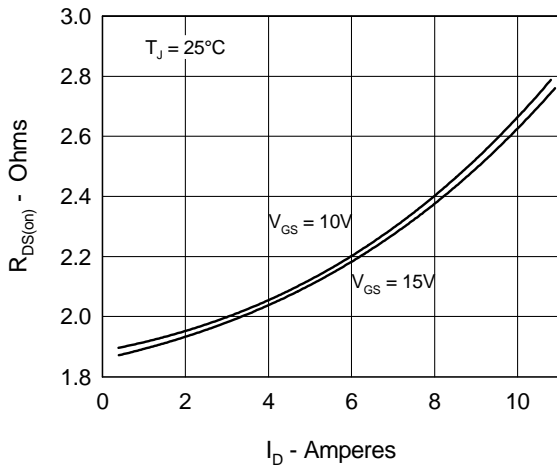

Fig. 4 Temperature Dependence of Drain to Source Resistance

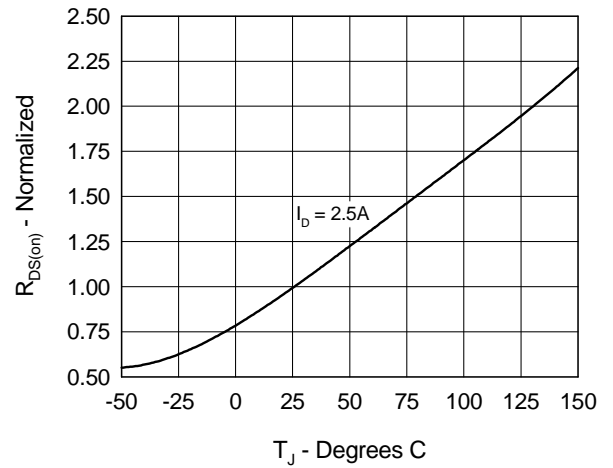

Fig. 5 Drain Current vs. Case Temperature

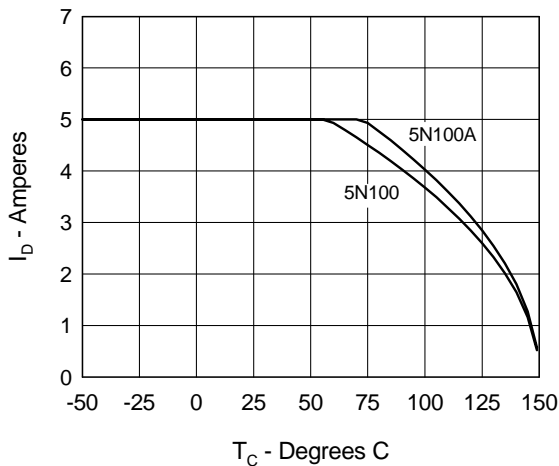

Fig. 6 Temperature Dependence of Breakdown and Threshold Voltage

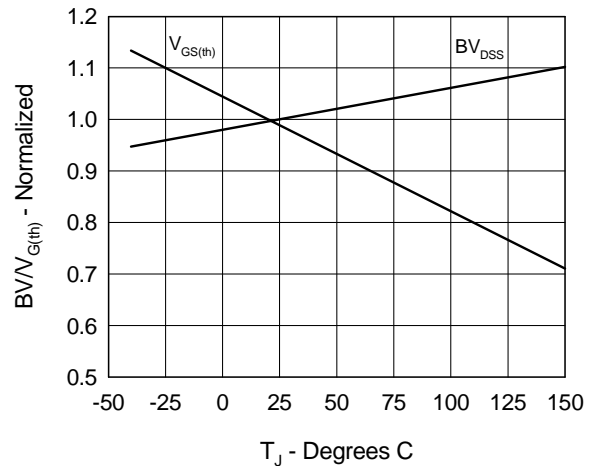

Fig.7 Gate Charge Characteristic Curve

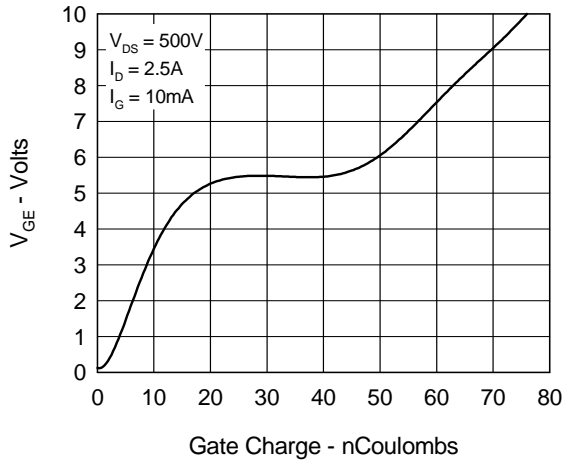

Fig.8 Forward Bias Safe Operating Area

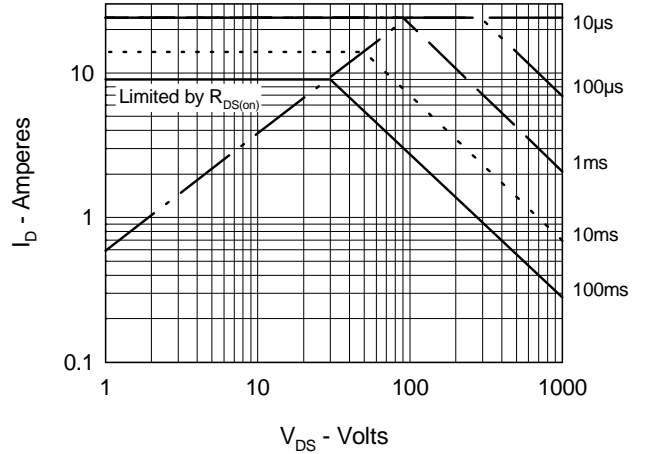

Fig.9 Capacitance Curves

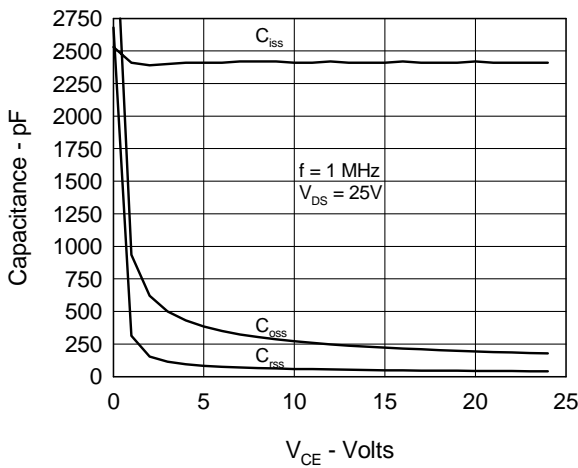

Fig.10 Source Current vs. Source to Drain Voltage

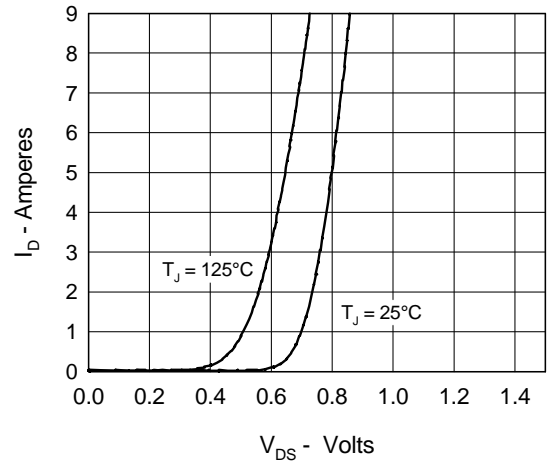

Fig.11 Transient Thermal Impedance

