

## Molded transformer terminal block - VTRK 4 OG - 3004595

Please be informed that the data shown in this PDF Document is generated from our Online Catalog. Please find the complete data in the user's documentation. Our General Terms of Use for Downloads are valid (<http://phoenixcontact.com/download>)



Molded transformer terminal block, Connection method: Screw connection, Length: 23.4 mm, Width: 12.4 mm, Height: 17.2 mm, Color: orange



### Key commercial data

Packing unit	1 pc
Weight per Piece (excluding packing)	7.42 GRM
Custom tariff number	85369010
Country of origin	Poland

### Technical data

#### General

Number of connections	4
Color	orange
Insulating material	PA
Inflammability class according to UL 94	V0
Rated surge voltage	4 kV
Rated insulation voltage	250 V
Pollution degree	3
Surge voltage category	III
Nominal current $I_N$	25 A
Nominal voltage $U_N$	voltage data only possible in conjunction with transformer
Number of positions	2

#### Dimensions

Width	12.4 mm
Length	23.4 mm
Height	17.2 mm

## Molded transformer terminal block - VTRK 4 OG - 3004595

### Technical data

#### Connection data

Conductor cross section solid min.	0.2 mm <sup>2</sup>
Conductor cross section solid max.	6 mm <sup>2</sup>
Conductor cross section stranded min.	0.2 mm <sup>2</sup>
Conductor cross section stranded max.	4 mm <sup>2</sup>
Conductor cross section AWG/kcmil min.	24
Conductor cross section AWG/kcmil max	10
Conductor cross section stranded, with ferrule without plastic sleeve min.	0.25 mm <sup>2</sup>
Conductor cross section stranded, with ferrule without plastic sleeve max.	4 mm <sup>2</sup>
Conductor cross section stranded, with ferrule with plastic sleeve min.	0.25 mm <sup>2</sup>
Conductor cross section stranded, with ferrule with plastic sleeve max.	2.5 mm <sup>2</sup>
2 conductors with same cross section, solid min.	0.2 mm <sup>2</sup>
2 conductors with same cross section, solid max.	1.5 mm <sup>2</sup>
2 conductors with same cross section, stranded min.	0.2 mm <sup>2</sup>
2 conductors with same cross section, stranded max.	1.5 mm <sup>2</sup>
2 conductors with same cross section, stranded, ferrules without plastic sleeve, min.	0.25 mm <sup>2</sup>
2 conductors with same cross section, stranded, ferrules without plastic sleeve, max.	1.5 mm <sup>2</sup>
2 conductors with same cross section, stranded, TWIN ferrules with plastic sleeve, min.	0.5 mm <sup>2</sup>
2 conductors with same cross section, stranded, TWIN ferrules with plastic sleeve, max.	2.5 mm <sup>2</sup>
Connection method	Screw connection
Stripping length	8 mm
Internal cylindrical gage	A4
Screw thread	M3
Tightening torque, min	0.6 Nm
Tightening torque max	0.8 Nm

### Classifications

#### eCl@ss

eCl@ss 4.0	27141110
eCl@ss 4.1	27141110
eCl@ss 5.0	27141110
eCl@ss 5.1	27141110
eCl@ss 6.0	27141110
eCl@ss 7.0	27141110

# Molded transformer terminal block - VTRK 4 OG - 3004595

## Classifications

### eCl@ss

eCl@ss 8.0	27141190
------------	----------

### ETIM

ETIM 2.0	EC001283
ETIM 3.0	EC001283
ETIM 4.0	EC000398
ETIM 5.0	EC000398

### UNSPSC

UNSPSC 6.01	30211811
UNSPSC 7.0901	39121410
UNSPSC 11	39121410
UNSPSC 12.01	39121410
UNSPSC 13.2	39121410

## Approvals

### Approvals

---

#### Approvals

CSA / UL Recognized / cUL Recognized / GOST / GOST / cULus Recognized

---

#### Ex Approvals

---

#### Approvals submitted

---

## Approval details

CSA 		B	D
	mm <sup>2</sup> /AWG/kcmil	24-10	24-10
	Nominal current I <sub>N</sub>	35 A	10 A
	Nominal voltage U <sub>N</sub>	150 V	300 V

# Molded transformer terminal block - VTRK 4 OG - 3004595

## Approvals

UL Recognized		
	B	C
mm <sup>2</sup> /AWG/kcmil	30-10	30-10
Nominal current I <sub>N</sub>	30 A	30 A
Nominal voltage U <sub>N</sub>	300 V	300 V

cUL Recognized		
	B	C
mm <sup>2</sup> /AWG/kcmil	30-10	30-10
Nominal current I <sub>N</sub>	30 A	30 A
Nominal voltage U <sub>N</sub>	300 V	300 V

GOST		
------	--	--

GOST		
------	--	--

cULus Recognized		
------------------	--	--

## Drawings

# Molded transformer terminal block - VTRK 4 OG - 3004595

Dimensioned drawing

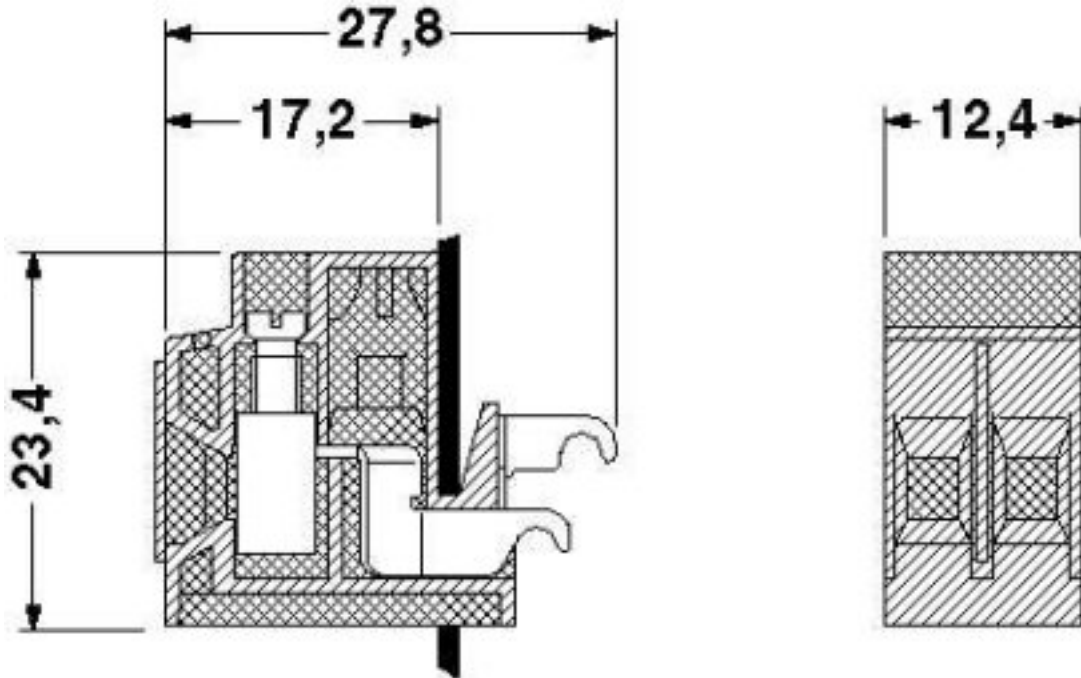

Dimensioned drawing

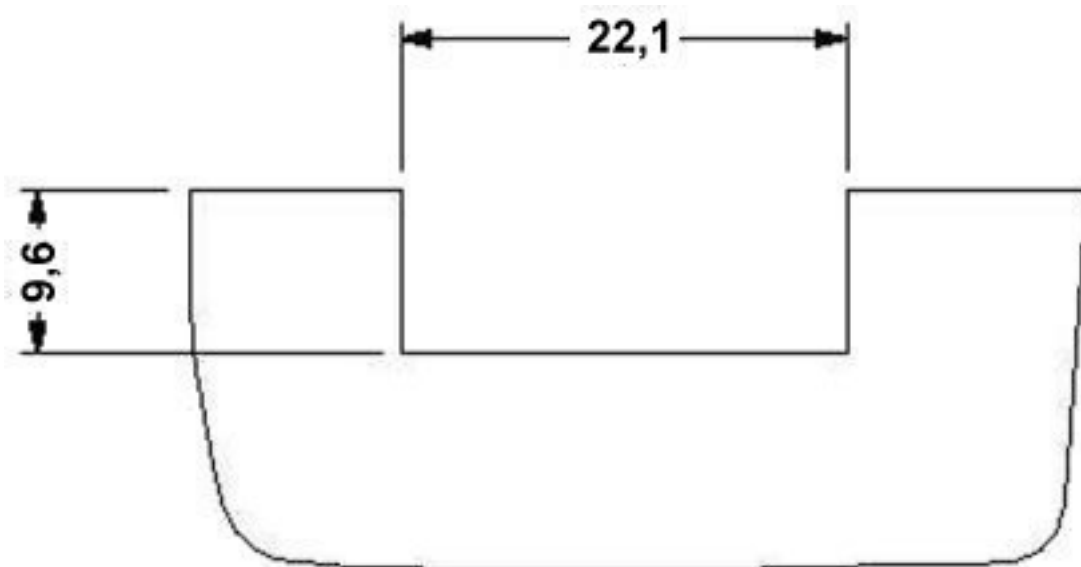

Housing cutout (panel thickness 1.8) for two transformer terminal blocks

## Molded transformer terminal block - VTRK 4 OG - 3004595

Dimensioned drawing

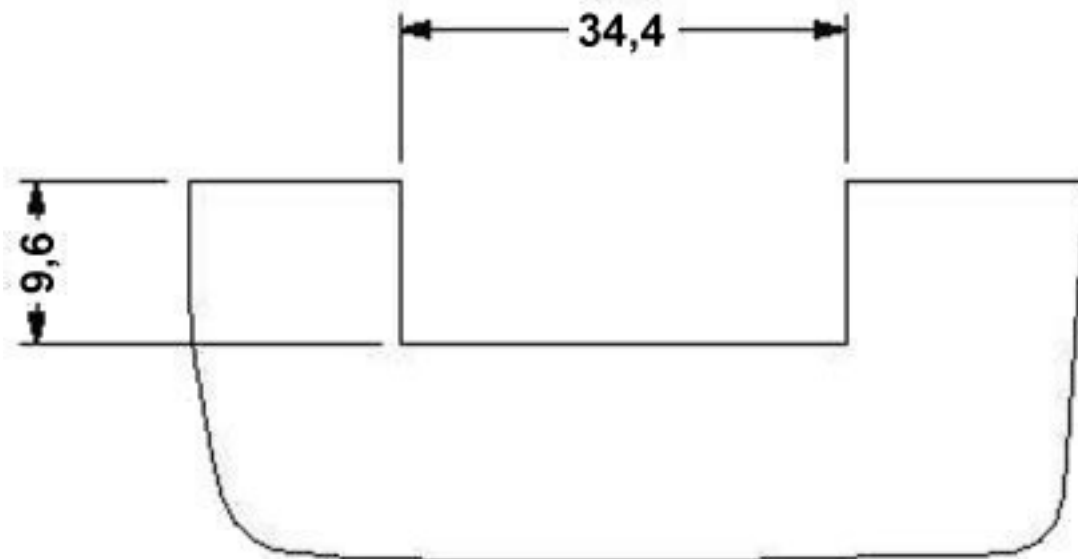

Housing cutout (panel thickness 1.8) for three transformer terminal blocks

Dimensioned drawing

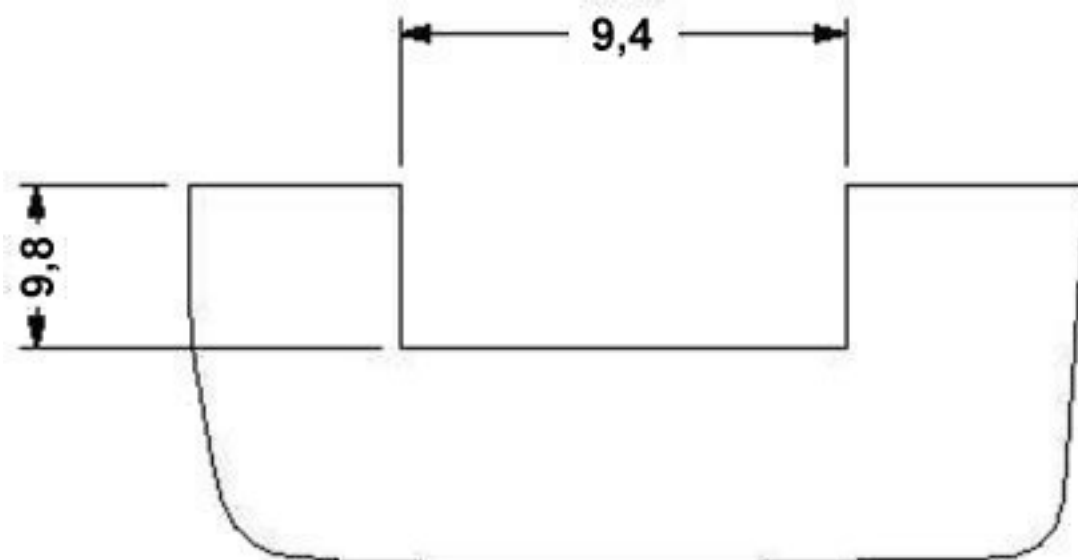

Housing cutout (panel thickness 1.9) for one transformer terminal block

## Molded transformer terminal block - VTRK 4 OG - 3004595

Dimensioned drawing

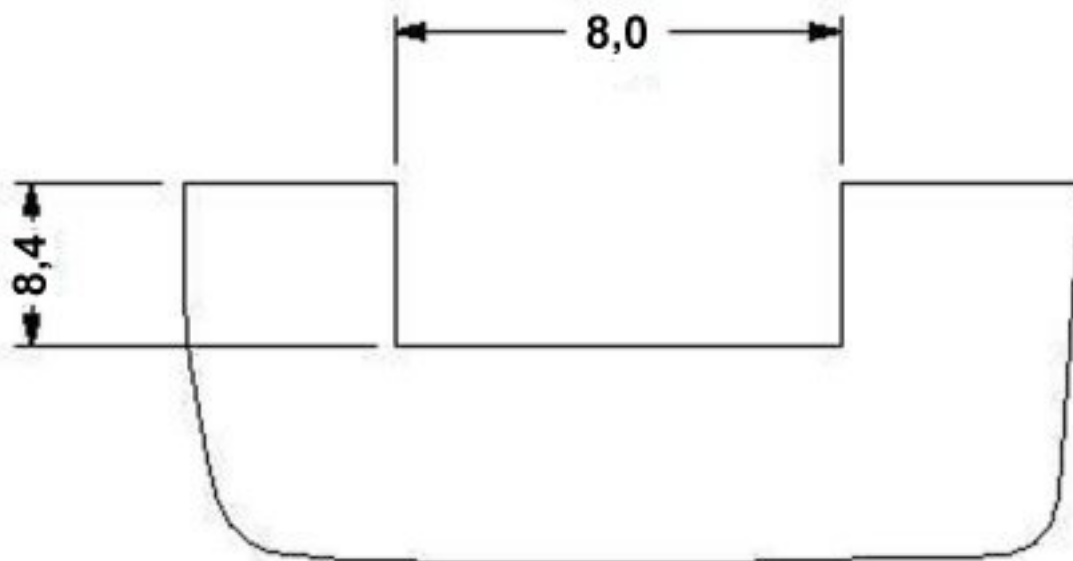

Housing cutout (panel thickness 1.2) for one transformer terminal block

Dimensioned drawing

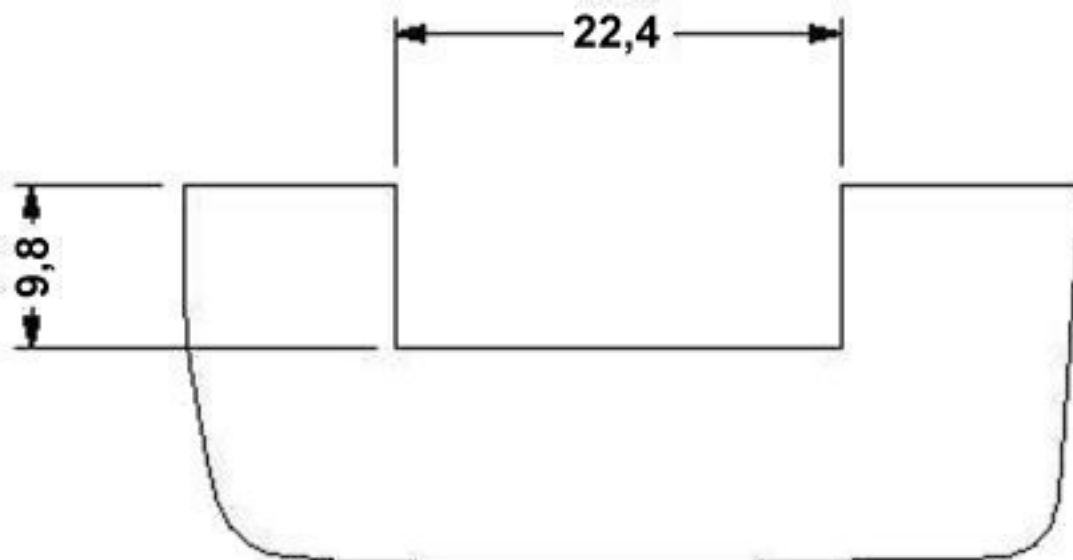

Housing cutout (panel thickness 1.9) for two transformer terminal blocks

## Molded transformer terminal block - VTRK 4 OG - 3004595

Dimensioned drawing

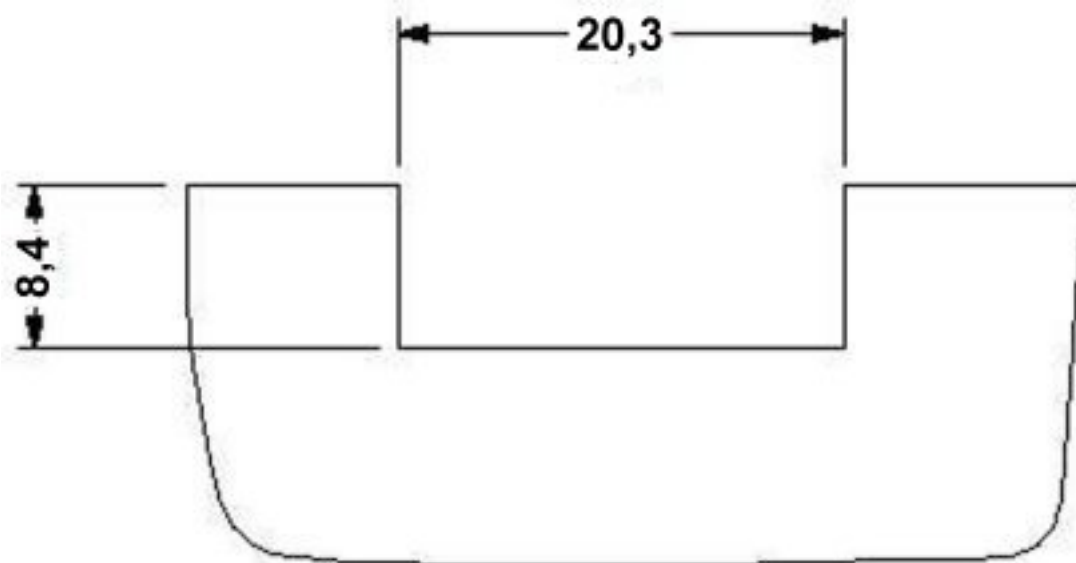

Housing cutout (panel thickness 1.2) for two transformer terminal blocks

Dimensioned drawing

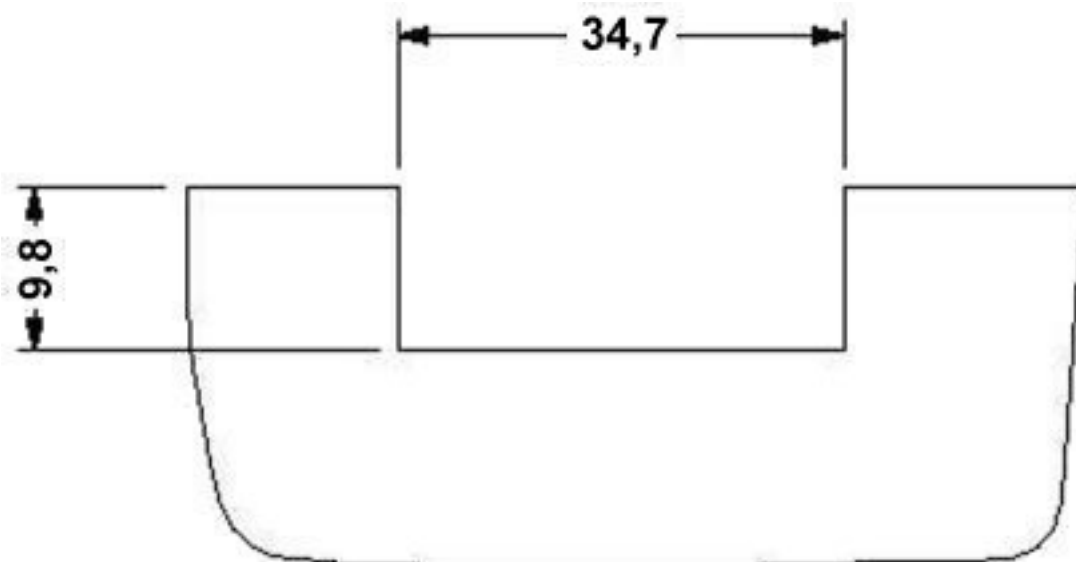

Housing cutout (panel thickness 1.9) for three transformer terminal blocks



## Molded transformer terminal block - VTRK 4 OG - 3004595

Dimensioned drawing

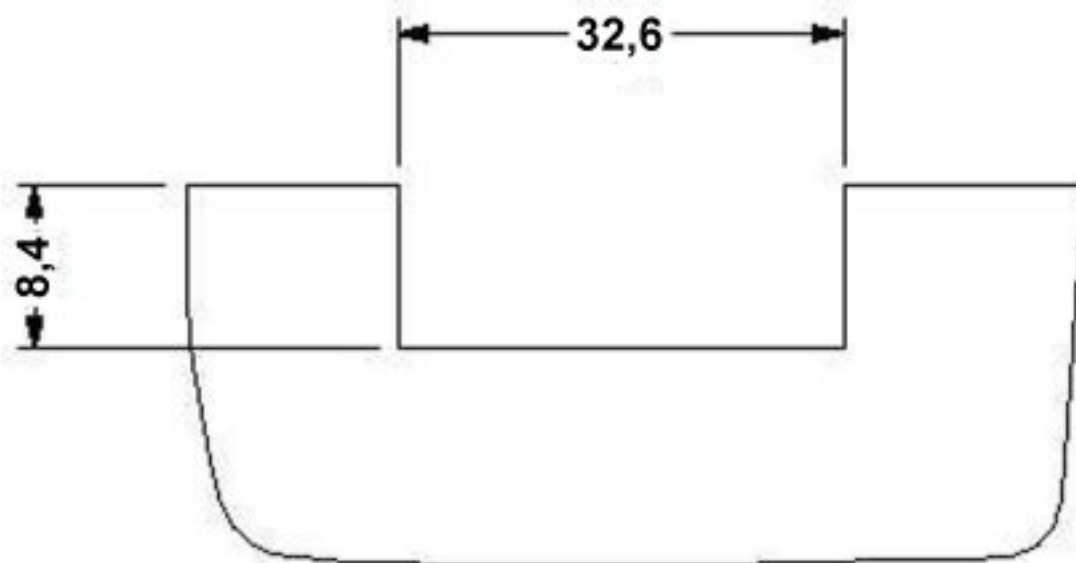

Housing cutout (panel thickness 1.2) for three transformer terminal blocks

Dimensioned drawing

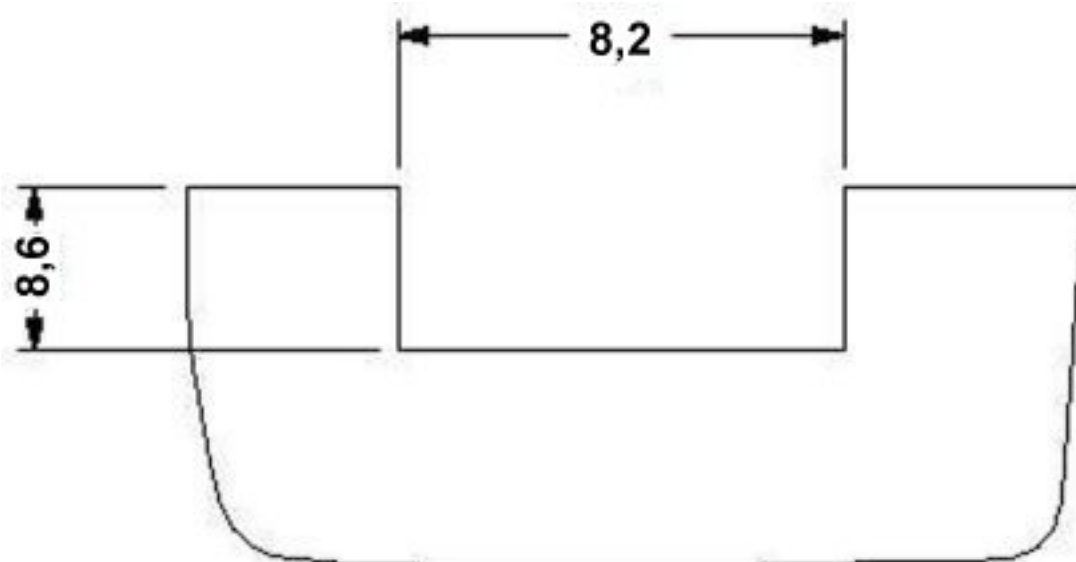

Housing cutout (panel thickness 1.3) for one transformer terminal block

## Molded transformer terminal block - VTRK 4 OG - 3004595

Dimensioned drawing

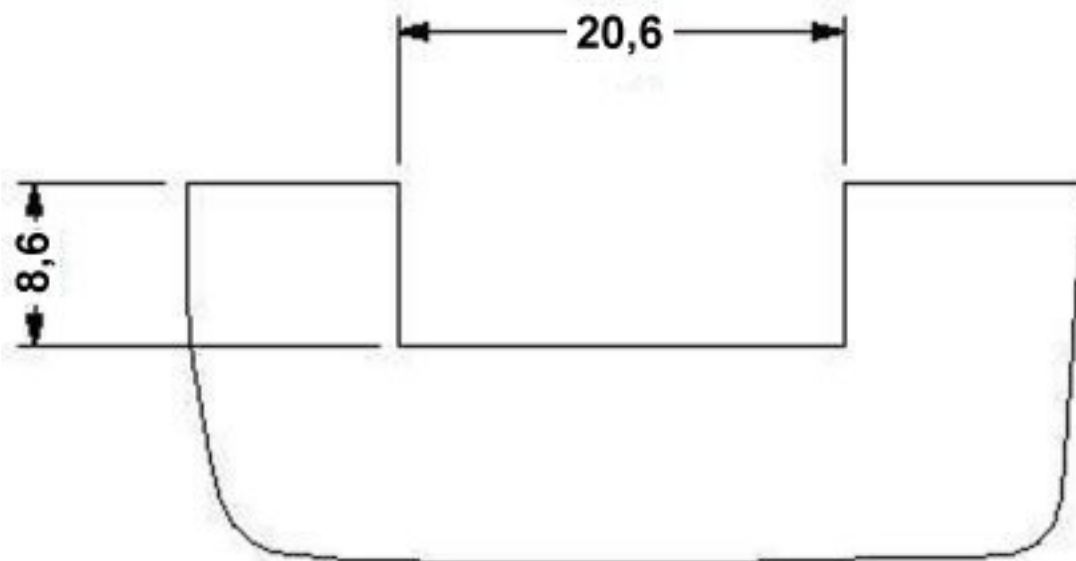

Housing cutout (panel thickness 1.3) for two transformer terminal blocks

Dimensioned drawing

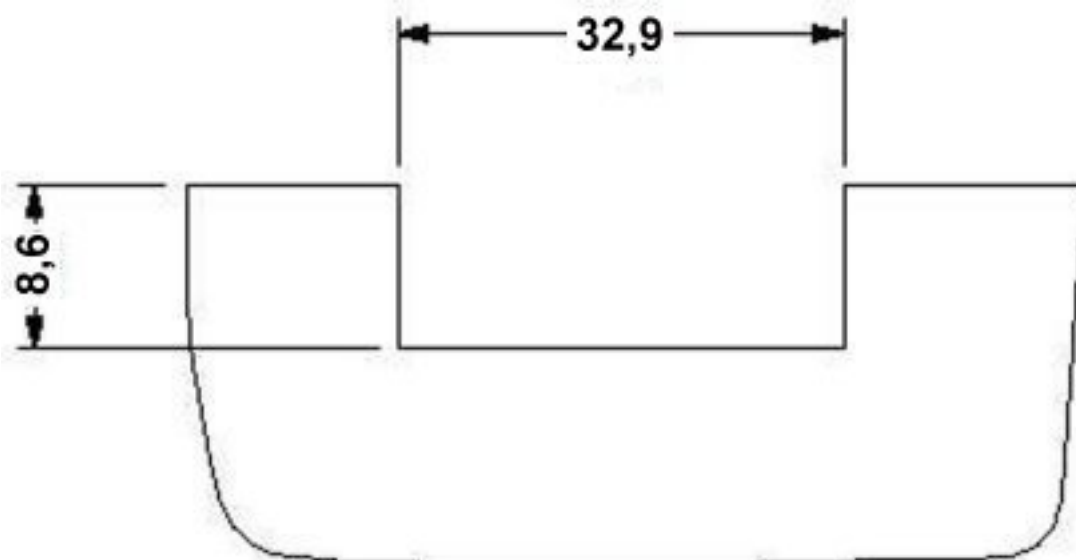

Housing cutout (panel thickness 1.3) for three transformer terminal blocks

## Molded transformer terminal block - VTRK 4 OG - 3004595

Dimensioned drawing

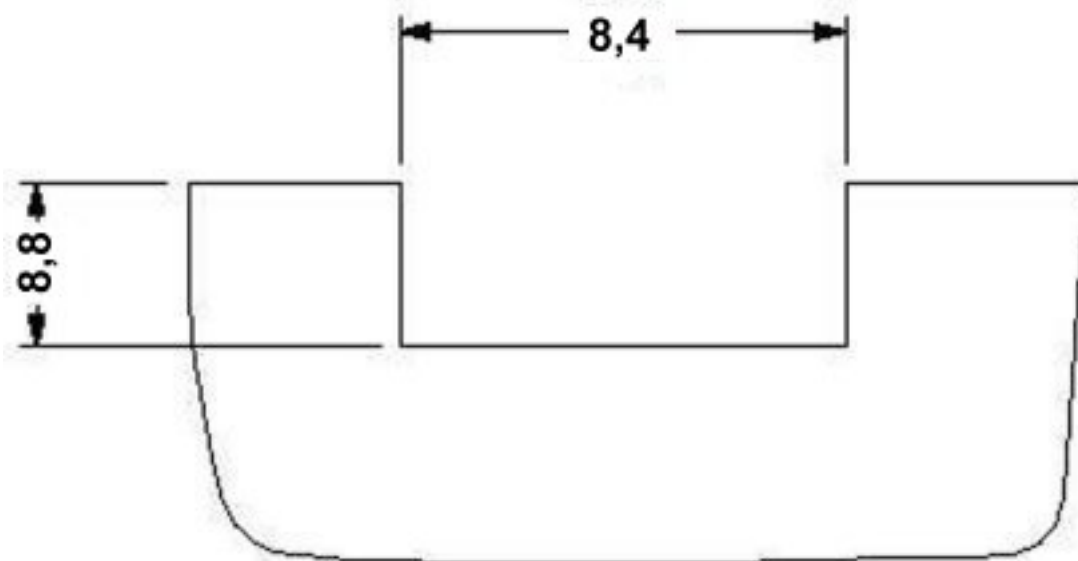

Housing cutout (panel thickness 1.4) for one transformer terminal block

Dimensioned drawing

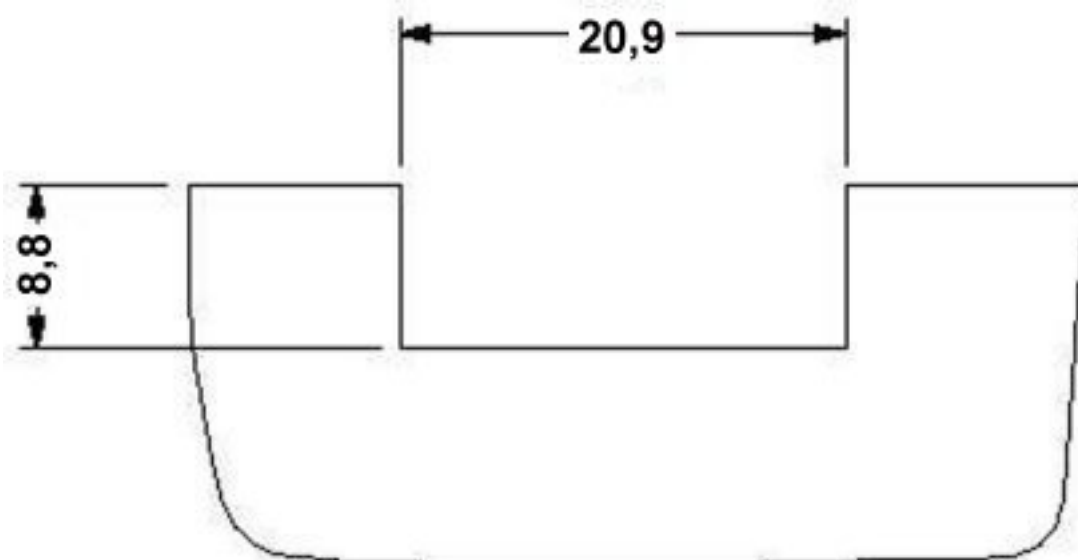

Housing cutout (panel thickness 1.4) for two transformer terminal blocks

## Molded transformer terminal block - VTRK 4 OG - 3004595

Dimensioned drawing

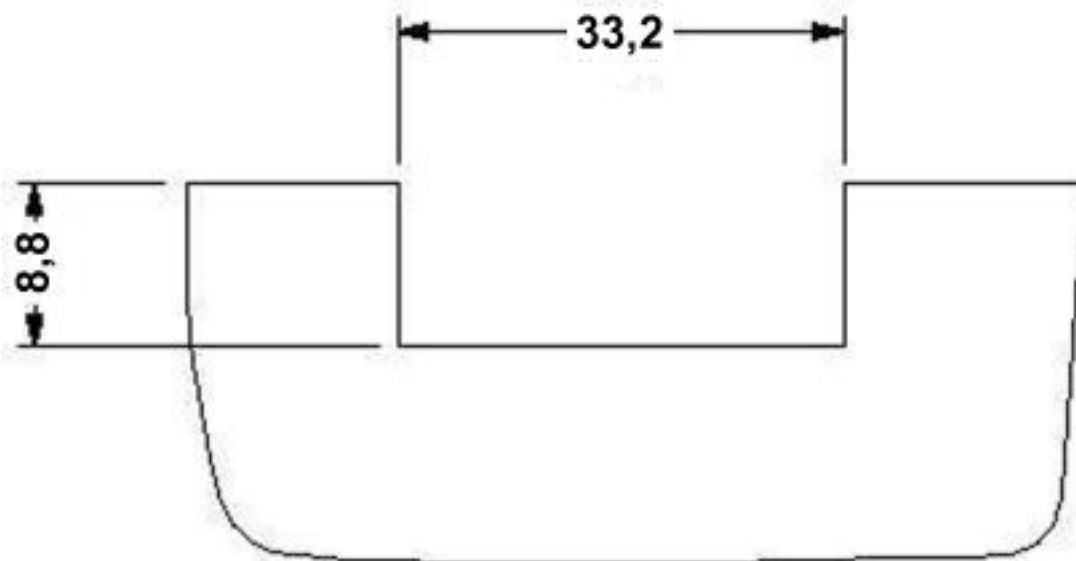

Housing cutout (panel thickness 1.4) for three transformer terminal blocks

Dimensioned drawing

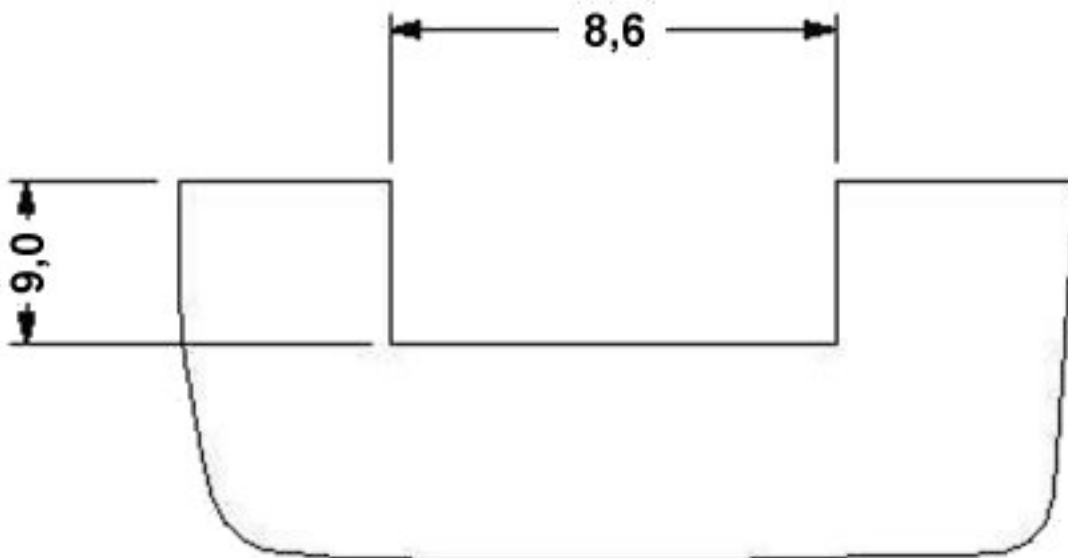

Housing cutout (panel thickness 1.5) for one transformer terminal block

## Molded transformer terminal block - VTRK 4 OG - 3004595

Dimensioned drawing

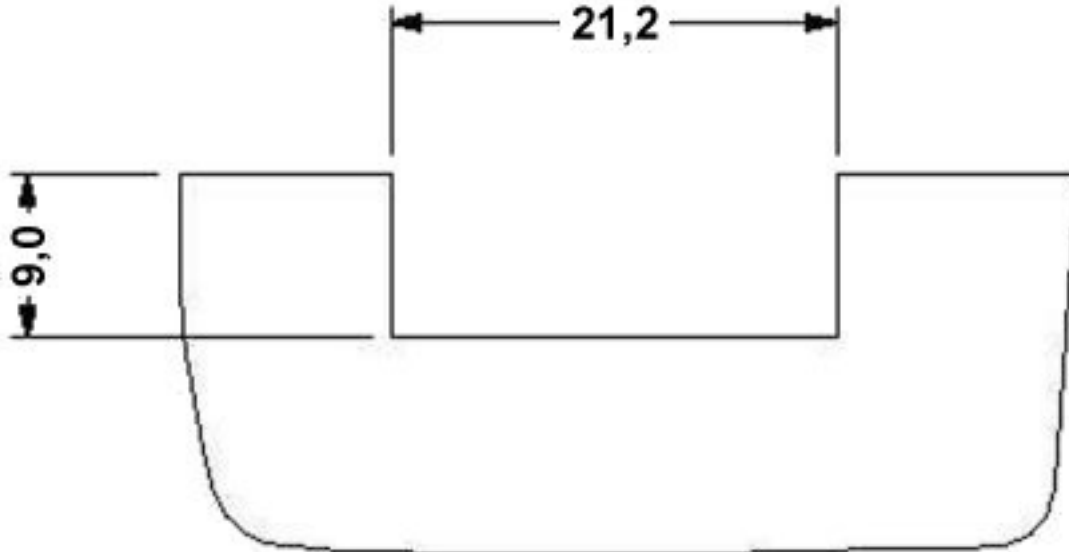

Housing cutout (panel thickness 1.5) for two transformer terminal blocks

Dimensioned drawing

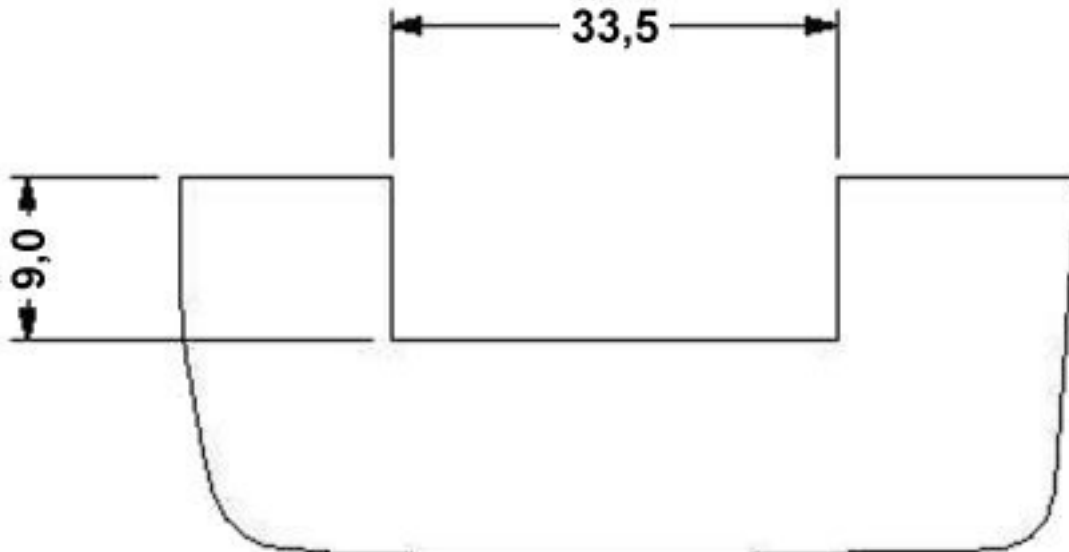

Housing cutout (panel thickness 1.5) for three transformer terminal blocks

## Molded transformer terminal block - VTRK 4 OG - 3004595

Dimensioned drawing

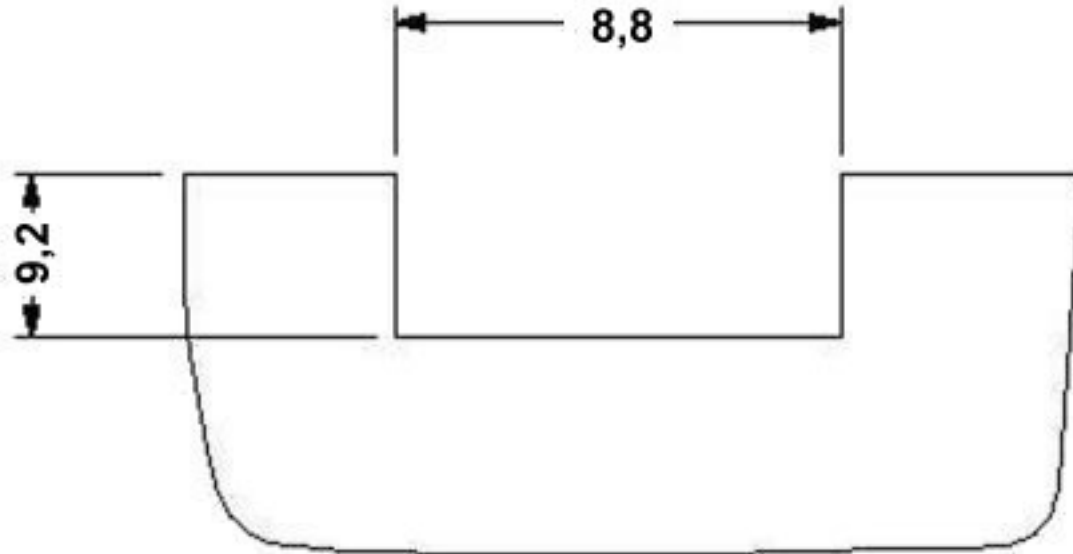

Housing cutout (panel thickness 1.6) for one transformer terminal block

Dimensioned drawing

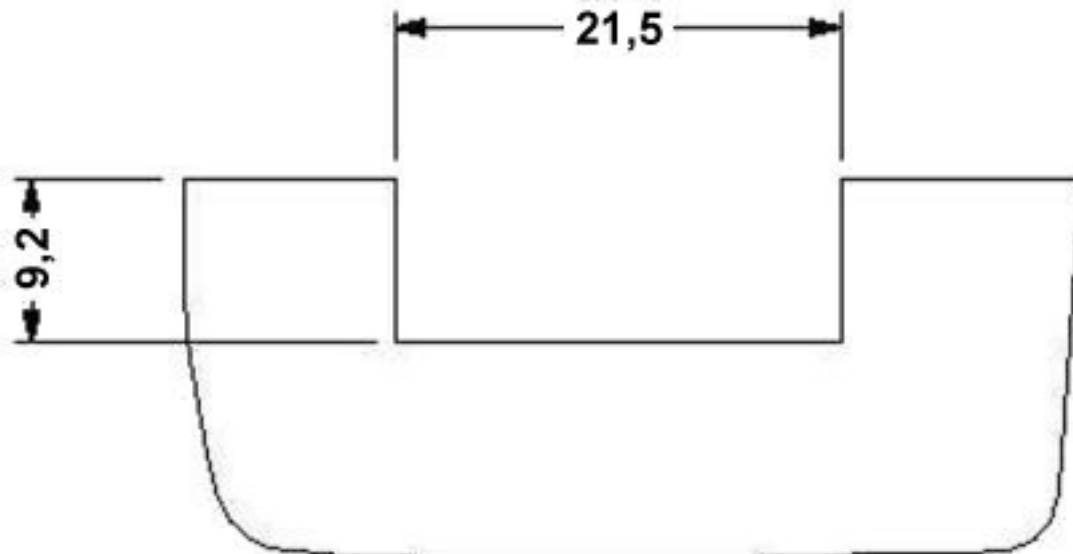

Housing cutout (panel thickness 1.6) for two transformer terminal blocks

## Molded transformer terminal block - VTRK 4 OG - 3004595

Dimensioned drawing

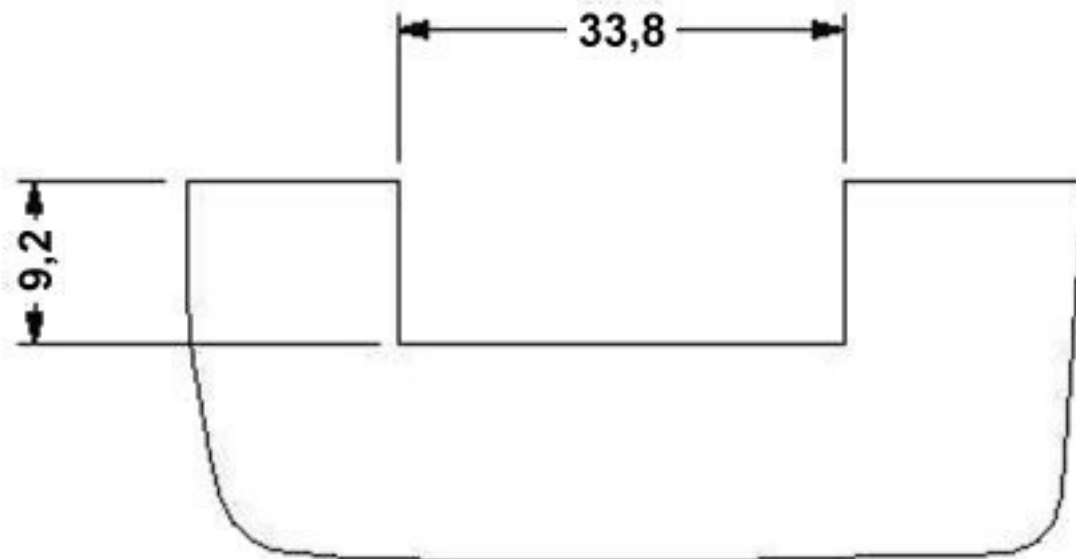

Housing cutout (panel thickness 1.6) for three transformer terminal blocks

Dimensioned drawing

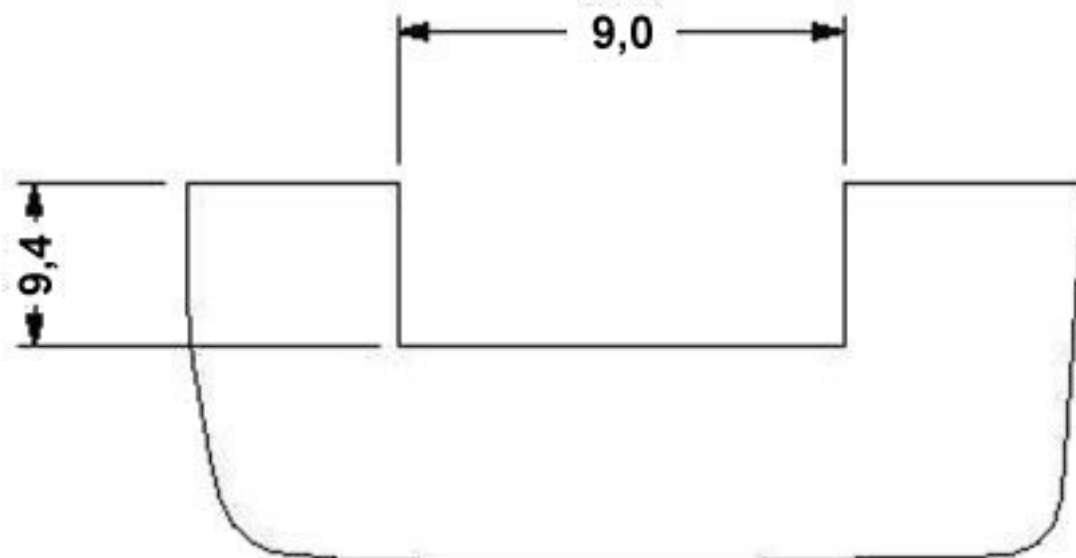

Housing cutout (panel thickness 1.7) for one transformer terminal block

## Molded transformer terminal block - VTRK 4 OG - 3004595

Dimensioned drawing

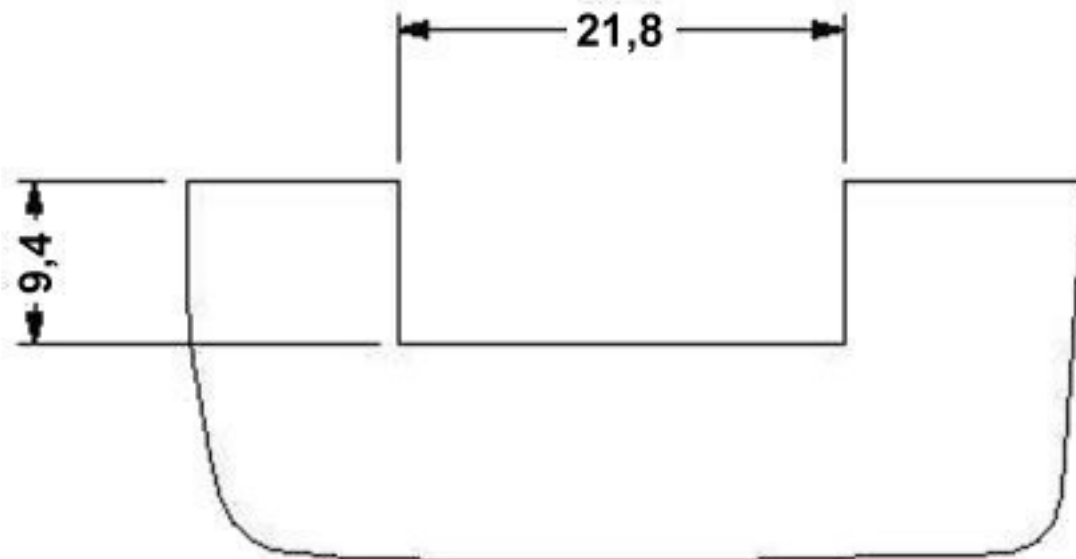

Housing cutout (panel thickness 1.7) for two transformer terminal blocks

Dimensioned drawing

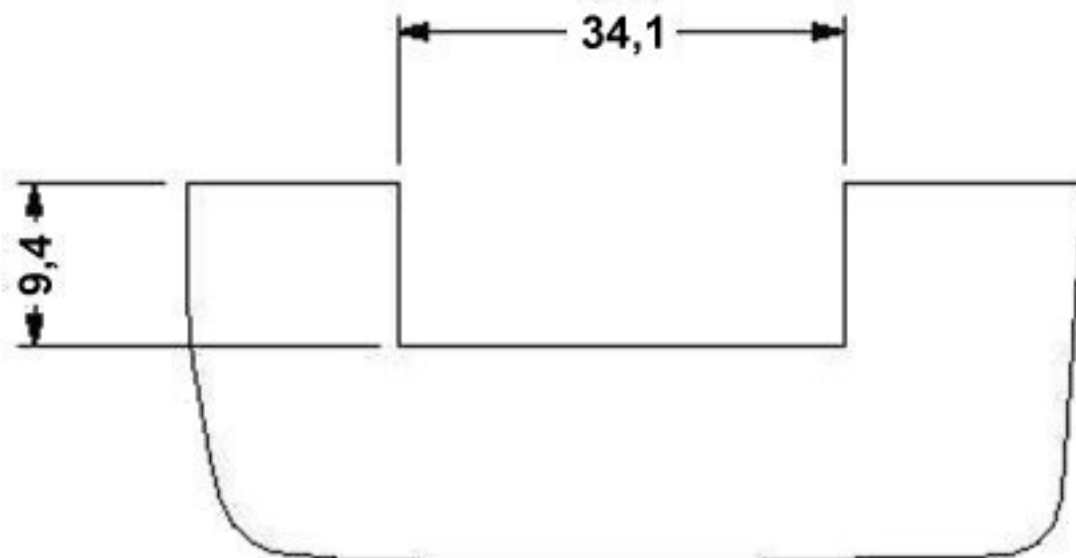

Housing cutout (panel thickness 1.7) for three transformer terminal blocks



## Molded transformer terminal block - VTRK 4 OG - 3004595

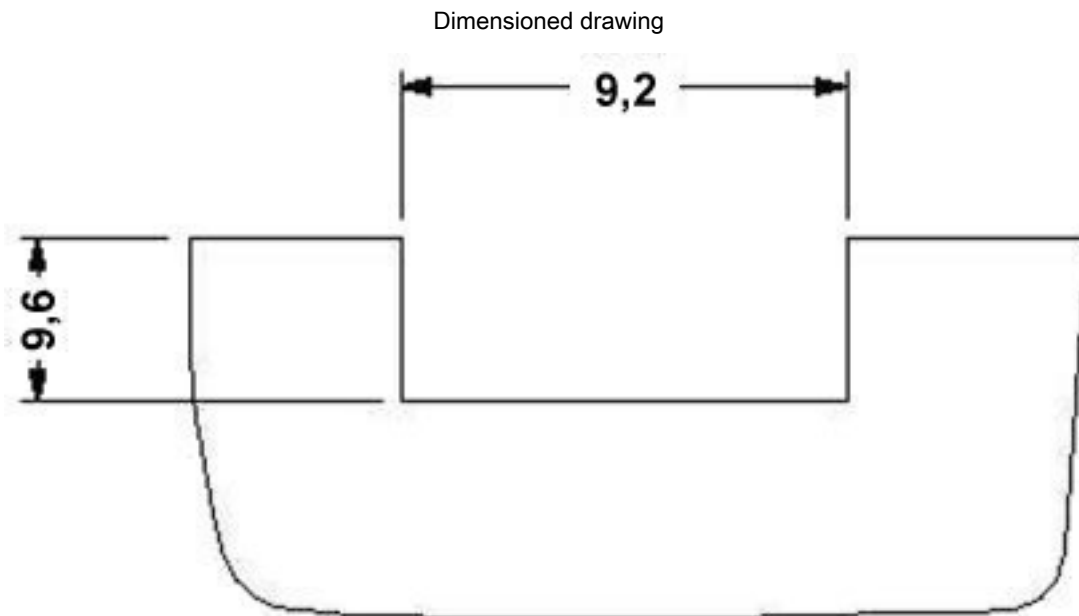

Housing cutout (panel thickness 1.8) for one transformer terminal block