



## Quad N-Channel 30-V (D-S) MOSFETs

PRODUCT SUMMARY				
Part Number	$V_{(BR)DSS}$ Min (V)	$r_{DS(on)}$ Max ( $\Omega$ )	$V_{GS(th)}$ (V)	$I_D$ (A)
VQ1001J	30	1 @ $V_{GS} = 12$ V	0.8 to 2.5	0.83
VQ1001P		1 @ $V_{GS} = 12$ V	0.8 to 2.5	0.53

### FEATURES

- Low On-Resistance: 0.85  $\Omega$
- Low Threshold: 1.4 V
- Low Input Capacitance: 38 pF
- Fast Switching Speed: 9 ns
- Low Input and Output Leakage

### BENEFITS

- Low Offset Voltage
- Low-Voltage Operation
- Easily Driven Without Buffer
- High-Speed Circuits
- Low Error Voltage

### APPLICATIONS

- Direct Logic-Level Interface: TTL/CMOS
- Drivers: Relays, Solenoids, Lamps, Hammers, Displays, Memories, Transistors, etc.
- Battery Operated Systems
- Solid-State Relays

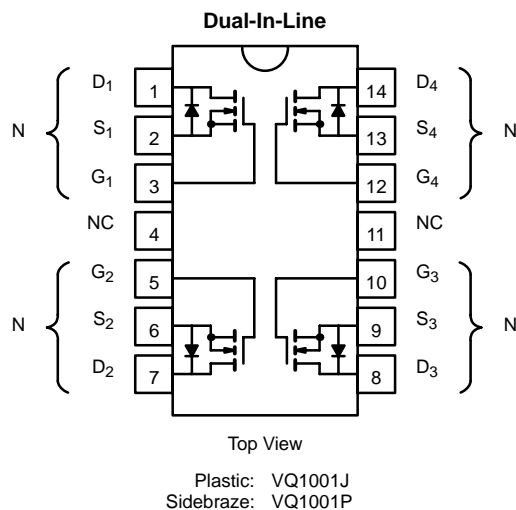

Device Marking  
Top View

VQ1001J  
"S" flfxyy

VQ1001P  
"S" flfxyy

"S" = Siliconix Logo  
f = Factory Code  
// = Lot Traceability  
xyy = Date Code

ABSOLUTE MAXIMUM RATINGS ( $T_A = 25^\circ\text{C}$ UNLESS OTHERWISE NOTED)					
Parameter	Symbol	Single	Total Quad	Unit	
Drain-Source Voltage	$V_{DS}$	30		V	
Gate-Source Voltage	$V_{GS}$	VQ1001J	$\pm 30$		
		VQ1001P	$\pm 20$		
Continuous Drain Current ( $T_J = 150^\circ\text{C}$ )	$I_D$	$T_A = 25^\circ\text{C}$	0.83	A	
		$T_A = 100^\circ\text{C}$	0.53		
Pulsed Drain Current <sup>a</sup>	$I_{DM}$	3			
Power Dissipation (Single)	$P_D$	$T_A = 25^\circ\text{C}$	1.3	2	W
		$T_A = 100^\circ\text{C}$	0.52	0.8	
Thermal Resistance, Junction-to-Ambient (Single)	$R_{thJA}$	96	62.5	$^\circ\text{C/W}$	
Operating Junction and Storage Temperature Range	$T_J, T_{stg}$	-55 to 150		$^\circ\text{C}$	

Notes

a. Pulse width limited by maximum junction temperature.

SPECIFICATIONS ( $T_A = 25^\circ\text{C}$ UNLESS OTHERWISE NOTED)						
Parameter	Symbol	Test Conditions	Limits			Unit
			Min	Typ <sup>a</sup>	Max	
<b>Static</b>						
Drain-Source Breakdown Voltage	$V_{(BR)DSS}$	$V_{GS} = 0\text{ V}, I_D = 10\ \mu\text{A}$	30	45		V
Gate-Threshold Voltage	$V_{GS(th)}$	$V_{DS} = V_{GS}, I_D = 1\ \text{mA}$	0.8	1.5	2.5	
Gate-Body Leakage	$I_{GSS}$	$V_{DS} = 0\ \text{V}, V_{GS} = \pm 16\ \text{V}$ $T_J = 125^\circ\text{C}$			$\pm 100$	nA
					$\pm 500$	
Zero Gate Voltage Drain Current	$I_{DSS}$	$V_{DS} = 30\ \text{V}, V_{GS} = 0\ \text{V}$			10	$\mu\text{A}$
		$V_{DS} = 24\ \text{V}, V_{GS} = 0\ \text{V}, T_J = 125^\circ\text{C}$			500	
On-State Drain Current <sup>b</sup>	$I_{D(on)}$	$V_{DS} = 10\ \text{V}, V_{GS} = 12\ \text{V}$	2	3.5		A
Drain-Source On-Resistance <sup>b</sup>	$r_{DS(on)}$	$V_{GS} = 5\ \text{V}, I_D = 0.2\ \text{A}$		1.2	1.75	$\Omega$
		$V_{GS} = 12\ \text{V}, I_D = 1\ \text{A}$		0.8	1	
		$T_J = 125^\circ\text{C}$		1.5	2	
Forward Transconductance <sup>b</sup>	$g_{fs}$	$V_{DS} = 10\ \text{V}, I_D = 0.5\ \text{A}$	200	500		mS
<b>Dynamic</b>						
Input Capacitance	$C_{iss}$	$V_{DS} = 15\ \text{V}, V_{GS} = 0\ \text{V}, f = 1\ \text{MHz}$		38	110	pF
Output Capacitance	$C_{oss}$			33	110	
Reverse Transfer Capacitance	$C_{rss}$			8	35	
<b>Switching<sup>c</sup></b>						
Turn-On Time	$t_{ON}$	$V_{DD} = 15\ \text{V}, R_L = 23\ \Omega, I_D \cong 0.6\ \text{A}$ $V_{GEN} = 10\ \text{V}, R_G = 25\ \Omega$		9	30	ns
Turn-Off Time	$t_{OFF}$			14	30	

## Notes

- For DESIGN AID ONLY, not subject to production testing.
- Pulse test:  $PW \leq 300\ \mu\text{s}$  duty cycle  $\leq 2\%$ .
- Switching time is essentially independent of operating temperature.

VNDQ03



**TYPICAL CHARACTERISTICS ( $T_A = 25^\circ\text{C}$  UNLESS OTHERWISE NOTED)**

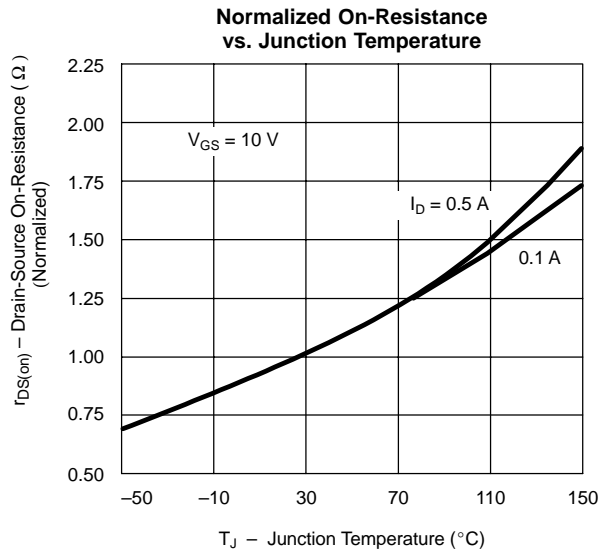
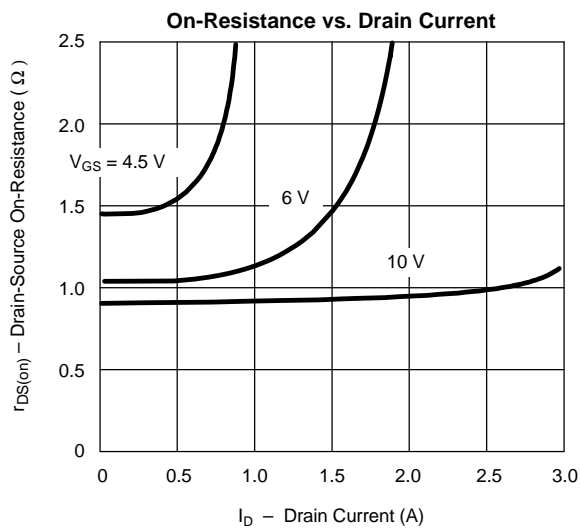
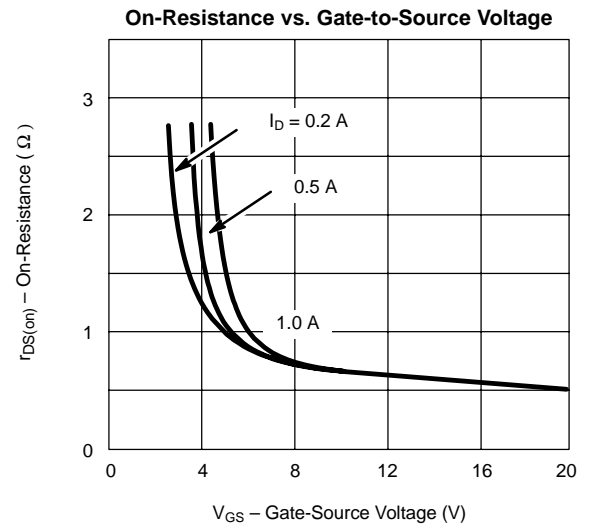
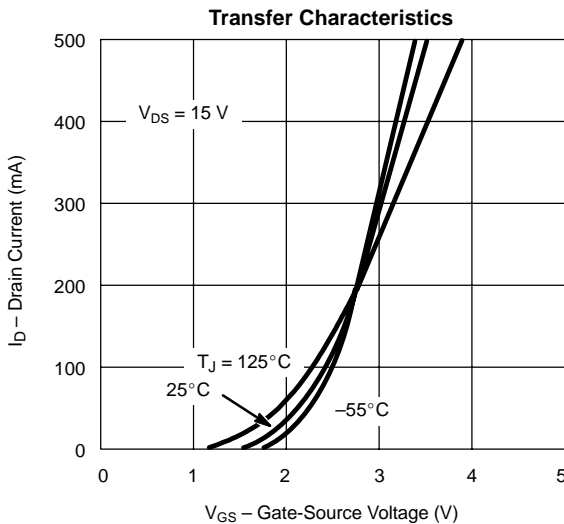
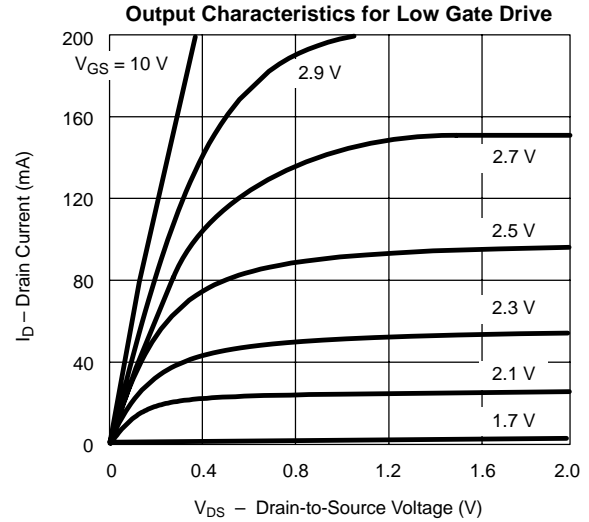
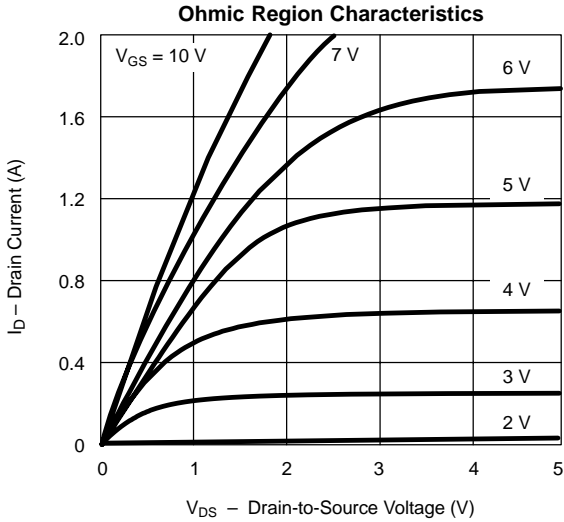

**TYPICAL CHARACTERISTICS ( $T_A = 25^\circ\text{C}$  UNLESS OTHERWISE NOTED)**

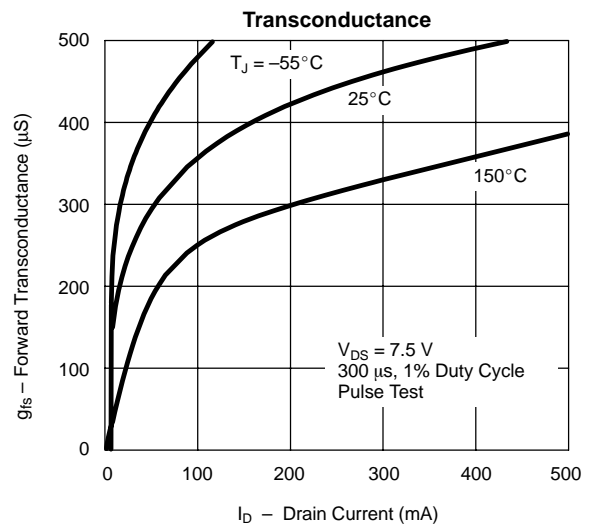
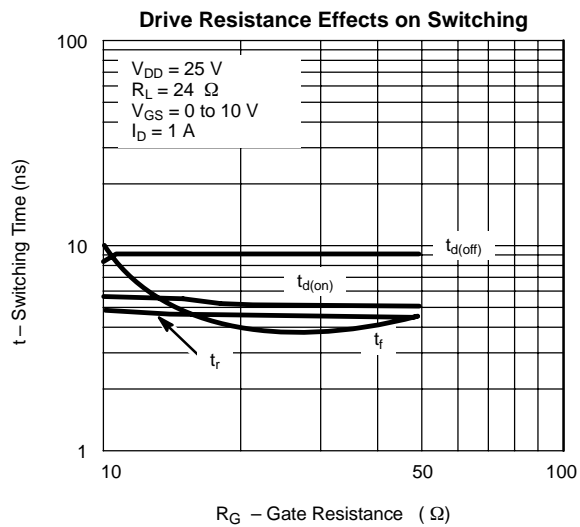
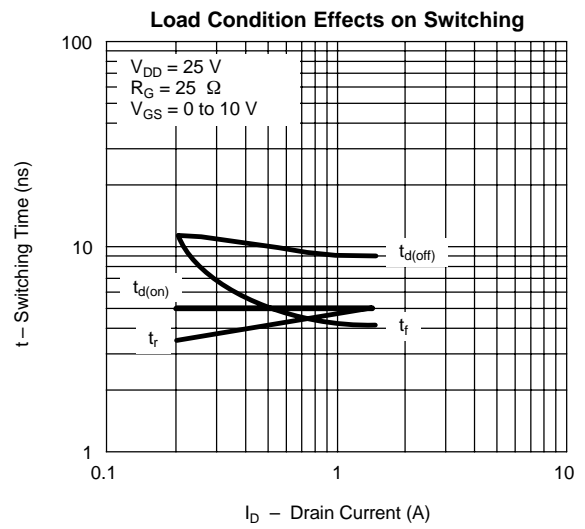
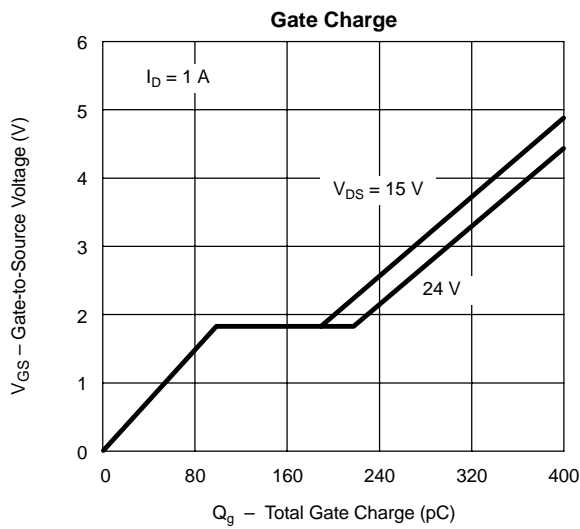
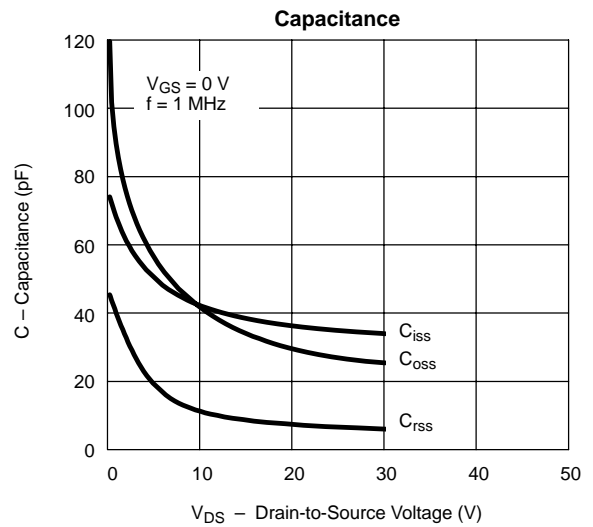
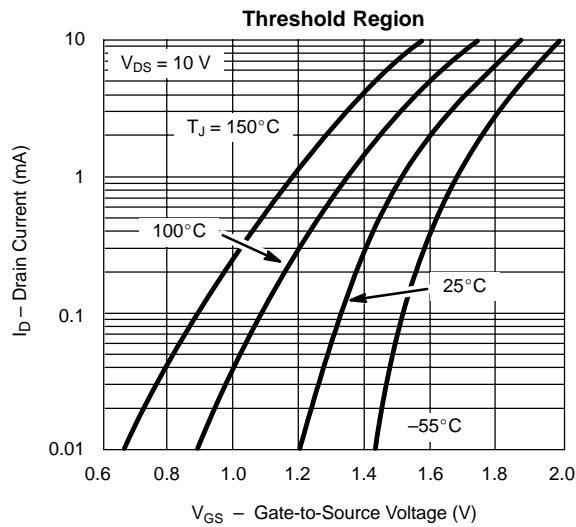



## Disclaimer

All product specifications and data are subject to change without notice.

Vishay Intertechnology, Inc., its affiliates, agents, and employees, and all persons acting on its or their behalf (collectively, "Vishay"), disclaim any and all liability for any errors, inaccuracies or incompleteness contained herein or in any other disclosure relating to any product.

Vishay disclaims any and all liability arising out of the use or application of any product described herein or of any information provided herein to the maximum extent permitted by law. The product specifications do not expand or otherwise modify Vishay's terms and conditions of purchase, including but not limited to the warranty expressed therein, which apply to these products.

No license, express or implied, by estoppel or otherwise, to any intellectual property rights is granted by this document or by any conduct of Vishay.

The products shown herein are not designed for use in medical, life-saving, or life-sustaining applications unless otherwise expressly indicated. Customers using or selling Vishay products not expressly indicated for use in such applications do so entirely at their own risk and agree to fully indemnify Vishay for any damages arising or resulting from such use or sale. Please contact authorized Vishay personnel to obtain written terms and conditions regarding products designed for such applications.

Product names and markings noted herein may be trademarks of their respective owners.