

LTC3882EUJ-1 High Efficiency Step-Down DC/DC Converter with Power System Management

DESCRIPTION

Demonstration circuit 2312A is a high current, high efficiency, dual phase synchronous buck converter featuring the [LTC3882EUJ-1](#), a dual output voltage mode controller with the additional features of differential V_{OUT} sense and dedicated PGOOD output on both channels, compared to LTC3882. The LTC3882-1 has the PMBus interface and power system management functions.

There are two versions of the boards available:

- **DC2312A-A:** Dual phase dual output configuration. Default output setting $V_{OUT0} = 1.5V/35A$, $V_{OUT1} = 1.0V/35A$.
- **DC2312A-B:** Dual phase single output configuration. Default output setting $V_{OUT0} = 1.0V/70A$.

The DC2312A powers up to default settings and produces power based on configuration resistors or with its nonvolatile memory without the need for any serial bus communication. This allows easy evaluation of the

DC/DC converter. To fully explore the extensive power system management features of the part, download the GUI software LTpowerPlay™ onto your PC and use LTC's I²C/SMBus/PMBus Dongle DC1613A to connect to the board. LTpowerPlay allows the user to reconfigure the part on-the-fly and store the configuration settings within its onboard EEPROM, along with viewing telemetry parameters that include voltage, current, temperature and fault status.

GUI Software LTpowerPlay Download

The software can be downloaded from:

<http://www.linear.com/LTpowerPlay>

Design files for this circuit board are available at

<http://www.linear.com/demo/DC2312A>

LT, LT, LTC, LTM, Linear Technology and the Linear logo are registered trademarks and LTpowerPlay is a trademark of Linear Technology Corporation. All other trademarks are the property of their respective owners.

PERFORMANCE SUMMARY Specifications are at $T_A = 25^\circ\text{C}$

SYMBOL	PARAMETER	CONDITIONS	MIN	TYP	MAX	UNITS
V_{IN}	Input Supply Range		7	12	14	V
V_{OUT0}	Output Voltage Range (-A Version)	$I_{OUT0} = 0A$ to 35A, $V_{IN} = 7V$ to 14V	0.5	1.5	2.0*	V
I_{OUT0}	Output Current Range (-A Version)		0		35**	A
V_{OUT1}	Output Voltage Range (-A Version)	$I_{OUT1} = 0A$ to 35A, $V_{IN} = 7V$ to 14V	0.5	1.0	2.0*	V
I_{OUT1}	Output Current Range (-A Version)		0		35**	A
V_{OUT0}	Output Voltage Range (-B Version)	$I_{OUT0} = 0A$ to 70A, $V_{IN} = 7V$ to 14V	0.5	1.0	2.0*	V
I_{OUT0}	Output Current Range (-B Version)		0		70**	A
F_{SW}	Factory Default Switching (-A Version)			500		kHz
F_{SW}	Factory Default Switching (-B Version)			450		kHz
EFFICIENCY	Full Load Efficiency (-A Version)	$V_{OUT0} = 1.5V$, $I_{OUT0} = 35A$, See Figure 5		90.6		%
		$V_{OUT1} = 1.0V$, $I_{OUT1} = 35A$, See Figure 5		88.0		%
	Full Load Efficiency (-B Version)	$V_{OUT0} = 1.0V$, $I_{OUT0} = 70A$, See Figure 6		87.8		%

*Note: The DC2312A uses 2.5V-rated low ESR PosCAP (Part No. 2R5TPE470M7) as output capacitors for optimized load transient performance. If $> 2.0V$ V_{OUT} is needed, 4V or 6.3V-rated output capacitors should be used.

**Note: When continuously running at full load, forced air flow is needed.

DEMO MANUAL

DC2312A-A/DC2312A-B

QUICK START PROCEDURE

Demonstration circuit 2312A makes it easy to set up to evaluate the performance of the LTC3882-1. Refer to Figures 2 and 3 for proper measurement equipment setup and follow the procedure below.

NOTE. When measuring the input or output voltage ripple, care must be taken to avoid a long ground lead on the oscilloscope probe. Measure the output voltage ripple by touching the probe tip directly across the C13 or C39. See Figure 4 for proper scope probe technique.

1. Make sure jumpers are in the following positions:

DC2312A-A Version

JUMPER	POSITION	FUNCTION
JP1	NC	Untie GPIO0B to GPIO1B
JP2	NC	Untie RUN0 to RUN1
JP4	ON	External 5V VDR for DrMOS
JP6	ON	External 5V V_{CC} for LTC3882-1

DC2312A-B Version

JUMPER	POSITION	FUNCTION
JP1	C	Tie GPIO0B to GPIO1B
JP2	C	Tie RUN0 to RUN1
JP4	ON	External 5V VDR for DrMOS
JP6	ON	External 5V V_{CC} for LTC3882-1

2. With power off, connect the input power supply to V_{IN} and GND. Connect active load to the output.
3. Make sure both RUN switches are OFF.
4. Turn on the power at the input.

Note. Make sure that the input voltage does not exceed 15V.

5. Turn on RUN switches as desired.
6. Check for the correct output voltage from V_{OUT0}^+ to V_{OUT0}^- and from V_{OUT1}^+ to V_{OUT1}^- .

Note. If there is no output, temporarily disconnect the load to make sure that the load is not set too high.

7. Once the proper output voltage is established, adjust the loads within the operating range and observe the output voltage regulation, ripple voltage, efficiency and other parameters.
8. Connect the dongle and control the output voltages from the GUI. See LTpowerPlay Quick Start Procedure session for details.

CONNECTING A PC TO DC2312A

You can use a PC to reconfigure the power management features of the LTC3882-1 such as: nominal V_{OUT} , margin set points, OV/UV limits, temperature fault limits, sequencing parameters, the fault log, fault responses, GPIO and

other functionality. The DC1613A dongle may be plugged in regardless of whether or not V_{IN} is present. Dongle can be hot plugged.

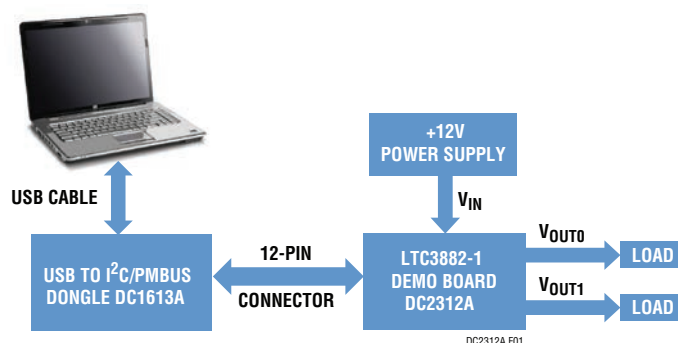

Figure 1. Demo Setup with PC

dc2312afb

QUICK START PROCEDURE

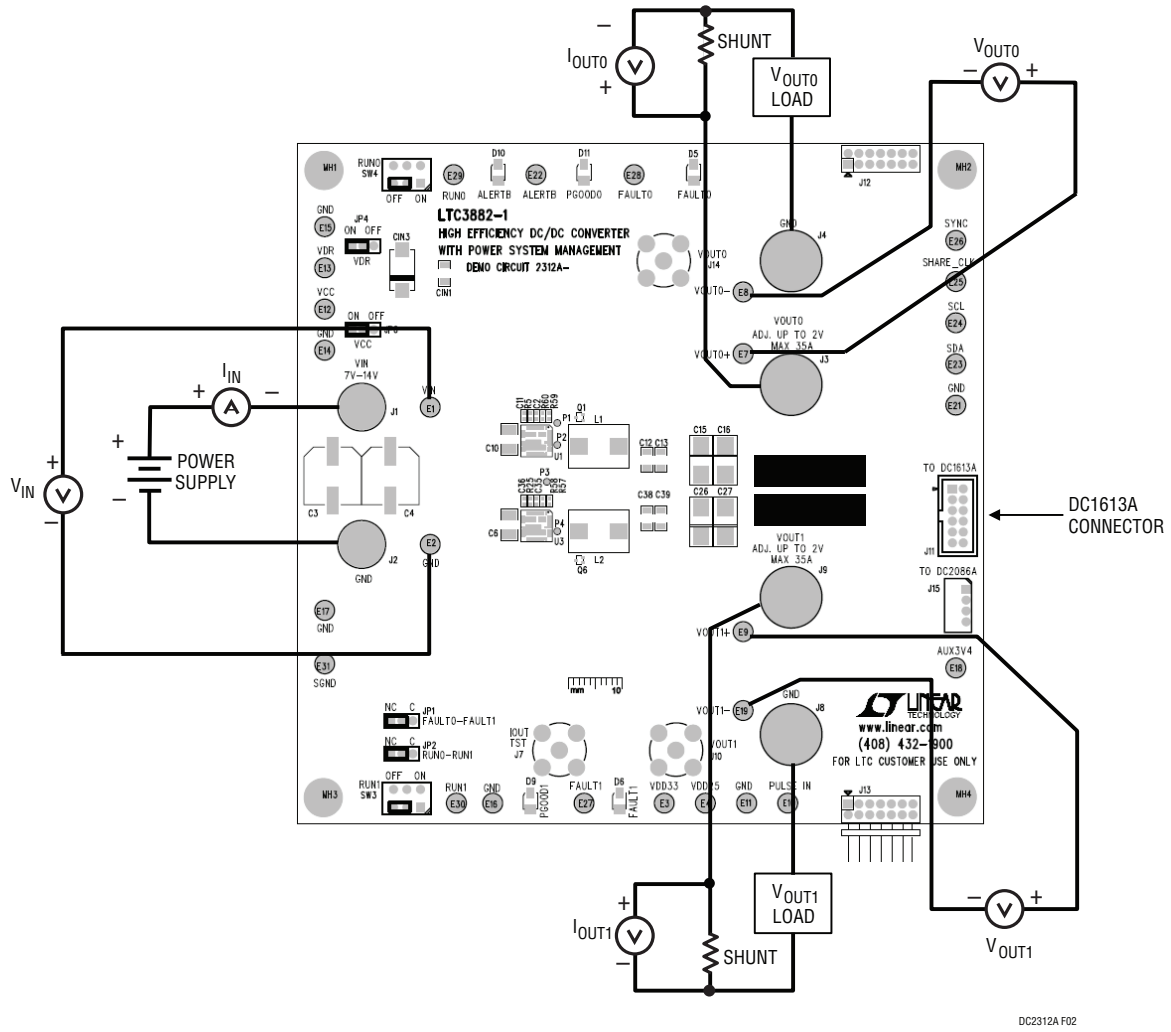

Figure 2. Power Test Setup for DC2312A-A

DEMO MANUAL

DC2312A-A/DC2312A-B

QUICK START PROCEDURE

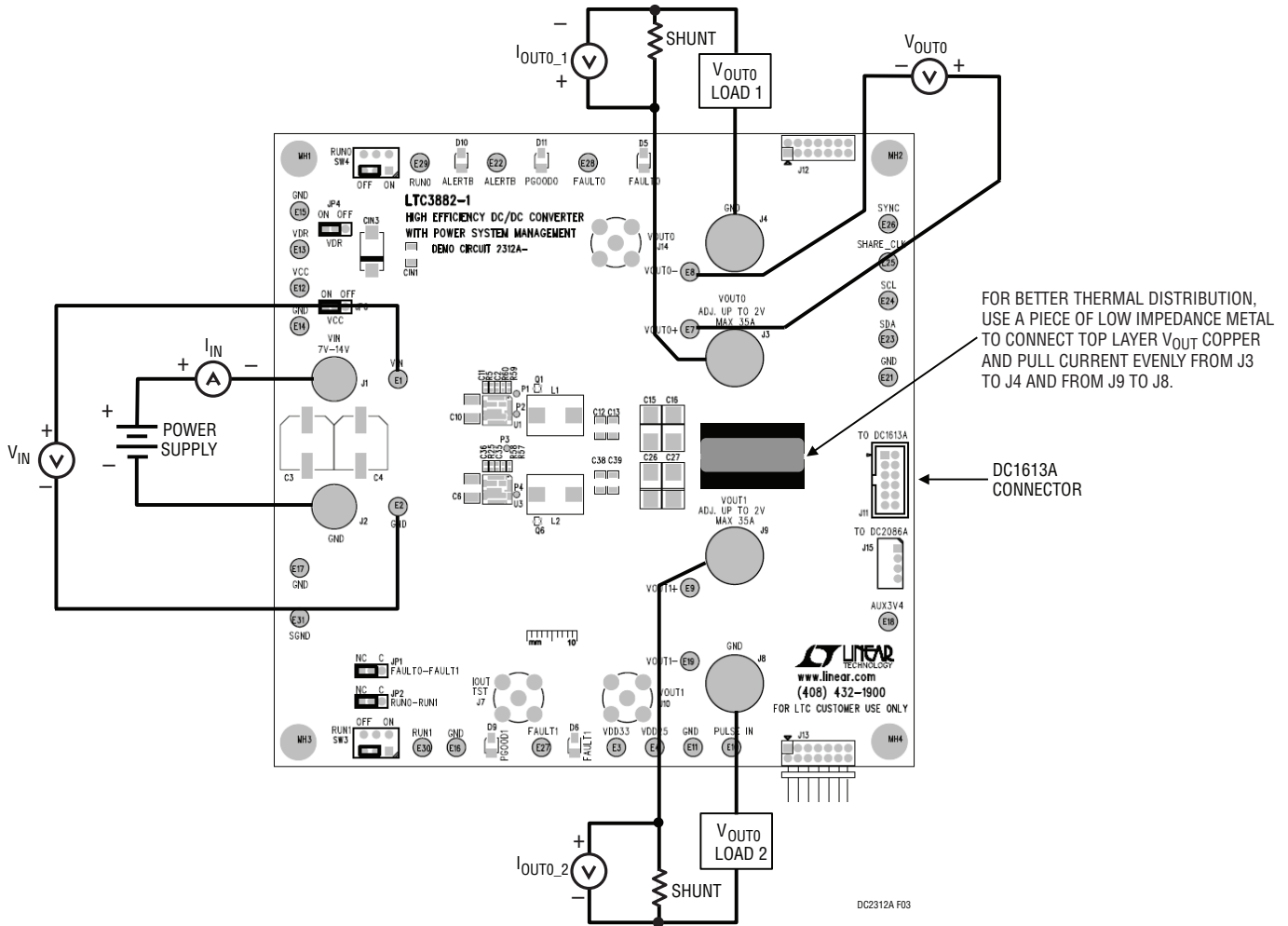

Figure 3. Power Test Setup for DC2312A-B

QUICK START PROCEDURE

COMBINING DC2312A WITH OTHER DIGITAL POWER DEMO BOARDS

The DC2312A may be plugged together in a multi-board array with other LTC power system management boards using J12 and J13.

MEASURING OUTPUT RIPPLE VOLTAGE

An accurate ripple measurement may be performed by using the configuration in Figure 4 across C13 or C39.

MEASURING EFFICIENCY (SEE FIGURES 5 AND 6)

To accurately measure efficiency of any configuration, do the following:

- Set JP4 and JP6 on the “OFF” position.
- Connect external 5V supply to VDR and V_{CC} turrets and measure its input current.
- Measure V_{IN} across the input ceramic capacitor (C10, C6). Measure V_{OUT} across the output ceramic capacitor (C13, C39).
- Add the loss from external 5V supply into the efficiency calculation.

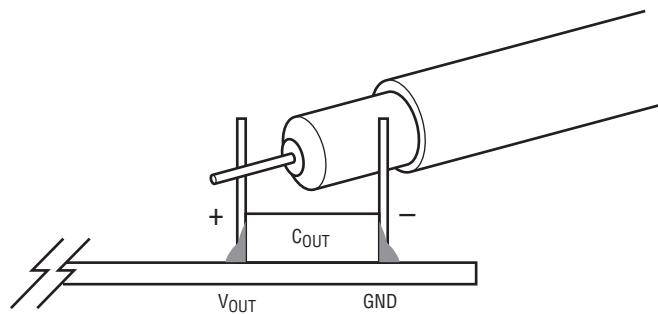

Figure 4. Measuring Output Voltage Ripple

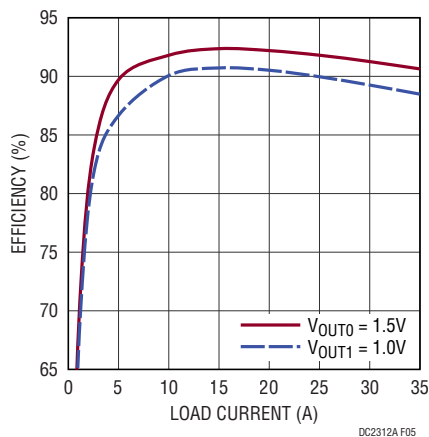

Figure 5. DC2312A-A, Typical Efficiency Curves, V_{IN} = 12V, F_{SW} = 500kHz, CCM

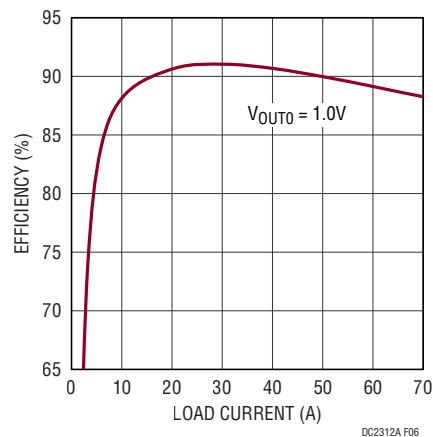

Figure 6. DC2312A-B, Typical Efficiency Curves, V_{IN} = 12V, F_{SW} = 450kHz, CCM

QUICK START PROCEDURE

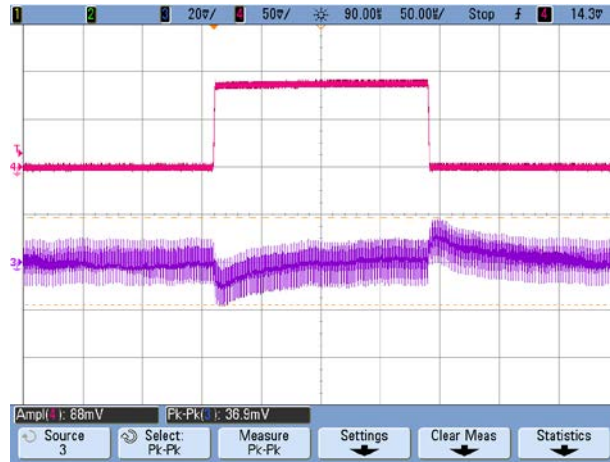

Figure 7. Load Transient Waveform DC2312A-A, $V_{IN} = 12V$, $V_{OUT0} = 1.5V$, $F_{SW} = 500kHz$, 0% to 25% (8.75A) Load Step

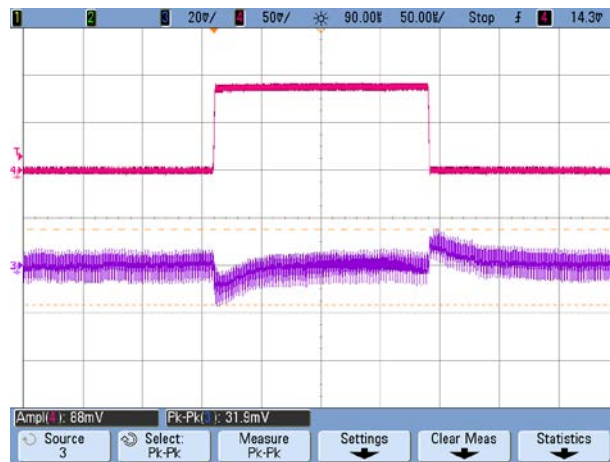

Figure 8. Load Transient Waveform DC2312A-A, $V_{IN} = 12V$, $V_{OUT1} = 1.0V$, $F_{SW} = 500kHz$, 0% to 25% (8.75A) Load Step

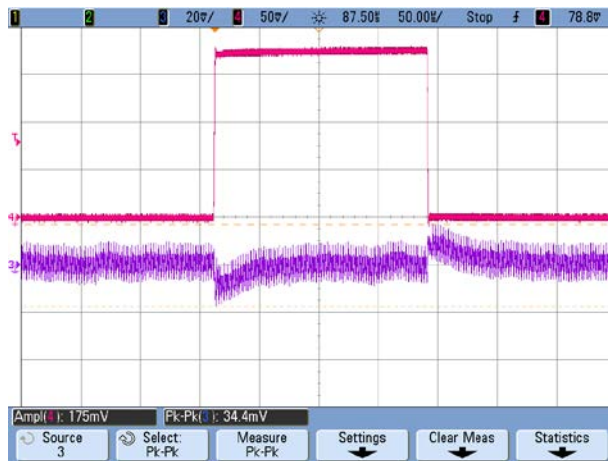

Figure 9. Load Transient Waveform DC2312A-B, $V_{IN} = 12V$, $V_{OUT0} = 1.0V$, $F_{SW} = 450kHz$, 0% to 25% (17.5A) Load Step

QUICK START PROCEDURE

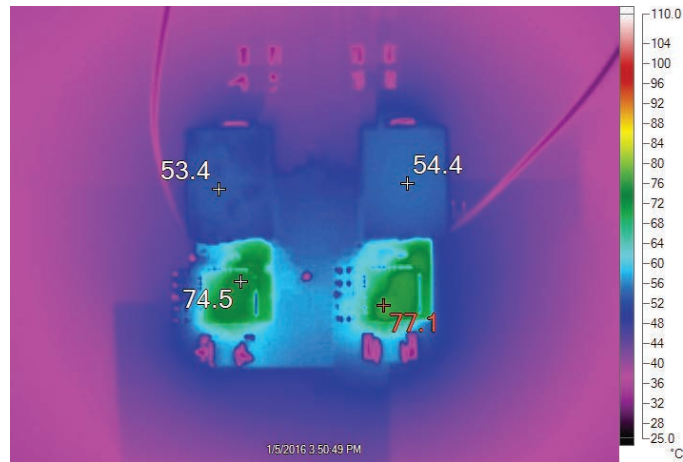

Figure 10. Thermal Picture of DC2312A-A, $V_{IN} = 12V$, $V_{OUT0} = 1.5V/35A$, $V_{OUT1} = 1.0V/35A$, $f_{SW} = 500kHz$, 400LFM Air Flow

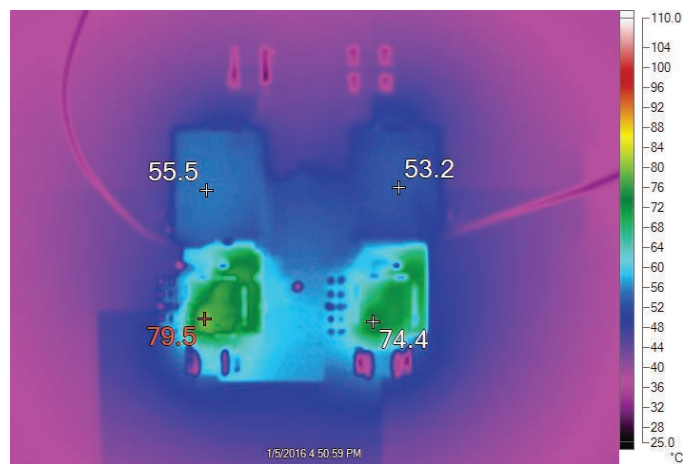

Figure 11. Thermal Picture of DC2312A-B, $V_{IN} = 12V$, $V_{OUT0} = 1.0V/70A$, $f_{SW} = 450kHz$, 400LFM Air Flow

DEMO MANUAL

DC2312A-A/DC2312A-B

LTpowerPlay SOFTWARE GUI

LTpowerPlay is a powerful Windows-based development environment that supports Linear Technology power system management ICs, including the LTC3880, LTC3882/LTC3882-1, LTC3883, LTM4676A, LTC2974 and the LTC2978. The software supports a variety of different tasks. You can use LTpowerPlay to evaluate Linear Technology ICs by connecting to a demo board system. LTpowerPlay can also be used in an offline mode (with no hardware present) in order to build a multi-chip configuration file that can be saved and reloaded at a later time. LTpowerPlay provides unprecedented diagnostic and debug features. It becomes a valuable diagnostic tool during board bring-up to program or tweak the power management scheme in a system, or to diagnose power

issues when bringing up rails. LTpowerPlay utilizes the DC1613A USB-to-SMBus controller to communicate with one of many potential targets, including the LTC3882-1's DC2312A demo system, or a customer board. The software also provides an automatic update feature to keep the software current with the latest set of device drivers and documentation. The LTpowerPlay software can be downloaded from:

<http://www.linear.com/LTpowerPlay>

To access technical support documents for LTC Digital Power Products visit Help. View online help on the LTpowerPlay menu.

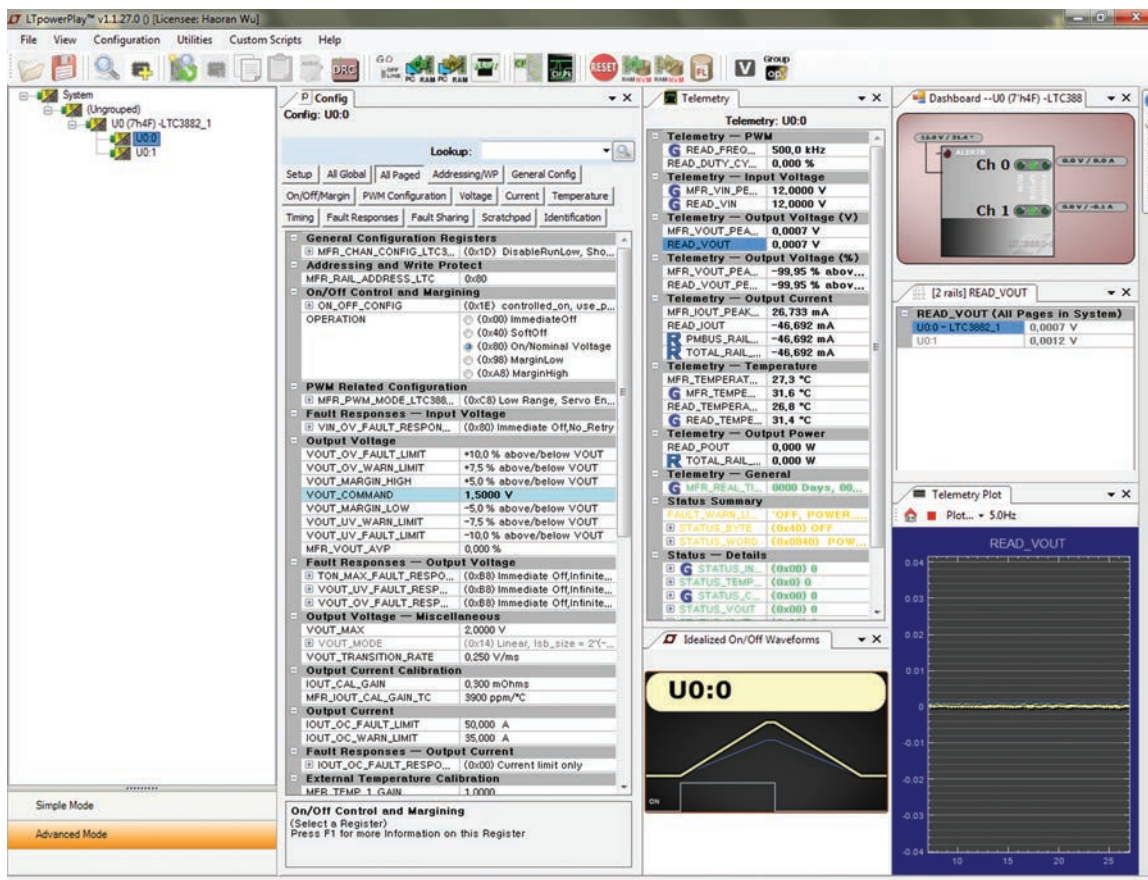

Figure 12. LTpowerPlay Main Interface

LTpowerPlay QUICK START PROCEDURE

The following procedure describes how to use LTpowerPlay to monitor and change the settings of LTC3882-1 (taking DC2312A-A as an example).

1. Download and install the LTpowerPlay GUI:

<http://www.linear.com/LTpowerPlay>

2. Launch the LTpowerPlay GUI.

- a. The GUI should automatically identify the DC2312A-A. The system tree on the left hand side should look like this:

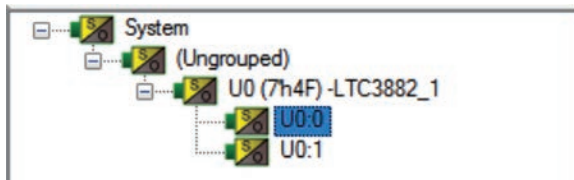

- b. A blue message box shows for a few seconds in the lower left hand corner, confirming that the LTC3882-1 is communicating:

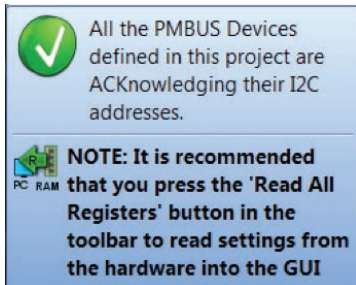

- c. In the Toolbar, click the “R” (RAM to PC) icon to read the RAM from the LTC3882-1. This reads the configuration from the RAM of LTC3882-1 and loads it into the GUI:



- d. If you want to change the output voltage to a different value, like 1.2V. In the Config tab, type in 1.2 in the VOUT_COMMAND box, like this:

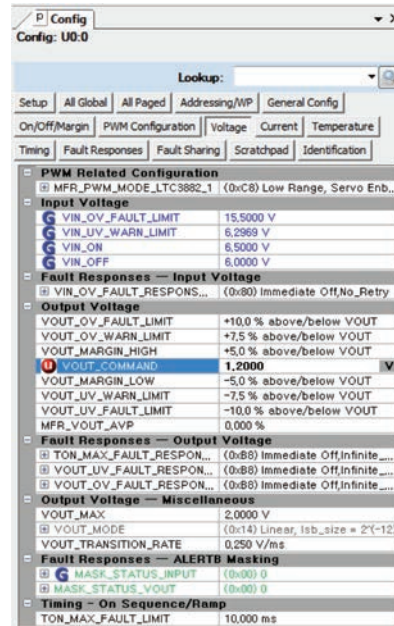

Then, click the “W” (PC to RAM) icon to write these register values to the LTC3882-1. After finishing this step, you will see the output voltage will change to 1.2V.



If the write is successful, you will see the following message:

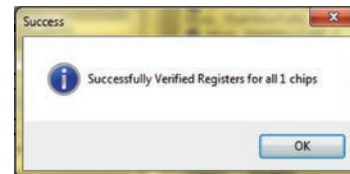

- e. You can save the changes into the NVM. In the toolbar, click “RAM to NVM” button, as following:



- f. Save the demo board configuration to a (*.proj) file. Click the Save icon and save the file with a new name.

DEMO MANUAL

DC2312A-A/DC2312A-B

PARTS LIST DC2312A-A

ITEM	QTY	REFERENCE	PART DESCRIPTION	MANUFACTURER/PART NUMBER
Required Circuit Components				
1	3	C5, C52, C53	CAP., X7R, 0.1µF, 16V, 10%, 0402	AVX, 0402YC104KAT2A
2	3	CF, COUT4, COUT5	CAP., X7R, 0.1µF, 16V, 10%, 0603	AVX, 0603YC104KAT2A
3	2	CFFW1, CFFW2	CAP., NP0, 22pF, 25V, 10%, 0402	AVX, 04023A220KAT2A
4	1	CIN1	CAP., X5R, 10µF, 25V, 20%, 1206	AVX, 12063D106MAT2A
5	2	COUT3, COUT7	CAP., X5R, 10µF, 16V, 10%, 0805	AVX, 0805YD106KAT2A
6	1	CIN3	CAP., TANT, 22µF, 35V, 20%, 7343	AVX, TCME226M035R0025
7	4	C6, C10, C33, C34	CAP., X5R, 22µF, 25V, 10%, 1210	MURATA, GRM32ER61E226KE15L
8	6	C1, C2, C8, C31, C35, C9	CAP., X5R, 1µF, 10V, 20%, 0402	MURATA, GRM155R61A105ME15D
9	1	C7	CAP., X5R, 2.2µF, 10V, 20%, 0402	Taiyo Yuden, LMK105BJ225MV-F
10	3	C47, C57, C58	CAP., X5R, 1µF, 16V, 10%, 0805	AVX, 0805YD105KAT2A
11	2	C3, C4	CAP., OS-CON, 330µF, 16V, 20%, F12	PANASONIC, 16SVP330M
12	2	C11, C36,	CAP., X7R, 100nF, 16V, 10%, 0402	MURATA, GRM155R71C104KA88D
13	1	C45	CAP., X7R, 100nF, 16V, 10%, 0603	TDK, C1608X7R1C404KT000N
14	8	C12, C13, C14, C23, C38, C39, C40, C43	CAP., X5R, 100µF, 6.3V, 20%, 1206	MURATA, GRM31CR60J107ME39L
15	8	C15, C16, C26, C27, C17, C18, C19, C28	CAP., POSCAP, 470µF, 2.5V, D2E SIZE	PANASONIC, EEFGX0E471R
16	2	L1, L2	IND., 0.17µH	COOPER., FP1007R3-R17-R
17	1	R1	RES., CHIP, 1, 1%, 0402	VISHAY, CRCW04021R00FKED
18	2	R2, R15	RES., CHIP, 24.9k, 1%, 0402	VISHAY, CRCW040224K9FKED
19	2	R93, R94	RES., CHIP, 200, 1%, 0603	VISHAY, CRCW0603200RFKED
20	3	R80, R81, R84	RES., CHIP, 127, 1%, 0603	VISHAY, CRCW0603127RFKEA
21	1	R87	RES., CHIP, 15.8k, 1%, 0603	VISHAY, CRCW060315K8FKEA
22	2	U1, U3	IC, HIGH FREQUENCY DrMOS MOUDLE	FAIRCHILD, FDMF5820DC
23	1	U2	IC, LTC3882EUJ-1, QFN 6mm × 6mm	LINEAR TECH., LTC3882EUJ-1#0134-1PBF
24	1	U5	IC EEPROM 2KBIT 400kHz 8 TSSOP	MICROCHIP, 24LC025-I/ST
25	1	U6	IC., LTC3607EMSE, 16 Pin QFM 3mm × 3mm	LINEAR TECH., LTC3607IMSE#PBF
26	1	R20	RES., CHIP, 53.6k, 1%, 0402	VISHAY, CRCW040253K6FKED
27	1	C50	CAP., NP0, 10pF, 25V, 10%, 0402	AVX, 04023A100KAT2A
28	1	C54	CAP., X7R, 220pF, 50V, 10%, 0402	MURATA, GRM155R71H221KA01D
29	2	C21, C55	CAP., X7R, 680pF, 50V, 10%, 0402	MURATA, GRM155R71H681KA01D

PARTS LIST DC2312A-A

ITEM	QTY	REFERENCE	PART DESCRIPTION	MANUFACTURER/PART NUMBER
Additional Demo Board Circuit Components				
1	0	D4, D7 (OPT)	OPTIONAL	
2	2	C20, C42	CAP., X5R, 0.22 μ F, 16V, 10%, 0402	TDK, C1005X5R1C224K
3	1	C22	CAP., X7R, 220pF, 50V, 10%, 0402	MURATA, GRM155R71H221KA01D
4	2	C29, C44	CAP., X7R, 0.01 μ F, 16V, 10%, 0603	AVX, 0603YC103KAT2A
5	2	C32, C48	CAP., X7R, 0.01 μ F, 16V, 10%, 0402	AVX, 0402YC103KAT2A
6	1	C30	CAP., NPO, 10pF, 25V, 10%, 0402	AVX, 04023A100KAT2A
7	2	D9, D11	LED, GREEN RECT CLEAR 0603	LITE ON, LTST-C193KGKT-5A
8	3	D5, D6, D10	LED, RED RECT CLEAR 0603	LITE ON, LTST-C193KRKT-5A
9	1	D8	DIODE, ULTRA LOW SCHOTTKY RECTIEIER	NXP SEMI. PMEG2005AEL,315
10	2	L3, L4	IND., 4.7 μ H	VISHAY, IHLP1616BZER4R7M11
11	2	Q1, Q6	TRANS, PNP GP 40V 200MA SC75-3	ON SEMI, MMBT3906TT1G
12	1	Q3	MOSFET, SPEED SRS 30V 30A LPAK	RENESAS, RJK0305DPB-00#J0
13	4	Q19, Q20, Q21, Q22	MOSFET, P-CH 20V 5.9A SOT-23	VISHAY, Si2365EDS-T1-GE3
14	2	Q23, Q24	MOSFET, N-CH 60V 115MA SOT23	DIODES INC., 2N7002-7-F
15	1	RF	RES., CHIP, 100, 1%, 0402	VISHAY, CRCW0402100RFKED
16	2	RPG1, RPG2	RES., CHIP, 100k, 1%, 0402	VISHAY, CRCW0402100KFKED
17	2	RSD1, RSD2	RES., CHIP, 5.1M, 5%, 0402	VISHAY, CRCW04025M10JNED
18	2	R5, R25	RES., CHIP, 0, 0402	VISHAY, CRCW04020000Z0ED
19	5	R16, R24, R71, R73, R83	RES., CHIP, 0, 0603	VISHAY, CRCW06030000Z0EA
20	1	R45	SENSE RES., 0.010 Ω 1W 1% 2512	PANASONIC, ERJ-M1WSF10MU
21	1	R48	SENSE RES., 0.001 Ω 1W 1% 2512	PANASONIC, ERJ-M1WTF1M0U
22	0	R29, R30, R31, R32, R33, R34, R35, R36, R37, R38, R39, R40, R53, R68, R72, R74, R75, R78, R82, R90, R91, R92 (OPT)	OPTIONAL	
23	2	R7, R27	RES., CHIP, 2.67k, 1%, 0402	VISHAY, CRCW04022K67FKED
24	1	R9	RES., CHIP, 1.24k, 1%, 0402	VISHAY, CRCW04021K24FKED
25	13	R10, R11, R13, R14, R17, R19, R21, R28, R41, R42, R43, R44, R86	RES., CHIP, 10k, 1%, 0603	VISHAY, CRCW060310K0FKEA
22	1	R12	RES., CHIP, 53.6k, 1%, 0402	VISHAY, CRCW040253K6FKED
23	4	R57, R58, R59, R60	RES., CHIP, 1k, 1%, 0402	VISHAY, CRCW04021K00FKED
24	2	R63, R65	RES., CHIP, 121k, 1%, 0402	VISHAY, CRCW0402121KFKED
25	2	R64, R66	RES., CHIP, 887k, 1%, 0402	VISHAY, CRCW0402887KFKED
26	2	R69, R70	RES., CHIP, 10, 1%, 0603	VISHAY, CRCW060310R0FKEA
27	2	R76, R77	RES., CHIP, 4.99k, 1%, 0603	VISHAY, CRCW06034K99FKEA
28	0	R62, R67, R98, R99, R101	OPTIONAL	
29	0	R61, R100	OPTIONAL	
30	2	R22, R46	RES., CHIP, 0, 0603	VISHAY, CRCW06030000Z0EA
31	0	C37, C41	OPTIONAL	
32	1	R18	RES., CHIP, 1.24k, 1%, 0402	VISHAY, CRCW04021K24FKED
33	0	R49	OPTIONAL	

DEMO MANUAL

DC2312A-A/DC2312A-B

PARTS LIST DC2312A-A

ITEM	QTY	REFERENCE	PART DESCRIPTION	MANUFACTURER/PART NUMBER
Hardware – For Demo Board Only				
1	28	E1-E4, E7-E19, E21-E31	TESTPOINT, TURRET, .094"	MILL-MAX, 2501-2-00-80-00-00-07-0
2	2	J1, J2	BANANA SMALL	KEYSTONE, 575-4
3	4	J3, J4, J8, J9	STUD, TESTPIN	PEM, KFH-032-10
4	8	J3, J4, J8, J9 (X2)	NUT, BRASS 10-32	ANY #10-32M/S BR PL
5	4	J3, J4, J8, J9	RING, LUG #10	KEYSTONE, 8205
6	4	J3, J4, J8, J9	WASHER, TIN PLATED BRASS	ANY #10 EXT BZ TN
7	4	JP1, JP2, JP4, JP6	HEADER, 3 PIN 0.079 SINGLE ROW	WURTH, 620 003 111 21
8	4	JP1, JP2, JP4, JP6	SHUNT	SAMTEC, 2SN-BK-G
9	2	SW3, SW4	CONNECTOR, SUB MINIATURE SLIDE SWITCHES	C&K., JS202011CQN
10	3	J7, J10, J14	CONN., BNC PC MOUNT RECEPT. JACK, 50Ω, TF-4 POST	CONNEX, 112404
11	1	J11	HEADER 12POS 2MM STR DL PCB	FCI, 98414-G06-12ULF
12	1	J12	CONN., HEADER, 2X7, 2mm, R/A (F)	SULLINS, NPPN072FJFN-RC
13	1	J13	CONN., HEADER, 2X7, 2mm, R/A (M)	MOLEX, 87760-1416
14	1	J15	HEADER, 4 PINS, SHROUDED	HIROSE, DF3A-4P-2DSA

PARTS LIST DC2312A-B

ITEM	QTY	REFERENCE	PART DESCRIPTION	MANUFACTURER/PART NUMBER
Required Circuit Components				
1	3	C5, C52, C53	CAP., X7R, 0.1µF, 16V, 10%, 0402	AVX, 0402YC104KAT2A
2	3	CF, COUT4, COUT5	CAP., X7R, 0.1µF, 16V, 10%, 0603	AVX, 0603YC104KAT2A
3	2	CFFW1, CFFW2	CAP., NPO, 22pF, 25V, 10%, 0402	AVX, 04023A220KAT2A
4	1	CIN1	CAP., X5R, 10µF, 25V, 20%, 1206	AVX, 12063D106MAT2A
5	2	COUT3, COUT7	CAP., X5R, 10µF, 16V, 10%, 0805	AVX, 0805YD106KAT2A
6	1	CIN3	CAP., TANT, 22µF, 35V, 20%, 7343	AVX, TCME226M035R0025
7	4	C6, C10, C33, C34	CAP., X5R, 22µF, 25V, 10%, 1210	MURATA, GRM32ER61E226KE15L
8	6	C1, C2, C8, C31, C35, C9	CAP., X5R, 1µF, 10V, 20%, 0402	MURATA, GRM155R61A105ME15D
9	1	C7	CAP., X5R, 2.2µF, 10V, 20%, 0402	Taiyo Yuden, LMK105BJ225MV-F
10	3	C47, C57, C58	CAP., X5R, 1µF, 16V, 10%, 0805	AVX, 0805YD105KAT2A
11	2	C3, C4	CAP., OS-CON, 330µF, 16V, 20%, F12	PANASONIC, 16SVP330M
12	2	C11, C36	CAP., X7R, 100nF, 16V, 10%, 0402	MURATA, GRM155R71C104KA88D
13	1	C45	CAP., X7R, 100nF, 16V, 10%, 0603	TDK, C1608X7R1C404KT000N
14	8	C12, C13, C14, C23, C38, C39, C40, C43	CAP., X5R, 100µF, 6.3V, 20%, 1206	MURATA, GRM31CR60J107ME39L
15	8	C15, C16, C26, C27, C17, C18, C19, C28	CAP., POSCAP, 470µF, 2.5V, D2E SIZE	PANASONIC, EEFGX0E471R
16	2	L1, L2	IND., 0.17µH	COOPER., FP1007R3-R17-R
17	1	R1	RES., CHIP, 1, 1%, 0402	VISHAY, CRCW04021R00FKED
18	2	R2, R15	RES., CHIP, 24.9k, 1%, 0402	VISHAY, CRCW040224K9FKED
19	2	R93, R94	RES., CHIP, 200, 1%, 0603	VISHAY, CRCW0603200RFKED
20	3	R80, R81, R84	RES., CHIP, 127, 1%, 0603	VISHAY, CRCW0603127RFKEA
21	1	R87	RES., CHIP, 15.8k, 1%, 0603	VISHAY, CRCW060315K8FKEA
22	2	U1, U3	IC, HIGH FREQUENCY DrMOS MOUDLE	FAIRCHILD, FDMF5820DC
23	1	U2	IC, LTC3882EUJ-1, QFN 6mm × 6mm	LINEAR TECH., LTC3882EUJ-1#0315-1PBF
24	1	U5	IC EEPROM 2KBIT 400kHz 8TSSOP	MICROCHIP, 24LC025-I/ST
25	1	U6	IC., LTC3607EMSE, 16 Pin QFM 3 × 3mm	LINEAR TECH., LTC3607IMSE#PBF
26	2	C37, C41	CAP., NPO, 22pF, 25V, 10%, 0402	AVX, 04023A220KAT2A
27	1	R49	RES., CHIP, 0, 2512, 1W	VISHAY, CRCW25120000Z0EG
28	1	C21	CAP., X7R, 470pF, 50V, 10%, 0402	MURATA, GRM155R71H471KA01D

DEMO MANUAL

DC2312A-A/DC2312A-B

PARTS LIST DC2312A-B

ITEM	QTY	REFERENCE	PART DESCRIPTION	MANUFACTURER/PART NUMBER
Additional Demo Board Circuit Components				
1	0	D4, D7 (OPT)	OPTIONAL	
2	2	C20, C42	CAP., X5R, 0.22 μ F, 16V, 10%, 0402	TDK, C1005X5R1C224K
3	1	C22	CAP., X7R, 220pF, 50V, 10%, 0402	MURATA, GRM155R71H221KA01D
4	2	C29, C44	CAP., X7R, 0.01 μ F, 16V, 10%, 0603	AVX, 0603YC103KAT2A
5	2	C32, C48	CAP., X7R, 0.01 μ F, 16V, 10%, 0402	AVX, 0402YC103KAT2A
6	1	C30	CAP., NPO, 10pF, 25V, 10%, 0402	AVX, 04023A100KAT2A
7	2	D9, D11	LED, GREEN RECT CLEAR 0603	LITE ON, LTST-C193KGKT-5A
8	3	D5, D6, D10	LED, RED RECT CLEAR 0603	LITE ON, LTST-C193KRKT-5A
9	1	D8	DIODE, ULTRA LOW SCHOTTKY RECTIFIER	NXP SEMI. PMEG2005AEL,315
10	2	L3, L4	IND., 4.7 μ H	VISHAY, IHLP1616BZER4R7M11
11	2	Q1, Q6	TRANS, PNP GP 40V 200MA SC75-3	ON SEMI, MMBT3906TT1G
12	1	Q3	MOSFET, SPEED SRS 30V 30A LPAK	RENESAS, RJK0305DPB-00#J0
13	4	Q19, Q20, Q21, Q22	MOSFET, P-CH 20V 5.9A SOT-23	VISHAY, Si2365EDS-T1-GE3
14	2	Q23, Q24	MOSFET, N-CH 60V 115MA SOT23	DIODES INC., 2N7002-7-F
15	1	RF	RES., CHIP, 100, 1%, 0402	VISHAY, CRCW0402100RFKED
16	2	RPG1, RPG2	RES., CHIP, 100k, 1%, 0402	VISHAY, CRCW0402100KFED
17	2	RSD1, RSD2	RES., CHIP, 5.1M, 5%, 0402	VISHAY, CRCW04025M10JNED
18	2	R5, R25	RES., CHIP, 0, 0402	VISHAY, CRCW04020000Z0ED
19	5	R16, R24, R71, R73, R83	RES., CHIP, 0, 0603	VISHAY, CRCW06030000Z0EA
20	1	R45	SENSE RES., 0.010 Ω , 1W, 1%, 2512	PANASONIC, ERJ-M1WSF10MU
21	1	R48	SENSE RES., 0.001 Ω , 1W, 1%, 2512	PANASONIC, ERJ-M1WTF1M0U
22	0	R29, R30, R31, R32, R33, R34, R35, R36, R37, R38, R39, R40, R53, R68, R72, R74, R75, R78, R82, R90, R91, R92 (OPT)	OPTIONAL	
23	2	R7, R27	RES., CHIP, 2.67k, 1%, 0402	VISHAY, CRCW04022K67FKED
24	1	R9	RES., CHIP, 1.24k, 1%, 0402	VISHAY, CRCW04021K24FKED
25	13	R10, R11, R13, R14, R17, R19, R21, R28, R41, R42, R43, R44, R86	RES., CHIP, 10k, 1%, 0603	VISHAY, CRCW060310K0FKEA
22	1	R12	RES., CHIP, 64.9k, 1%, 0402	VISHAY, CRCW040264K9FKED
23	4	R57, R58, R59, R60	RES., CHIP, 1k, 1%, 0402	VISHAY, CRCW04021K00FKED
24	2	R63, R65	RES., CHIP, 121k, 1%, 0402	VISHAY, CRCW0402121KFKED
25	2	R64, R66	RES., CHIP, 887k, 1%, 0402	VISHAY, CRCW0402887KFKED
26	2	R69, R70	RES., CHIP, 10, 1%, 0603	VISHAY, CRCW060310R0FKEA
27	2	R76, R77	RES., CHIP, 4.99k, 1%, 0603	VISHAY, CRCW06034K99FKEA
28	5	R62, R67, R98, R99, R101	RES., CHIP, 0, 0402	VISHAY, CRCW04020000Z0ED
29	2	R61, R100	RES., CHIP, 0, 0603	VISHAY, CRCW06030000Z0EA
30	0	R22, R46	OPTIONAL	
31	0	R18	OPTIONAL	
32	0	R20	OPTIONAL	
33	0	C50	OPTIONAL	
34	0	C54	OPTIONAL	
35	0	C55	OPTIONAL	

dc2312afb

PARTS LIST DC2312A-B

ITEM	QTY	REFERENCE	PART DESCRIPTION	MANUFACTURER/PART NUMBER
Hardware – For Demo Board Only				
1	28	E1-E4, E7-E19, E21-E31	TESTPOINT, TURRET, .094"	MILL-MAX, 2501-2-00-80-00-00-07-0
2	2	J1, J2	BANANA SMALL	KEYSTONE, 575-4
3	4	J3, J4, J8, J9	STUD, TEST PIN	PEM, KFH-032-10
4	8	J3, J4, J8, J9 (X2)	NUT, BRASS 10-32	ANY #10-32M/S BR PL
5	4	J3, J4, J8, J9	RING, LUG #10	KEYSTONE, 8205
6	4	J3, J4, J8, J9	WASHER, TIN PLATED BRASS	ANY #10 EXT BZ TN
7	4	JP1, JP2, JP4, JP6	HEADER, 3 PIN 0.079 SINGLE ROW	WURTH, 620 003 111 21
8	4	JP1, JP2, JP4, JP6	SHUNT	SAMTEC, 2SN-BK-G
9	2	SW3, SW4	CONNECTOR, SUB MINIATURE SLIDE SWITCHES	C&K.,JS202011CQN
10	3	J7, J10, J14	CONN., BNC PC MOUNT RECEPT. JACK, 50Ω, TF-4 POST	CONNEX, 112404
11	1	J11	HEADER 12POS 2MM STR DL PCB	FCI, 98414-G06-12ULF
12	1	J12	CONN., HEADER, 2mm × 7mm, 2mm, R/A (F)	SULLINS, NPPN072FJFN-RC
13	1	J13	CONN., HEADER, 2mm × 7mm, 2mm, R/A (M)	MOLEX, 87760-1416
14	1	J15	HEADER, 4 PINS, SHROUDED	HIROSE, DF3A-4P-2DSA

DEMO MANUAL

DC2312A-A/DC2312A-B

SCHEMATIC DIAGRAM DC2312A-A

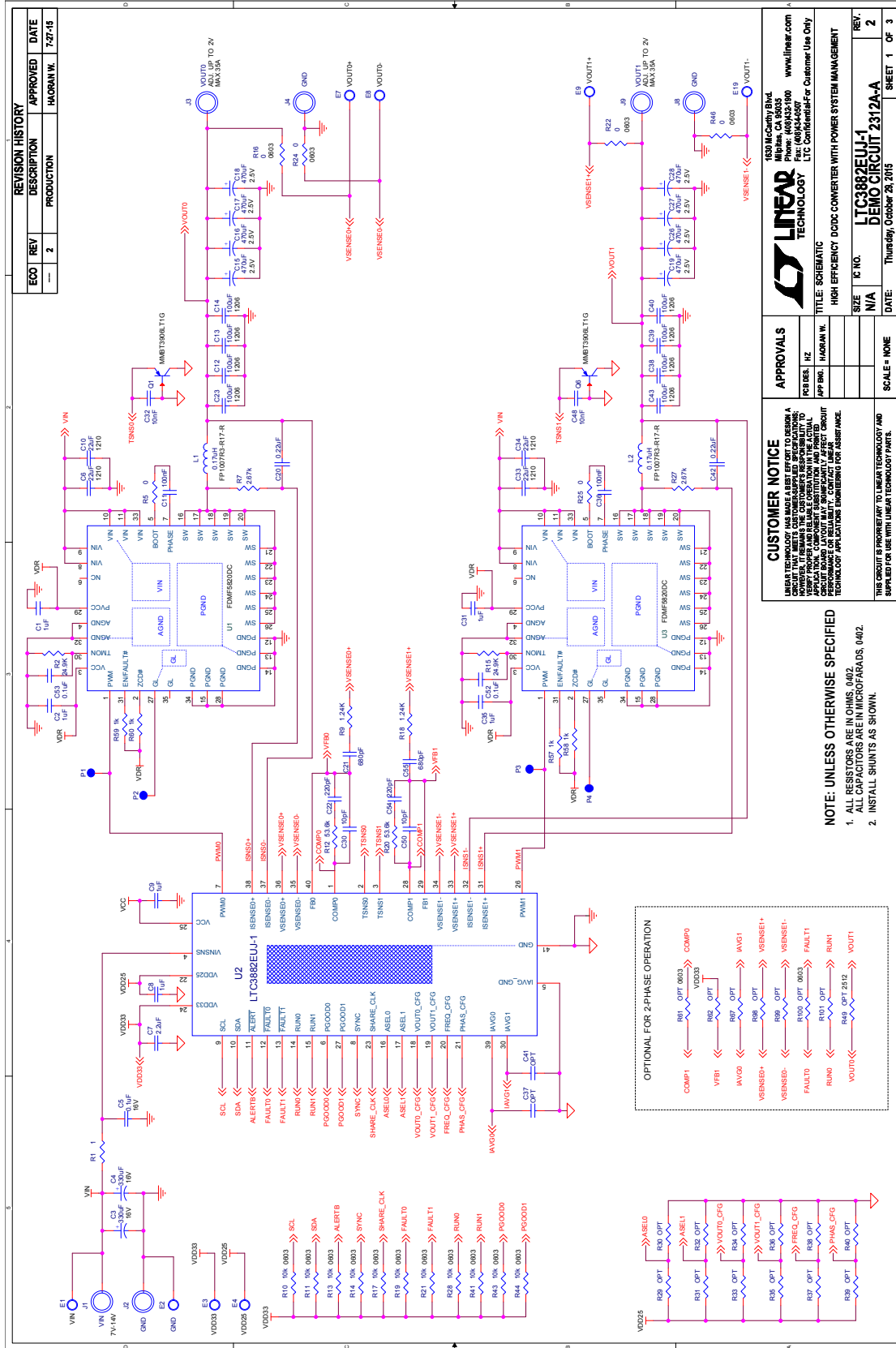

LINEAR TECHNOLOGY
 1630 Lincoln Drive
 Fremont, CA 94538
 Phone: (408)435-5000
 Fax: (408)435-5001
 www.linear.com
 LTC Confidential - For Customer Use Only

TITLE: SCHEMATIC
DESCRIPTION: HIGH EFFICIENCY DC/DC CONVERTER WITH POWER SYSTEM MANAGEMENT
REV: 2
DATE: Thursday, October 29, 2015

APPROVALS
 DESIGNER: HUORAN W.
 DATE:

SCALE: NONE
SHEET 1 OF 3

SCHEMATIC DIAGRAM DC2312A-A

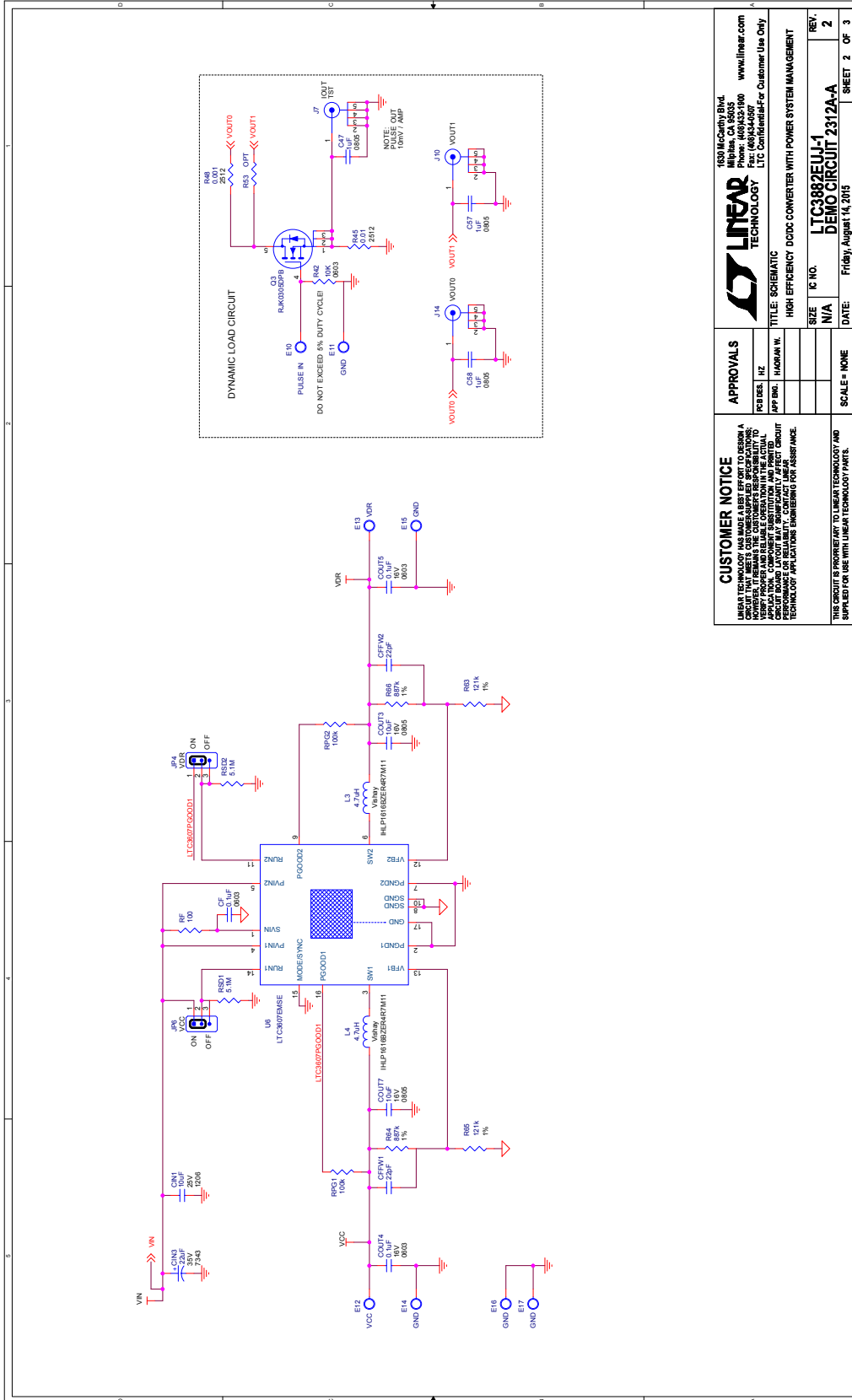

DEMO MANUAL DC2312A-A/DC2312A-B

SCHEMATIC DIAGRAM DC2312A-A

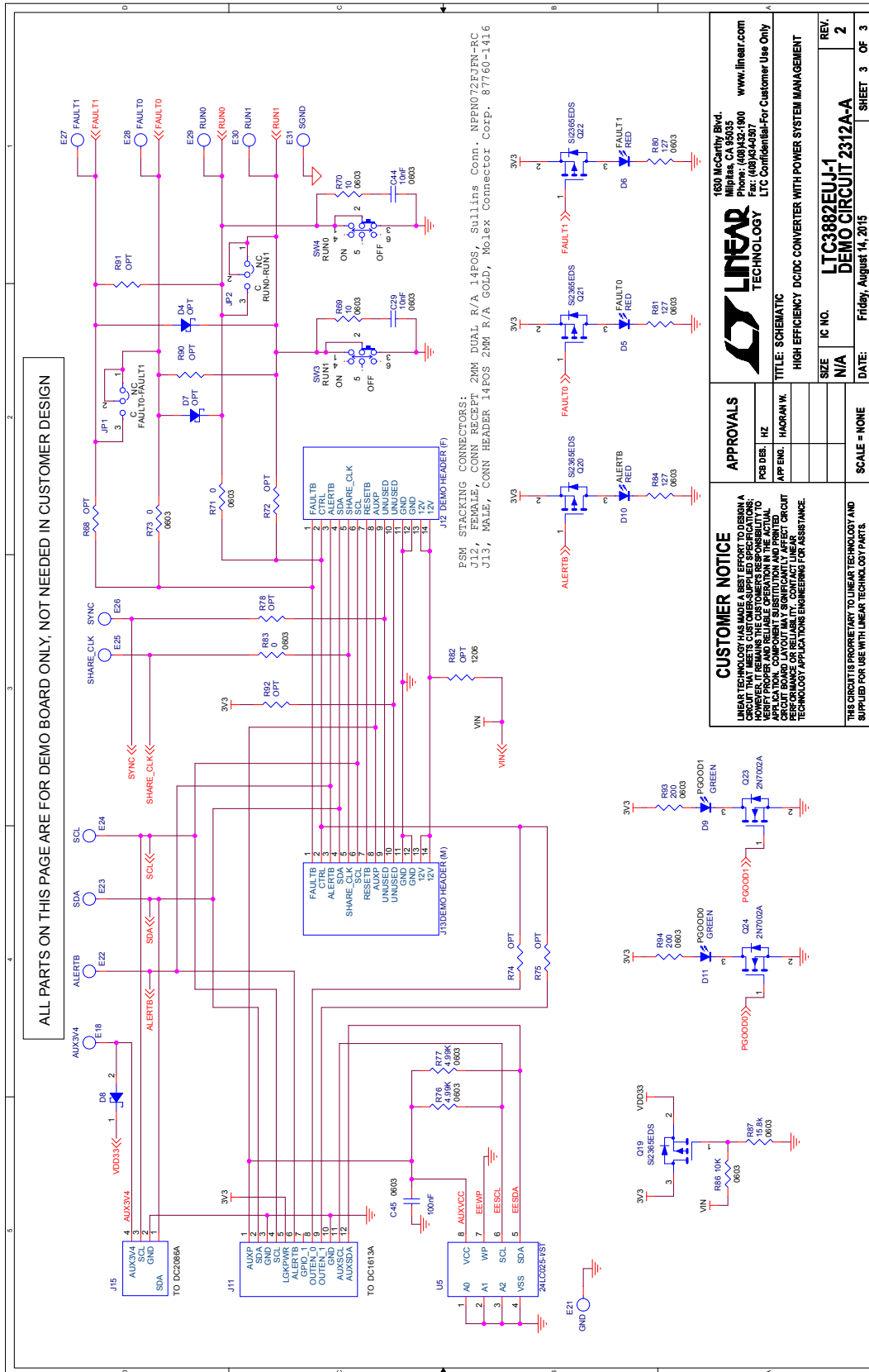

SCHEMATIC DIAGRAM DC2312A-B

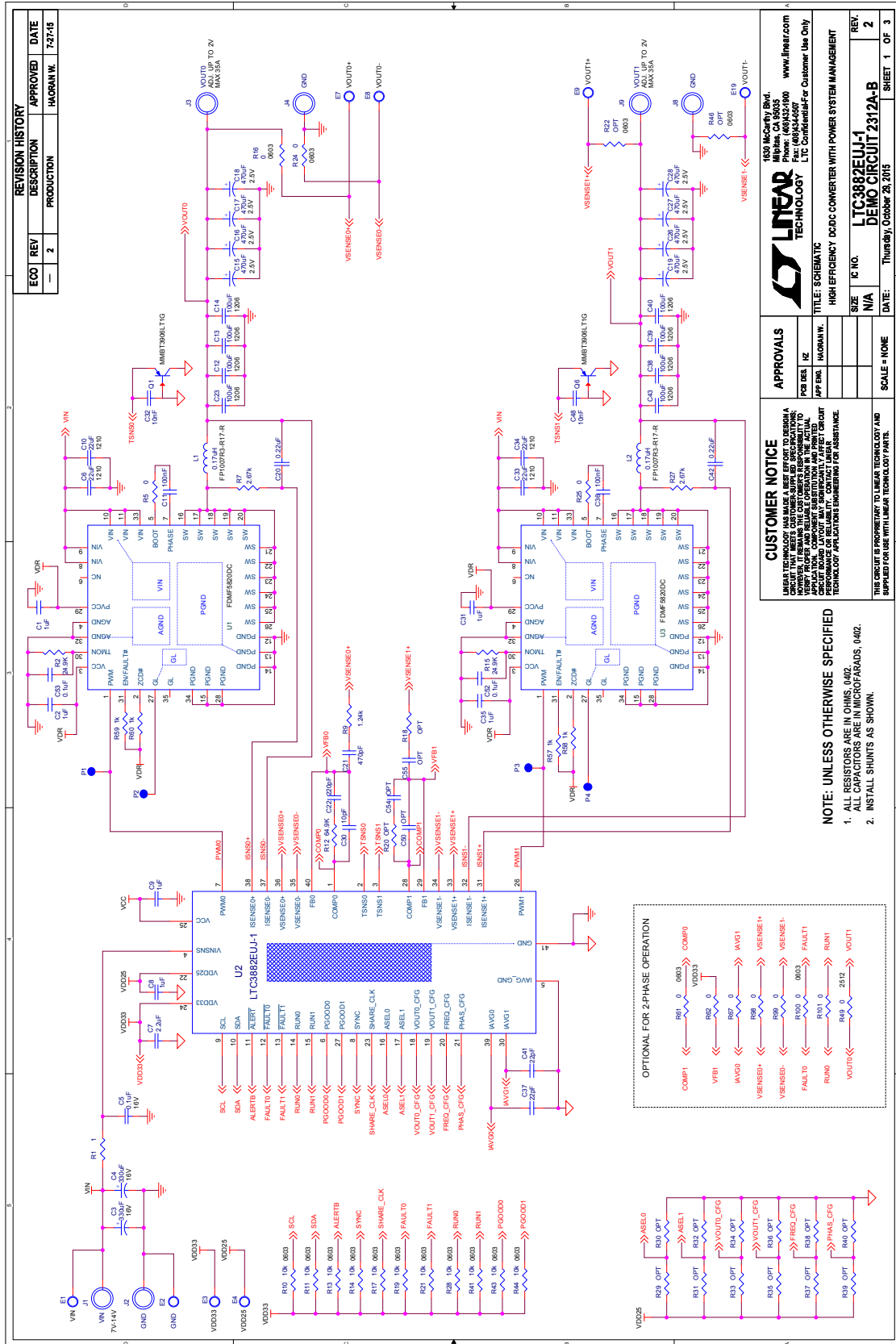

DEMO MANUAL DC2312A-A/DC2312A-B

SCHEMATIC DIAGRAM DC2312A-B

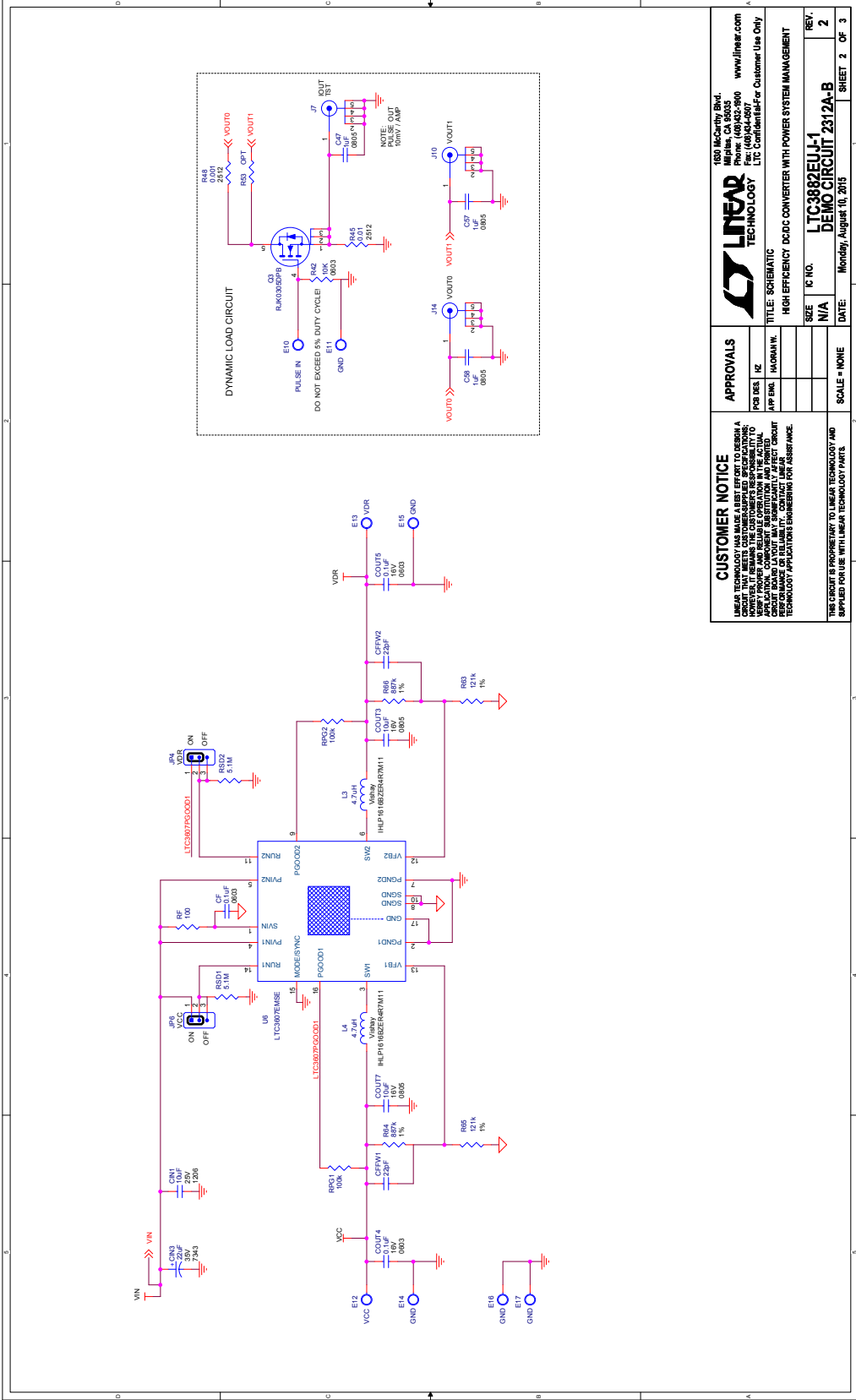

		100 Mcarty Blvd. 100 Mcarty Court Phone: (408)322-2900 Fax: (408)322-4507 LTC Confidential For Customer Use Only	
APPROVALS FOR DES: [] HYP ENR: [] HADRAM W.		TITLE: SCHEMATIC HIGH EFFICIENCY DC/DC CONVERTER WITH POWER SYSTEM MANAGEMENT	
SCALE: NONE	IC NO. LTC3825EUJ-1	DATE: Monday, August 10, 2015	REV: 2
	DEMO CIRCUIT 2312A-B		SHEET 2 OF 3

SCHEMATIC DIAGRAM DC2312A-B

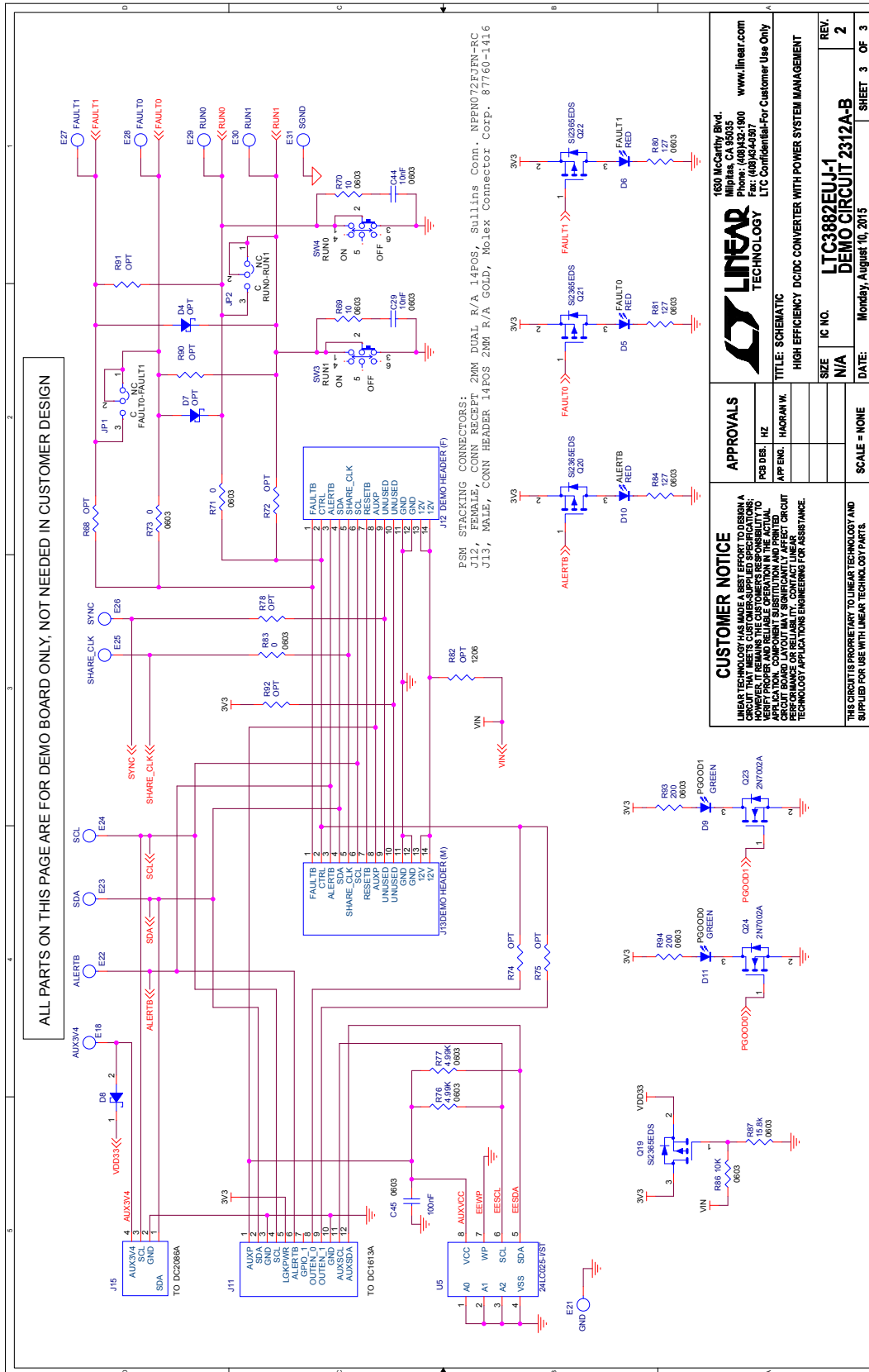

dc2312afb

DEMO MANUAL

DC2312A-A/DC2312A-B

DEMONSTRATION BOARD IMPORTANT NOTICE

Linear Technology Corporation (LTC) provides the enclosed product(s) under the following **AS IS** conditions:

This demonstration board (DEMO BOARD) kit being sold or provided by Linear Technology is intended for use for **ENGINEERING DEVELOPMENT OR EVALUATION PURPOSES ONLY** and is not provided by LTC for commercial use. As such, the DEMO BOARD herein may not be complete in terms of required design-, marketing-, and/or manufacturing-related protective considerations, including but not limited to product safety measures typically found in finished commercial goods. As a prototype, this product does not fall within the scope of the European Union directive on electromagnetic compatibility and therefore may or may not meet the technical requirements of the directive, or other regulations.

If this evaluation kit does not meet the specifications recited in the DEMO BOARD manual the kit may be returned within 30 days from the date of delivery for a full refund. **THE FOREGOING WARRANTY IS THE EXCLUSIVE WARRANTY MADE BY THE SELLER TO BUYER AND IS IN LIEU OF ALL OTHER WARRANTIES, EXPRESSED, IMPLIED, OR STATUTORY, INCLUDING ANY WARRANTY OF MERCHANTABILITY OR FITNESS FOR ANY PARTICULAR PURPOSE. EXCEPT TO THE EXTENT OF THIS INDEMNITY, NEITHER PARTY SHALL BE LIABLE TO THE OTHER FOR ANY INDIRECT, SPECIAL, INCIDENTAL, OR CONSEQUENTIAL DAMAGES.**

The user assumes all responsibility and liability for proper and safe handling of the goods. Further, the user releases LTC from all claims arising from the handling or use of the goods. Due to the open construction of the product, it is the user's responsibility to take any and all appropriate precautions with regard to electrostatic discharge. Also be aware that the products herein may not be regulatory compliant or agency certified (FCC, UL, CE, etc.).

No License is granted under any patent right or other intellectual property whatsoever. **LTC assumes no liability for applications assistance, customer product design, software performance, or infringement of patents or any other intellectual property rights of any kind.**

LTC currently services a variety of customers for products around the world, and therefore this transaction **is not exclusive**.

Please read the DEMO BOARD manual prior to handling the product. Persons handling this product must have electronics training and observe good laboratory practice standards. **Common sense is encouraged.**

This notice contains important safety information about temperatures and voltages. For further safety concerns, please contact a LTC application engineer.

Mailing Address:

Linear Technology
1630 McCarthy Blvd.
Milpitas, CA 95035

Copyright © 2004, Linear Technology Corporation