



User Manual

AIMB-785

**LGA1151 Intel® Core™ i7/i5/i3
ATX with Triple display, Dual
GbE LAN, SATAIII, USB3.0, DDR4**

ADVANTECH

Enabling an Intelligent Planet

Copyright

The documentation and the software included with this product are copyrighted 2017 by Advantech Co., Ltd. All rights are reserved. Advantech Co., Ltd. reserves the right to make improvements in the products described in this manual at any time without notice. No part of this manual may be reproduced, copied, translated or transmitted in any form or by any means without the prior written permission of Advantech Co., Ltd. Information provided in this manual is intended to be accurate and reliable. However, Advantech Co., Ltd. assumes no responsibility for its use, nor for any infringements of the rights of third parties, which may result from its use.

Acknowledgements

AMI is a trademark of American Megatrends Inc.

IBM and PC are trademarks of International Business Machines Corporation.

Intel® Core™, Intel® Core™ 2 Quad, Pentium® Dual Core and Celeron® are trademarks of Intel® Corporation.

WinBond is a trademark of Winbond Corporation.

All other product names or trademarks are properties of their respective owners.

A Message to the Customer

Advantech Customer Services

Each and every Advantech product is built to the most exacting specifications to ensure reliable performance in the harsh and demanding conditions typical of industrial environments. Whether your new Advantech equipment is destined for the laboratory or the factory floor, you can be assured that your product will provide the reliability and ease of operation for which the name Advantech has come to be known.

Your satisfaction is our primary concern. Here is a guide to Advantech's customer services. To ensure you get the full benefit of our services, please follow the instructions below carefully.

Technical Support

We want you to get the maximum performance from your products. So if you run into technical difficulties, we are here to help. For the most frequently asked questions, you can easily find answers in your product documentation. These answers are normally a lot more detailed than the ones we can give over the phone.

So please consult this manual first. If you still cannot find the answer, gather all the information or questions that apply to your problem, and with the product close at hand, call your dealer. Our dealers are well trained and ready to give you the support you need to get the most from your Advantech products. In fact, most problems reported are minor and are able to be easily solved over the phone.

In addition, free technical support is available from Advantech engineers every business day. We are always ready to give advice on application requirements or specific information on the installation and operation of any of our products.

Declaration of Conformity

FCC

This device complies with the requirements in part 15 of the FCC rules:

Operation is subject to the following two conditions:

- This device may not cause harmful interference
- This device must accept any interference received, including interference that may cause undesired operation.

This equipment has been tested and found to comply with the limits for a Class B digital device, pursuant to Part 15 of the FCC Rules. These limits are designed to provide reasonable protection against harmful interference when the equipment is operated in a commercial environment. This equipment generates, uses, and can radiate radio frequency energy and, if not installed and used in accordance with the instruction manual, may cause harmful interference to radio communications. Operation of this device in a residential area is likely to cause harmful interference in which case the user will be required to correct the interference at his/her own expense. The user is advised that any equipment changes or modifications not expressly approved by the party responsible for compliance would void the compliance to FCC regulations and therefore, the user's authority to operate the equipment.

Caution! *There is a danger of a new battery exploding if it is incorrectly installed. Do not attempt to recharge, force open, or heat the battery. Replace the battery only with the same or equivalent type recommended by the manufacturer. Discard used batteries according to the manufacturer's instructions.*



Product Warranty (2 years)

Advantech warrants to you, the original purchaser, that each of its products will be free from defects in materials and workmanship for two years from the date of purchase.

This warranty does not apply to any products which have been repaired or altered by persons other than repair personnel authorized by Advantech, or which have been subject to misuse, abuse, accident or improper installation. Advantech assumes no liability under the terms of this warranty as a consequence of such events.

Because of Advantech's high quality-control standards and rigorous testing, most of our customers never need to use our repair service. If an Advantech product is defective, it will be repaired or replaced at no charge during the warranty period. For out-of-warranty repairs, you will be billed according to the cost of replacement materials, service time and freight. Please consult your dealer for more details.

If you think you have a defective product, follow these steps:

1. Collect all the information about the problem encountered. (For example, CPU speed, Advantech products used, other hardware and software used, etc.) Note anything abnormal and list any onscreen messages you get when the problem occurs.
2. Call your dealer and describe the problem. Please have your manual, product, and any helpful information readily available.
3. If your product is diagnosed as defective, obtain an RMA (return merchandise authorization) number from your dealer. This allows us to process your return more quickly.
4. Carefully pack the defective product, a fully-completed Repair and Replacement Order Card and a photocopy proof of purchase date (such as your sales receipt) in a shippable container. A product returned without proof of the purchase date is not eligible for warranty service.
5. Write the RMA number visibly on the outside of the package and ship it prepaid to your dealer.

Initial Inspection

Before you begin installing your motherboard, please make sure that the following materials have been shipped:

- 1 AIMB-785 Startup Manual
- 1 Driver CD (user's manual is included)
- 2 Serial ATA HDD data cables
- 2 Serial ATA HDD power cables
- 1 I/O port bracket
- 1 Warranty card

If any of these items are missing or damaged, contact your distributor or sales representative immediately. We have carefully inspected the AIMB-785 mechanically and electrically before shipment. It should be free of marks and scratches and in perfect working order upon receipt. As you unpack the AIMB-785, check it for signs of shipping damage. (For example, damaged box, scratches, dents, etc.) If it is damaged or it fails to meet the specifications, notify our service department or your local sales representative immediately. Also notify the carrier. Retain the shipping carton and packing material for inspection by the carrier. After inspection, we will make arrangements to repair or replace the unit.

Contents

Chapter 1 Hardware Configuration.....1

1.1	Introduction	2
1.2	Features	2
1.3	Specifications	3
1.3.1	System	3
1.3.2	Memory	3
1.3.3	Input/Output	3
1.3.4	Graphics.....	4
1.3.5	Ethernet LAN	4
1.3.6	Industrial Features	4
1.3.7	Mechanical and Environmental Specifications.....	4
1.4	Jumpers and Connectors	4
	Table 1.1: Jumper list	4
	Table 1.2: Connectors	5
1.5	Board Layout: Jumper and Connector Locations.....	6
	Figure 1.1 Jumper and Connector Locations.....	6
	Figure 1.2 I/O connectors	7
1.6	AIMB-785 Block Diagram.....	7
	Figure 1.3 AIMB-785 Block Diagram	7
1.7	Safety Precautions	8
1.8	Jumper Settings	8
1.8.1	How to set jumpers	8
1.8.2	CMOS clear & ME clear (JCMOS1 & JME1)	9
	Table 1.3: JCMOS1/JME1	9
1.8.3	Watchdog timer output (JWDT1)	9
	Table 1.4: Watchdog timer output (JWDT1).....	9
	Table 1.5: ATX/AT mode selector (PSON1).....	10
	Table 1.6: JUSB	10
	Table 1.7: JPCICLK1.....	10
1.9	System Memory	11
1.10	Memory Installation Procedures.....	11
1.11	PCI Bus Routing Table.....	11

Chapter 2 Connecting Peripherals13

2.1	Introduction	14
2.2	Parallel Port (LPT1).....	14
2.3	USB Ports and LAN Ports (LAN1_USB910, LAN2_USB12, USB3, USB56, USB78, USB1112 & USB1314)	15
2.4	VGA Connector and DVI-D Connector (DVI1/DVI2 + VGA1).....	16
2.5	Serial Ports (COM1, COM2, COM3, COM4, COM5 & COM6)	16
2.6	External Keyboard & Mouse (KBMS1).....	17
2.7	CPU Fan Connector (CPUFAN1).....	17
2.8	System FAN Connector (SYSFAN1 and SYSFAN2)	18
2.9	Front Panel Connectors (JFP1, JFP2 & JFP3)	18
2.9.1	Power LED and Keyboard Lock (JFP3).....	19
	Table 2.1: PS/2 or ATX power supply LED status.....	19
2.9.2	External Speaker (JFP2 pins 1, 4, 7 & 10).....	19
2.9.3	HDD LED Connector (JFP2 pins 2 & 5).....	19
2.9.4	SNMP SM_Bus connector (JFP2 pins 8 & 11)	19
2.9.5	ATX Soft Power Switch (JFP1 pins 3 & 6).....	19
2.9.6	Reset Connector (JFP1 pins 9 & 12).....	19
2.10	Line Out, Mic In Connector (AUDIO1_AUDIO2)	20
2.11	8-pin Alarm Board Connector (VOLT1).....	20

2.12	Case Open Connector (JCASE1)	21
2.13	Front Panel LAN Indicator Connector (LANLED1).....	21
	Table 2.2: Front Panel LAN Indicator Connector	21
2.14	Serial ATA Interface (SATA0~5).....	22
2.15	PCI Slots (PCI1 ~ PCI3).....	22
2.16	PCIe x16 Expansion Slot (PCIEX16_1)	23
2.17	PCIEX4_1 ~ PCIEX4_3	23
2.18	Auxiliary 4-pin power connector (ATX12V1).....	24
2.19	SPI Flash Connector (SPI_CN1)	24
2.20	Low Pin Count Connector (LPC1).....	25
	Table 2.3: Advantech LPC Module List	25

Chapter 3 BIOS Operation 27

3.1	Introduction	28
	Figure 3.1 Main setup screen	28
3.2	Entering BIOS Setup.....	29
3.2.1	Main Menu.....	29
	Figure 3.2 Main setup screen	29
3.2.2	Advanced BIOS Features Setup.....	30
	Figure 3.3 Advanced BIOS features setup screen	30
	Figure 3.4 Platform Misc Configuration	31
	Figure 3.5 CPU Configuration	32
	Figure 3.6 PCH-FW Configuration.....	34
	Figure 3.7 AMT Configuration	35
	Figure 3.8 CIRA Configuration	35
	Figure 3.9 ASF Configuration	36
	Figure 3.10 Secure Erase Configuration	37
	Figure 3.11 OEM Flags Settings	37
	Figure 3.12 MEBx Resolution Settings.....	38
	Figure 3.13 TPM Settings.....	39
	Figure 3.14 ACPI Settings.....	40
	Figure 3.15 SMART Settings.....	41
	Figure 3.16 Super IO Configuration.....	42
	Figure 3.17 Serial Port 1 Configuration	42
	Figure 3.18 Serial Port 2 Configuration	43
	Figure 3.19 Parallel Configuration	43
	Figure 3.20 PC Health Status.....	44
	Figure 3.21 Super IO Configuration.....	45
	Figure 3.22 Serial Port 3 Configuration	46
	Figure 3.23 Serial Port 4 Configuration	47
	Figure 3.24 Serial Port 5 Configuration	47
	Figure 3.25 Serial Port 6 Configuration	48
	Figure 3.26 S5 RTC Wake Settings	49
	Figure 3.27 Serial Port Console Redirection	50
	Figure 3.28 Intel TXT Information.....	51
	Figure 3.29 PCI Subsystem Settings.....	51
	Figure 3.30 CSM Configuration	52
	Figure 3.31 USB Configuration.....	53
3.2.3	Chipset.....	54
	Figure 3.32 Chipset	54
	Figure 3.33 System Agent (SA) Configuration	54
	Figure 3.34 Graphics Configuration.....	55
	Figure 3.35 LCD Control.....	56
	Figure 3.36 PEG Port Configuration.....	57
	Figure 3.37 PEG Port Feature Configuration	57
	Figure 3.38 Memory Configuration	58
	Figure 3.39 PCH-IO Configuration	59
	Figure 3.40 SATA Configuration.....	62

3.2.4	Security	64
	Figure 3.41 Security	64
3.2.5	Boot	65
	Figure 3.42 Boot	65
3.2.6	Save & Exit	66
	Figure 3.43 Save & Exit	66
Chapter 4	Chipset Software Installation Utility	67
4.1	Before you begin	68
4.2	Introduction	68
4.3	Windows 10 / Windows 8.1 / Windows 7 Driver Setup	69
Chapter 5	Integrated Graphic Device Setup	71
5.1	Introduction	72
5.2	Windows 10/Windows 8.1/Windows 7 Driver Setup	72
Chapter 6	LAN Configuration	73
6.1	Introduction	74
6.2	Features	74
6.3	Installation	74
6.4	Win 10/Win 8.1/Win 7 Driver Setup (LAN)	74
Chapter 7	Intel ME	75
7.1	Introduction	76
7.2	Installation	76
Chapter 8	Intel USB 3.0	77
8.1	Introduction	78
8.2	Installation	78
Chapter 9	SATA RAID Setup	79
9.1	Introduction	80
9.2	SATA RAID Driver and Utility Setup	80
Chapter 10	HD Audio	81
10.1	Introduction	82
10.2	Installation	82
Appendix A	Programming the Watchdog Timer	83
A.1	Watchdog timer overview	84
A.2	Programming the Watchdog Timer	84
	Table A.1: Watchdog timer registers	86
A.2.1	Example Programs	86

Appendix B I/O Pin Assignments 91

B.1	Parallel Port (LPT1)	92
	Table B.1: Parallel Port (LPT1).....	92
B.2	USB2.0 Type A Port (USB3).....	92
	Table B.2: USB2.0 Type A Port (USB3)	92
B.3	USB3.0 Header (USB1314).....	93
B.4	USB2.0 Header (USB56, USB78, USB1112).....	93
	Table B.3: USB2.0 Header (USB56, USB78, USB1112).....	93
B.5	VGA Connector (VGA1).....	94
	Table B.4: VGA Connector (VGA1)	94
B.6	DVI Interface.....	94
	Table B.5: DVI-D Connector (DVI1/DVI2).....	94
B.7	RS-232 and COM3 Interface	95
	Table B.6: RS-232 Interface (Rear).....	95
	Table B.7: RS-232 Interface (onboard).....	95
	Table B.8: COM3 Interface (onboard)	95
B.8	External Keyboard and Mouse Connector (KBMS1)	96
	Table B.9: External Keyboard and Mouse Connector (KBMS2)	96
B.9	Infrared (IR) connector (JIR1) and JWDT1 and HW Monitor Alarm (JOBS1) 96	
	Table B.10:JIR1+JWDT1+JOBS1	96
B.10	System Fan Power Connector (SYSFAN1/SYSFAN2).....	96
	Table B.11:Fan Power Connector (SYSFAN1/SYSFAN2)	96
B.11	Power LED and Keyboard Lock (JFP3).....	97
	Table B.12:Power LED and Keyboard Lock (JFP3)	97
B.12	External Speaker Connector (JFP2).....	97
	Table B.13:External Speaker Connector (JFP2)	97
B.13	Reset Connector (JFP1)	97
	Table B.14:Reset Connector (JFP1).....	97
B.14	HDD LED Connector (JFP2).....	98
	Table B.15:HDD LED Connector (JFP2)	98
B.15	ATX Soft Power Switch (JFP1).....	98
	Table B.16:ATX Soft Power Switch (JFP1)	98
B.16	SNMP SM_BUS Bus Connector (JFP2)	98
	Table B.17:SM Bus Connector (JFP2)	98
B.17	USB/LAN ports (LAN1_USB910 and LAN2_USB12)	99
	Table B.18:USB2.0 Port	99
	Table B.19:USB3.0 Port	99
	Table B.20:Giga LAN 10/100/1000 Base-T RJ-45 port	99
B.18	Line Out, MIC IN Connector (AUDIO).....	99
B.19	Front Panel Audio Connector (FPAUD1).....	100
	Table B.21:Front Panel Audio Connector (FPAUD1)	100
B.20	8-pin Alarm Board Connector (VOLT1).....	100
	Table B.22:8-pin Alarm Board Connector (VOLT1)	100
B.21	Case Open Connector (JCASE1)	101
	Table B.23:Case Open Connector (JCASE1).....	101
B.22	Front Panel LAN LED Connector (LAN_LED1)	101
	Table B.24:LAN LED Connector (LANLED1)	101
B.23	SPI_CN1: SPI Flash Card Pin Connector.....	101
	Table B.25:SPI_CN1:SPI fresh card pin connector	101
B.24	Fixed I/O Ranges Decoded by Intel PCH	102
	Table B.26:Fixed I/O Ranges Decoded by PCH.....	102
B.25	System I/O Ports.....	104
B.26	DMA Channel Assignments	104
	Table B.27:DMA channel assignments.....	104
B.27	Interrupt Assignments	105
	Table B.28:Interrupt assignments.....	105
B.28	1st MB Memory Map.....	105
	Table B.29:1st MB memory map	105

Chapter 1

Hardware
Configuration

1.1 Introduction

AIMB-785 motherboard is the most advanced Intel Q170 board for industrial applications that require high-performance computing. The motherboard supports 6th and 7th generation Intel Core i7/i5/i3 and DDR4 1866/2133 MHz memory up to 64 GB. AIMB-785 provides cost-effective integrated graphics with 1 GB VRAM max shared memory and 2 GB or above system memory installed.

AIMB-785 provides triple display interfaces. Users can use the onboard VGA and the other DVI ports at the same time. In addition, the AIMB-785 has dual Gigabit Ethernet LAN via dedicated PCIe x1 bus, which offers bandwidth of up to 500 MB/s, eliminating network bottlenecks. High reliability and outstanding performance make the AIMB-785 the ideal platform for industrial networking applications.

By using the Intel Q170 chipset, the AIMB-785 offers three 32-bit, 33 MHz PCI slots; three PCIe x4 slot, one PCIe x16 slot and a variety of features such as 4 x onboard SATA III interfaces (bandwidth = 600 MB/s) with software RAID (another two SATA ports SATA0 and SAT1 from Marvell controller do not support software RAID); 6 x USB 3.0 and 7 x USB 2.0 connectors and HD Audio. These powerful I/O capabilities ensure even more reliable data storage capabilities and high-speed I/O peripheral connectivity.

The AIMB-785 also adopts Advantech's unique patented Sleep Mode Control Circuit for AT Power Mode. With all the excellent features and outstanding performance, the AIMB-785 is the ideal platform for today's industrial applications.

1.2 Features

- **PCIe architecture:** The Intel Q170 PCH chipset supports 1 PCIe x16 slot, 3 PCIe x4 slot.
- **High Performance I/O capability:** Dual Gigabit LAN via PCIe x1 bus, 3 PCI 32-bit/33MHz PCI slots, 6 SATA III (software RAID support for SATA2~5 ports only), 6 USB 3.0, 7 SUB 2.0.
- **Standard ATX form factor with industrial features:** AIMB-785 provides industrial features like long product life, reliable operation under wide temperature range, watchdog timer functions, etc.
- **Support DDR4 1866/2133 up to 64 GB:** DDR4 provides up to 50 percent increased performance and bandwidth while saving up to 40 percent power.
- **SUSI API:** AIMB-785 supports SUSI 4.0 API which helps customer to develop their own remote management programs under Windows 7 and Windows 8.1.

1.3 Specifications

1.3.1 System

- CPU: LGA1151-socket Core i7/i5/i3, Pentium and Celeron processor.
- L3 Cache: Please refer to CPU specification for detailed information.
- BIOS: AMI SPI BIOS (128Mbit)
- System Chipset: Q170
- SATA Hard Disk Drive Interface: AIMB-785 supports six SATA III ports. SATA2-SATA5 provides RAID functions (RAID 0, 1, 5, 10).

Note! *The Intel 7th generation processors only support Windows 10 (64-bit).*



1.3.2 Memory

- **RAM:** Up to 64 GB in four 288-pin DIMM sockets. Supports dual-channel DDR4 1866/2133 SDRAM.
 - AIMB-785: supports non-ECC unbuffered DIMMs and do not support any memory configuration that mixes non-ECC with ECC unbuffered DIMMs

Note! *A 32-bit OS may not fully detect 4 GB of RAM when 4 GB is installed.*



1.3.3 Input/Output

- **PCIe slot:** 1 PCIe x16 expansion slot, 3 PCIe x4 expansion slot.
- **PCI Bus:** 3 PCI slots, 32-bit, 33 MHz PCI 2.2 compliant.
- **Enhanced parallel port:** Configured to LPT1 or disabled. Standard DB-25 female connector cable is a optional accessory. Because Intel Q170 do not offer LPC DMA function, the parallel port only supports SPP/EPP.
- **Serial port:** Six serial ports, one is RS-232/422/485 with hardware auto-flow control and four are RS-232. One DB-9 connector with RS-232 located in rear panel.
- **USB port:** Supports 6 USB 3.0 ports on front/rear I/O, 6 USB 2.0 ports with wafer box, and 1 USB 2.0 port with type A connector. rates up to 5 Gb/s.
- **LPC:** One LPC connector to support Advantech LPC modules, including PCA-COM232-00A1E, PCA-COM485-00A1E, and PCA-TPM-00A1E.
- **GPIO:** AIMB-785 supports 8-bit GPIO from super I/O for general purpose control application.

Note! *AIMB-785 do not support PS/2 connector for PS/2 key board/ mouse. Please use the USB ports in rear I/O.*



1.3.4 Graphics

- **Controller:**
- **Display memory:** Shared memory is subject to OS (install 2 GB or above memory for basic system configuration).
- **Triple display:** 1 VGA (DB-15) +2 DVI-D in rear I/O.
- **DVI-D:** Up to resolution 1920 x 1200 @ 60 Hz refresh rate
- **VGA:** Up to 1920 x 1200 resolution @ 60 Hz refresh rate

1.3.5 Ethernet LAN

- Supports dual 10/100/1000Base-T Ethernet port (s) via PCIe x1 bus which provides a 500 MB/s data transmission rate.
- **Interface:** 10/100/1000Base-T
- **Controller:** Intel I219LM(PHY) for LAN1, Intel I211AT for LAN2

1.3.6 Industrial Features

- **Watchdog timer:** Can generate system reset or NC. The watchdog timer is programmable, with each unit equal to one second (255 levels)

1.3.7 Mechanical and Environmental Specifications

- **Operating temperature:** 0 ~ 60°C (32 ~ 140° F, depending on CPU)
- **Storage temperature:** -20 ~ 70° C (-4 ~ 158° F)
- **Humidity:** 5 ~ 95% non-condensing
- **Power supply voltage:** +3.3 V, +5 V, ±12 V, +5 VSB
- **Power consumption:** Intel Core i7-6700 3.4 GHz; DDR4 8 G x 4
Maximum: +3.3 V at 1.02 A, +5 V at 1.96 A, +12 V at 1.14 A, +5 Vsb at 0.08 A, -5 V at 0.03 A, -12 V at 0.06 A
- **Board size:** 304.8 x 228.6 mm (12" x 9.6")
- **Board weight:**

1.4 Jumpers and Connectors

Connectors on the AIMB-785 motherboard link it to external devices such as hard disk drives and a keyboard. In addition, the board has a number of jumpers that are used to configure your system for your application.

The tables below list the function of each of the jumpers and connectors. Later sections in this chapter give instructions on setting jumpers. Chapter 2 gives instructions for connecting external devices to your motherboard.

Table 1.1: Jumper list

Label	Function
JCMOS1	CMOS Clear
JWDT1	Watchdog reset
PSON1	AT(1-2) / ATX(2-3) mode selector
JUSB_1	USB power source switch between +5 V and +5 V_ DUAL for Rear USB ports
JUSB_2	USB power source switch between +5 V and +5 V_ DUAL for On Board USB ports
JPCICLK1	PCI Clock selection (1-2): 66MHz/ (2-3): 33MHz (default)

Table 1.2: Connectors

Label	Function
LPT1	Parallel port, supports SPP/EPP mode
LAN1_USB12	LAN1/ USB3.0 1,2
LAN2_USB34	LAN2/ USB3.0 3,4
VGA1+COM1	VGA connector / COM connector
DVI1+DVI2	Dual DVI-D connectors
COM 1~2 and 4~6	Serial port: RS-232
COM3	Serial port: RS-232/422/485 (9-pin connector)
KBMS1	External keyboard and mouse connector (6-pin)
JFP3	Keyboard lock and power LED
	Suspend: fast flash (ATX/AT)
	System On: on (ATX/AT)
	System Off: off (AT/ATX)
JFP2	External speaker / HDD LED connector / SM Bus connector
JFP1	Power switch / reset connector
JCASE1	Case open connector
VOLT1	Alarm Board Power connector
JOBS1	HW monitor
	Close: enable OBS alarm
	Open: disable OBS alarm
CPUFAN1	CPU fan connector (4-pin)
SYSFAN1	System fan connector (4-pin)
SYSFAN2	System fan connector (4-pin)
LANLED1	Front Panel LAN indicator connector
AUDIO1	Audio connector (Line-out, Mic-in)
FPAUD1	Front Panel Audio pin header
USB3	USB port 3 (Type A)
USB56	USB port 5, 6
USB78	USB port 7, 8
USB910	USB port 9,10
USB11	USB port 11
USB1314	USB 3.0 port 13,14
SATA0	Serial ATA1
SATA1	Serial ATA2
SATA2	Serial ATA3
SATA3	Serial ATA4
SATA4	Serial ATA5
SATA5	Serial ATA6
ATX12V1	ATX 12 V auxiliary power connector (for CPU)
EATXPWR1	ATX 24-pin main power connector (for system)
PCIEX16_1	PCIe x16 slot 1
PCIEX4_1	PCIe x4 slot 1
PCIEX4_2	PCIe x4 slot 2
PCIEX4_3	PCIe x4 slot 3
PCI1	PCI slot 1
PCI2	PCI slot 2

Table 1.2: Connectors

PCI3	PCI slot 3
DIMMA1	Channel A DIMM1
DIMMA2	Channel A DIMM2
DIMMB1	Channel B DIMM1
DIMMB2	Channel B DIMM2
SPI_CN1	Update BIOS pin header
SPDIF_OUT1	SPDIF Audio out pin header
JME1	Intel ME enable/disable
GPIO1	8 bit GPIO from super I/O
SMBUS1	SM Bus from PCH
LPC1	Low pin count connector

1.5 Board Layout: Jumper and Connector Locations

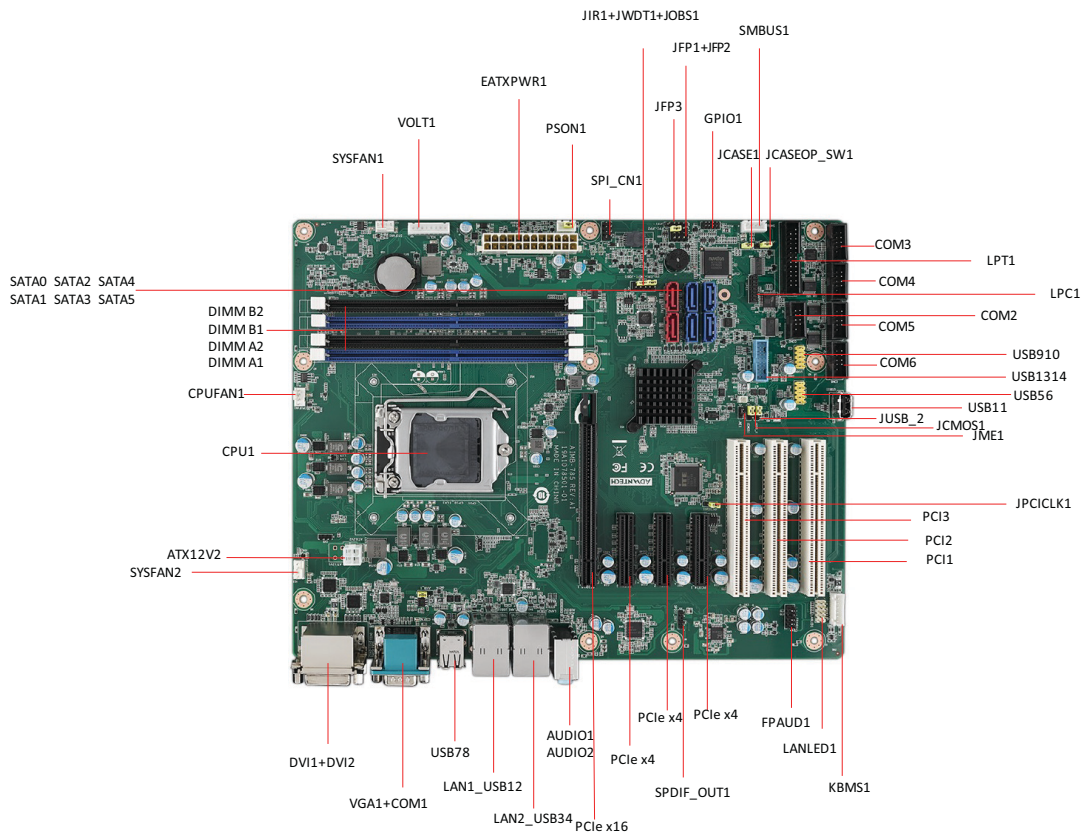

Figure 1.1 Jumper and Connector Locations



Figure 1.2 I/O connectors

1.6 AIMB-785 Block Diagram

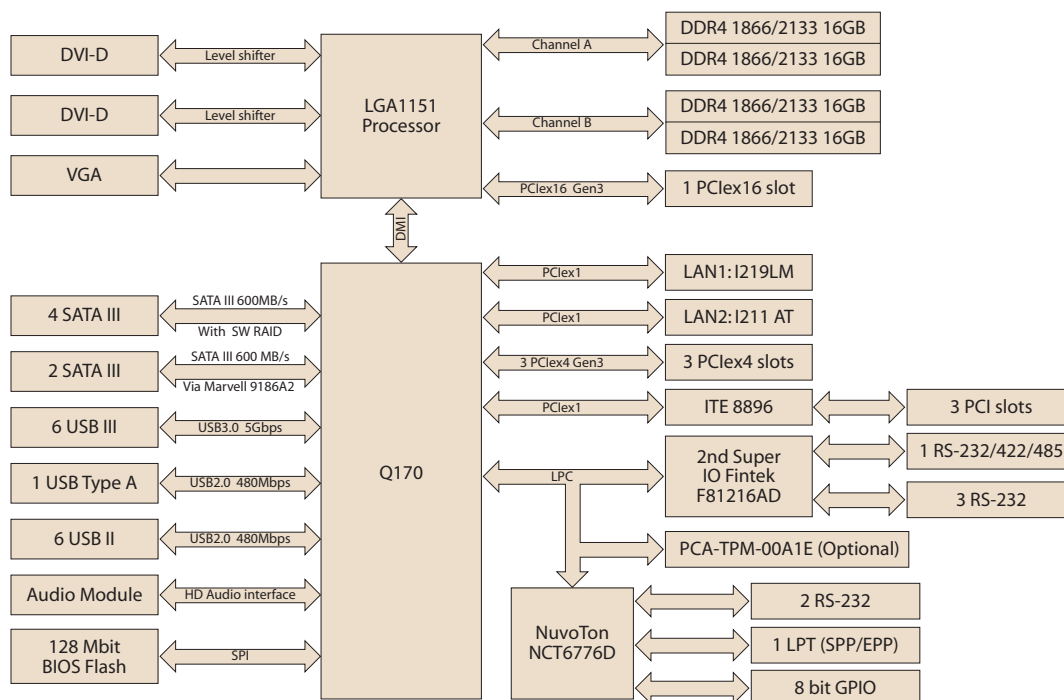

Figure 1.3 AIMB-785 Block Diagram

1.7 Safety Precautions

Warning! *Always completely disconnect the power cord from your chassis whenever you work with the hardware. Do not make connections while the power is on. Sensitive electronic components can be damaged by sudden power surges. Only experienced electronics personnel should open the PC chassis.*



Caution! *Always ground yourself to remove any static charge before touching the motherboard. Modern electronic devices are very sensitive to static electric discharges. As a safety precaution, use a grounding wrist strap at all times. Place all electronic components on a static-dissipative surface or in a static-shielded bag when they are not in the chassis.*



Caution! *The computer is provided with a battery-powered Real-time Clock circuit. There is a danger of explosion if battery is incorrectly replaced. Replace only with same or equivalent type recommended by the manufacturer. Discard used batteries according to manufacturer's instructions.*



Caution! *There is a danger of a new battery exploding if it is incorrectly installed. Do not attempt to recharge, force open, or heat the battery. Replace the battery only with the same or equivalent type recommended by the manufacturer. Discard used batteries according to the manufacturer's instructions.*



1.8 Jumper Settings

This section provides instructions on how to configure your motherboard by setting the jumpers. It also includes the motherboard default settings and your options for each jumper.

1.8.1 How to set jumpers

You can configure your motherboard to match the needs of your application by setting the jumpers. A jumper is a metal bridge that closes an electrical circuit. It consists of two metal pins and a small metal clip (often protected by a plastic cover) that slides over the pins to connect them. To “close” (or turn on) a jumper, you connect the pins with the clip. To “open” (or turn off) a jumper, you remove the clip. Sometimes a jumper consists of a set of three pins, labeled 1, 2, and 3. In this case you connect either pins 1 and 2, or 2 and 3. A pair of needle-nose pliers may be useful when setting jumpers.

1.8.2 CMOS clear & ME clear (JCMOS1 & JME1)

The AIMB-785 motherboard contains a jumper that can erase CMOS data and reset the system BIOS information. Normally this jumper should be set with pins 1-2 closed. If you want to reset the CMOS data, set J1 to 2-3 closed for just a few seconds, and then move the jumper back to 1-2 closed. This procedure will reset the CMOS to its default setting.

Table 1.3: JCMOS1/JME1

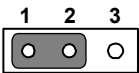
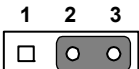
Function	Jumper Setting
* Keep CMOS and ME data	 1-2 closed
Clear CMOS and ME data	 2-3 closed
* default setting	

1.8.3 Watchdog timer output (JWDT1)

The AIMB-785 contains a watchdog timer that will reset the CPU. This feature means the AIMB-785 will recover from a software failure or an EMI problem. The JWDT1 jumper settings control the outcome of what the computer will do in the event the watchdog timer is tripped.

Table 1.4: Watchdog timer output (JWDT1)

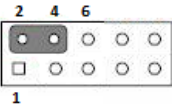
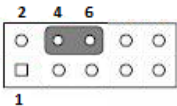
Function	Jumper Setting
NC	 2-4 closed
* Reset	 4-6 closed
* default setting	

Note! *The interrupt output of the watchdog timer is a low level signal. It will be held low until the watchdog timer is reset.*



Table 1.5: ATX/AT mode selector (PSON1)

Function	Jumper Setting
AT Mode	 1-2 closed
* ATX Mode	 2-3 closed
* default setting	

Table 1.6: JUSB

Function	Jumper Setting
*USB +5 V_DUAL Power	 1-2 closed
USB +5 V Power	 2-3 closed
* default setting	

AIMB-785 allows users to set USB power between +5 V_DUAL and +5 V. When the jumper is set as +5 V, the board doesn't support wake up from S3 via keyboard or mouse.

Note! When USB power is switched to +5 V, it can't be connected with powered KVM.

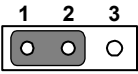
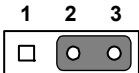
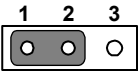
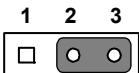

Table 1.7: JPCICLK1

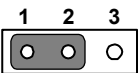
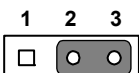
Function	Jumper Setting
66 MHz	 1-2 closed
*33 MHz	 2-3 closed
* default setting	

1.9 System Memory

AIMB-785 has four 288-pin memory sockets for DDR4 1866/2133 MHz memory modules with maximum capacity of 64 GB (Maximum 16 GB for each DIMM). AIMB-785 only supports non-ECC DDR4 memory modules.

Please note that AIMB-785 does NOT support registered DIMMs (RDIMMs).

Note! *Because AIMB-785 supports Intel Active Management Technology 11 (iAMT11) which utilizes some memory space of channel 0, it's suggested that the user installs at least one memory module on channel 0 DIMM slot (DIMMA1 or DIMMA2), or it may cause some system abnormality.*



1.10 Memory Installation Procedures

To install DIMMs, first make sure the two handles of the DIMM socket are in the “open” position. i.e. The handles lean outward. Slowly slide the DIMM module along the plastic guides on both ends of the socket, and then press the DIMM module right down into the socket, until you hear a click. This is when the two handles have automatically locked the memory module into the correct position of the DIMM socket. To remove the memory module, just push both handles outward, and the memory module will be ejected by the mechanism in the socket.

1.11 PCI Bus Routing Table

AD PCI slot INT	PCI1	PCI2	PCI3	PCI4
	AD16	AD21	AD22	AD28
A	A	F	G	H
B	B	G	H	E
C	C	H	E	F
D	D	E	F	G

Chapter 2

Connecting
Peripherals

2.1 Introduction

You can access most of the connectors from the top of the board as it is being installed in the chassis. If you have a number of cards installed, you may need to partially remove a card to make all the connections.

2.2 Parallel Port (LPT1)

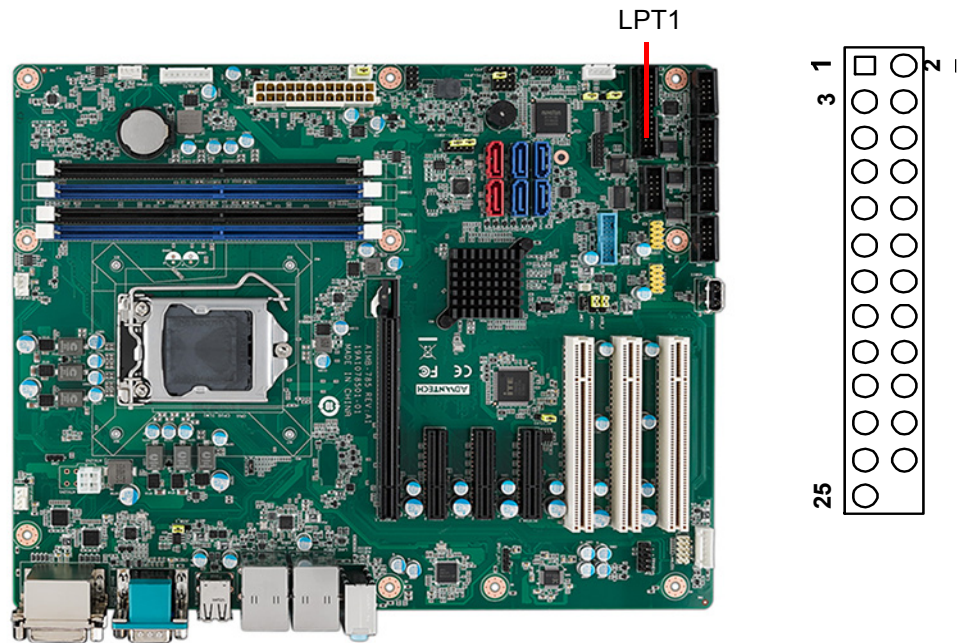

The parallel port is normally used to connect the motherboard to a printer. The AIMB-785 includes an onboard parallel port, accessed through a 25-pin flat-cable connector, LPT1.

2.3 USB Ports and LAN Ports (LAN1_USB910, LAN2_USB12, USB3, USB56, USB78, USB1112 & USB1314)

Ports support Plug & Play and hot swapping for up to 127 external devices. The USB 1/2/3/4/13/14 ports comply up to USB specification rev. 3.0. Transmission rates of up to 5 Gb/s and fuse protection are supported. The USB interface can be disabled in the system BIOS setup.

The AIMB-785 is equipped with two high-performance 1000 Mbps Ethernet LANs. They are supported by all major network operating systems. The RJ-45 jacks on the rear plate provide convenient 1000Base-T operation.

If all USB ports are used, USB power is recommended to switch to +5 V instead of +5 V_DUAL.

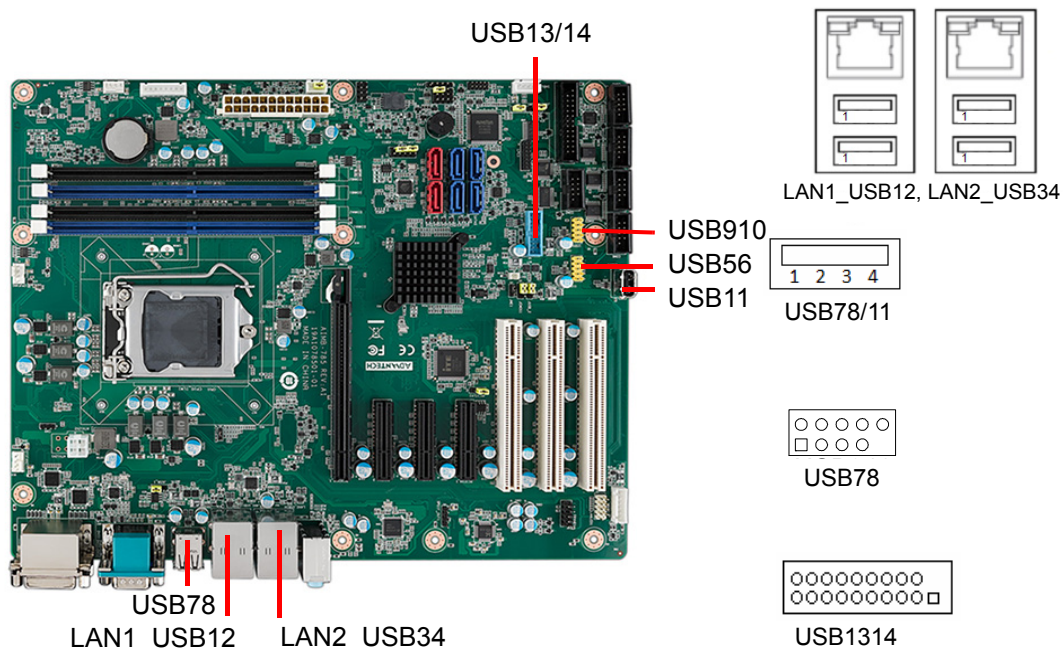

2.4 VGA Connector and DVI-D Connector (DVI1/ DVI2 + VGA1)

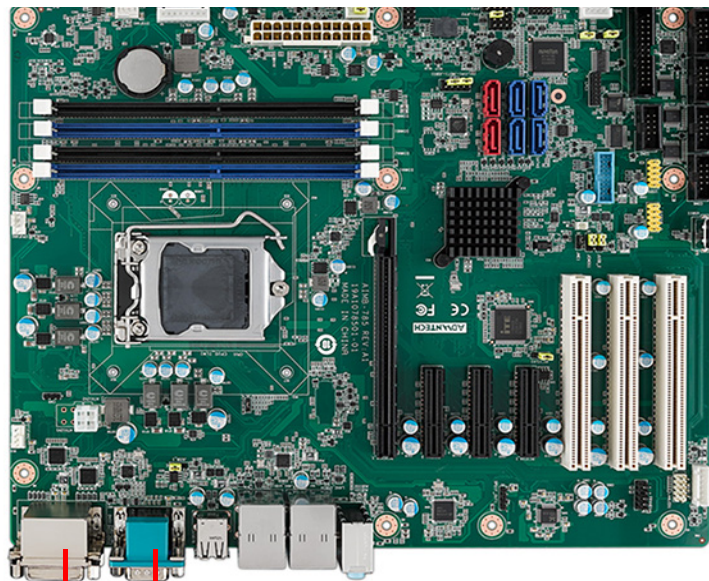

DVI1
DVI2
VGA1
COM1

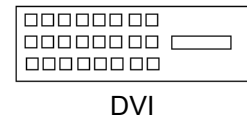
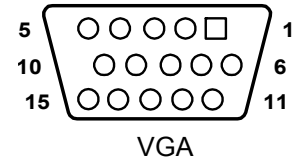

The AIMB-785 includes both VGA and DVI-D interface that can drive conventional CRT and LCD displays. Pin assignments of VGA1 and DVI1/DVI2 are detailed in Appendix B.

2.5 Serial Ports (COM1, COM2, COM3, COM4, COM5 & COM6)

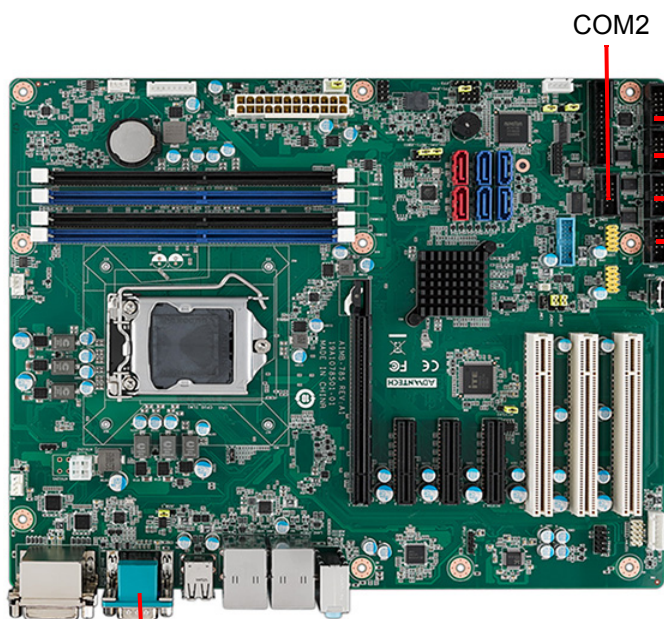

VGA1+COM1

COM2

COM3
COM4
COM5
COM6

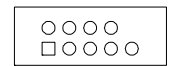
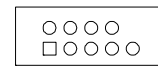
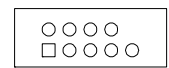
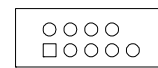
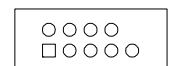
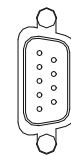

The AIMB-785 offers six serial ports (one on the rear panel and five onboard). RS-232/422/485 mode is selected by BIOS for COM3. These ports can connect to a serial mouse, printer or communications network. The IRQ and address ranges for

those ports are fixed. However, if you want to disable the port or change these parameters later, you can do this in the system BIOS setup. Different devices implement the RS-232/422/485 standards in different ways. If you are having problems with a serial device, please be sure to check the pin assignments for the connector.

2.6 External Keyboard & Mouse (KBMS1)

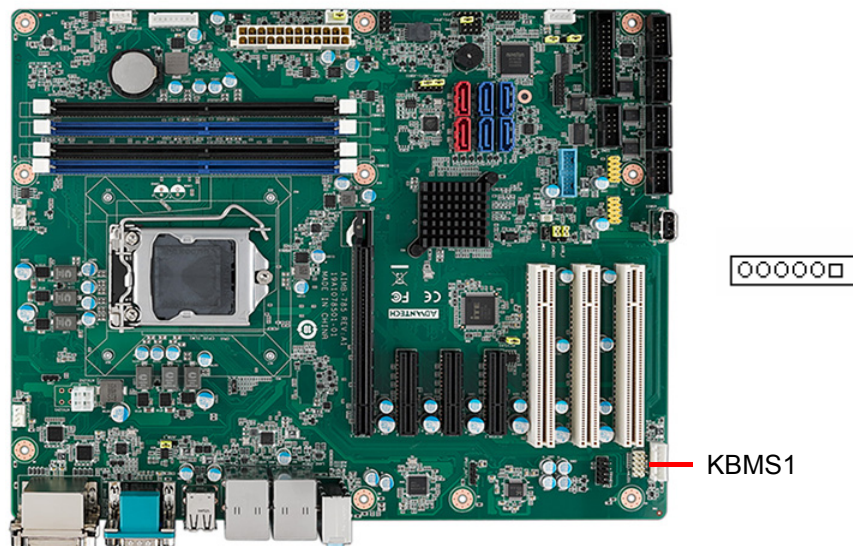

There is also an extra onboard external keyboard and mouse connector on the motherboard. This gives system integrators greater flexibility in designing their systems.

2.7 CPU Fan Connector (CPUFAN1)

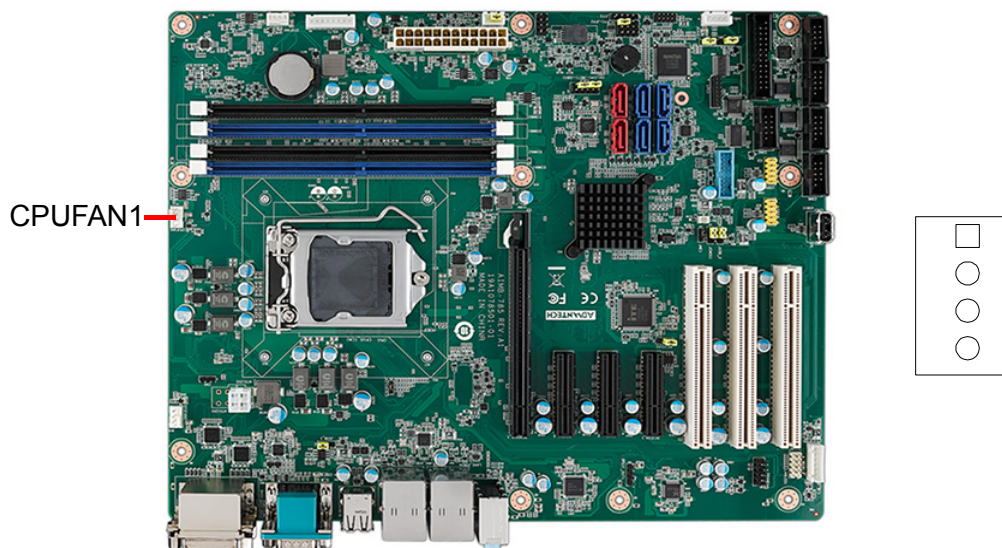

If a fan is used, this connector supports cooling fans that draw up to 500 mA (6 W).

2.8 System FAN Connector (SYSFAN1 and SYSFAN2)

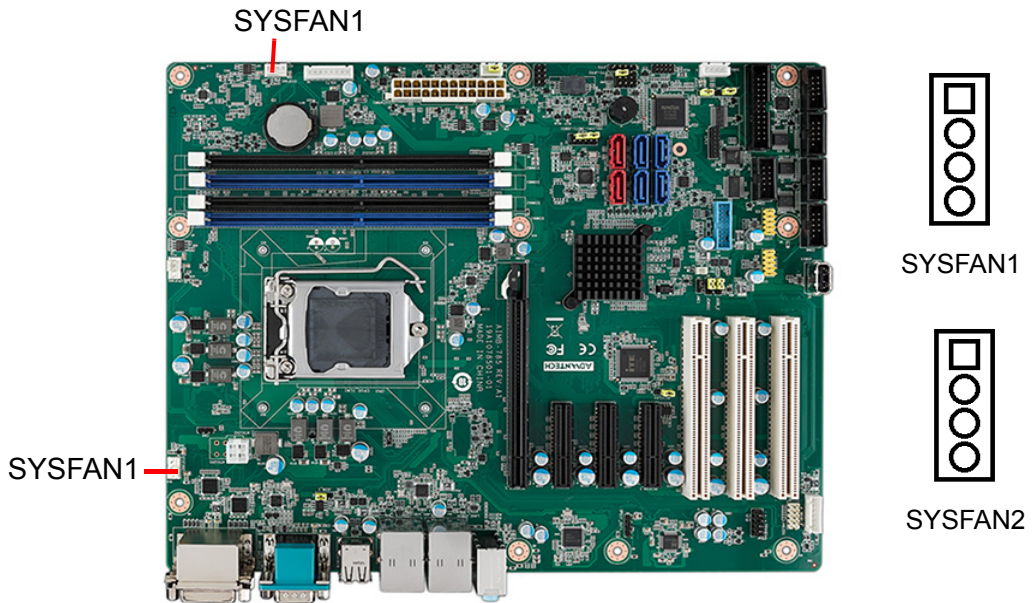

If a fan is used, this connector supports cooling fans that draw up to 500 mA (6 W).

2.9 Front Panel Connectors (JFP1, JFP2 & JFP3)

There are several external switches and LEDs to monitor and control the AIMB-785.

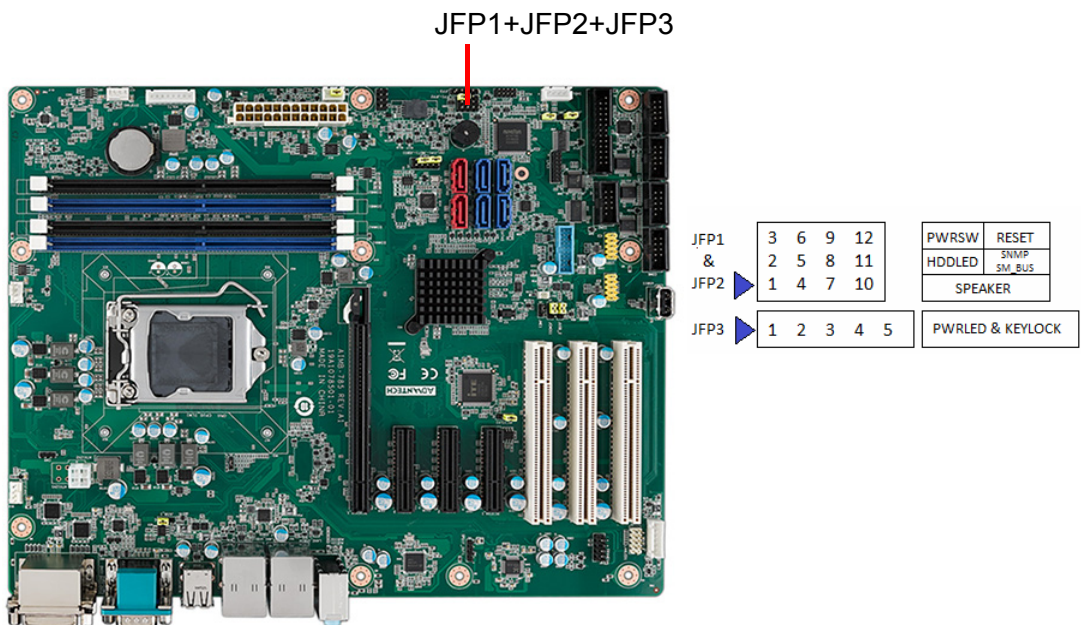

2.9.1 Power LED and Keyboard Lock (JFP3)

JFP3 is a 5-pin connector for the power LED and keyboard lock. Refer to Appendix B for detailed information on the pin assignments. If a PS/2 or ATX power supply is used, the system's power LED status will be as indicated as follows.

Table 2.1: PS/2 or ATX power supply LED status

Power mode	LED (PS/2 power)	LED (ATX power)
System On	On	On
System Suspend	Fast flashes	Fast flashes
System Off	Off	Off
System Off in deep sleep	Off	Off

2.9.2 External Speaker (JFP2 pins 1, 4, 7 & 10)

JFP2 is a 8-pin connector for an external speaker. The AIMB-785 provides an onboard buzzer as an alternative. To enable the buzzer, set pins 7-10 as closed.

2.9.3 HDD LED Connector (JFP2 pins 2 & 5)

You can connect an LED to connector JFP2 to indicate when the HDD is active.

2.9.4 SNMP SM_Bus connector (JFP2 pins 8 & 11)

AIMB-785 supports Advantech SNMP-1000/SAB-2000 module for providing a platform independent system management. When installing SNMP-1000/SAB-2000 module on AIMB-785, please connect it to pins 8 and 11 of JFP2.

2.9.5 ATX Soft Power Switch (JFP1 pins 3 & 6)

If your computer case is equipped with an ATX power supply, you should connect the power on/off button on your computer case to pins 3 and 6 of JFP1. This connection enables you to turn your computer on and off.

2.9.6 Reset Connector (JFP1 pins 9 & 12)

Many computer cases offer the convenience of a reset button.

2.10 Line Out, Mic In Connector (AUDIO1_AUDIO2)

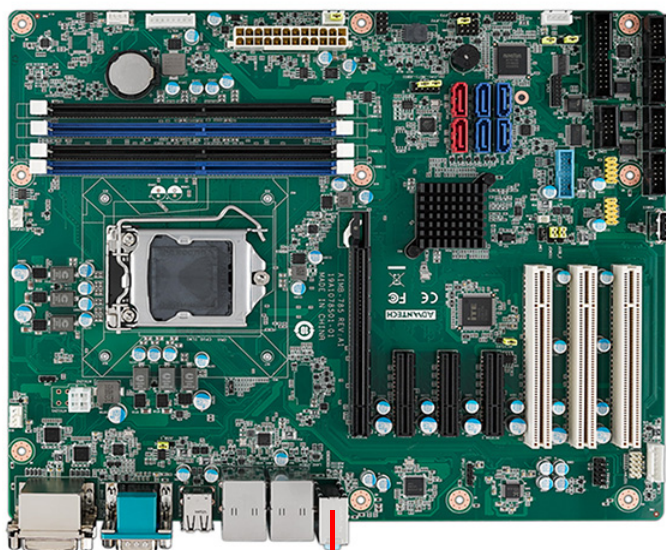

AUDIO1
AUDIO

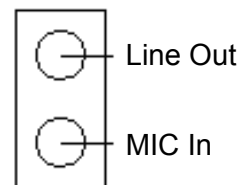

AUDIO1
AUDIO2

Line Out can be connected to external audio devices like speakers or headphones. Mic In can be connected to a microphone.

2.11 8-pin Alarm Board Connector (VOLT1)

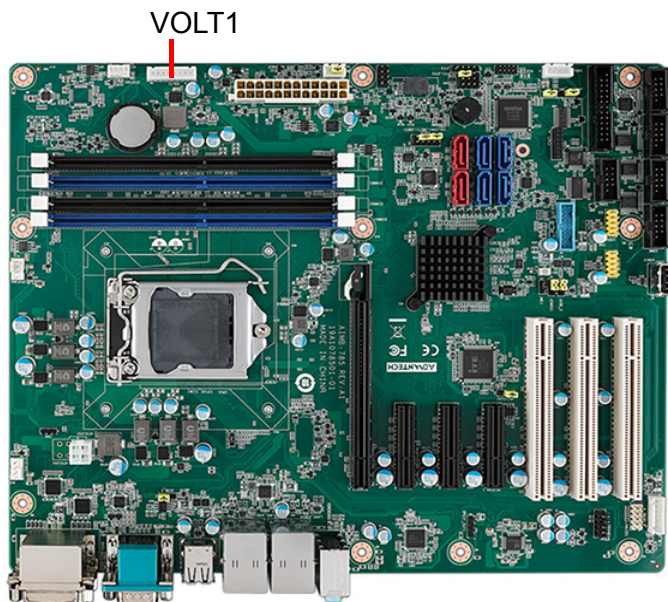

VOLT1

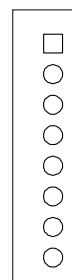

VOLT1 connects to the alarm board on the Advantech chassis. The alarm board gives warnings if a power supply or fan fails, chassis overheats, or the backplane malfunctions.

2.12 Case Open Connector (JCASE1)

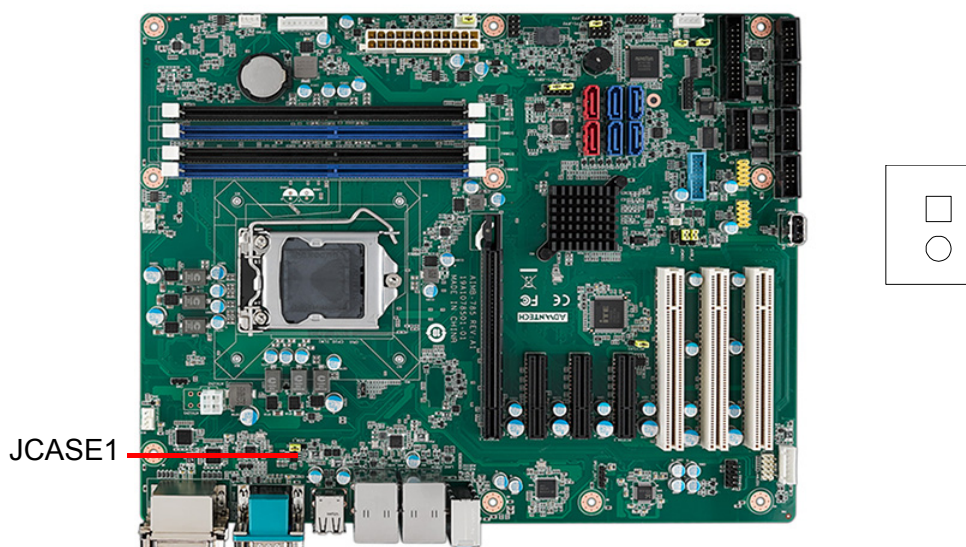

JCASE1 is for chassis with a case open sensor. The buzzer on the motherboard sounds if the case is opened unexpectedly.

2.13 Front Panel LAN Indicator Connector (LANLED1)

Table 2.2: Front Panel LAN Indicator Connector

LAN Mode	Indicator
LAN Link ON	ON
LAN Active	Flash
LAN Link Off	OFF

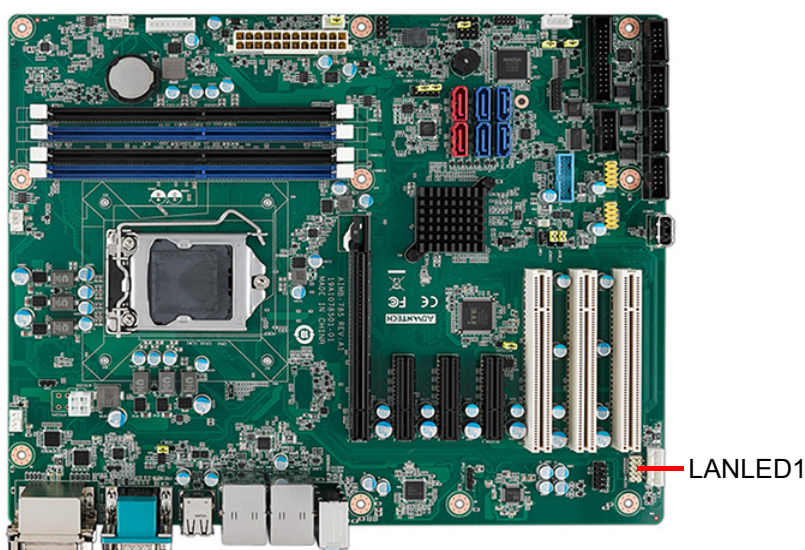

2.14 Serial ATA Interface (SATA0~5)

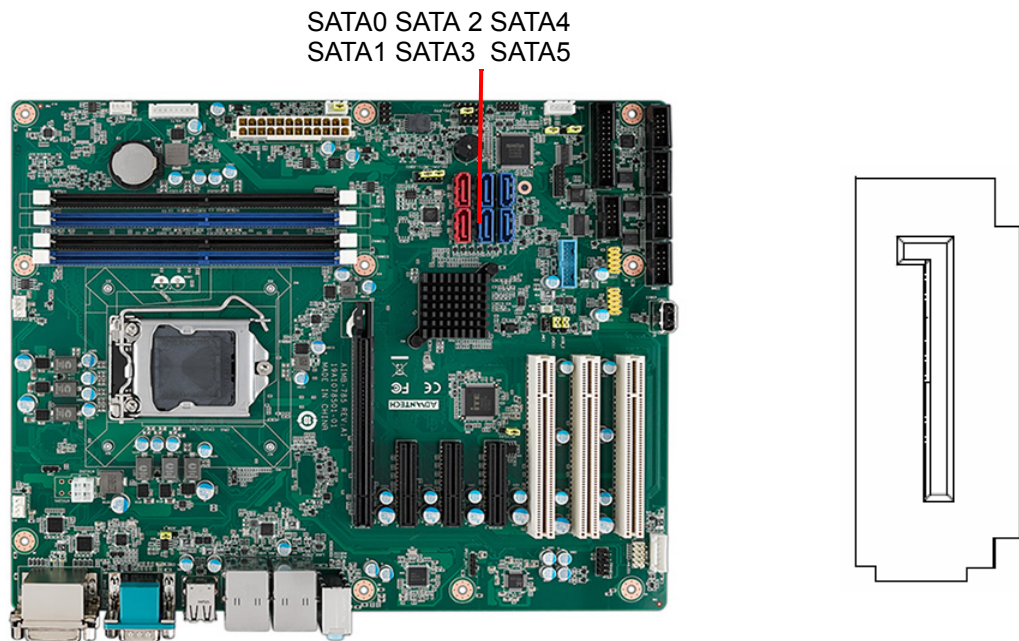

AIMB-785 features six high performance serial ATA III interfaces (up to 600 MB/s) with long, thin, easy-to-run SATA cables.

Note! SATA0 and SATA1 (red ports) are controlled by Marvell chipset supporting PCIe x1 Gen2 with less performance than SATA2~5. These two ports do not support RAID functions.



2.15 PCI Slots (PCI1 ~ PCI3)

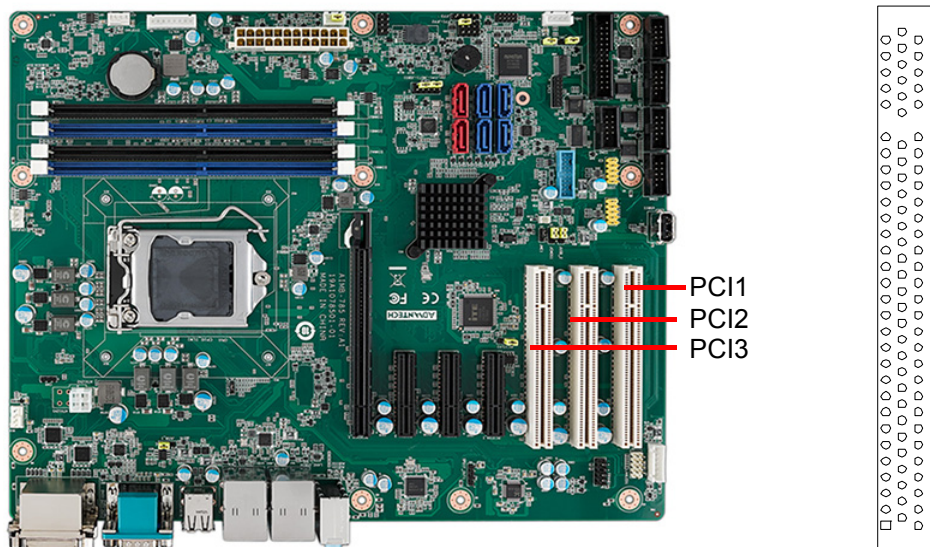

The AIMB-785 provides three 32-bit / 33 MHz PCI slots.

2.16 PCIe x16 Expansion Slot (PCIEX16_1)

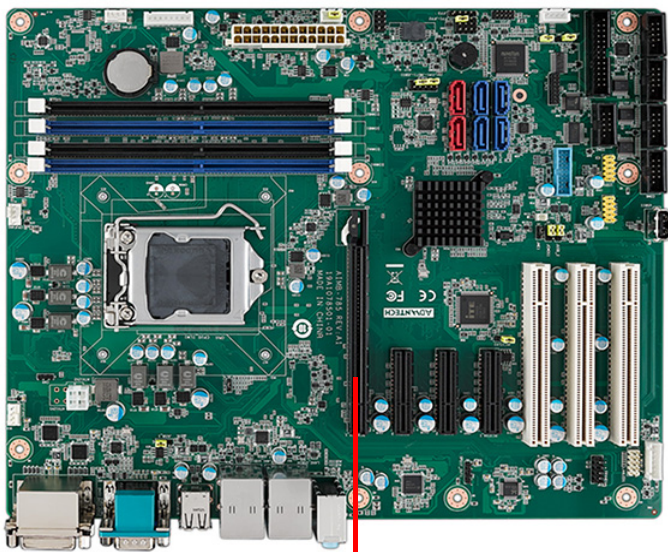

PCIe x16_1

The AIMB-785 provides a PCIe x16 slot for users to install an add-on peripheral card for extension requirements.



2.17 PCIEX4_1 ~ PCIEX4_3

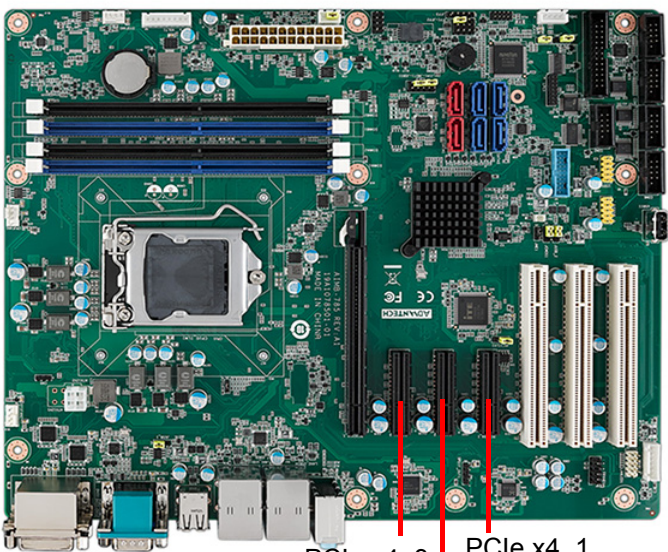

PCIe x4_3
PCIe x4_2
PCIe x4_1



2.18 Auxiliary 4-pin power connector (ATX12V1)

To ensure the enough power is supplied to the motherboard, one auxiliary 4-pin power connector is available on the AIMB-785. ATX1 must be used to provide sufficient 12 V power to ensure the stable operation of the system.

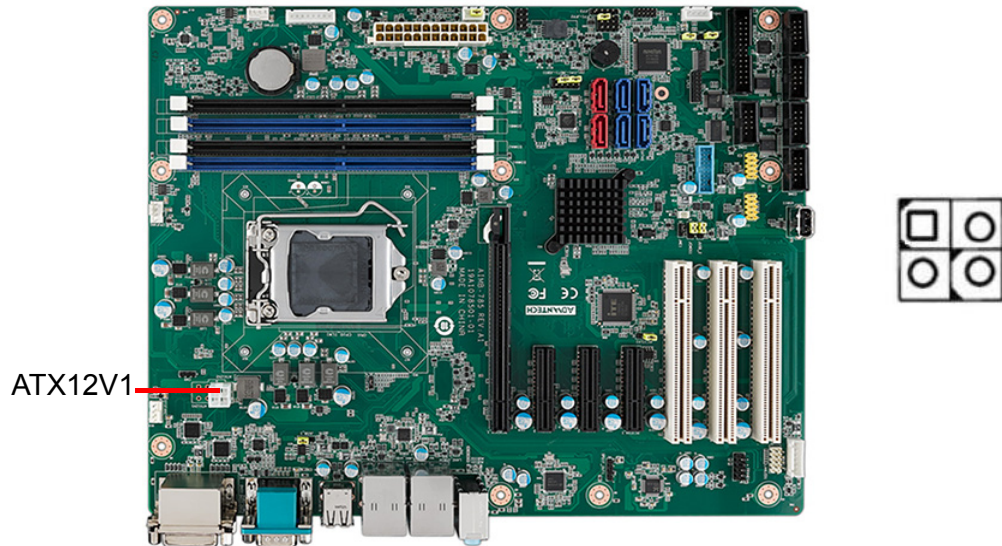

2.19 SPI Flash Connector (SPI_CN1)

The SPI flash card (fixture) via the pin header of SPI_CN1 can flash the BIOS if AIMB-785 BIOS has crashed and can't be powered up (booted up).

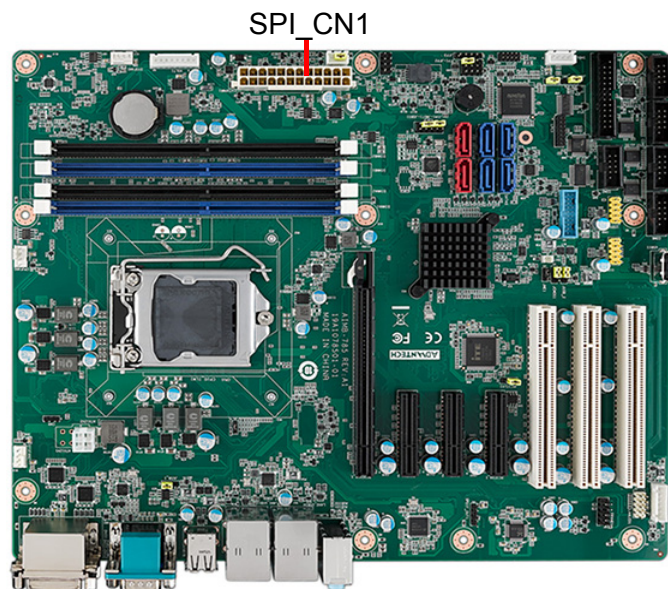

2.20 Low Pin Count Connector (LPC1)

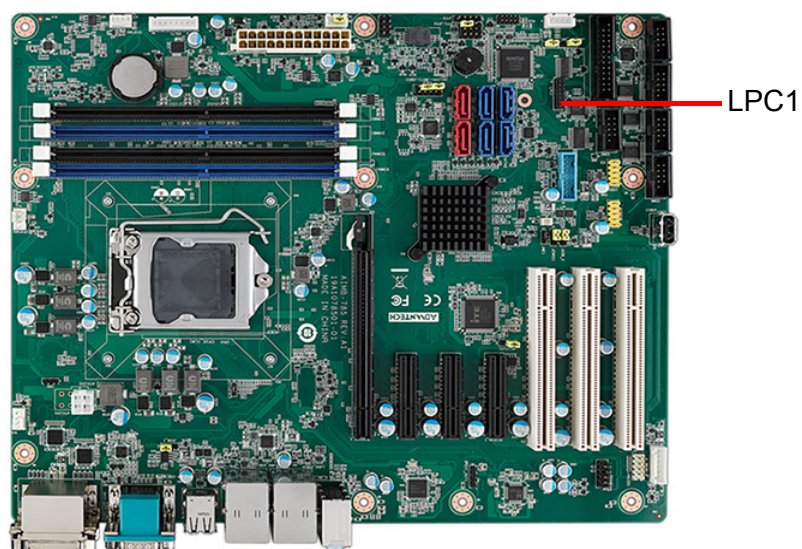

LPC connector on AIMB-785 is reserved for Advantech LPC modules.

Table 2.3: Advantech LPC Module List

P/N	Description
PCA-TPM-00A1E	TPM Module

Chapter 3

BIOS Operation

3.1 Introduction

With the AMI BIOS Setup Utility, you can modify BIOS settings and control the specific features of your computer. The Setup Utility uses a number of menus for making changes and turning the specific features on or off. This chapter describes the basic navigation of the AIMB-785 setup screens.

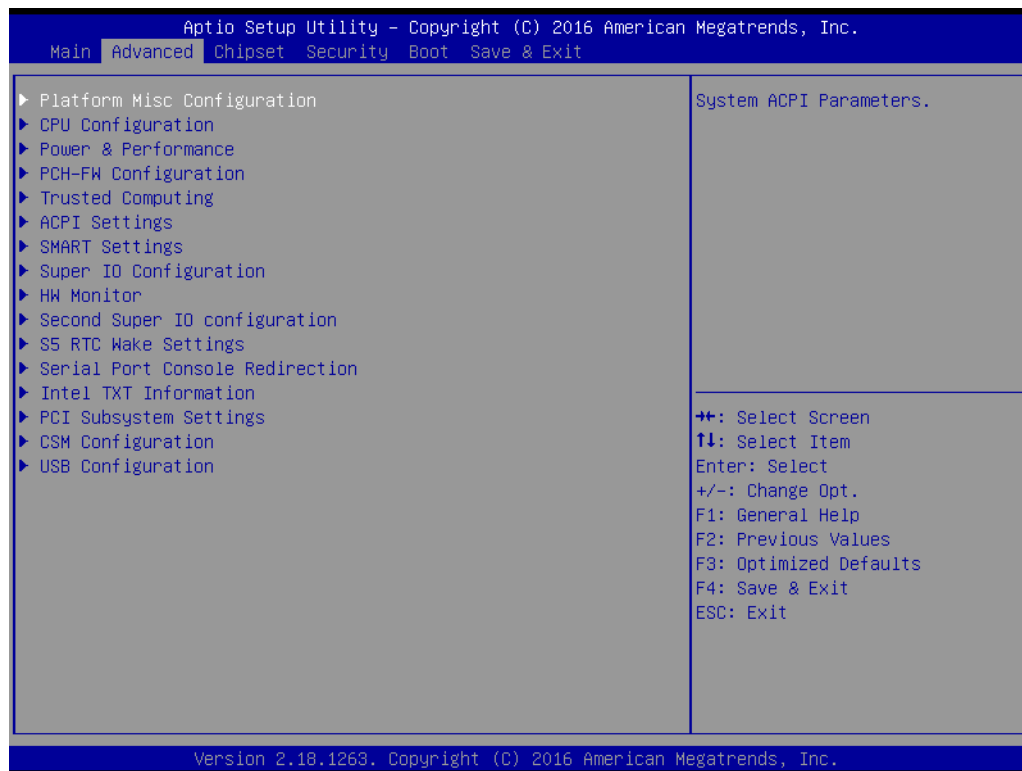

Figure 3.1 Main setup screen

AMI's BIOS ROM has a built-in Setup program that allows users to modify the basic system configuration. This information is stored in NVRAM area so it retains the Setup information when the power is turned off.

3.2 Entering BIOS Setup

Press to enter AMI BIOS Setup Utility, the Main Menu will appear on the screen. Use arrow keys to select among the items and press <Enter> to accept or enter the sub-menu.

When users first enter the BIOS Setup Utility, they enter the Main setup screen. Users can always return to the Main setup screen by selecting the Main tab. There are two Main Setup options described in this section. The Main BIOS Setup screen is shown below.

3.2.1 Main Menu

Press at bootup to enter AMI BIOS Setup Utility, the Main Menu will appear on the screen. Use arrow keys to select among the items and press <Enter> to accept or enter the sub-menu.



Figure 3.2 Main setup screen

The Main BIOS setup screen has two main frames. The left frame displays all the options that can be configured. Grayed-out options cannot be configured; options in blue can be. The right frame displays the key legend.

The key legend above is an area reserved for a text message. When an option is selected in the left frame, it is highlighted in white. Often a text message will accompany it.

■ System time / System date

Use this option to change the system time and date. Highlight System Time or System Date using the <Arrow> keys. Enter new values through the keyboard. Press the <Tab> key or the <Arrow> keys to move between fields. The date must be entered in MM/DD/YY format. The time must be entered in HH:MM:SS format.

3.2.2 Advanced BIOS Features Setup

Select the Advanced tab from the AIMB-785 setup screen to enter the Advanced BIOS setup screen. You can select any of the items in the left frame of the screen, such as CPU configuration, to go to the sub menu for that item. You can display an Advanced BIOS Setup option by highlighting it using the <Arrow> keys. All Advanced BIOS Setup options are described in this section. The Advanced BIOS Setup screens are shown below. The sub menus are described on the following pages.

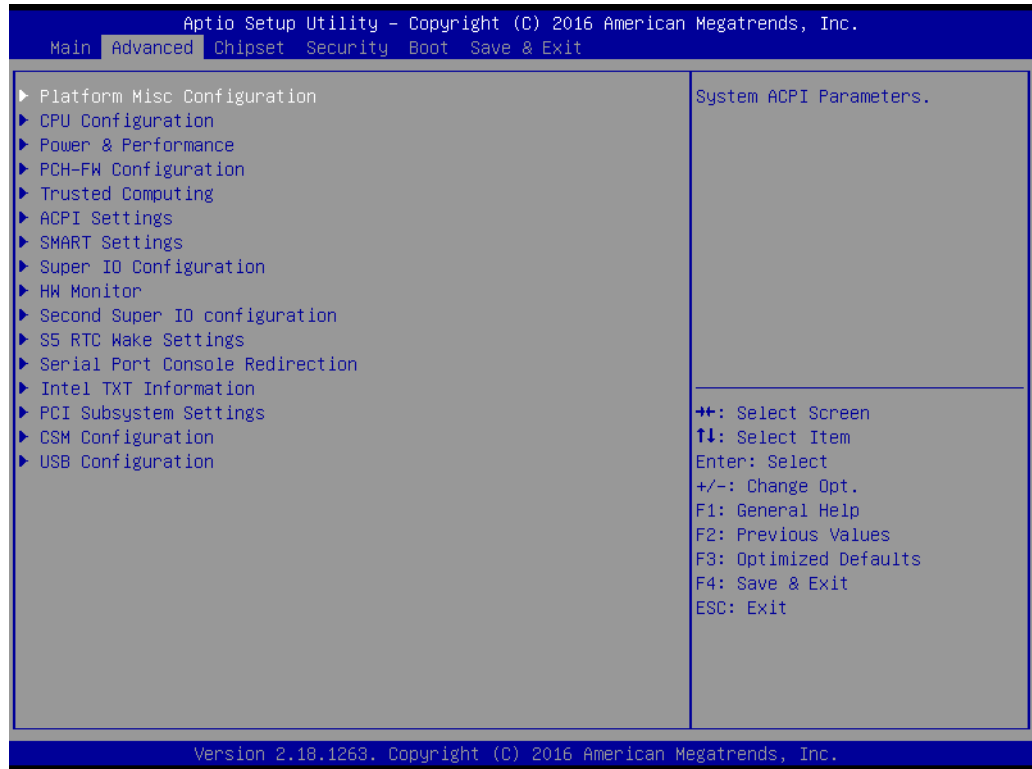

Figure 3.3 Advanced BIOS features setup screen

3.2.2.1 Platform Misc Configuration

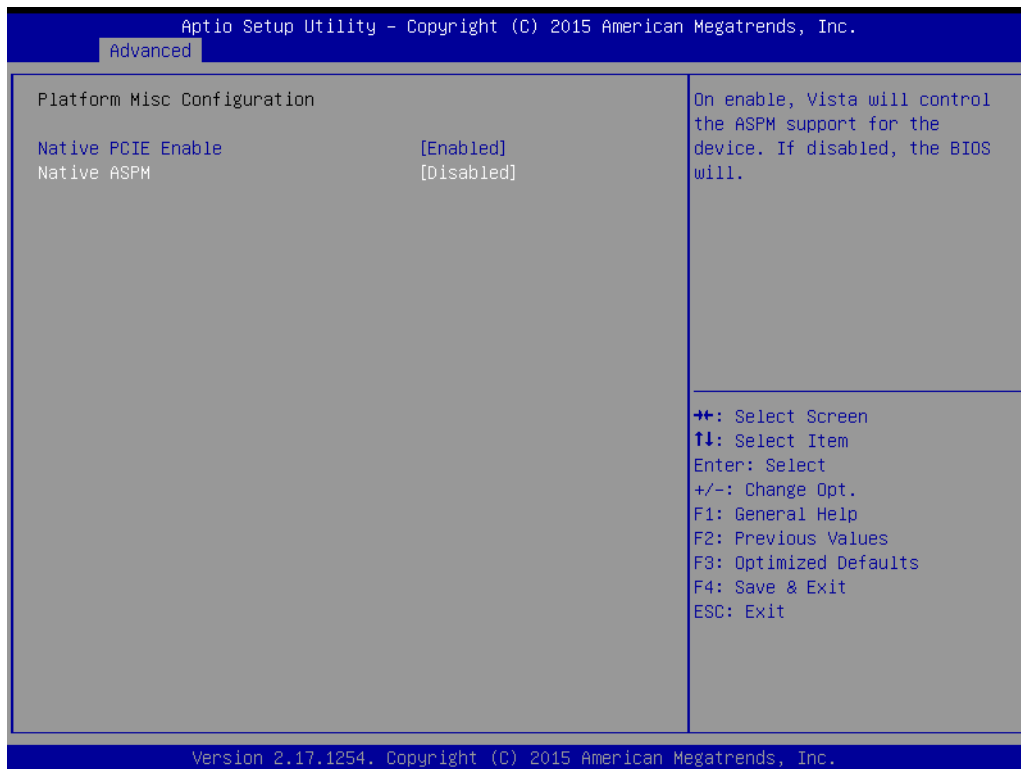

Figure 3.4 Platform Misc Configuration

- **Platform Misc Configuration**
 - **Native PCIE Enable**
PCI Express Native Support Enable/Disable. This is only available in Vista.
 - **Native ASPM**
On enable, Vista will control the ASPM support for the device. If disabled, the BIOS will.

3.2.2.2 CPU Configuration



Figure 3.5 CPU Configuration

- **Hardware Prefetcher**
Hardware Prefetcher is a technique that fetches instructions and/or data from memory into the CPU cache memory well before the CPU needs it to improve the load-to-use latency. You may choose to "Enable or Disable" it.
- **Adjacent Cache Line Prefetch**
The Adjacent Cache-Line Prefetch mechanism, like automatic hardware prefetch, operates without programmer intervention. When it is enabled through the BIOS, two 64-byte cache lines are fetched into a 128-byte sector, regardless of whether the additional cache line has been requested or not. You may choose to "Enable or Disable" it.
- **Intel Virtualization Technology**
This feature is used to "Enable or Disable" the Intel Virtualization Technology (IVT) extension. It allows multiple operating systems to run simultaneously on the same system by creating virtual machines, each running its own x86 operating system.
- **Active Processor Core**
Use this item to select the number of processor cores you want to activate when you are using a dual or quad core processor.
- **AES**
"Enable or Disable" CPA advanced encryption standard instruction.

3.2.2.3 Power & Performance

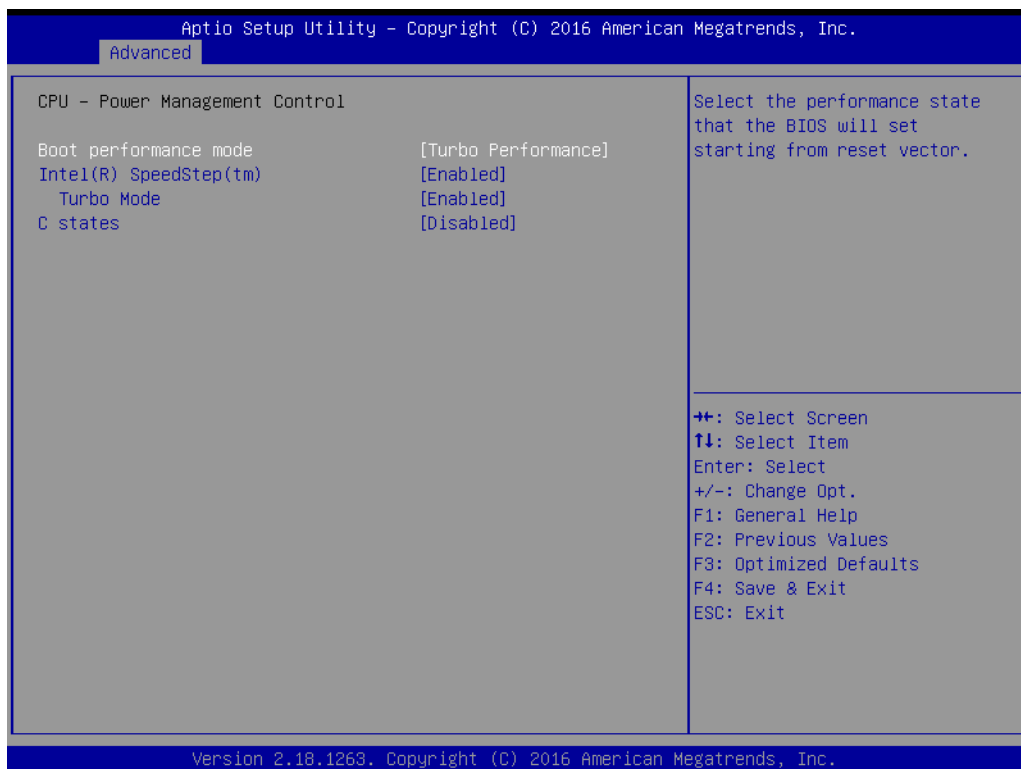
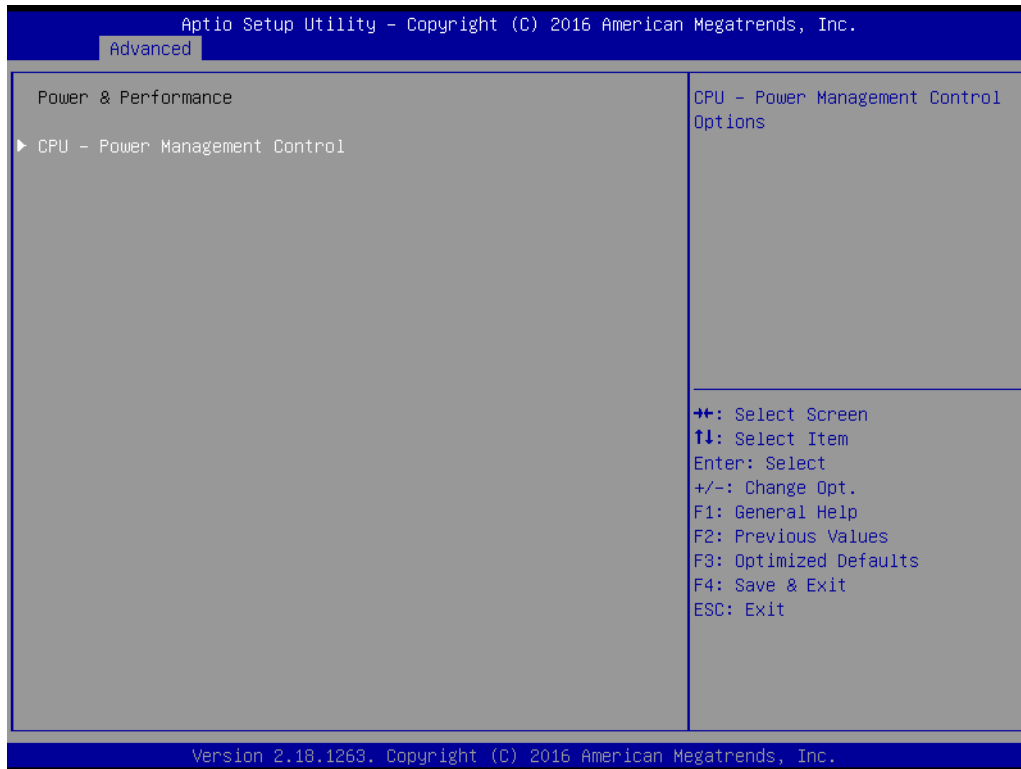

- **Boot Performance**
Select the performance state that the BIOS will set before OS handoff.
- **Intel(R) Speedstep(tm)**
Allows more than two frequency ranges to be supported.

- **Turbo Mode**
Turbo mode.
- **C states**
Intel C states setting for power saving.

3.2.2.4 PCH-FW Configuration



Figure 3.6 PCH-FW Configuration

- **PCH-FW Version**
PCH-FW page shows Intel ME FW information.

■ AMT Configuration



Figure 3.7 AMT Configuration

■ CIRA Configuration

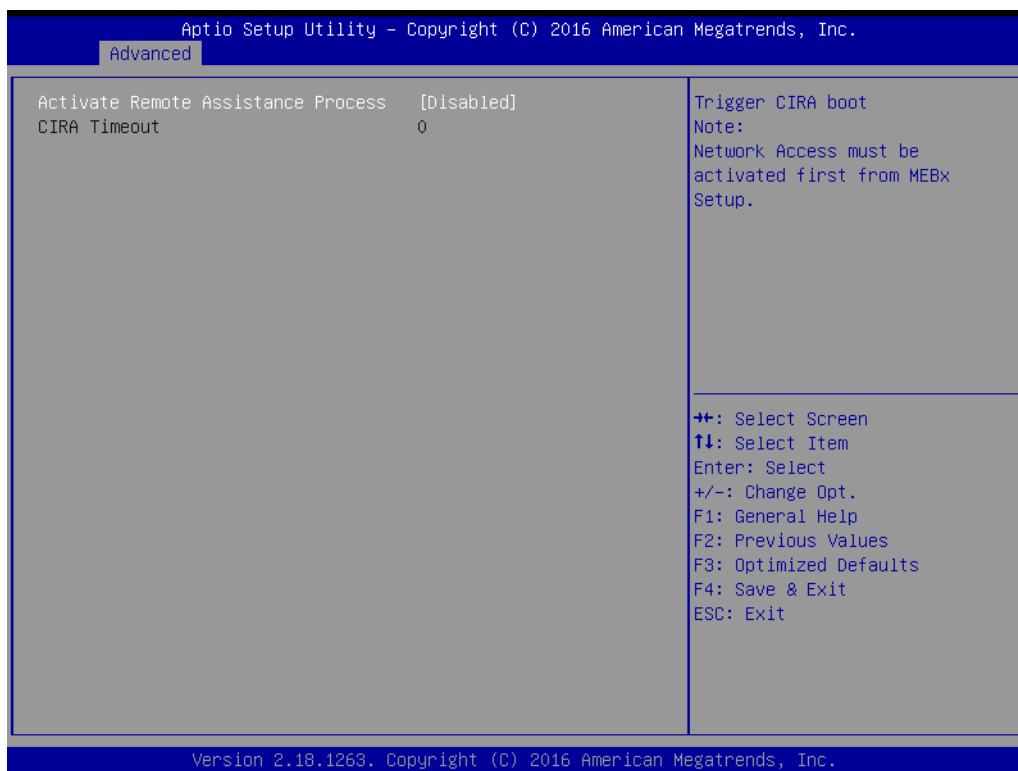

Figure 3.8 CIRA Configuration

- **Activate Remote Assistance Process**
Trigger CIRA boot

■ ASF Configuration



Figure 3.9 ASF Configuration

- **PET Progress**
"Enable or Disable" PET Progress to receive PET event or not
- **WatchDog**
"Enable or Disable" Watchdog Timer

■ Secure Erase Configuration

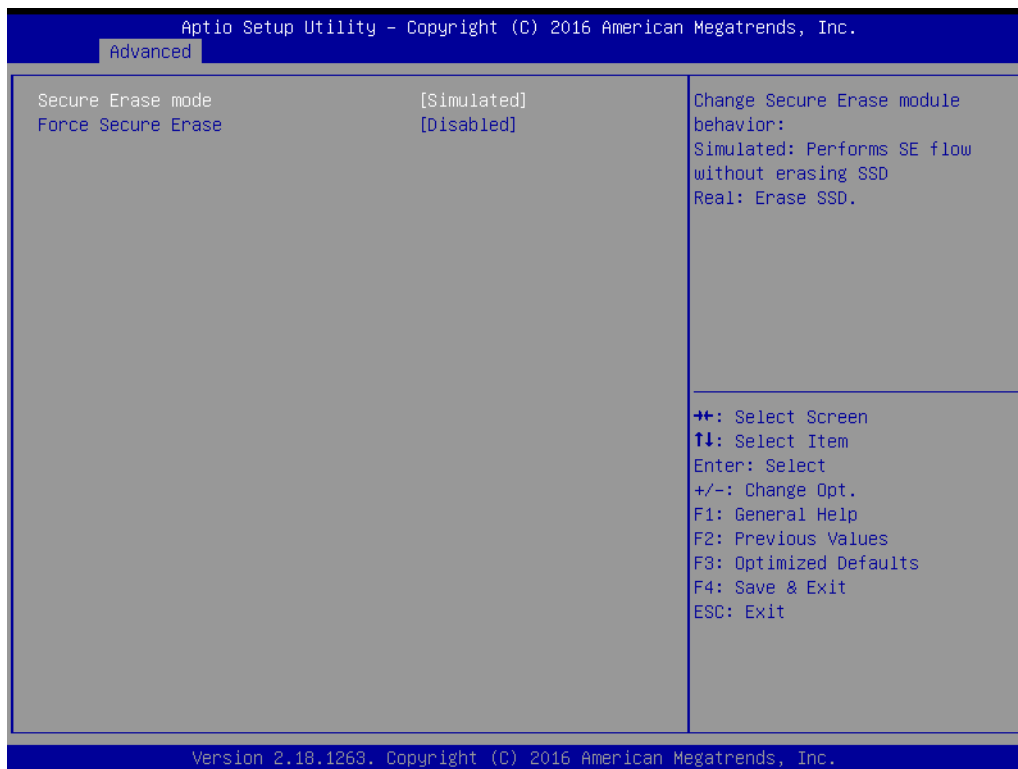

Figure 3.10 Secure Erase Configuration

– Secure Erase mode

Change Secure Erase module behavior as “Simulated or Real”

– Force Secure Erase

“Enable or Disable” to force Secure Erase on next boot

■ OEM Flags Settings

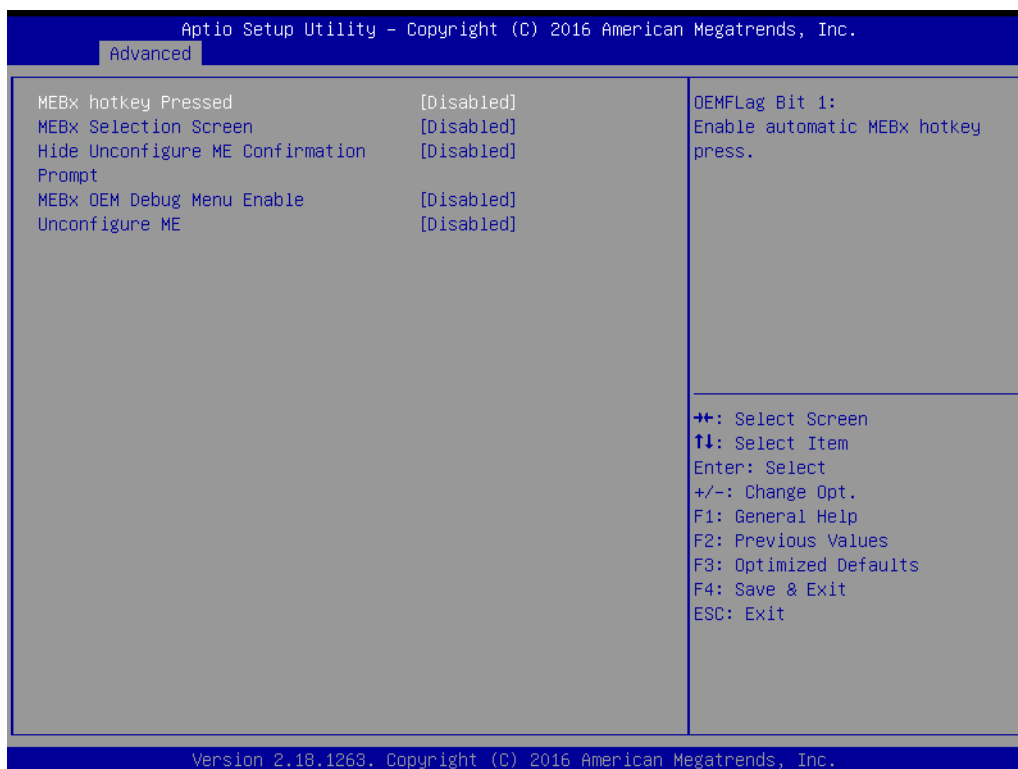

Figure 3.11 OEM Flags Settings

- **BIOS Hotkey Pressed**
"Enable or Disable" BIOS Hotkey press
- **MEBx Selection Screen**
"Enable or Disable" MEBx Selection Screen
- **Hide Un-Configure ME Confirmation Prompt**
Hide Un-Configure ME without password confirmation prompt
- **MEBx OEM Debug Menu Enable**
"Enable or Disable" OEM debug menu in MEBx
- **Unconfigure ME**
Un-Configure ME without password

■ **MEBx Resolution Settings**

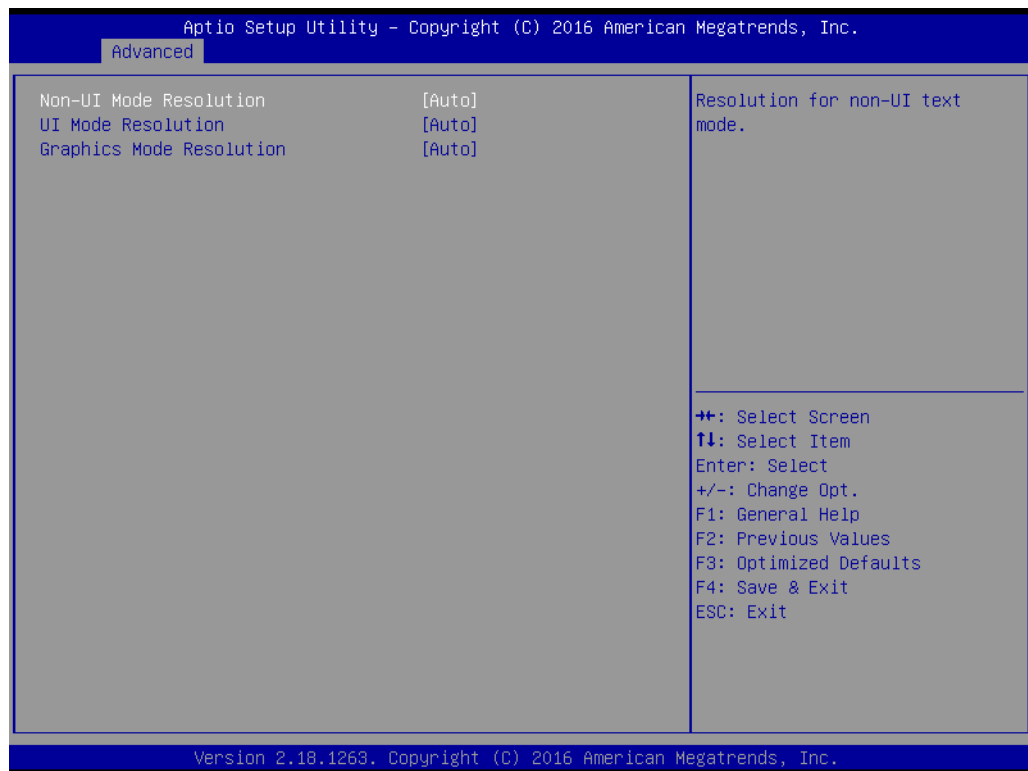

Figure 3.12 MEBx Resolution Settings

- **Non-UI Mode Resolution**
Set resolution for non-UI text mode
- **UI Mode Resolution**
Set resolution for UI text mode
- **Graphics Mode Resolution**
Set resolution for graphics mode

3.2.2.5 Trusted Computing



Figure 3.13 TPM Settings

- **TPM Support**
 “Enable or Disable” TPM Support. You can purchase Advantech LPC TPM module to enable TPM function. P/N: PCA-TPM-00A1E

3.2.2.6 ACPI Settings

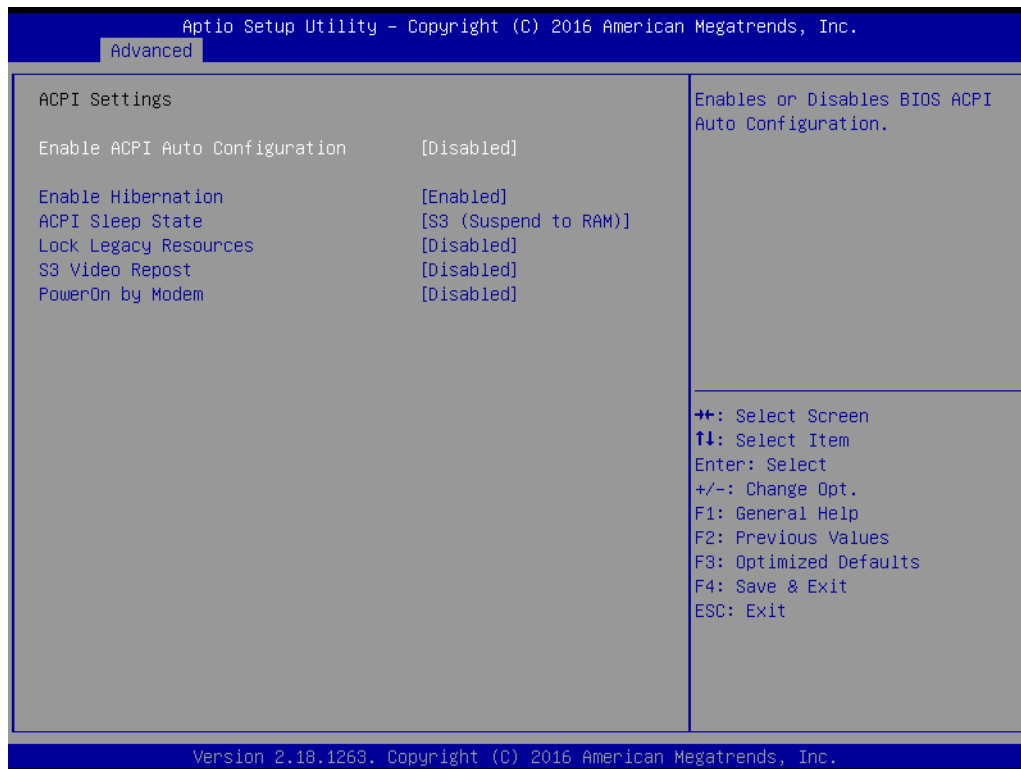

Figure 3.14 ACPI Settings

- **Enable Hibernation**
"Enable or Disable" Hibernation (OS/S4 Sleep State). This option may not be applied in some OS.
- **ACPI Sleep State**
"Auto or S1 only or S3 only" ACPI Sleep State
- **Lock Legacy Resources**
"Enable or Disable" Lock Legacy Resources
- **S3 Video Repost**
"Enable or Disable" S3 Video Repost
- **PowerOn by Modem**
"Enable and Disable" PowerOn by Modem

3.2.2.7 SMART Settings

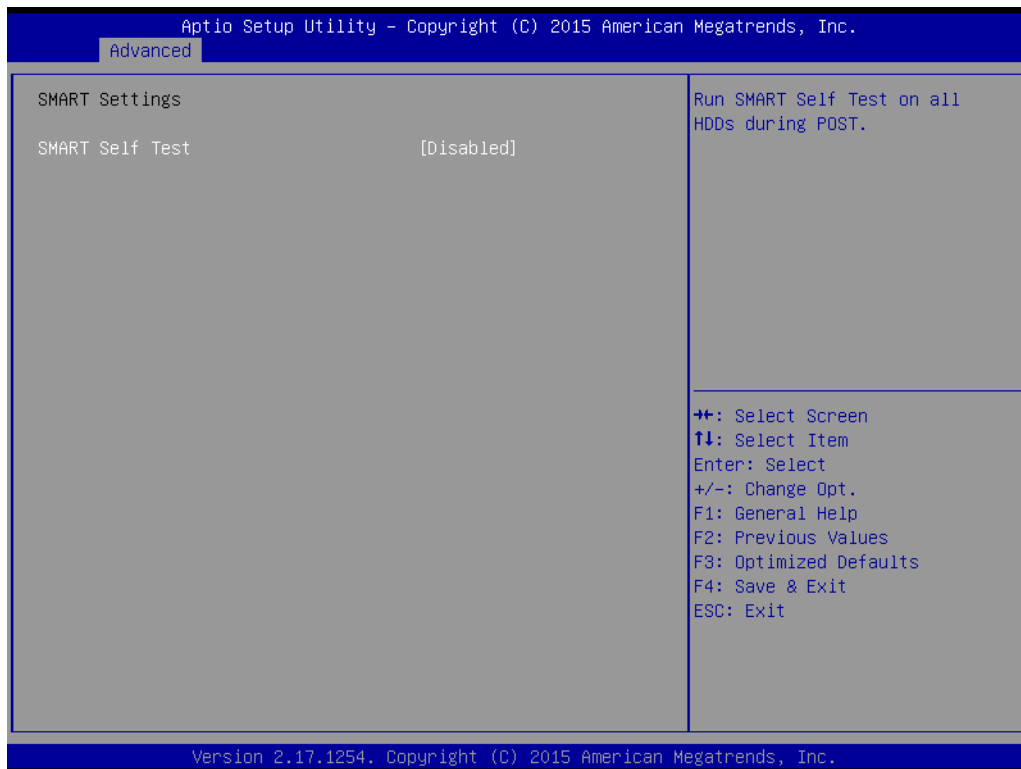

Figure 3.15 SMART Settings

- **SMART Self Test**
"Enable or Disable" SMART Self Test on all HDDs during POST.

3.2.2.8 Super IO Configuration

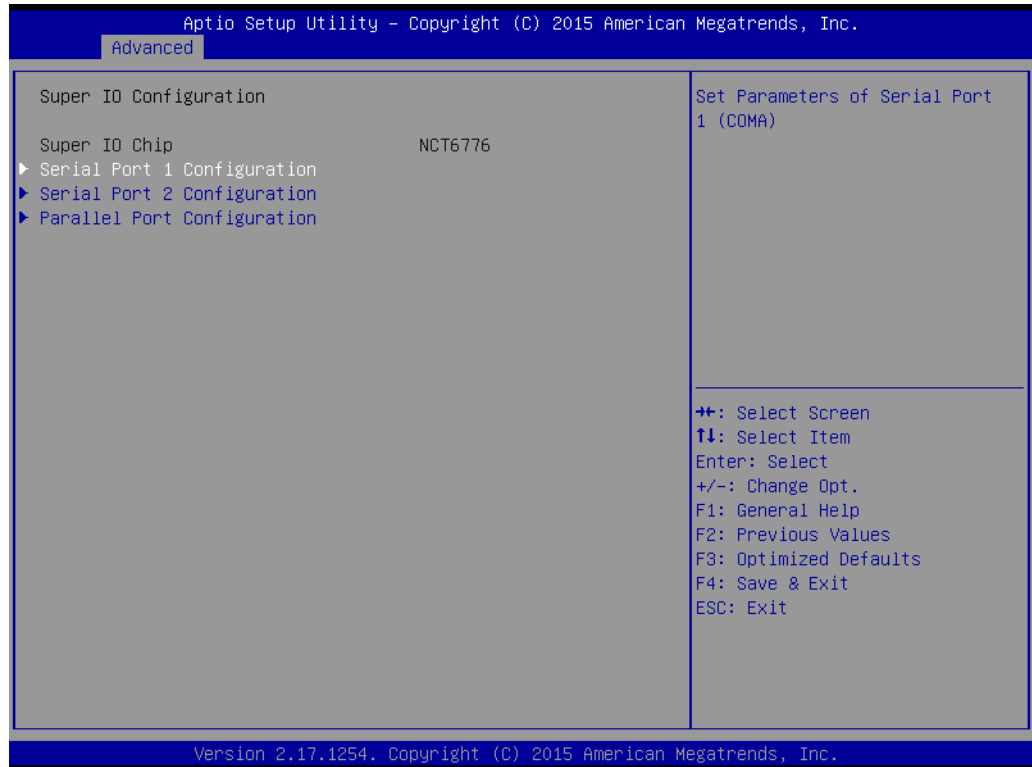

Figure 3.16 Super IO Configuration

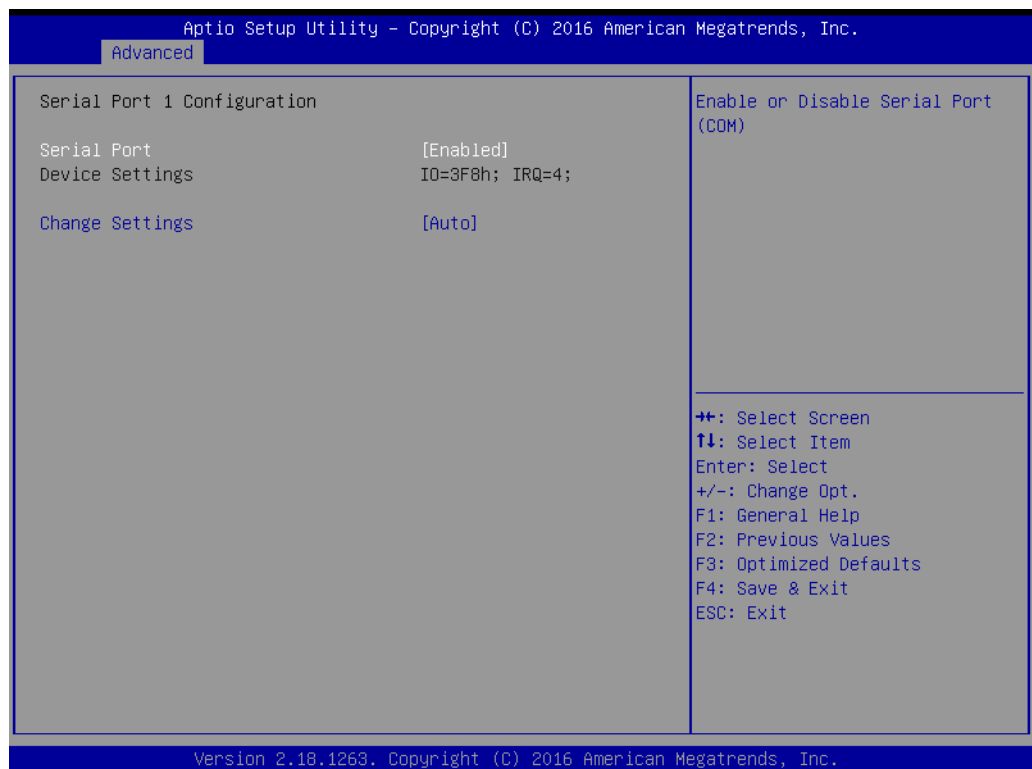

Figure 3.17 Serial Port 1 Configuration

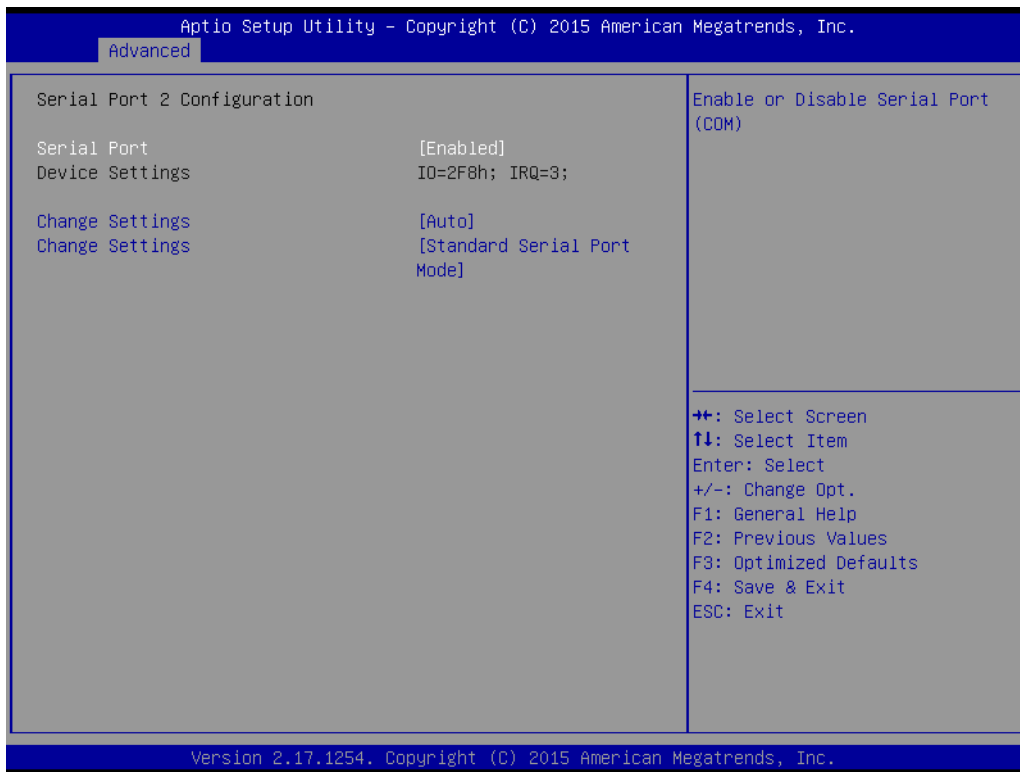

Figure 3.18 Serial Port 2 Configuration

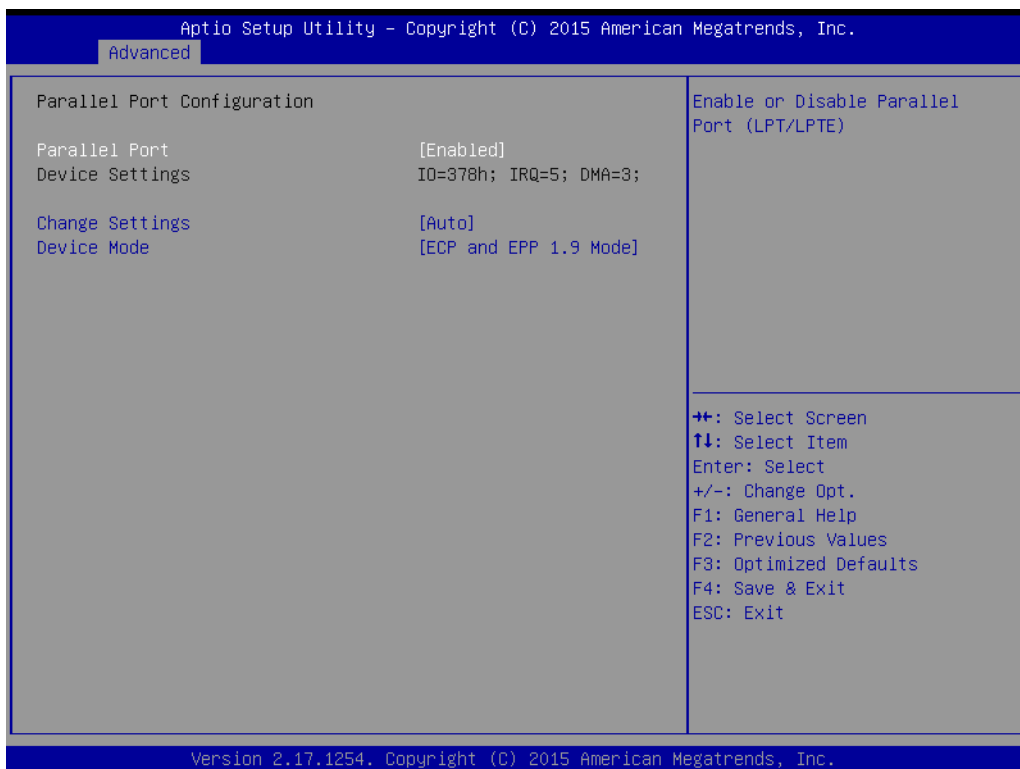

Figure 3.19 Parallel Configuration

- **Serial Port 1 Configuration**
 - **Serial Port**
"Enable or Disable" Serial Port 1.
 - **Change Settings**
To select an optimal setting for serial port 1.
- **Serial Port 2 Configuration**
 - **Serial Port**
"Enable or Disable" Serial Port 2.
 - **Change Settings**
To select an optimal setting for serial port 2.
 - **Device Mode**
Serial port 2 could be selected as "Standard serial port mode" or "IrDA 1.0 (HP SIR) mode".
- **Parallel Port**
To "Enable or Disable" Parallel Port.
 - **Change Settings**
To select an optimal setting for parallel port.
 - **Device Mode**
Parallel port could be selected as "ECP and EPP 1.9 Mode" and other settings.

3.2.2.9 H/W Monitor

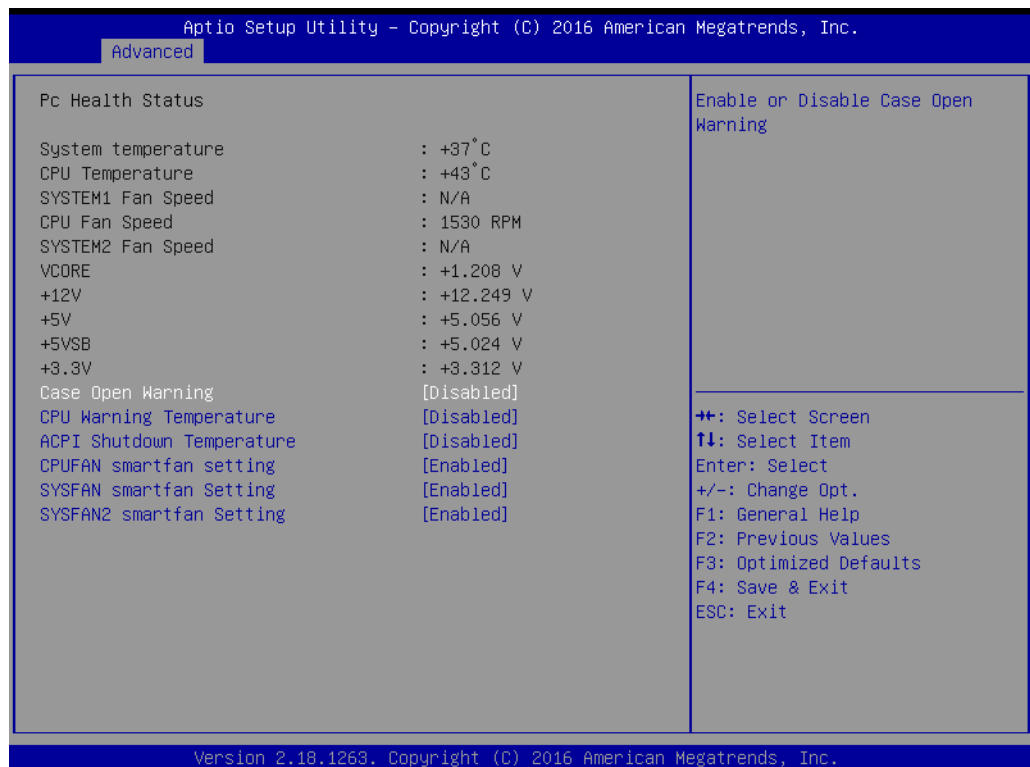

Figure 3.20 PC Health Status

- **Case Open Warning**
To "Enable or Disable" the Chassis Intrusion monitoring function. When it is enabled and the case is opened, the speaker beeps.
- **CPU Warning Temperature**

Use this item to set the CPU warning temperature. When the system reaches the warning temperature, the speaker will beep.

- **ACPI Shutdown Temperature**

Use this item to set the ACPI shutdown temperature. When the system reaches the shutdown temperature, it will be automatically shut down by ACPI OS to protect the system from overheat damage.

- **CPUFAN Mode Setting**

"Enable or Disable" CPUFAN Mode to SMART FAN setting.

- **SYSFAN Mode Setting**

"Enable or Disable" SYSFAN Mode to SMART FAN setting.

- **SYSFAN2 Mode Setting**

Enable or Disable SYSFAN Mode to SMART FAN setting.

3.2.2.10 Second Super IO Configuration

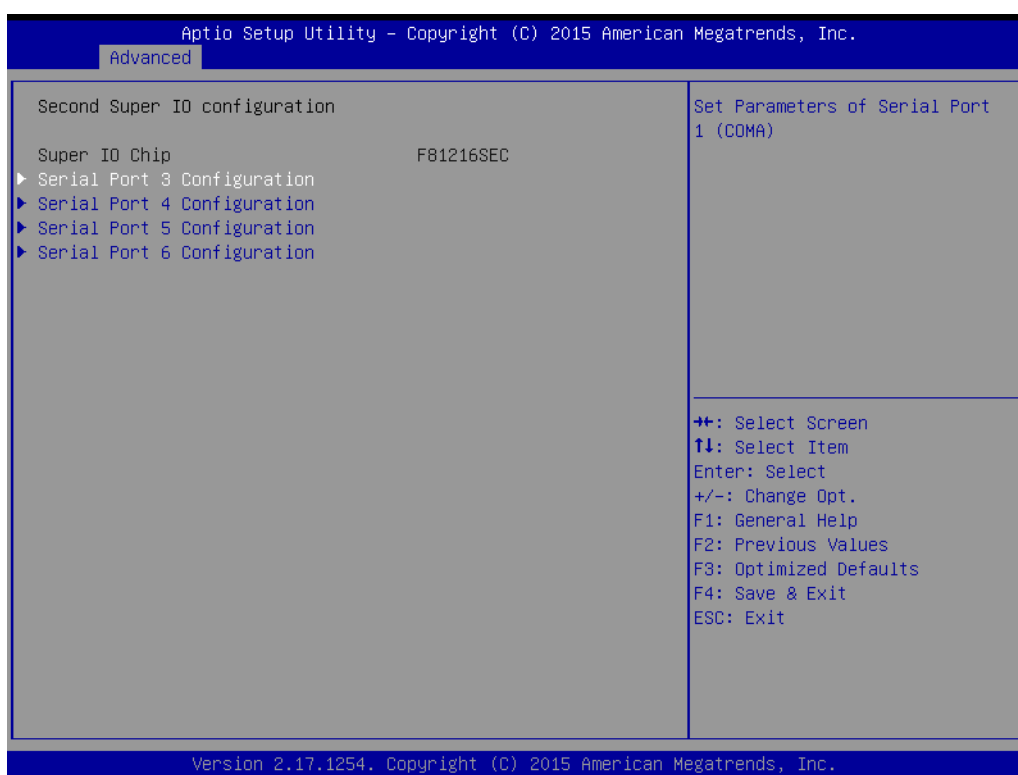

Figure 3.21 Super IO Configuration

AIMB-785 supports 2nd super IO for COM 3~6, this page of BIOS menu is to set respective serial port configuration.

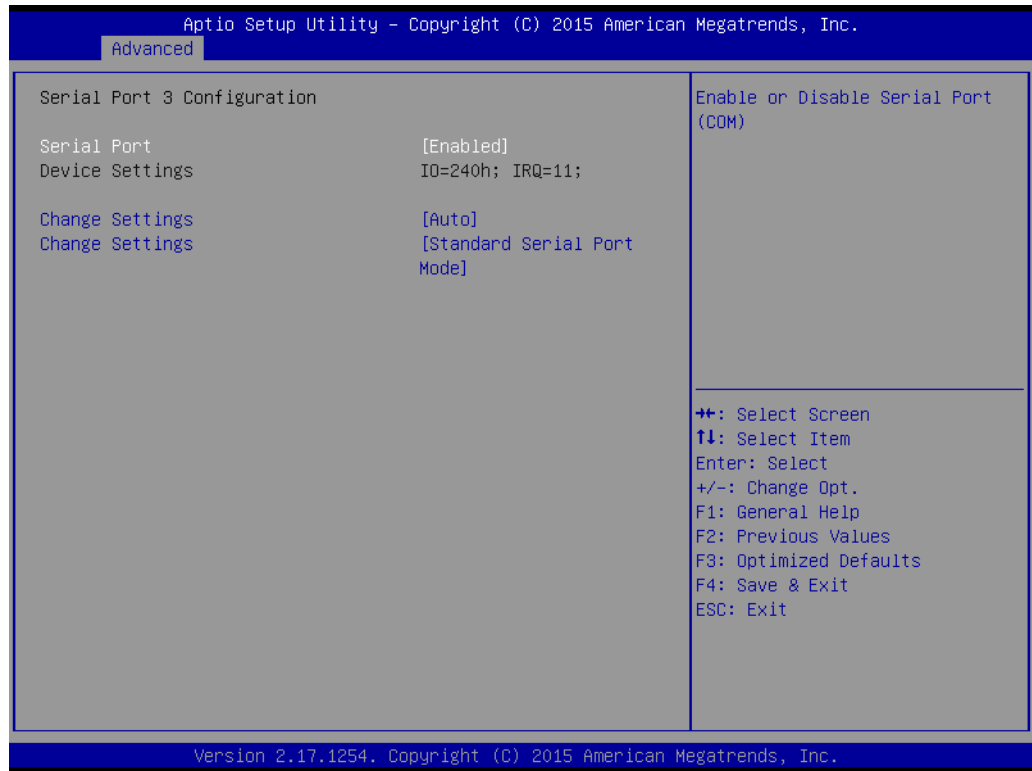

Figure 3.22 Serial Port 3 Configuration

- **Serial Port 3 Configuration**
 - **Serial Port**
To "Enable or Disable" Serial Port 3.
 - **Change Settings**
To select an optimal setting for serial port 3.
 - **Device Mode**
Can be selected to Serial Port Function Mode (RS-232), RS-485 Half Duplex, or RS-422 Full Duplex.

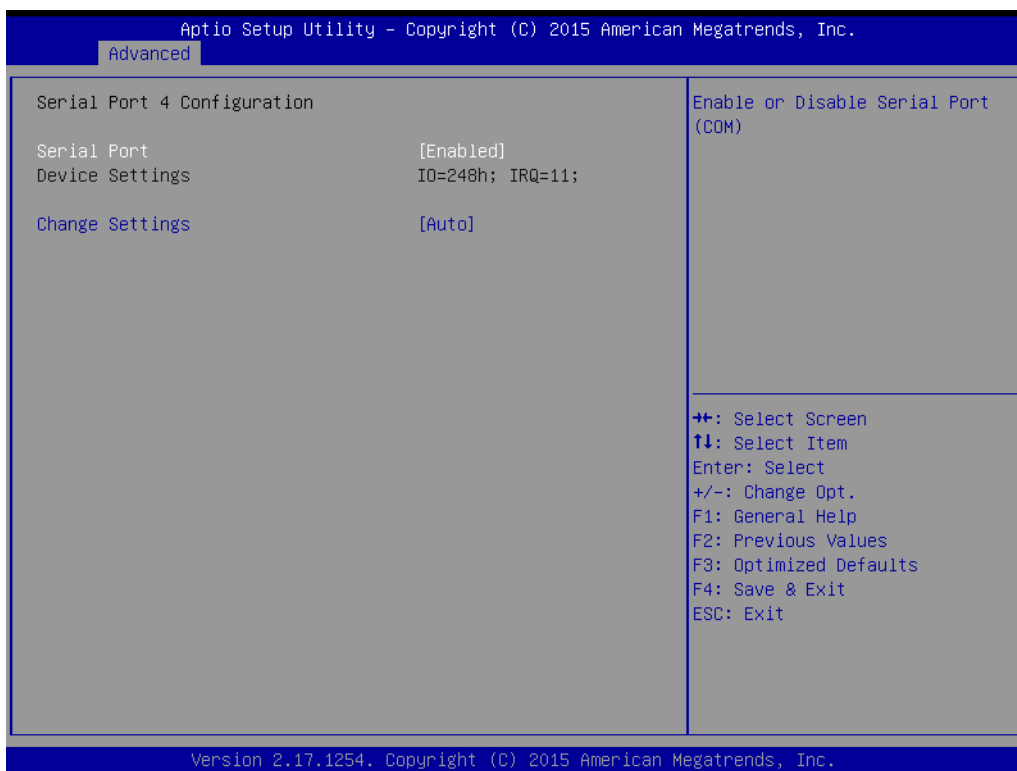

Figure 3.23 Serial Port 4 Configuration



Figure 3.24 Serial Port 5 Configuration

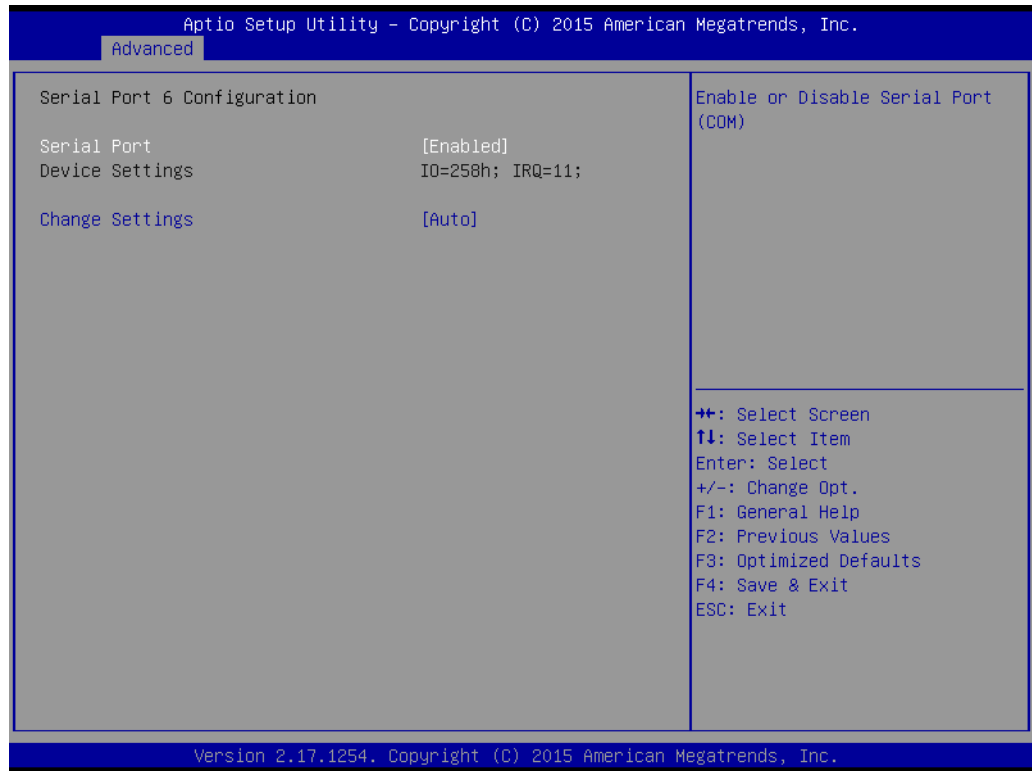

Figure 3.25 Serial Port 6 Configuration

- **Serial Port 4 configuration**
 - **Serial Port**
To "Enable or Disable" Serial Port 4.
 - **Change Settings**
To select an optimal setting for serial port 4.
- **Serial Port 5 configuration**
 - **Serial Port**
To "Enable or Disable" Serial Port 5.
 - **Change Settings**
To select an optimal setting for serial port 5.
- **Serial Port 6 configuration**
 - **Serial Port**
To "Enable or Disable" Serial Port 6.
 - **Change Settings**
To select an optimal setting for serial port 6.

3.2.2.11 S5 RTC Wake Settings

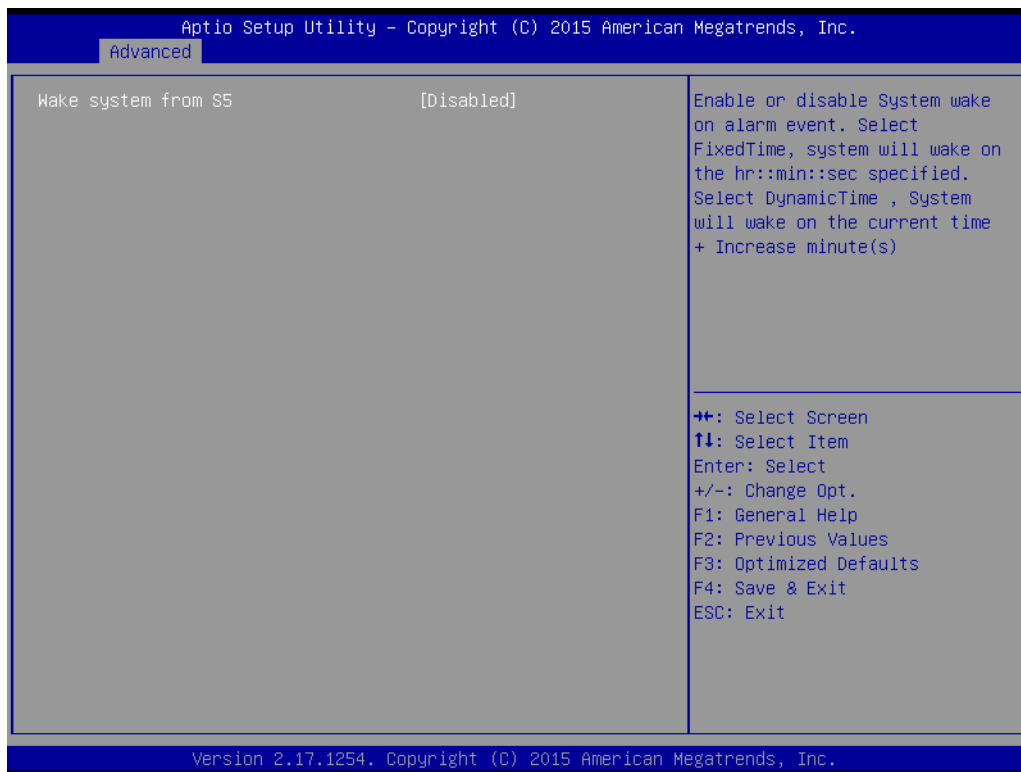

Figure 3.26 S5 RTC Wake Settings

- **Wake system with Fixed Time**
To "Enable or Disable" System wake on alarm event. The system will wake on the hr:min:sec as specified.

3.2.2.12 Serial Port Console Redirection

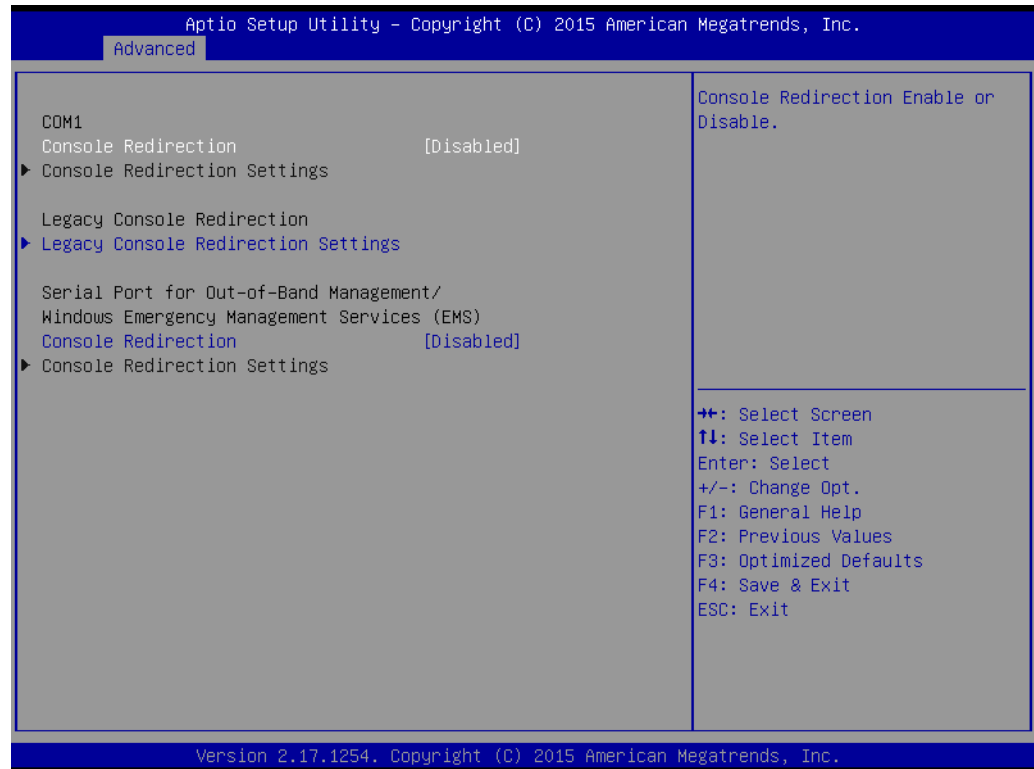

Figure 3.27 Serial Port Console Redirection

- **COM1**
 - **Console Redirection Settings**
 - Console Redirection Enable or Disable
- **Legacy Console Redirection**
 - **Legacy Console Redirection Settings**
 - Legacy Console Redirection Settings
- **Serial Port for Out-of-Band Management/ Windows Emergency Management services (EMS)**
 - **Console Redirection**
 - Console Redirection Enable or Disable

3.2.2.13 Intel TXT Information

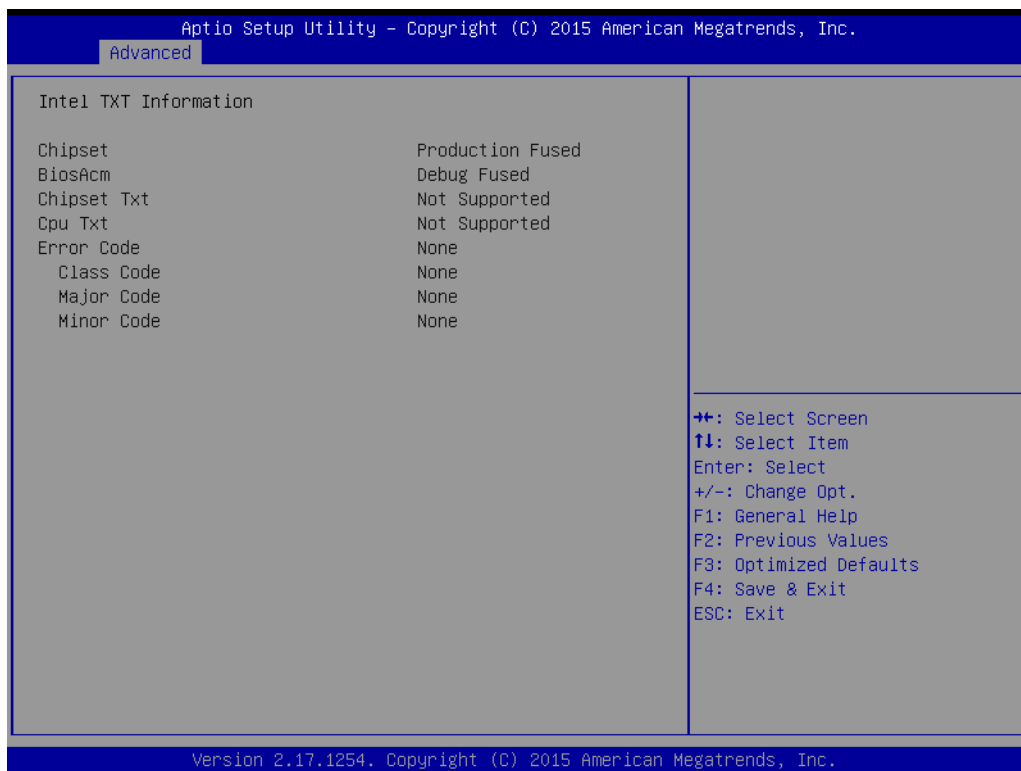

Figure 3.28 Intel TXT Information

3.2.2.14 PCI Subsystem Settings

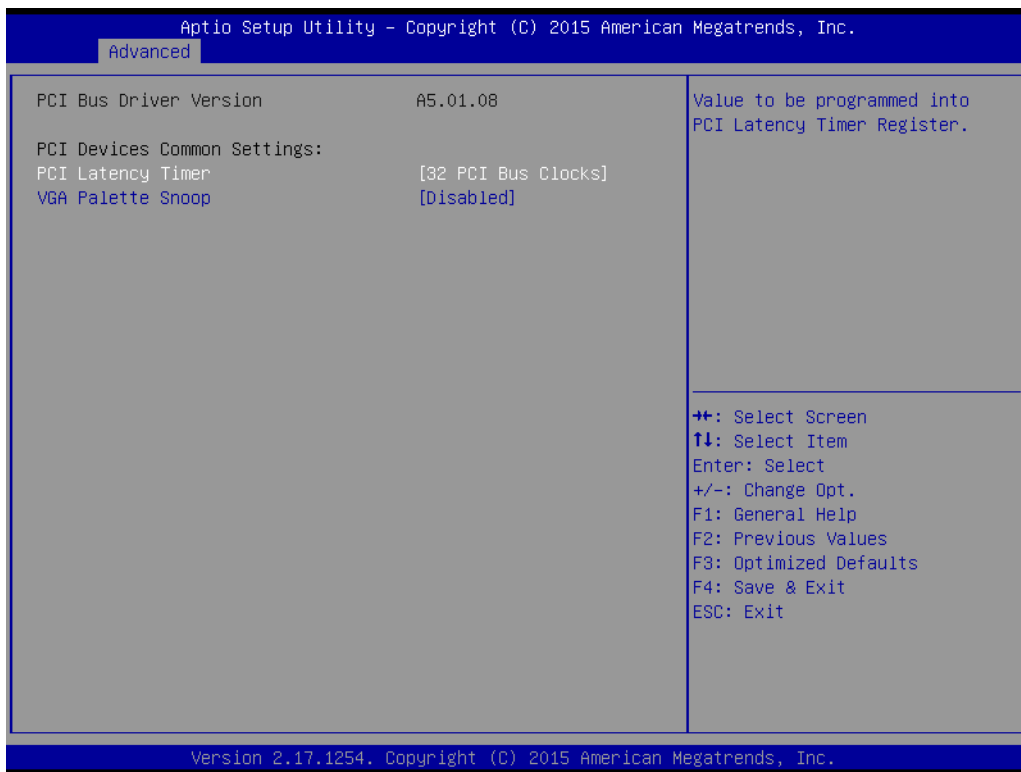

Figure 3.29 PCI Subsystem Settings

- PCI Common Settings
 - PCI Latency Timer

Value to be programmed into PCI Latency Timer Register.

VGA Palette Snoop

"Enable or Disable" VGA palette registers snooping.

3.2.2.15 CSM Configuration

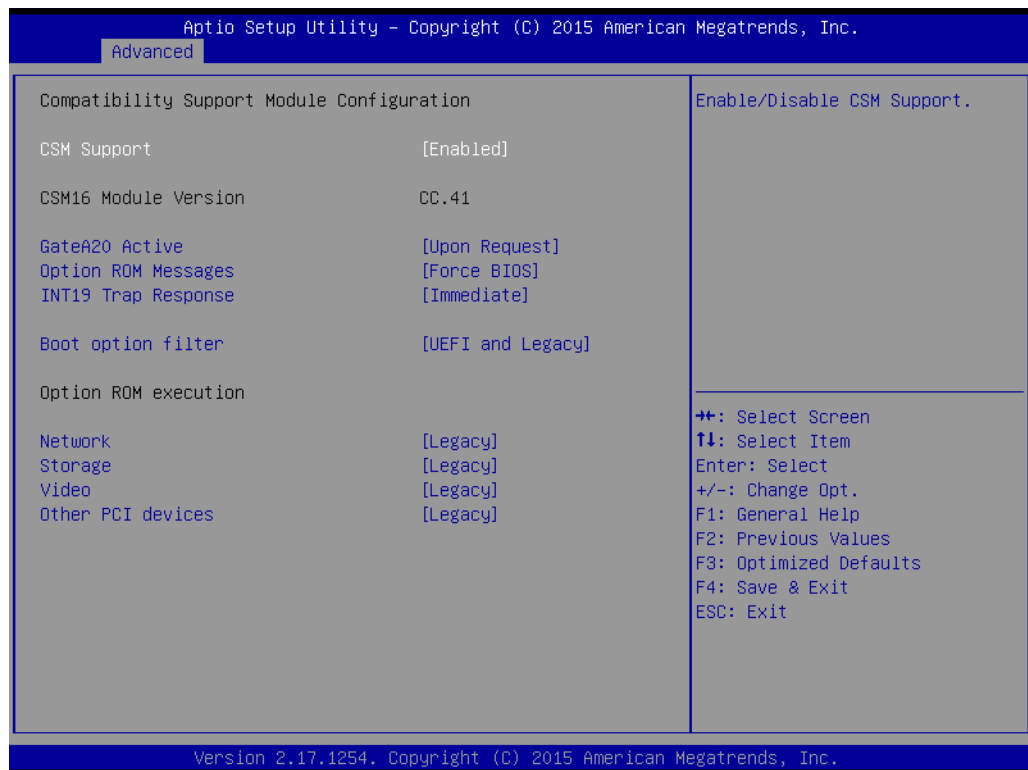

Figure 3.30 CSM Configuration

- **Compatibility Support Module Configuration**
 - **CSM Support**
Enable/Disable CSM Support.
- **CSM16 Module Version**
 - **GateA20 Active**
Upon Request - GA20 can be disabled using BIOS services. Always - do not allow disabling GA20; this option is useful when any RT code is executed above 1MB.
 - **Option ROM Message**
Set display mode for Option ROM.
 - **INT19 Trap Response**
BIOS reaction on INT19 trapping by Option ROM: Immediate - execute the trap right away; Postponed - execute the trap during legacy boot.
 - **Boot option filter**
This option controls Legacy/UEFI ROMs Priority.
- **Option ROM execution**
 - **Network**
Controls the execution of UEFI and Legacy PXE OpROM.
 - **Storage**
Controls the execution of UEFI and Legacy Storage OpROM.
 - **Video**

Controls the execution of UEFI and Legacy Video OpROM.

– **Other PCI devices**

Determines OpROM execution policy for devices other than Network, Storage, or Video.

3.2.2.16 USB Configuration

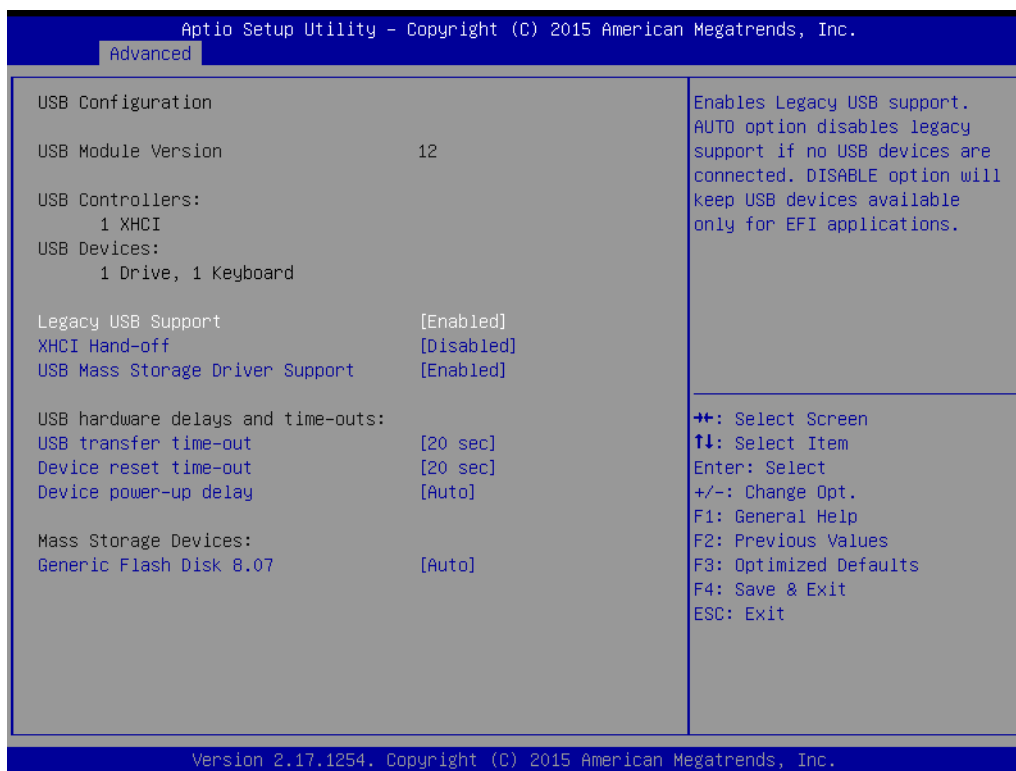

Figure 3.31 USB Configuration

- **Legacy USB Support**
This is for supporting USB device under legacy OS such as DOS. When choosing "AUTO", the system will automatically detect if any USB device is plugged into the computer and enable USB legacy mode when a USB device is plugged and disable USB legacy mode when no USB device is plugged.
- **XHCI Hand-off**
This is a workaround for OS without XHCI hand-off support. The XHCI ownership change should be claimed by XHCI driver.
- **USB Mass Storage Driver Support**
Enable or Disable USB Mass Storage driver support.
- **USB transfer time-out**
Allows you to select the USB transfer time-out value. [1,5,10,20sec]
- **Device reset time-out**
Allows you to select the USB device reset time-out value. [10,20,30,40sec]
- **Device power-up delay**
Maximum time the device will take before it properly reports itself to the Host Controller. "Auto" uses default value: for a Root port it is 100 ms, for a Hub port the delay is take from Hub descriptor.
- **Generic Flash disk 8.07**
Mass storage device emulation type. "Auto" enumerates device according to their media format. Optical drives are emulated as 'CDROM', drives with no media will be emulated according to a drive type.

3.2.3 Chipset



Figure 3.32 Chipset

This page provides information of the chipset on AIMB-785.

3.2.3.1 System Agent (SA) Configuration

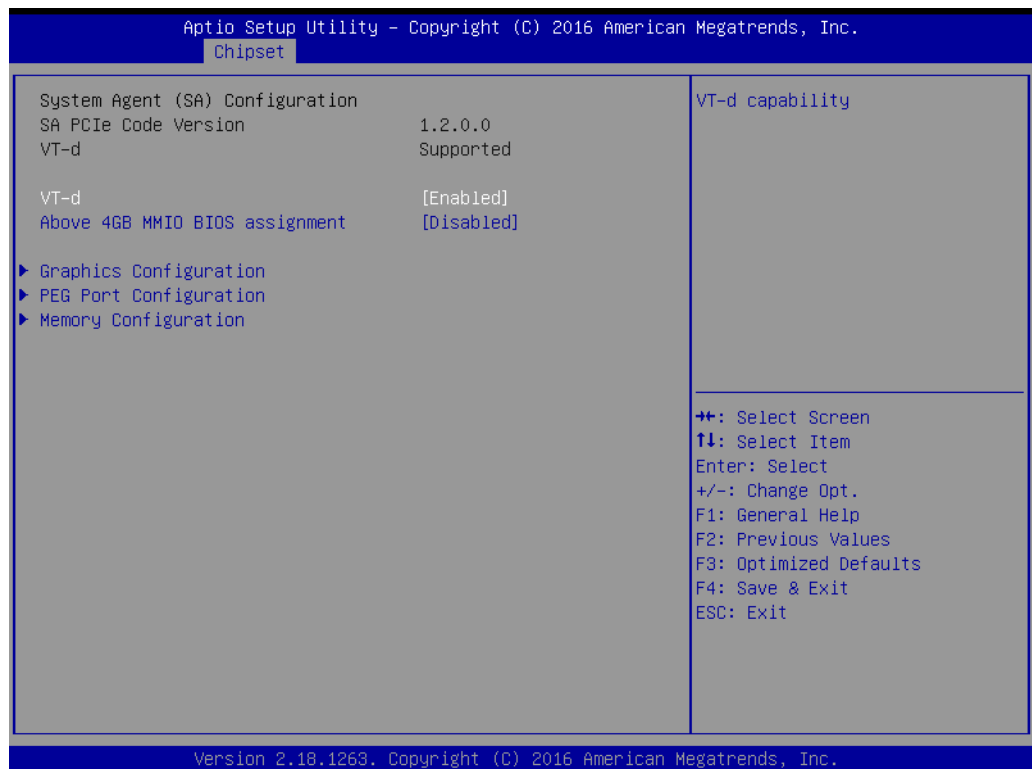

Figure 3.33 System Agent (SA) Configuration

- **VT-d**
"Enable or Disable" VT-d function.

3.2.3.2 Graphics Configuration

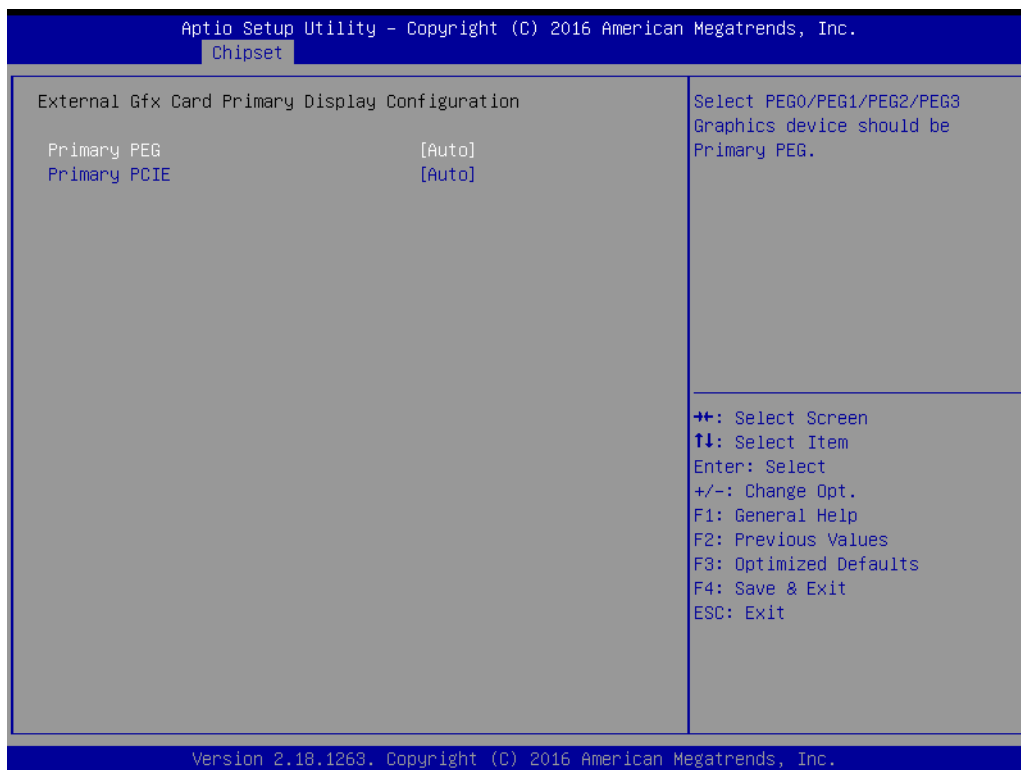
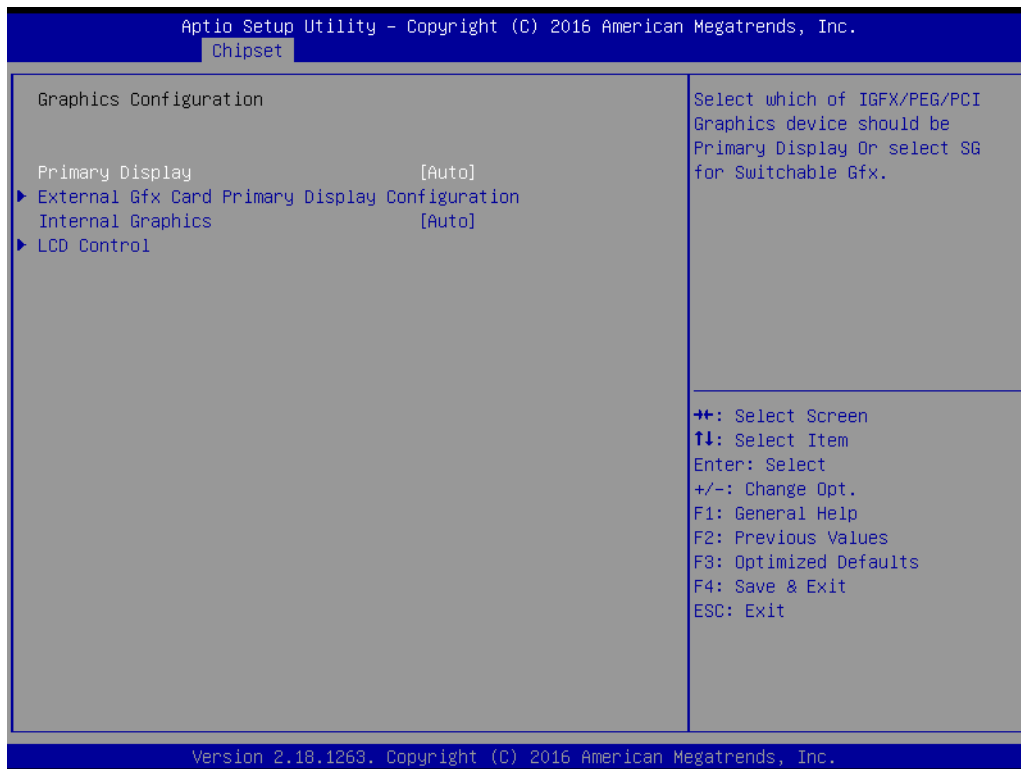

Figure 3.34 Graphics Configuration

- **Primary Display**
"Auto or IGFX or PEG or PCI or SG" optimal to Primary Display

- **Primary PEG**
Select PEG0/PEG1/PEG2/PEG3 graphics device should be Primary PEG.
- **Primary PCIE**
Select Auto/ PCIE1/ PCIE2/ PCIE3/ PCIE4/ PCIE5/ PCIE6/ PCIE7 of D28: F0/ F1/ F2/ F3/ F4/ F5/ F6/ F7, PCIE8/PCIE9/PCIE10/PCIE11/PCIE12/PCIE13/ PCIE14/PCIE15 of D29: F0/ F1/ F2/ F3/ F4/ F5/ F6/ F7/, PCIE16/ PCIE17/ PCIE18/ PCIE19 of D27: F0/ F1/ F2/ F3, Graphics device should be primary PCIE.
- **Internal Graphics**
"Auto or Disable or Enable" Internal Graphics.
- **LCD Control**

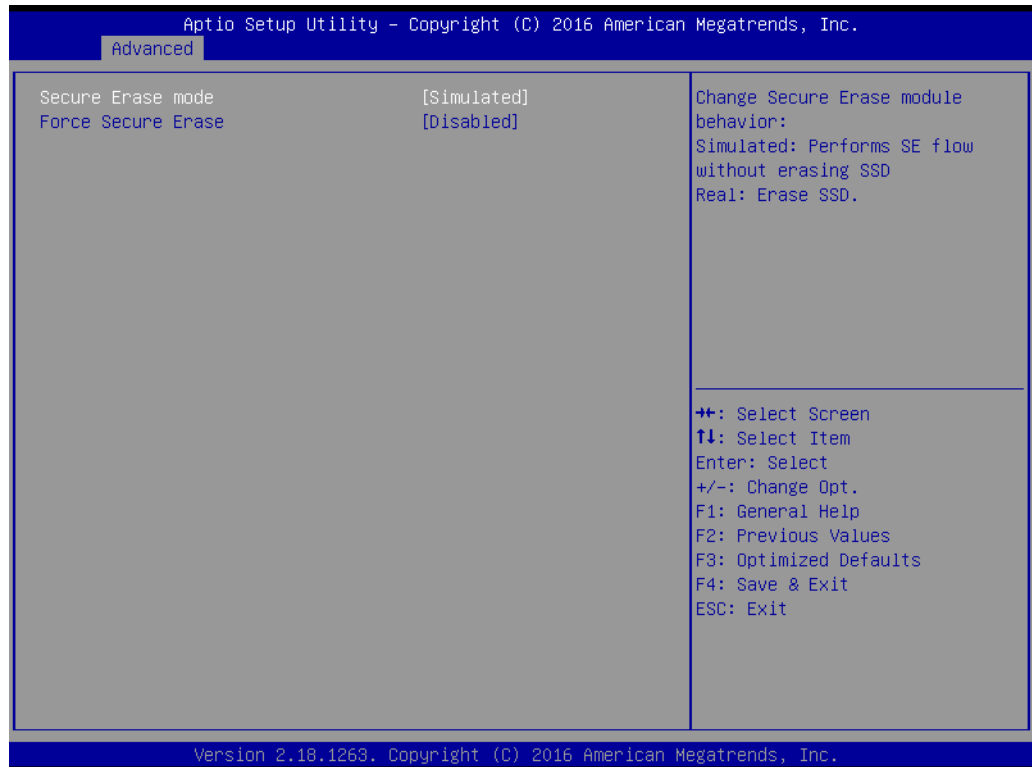

Figure 3.35 LCD Control

- **LCD Control**
Select Primary IGFX Boot Display (VBIOS Default, VGA, DVI1, DVI2).

3.2.3.3 PEG Port Configuration

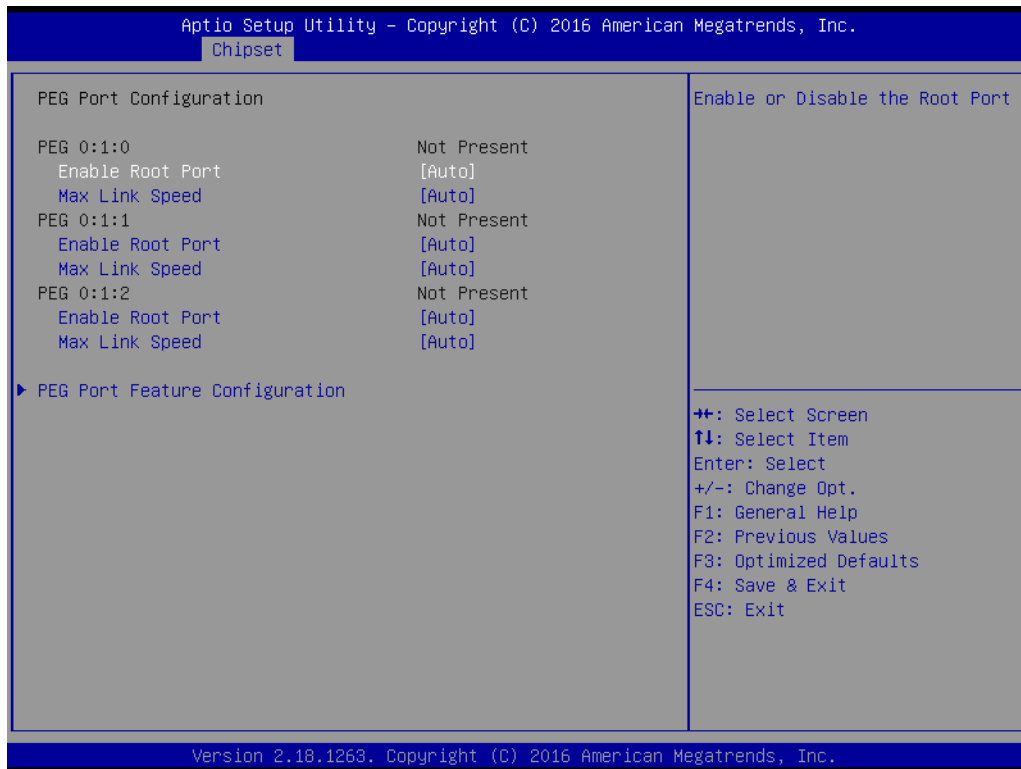

Figure 3.36 PEG Port Configuration

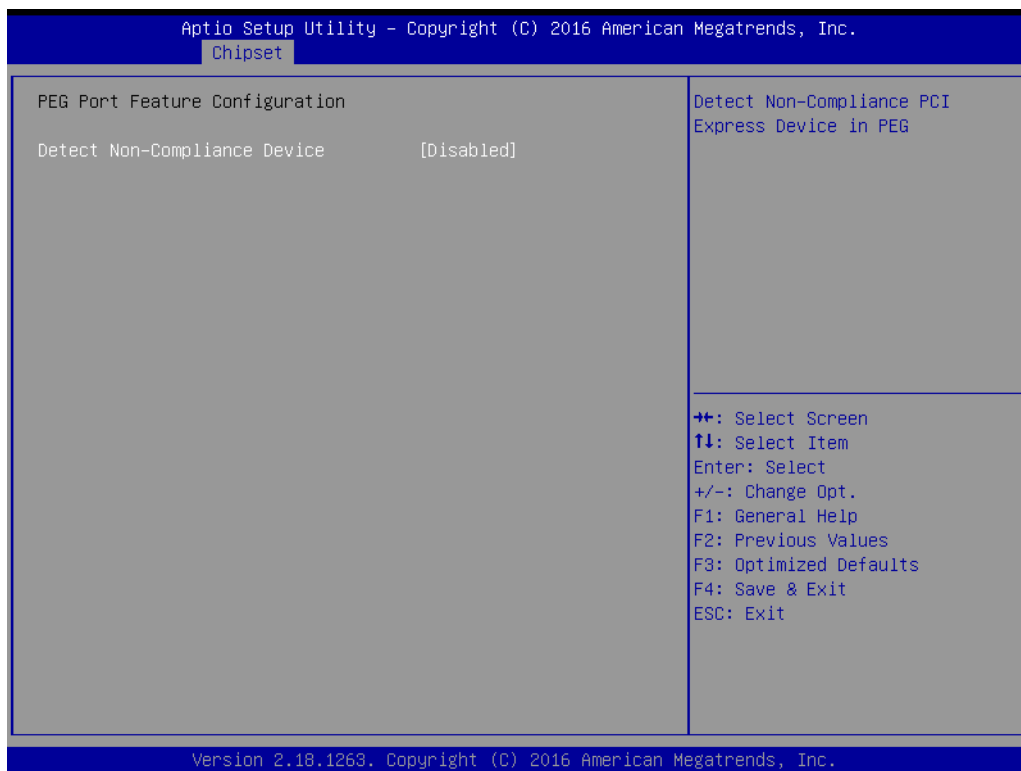

Figure 3.37 PEG Port Feature Configuration

- **Enable Root Port**
Enable or disable the root port
- **Max Link speed**
Configure PEG 0:1:0 max speed

- **Detect Non-compliance device**
Detect Non-Compliance PCI express Device in PEG

3.2.3.4 Memory Configuration

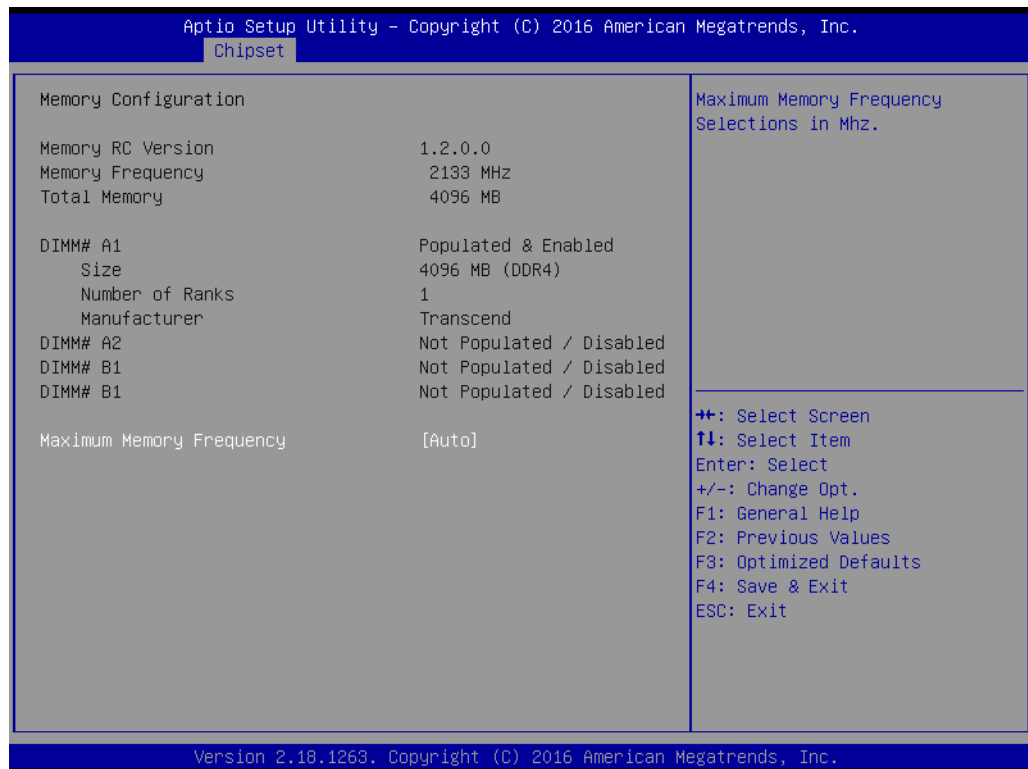

Figure 3.38 Memory Configuration

- **Maximum Memory Frequency**
Maximum memory frequency selections in Mhz.

3.2.3.5 PCH-IO Configuration

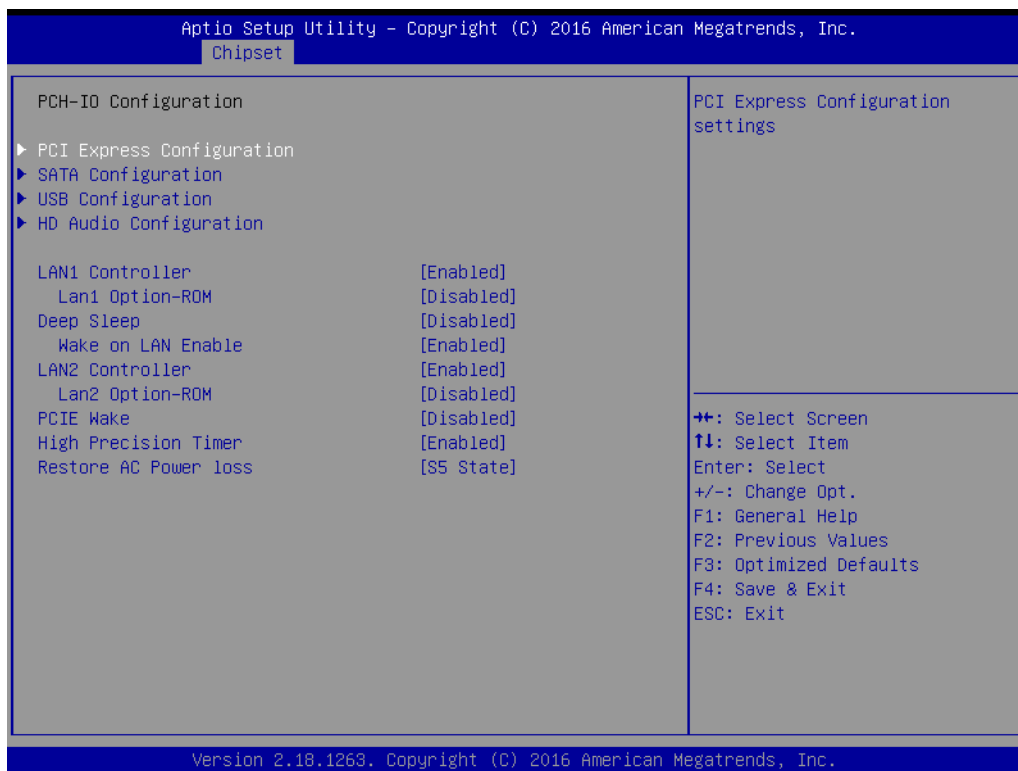
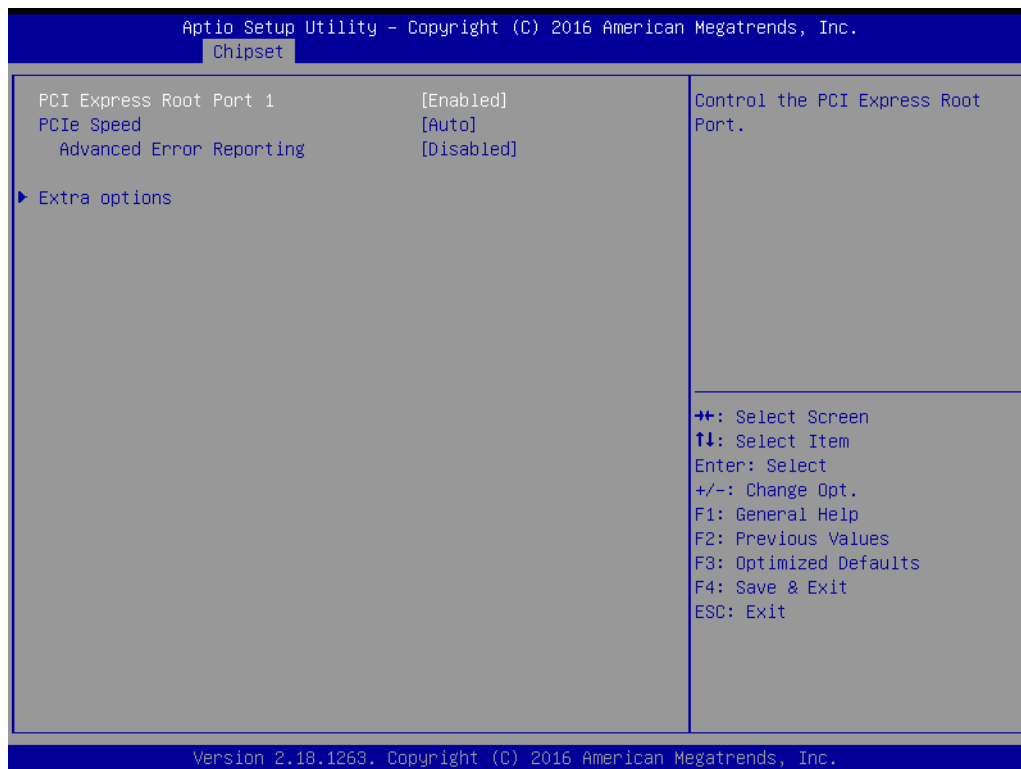
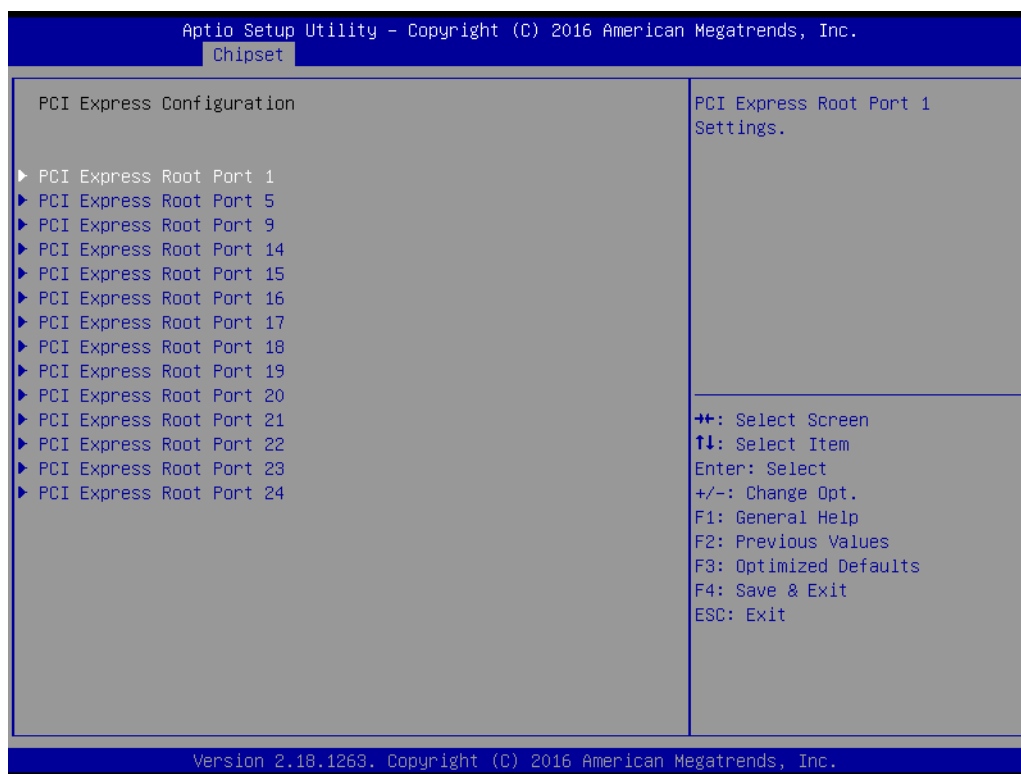

Figure 3.39 PCH-IO Configuration

- **LAN1 Controller**
"Enable or Disable" LAN1 controller.
- **LAN 1 Option-ROM**
"Enable or Disable" LAN 1 boot option for legacy network devices.
- **Deep Sleep**
"Enable or Disable" Deep Sleep.
- **Wake on LAN Enable**
"Enable or Disable" LAN1 to wake the system.
- **LAN2 Controller**
"Enable or Disable" LAN2 controller.
- **LAN 2 Option-ROM**
"Enable or Disable" LAN 2 boot option for legacy network devices.
- **PCIE Wake**
"Enable or Disable" PCIE to wake the system from S5.
- **High Precision timer**
"Enable or Disable" the high precision event timer
- **Restore AC Power Loss**
"Power off or Power on" or Last State to restore AC Power Loss

3.2.3.6 PCI Express Configuration

PCI Express Root Port 1 to 8 Setting.



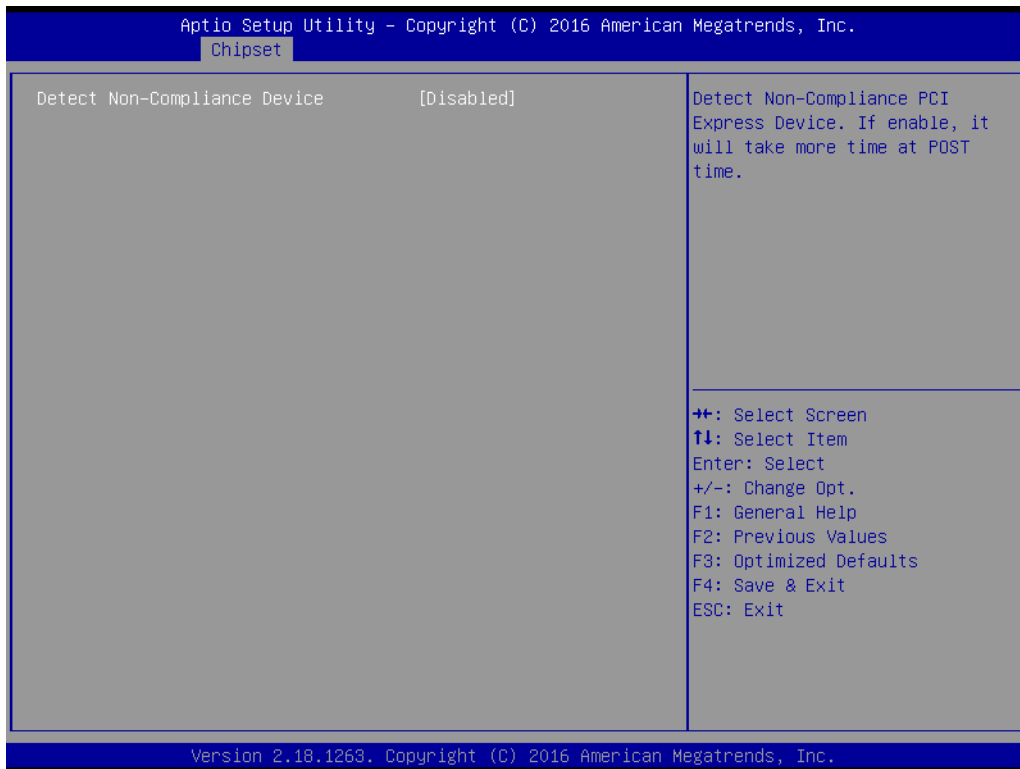

- **PCI Express Root Port 1**
Enable or Disable PCI Express Root Port.
- **PCIe Speed**
Select "Auto, Gen1, Gen2, Gen3" for PCIe Speed
- **Advanced Error Reporting**
"Enable or Disable" advanced error reporting
- **Detect Non-Compliance Device**
Detect Non-Compliance PCI Express Device. If enable, it will take more time at POST time.

3.2.3.7 SATA Configuration

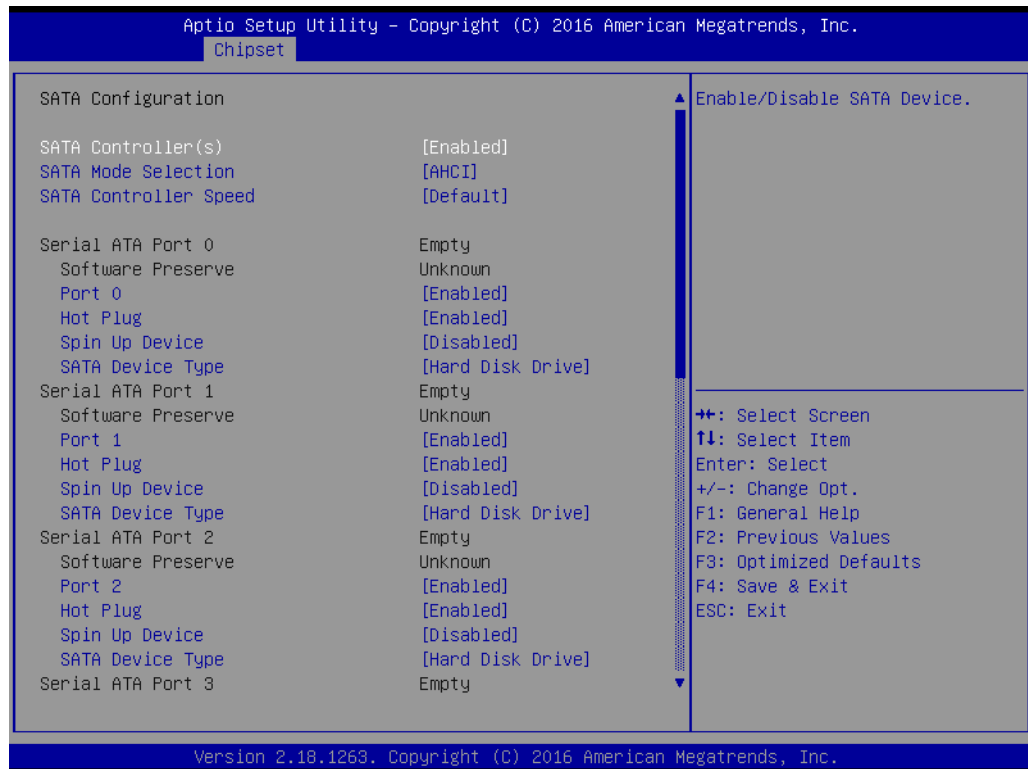

Figure 3.40 SATA Configuration

- **SATA Controller(s)**
"Enable or Disable" SATA Controller
- **SATA Mode Selection**
This can be configured as RAID or AHCI.
- **SATA Controller Speed**
Indicates the maximum speed the SATA controller can support by selecting "Default, Gen1, Gen2, Gen3".
- **Port 2~5**
"Enable or Disable" SATA port 2~5.
- **Hot Plug**
"Enable or Disable" SATA Hot-Plug
- **Spin up Device**
"Enable or Disable" spin up device
- **SATA Device Type**
To identify the SATA that is connected to a Solid State or Hard Disk Drive.

Note! Serial ATA Port 0 & 1 will not be shown in BIOS because these two ports are controlled by Marvel chip, not the Intel controller.



3.2.3.8 USB Configuration

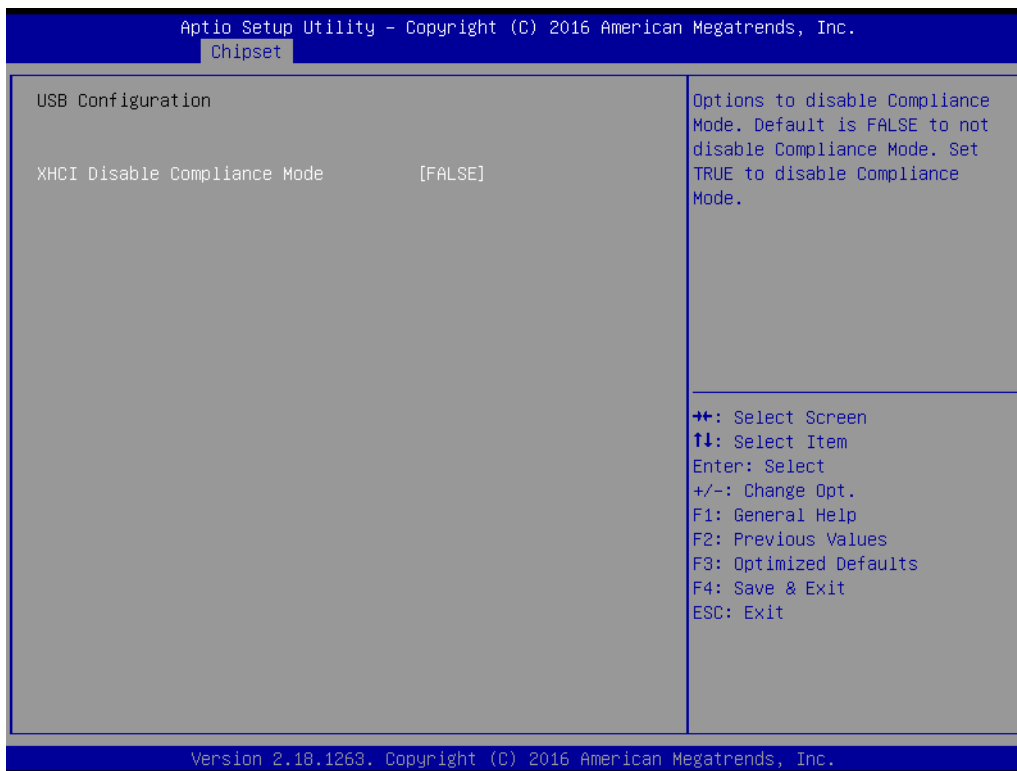

- **XHCI Disable Compliance mode**

Options to disable compliance mode. Default is FALSE enable compliance mode. Set TRUE to disable compliance mode.

3.2.3.9 HD Audio Configuration



■ **HD Audio**

Control detection of the HD-Audio device.

Disable = HDA will be unconditionally disabled

Enable=HDA will be unconditionally enabled

3.2.4 Security

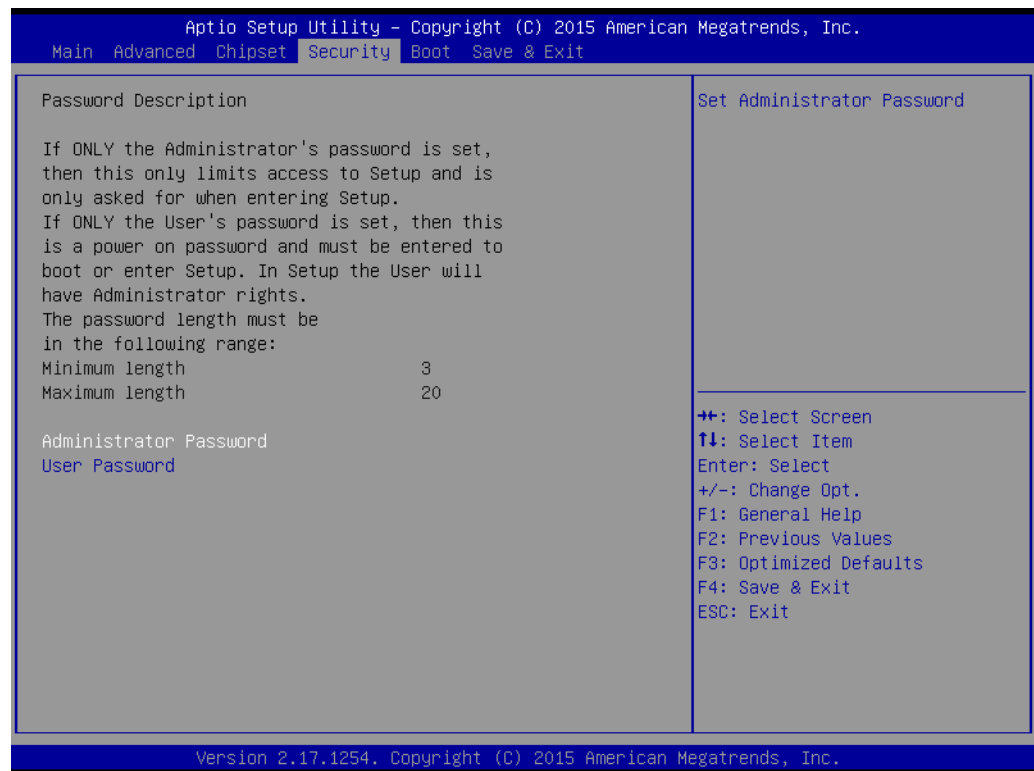

Figure 3.41 Security

Select Security Setup from the AIMB-785 Setup main BIOS setup menu. All Security Setup options, such as password protection is described in this section. To access the sub menu for the following items, select the item and press <Enter>.

Note! *If only the User's password is set, the User will have Administrator rights. To set Administrator password is strongly recommended if you have security concerns.*



3.2.5 Boot

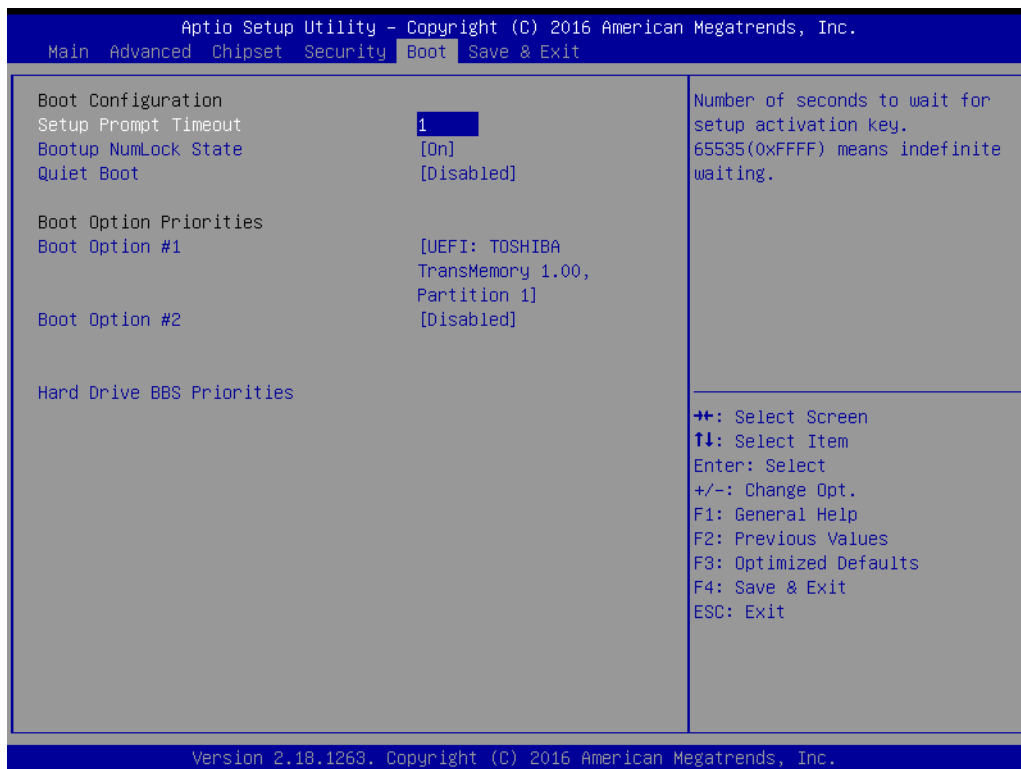

Figure 3.42 Boot

- **Setup Prompt Timeout**
Use the <+> and <-> keys to adjust the number of seconds to wait for setup activation key.
- **Bootup NumLock State**
“On or Off” power-on state for the NumLock
- **Quiet Boot**
“Enable or Disable” Quiet Boot option
- **Boot Option #1/2**
Sets the boot order
- **Hard Drive BBS Priorities**
Set the order of the legacy devices on this group

3.2.6 Save & Exit

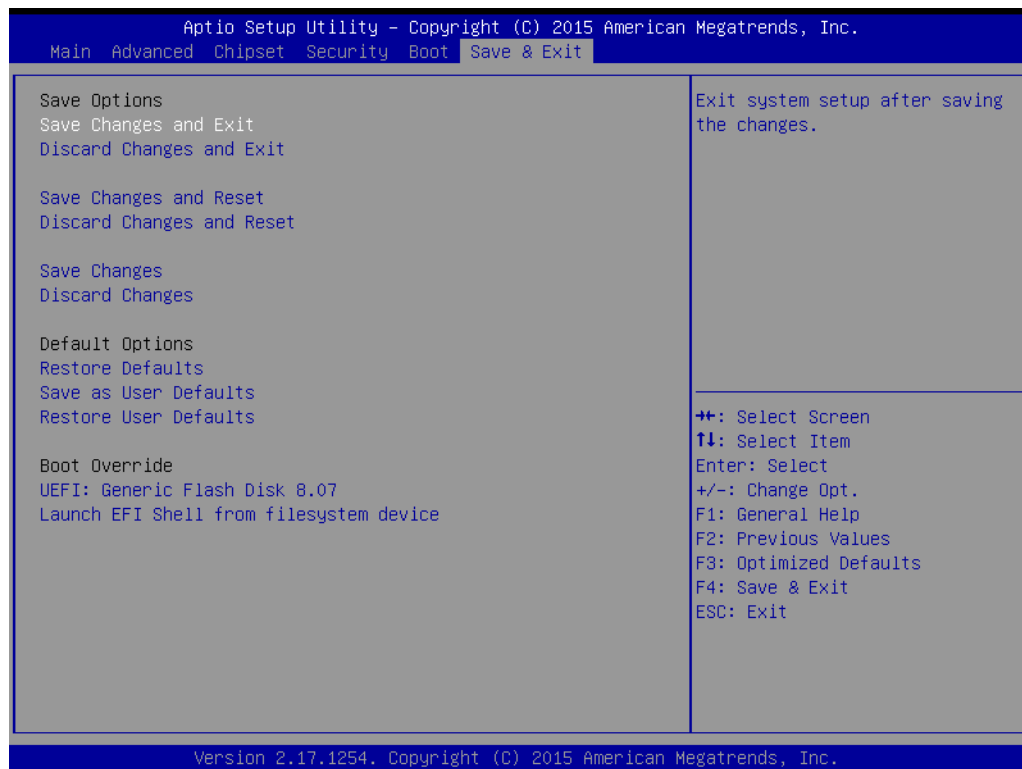

Figure 3.43 Save & Exit

Save Changes and Exit

When you complete system configuration, select this option to save your changes, exit BIOS setup and reboot the computer so the new system configuration parameters can take effect.

1. Select Exit Saving Changes from the Exit menu and press <Enter>. The following message appears:
Save Configuration Changes and Exit Now?
[Yes] [No]
2. Select Yes or No.

Discard changes and exit

Select this option to quit Setup without making any permanent changes to the system configuration.

1. Select Exit Discarding Changes from the Exit menu and press <Enter>. The following message appears:
Quit without saving?
[Yes] [No]
2. Select Yes to discard changes and exit.

Discard Changes

Select Discard Changes from the Exit menu and press <Enter>.

Chapter 4

Chipset Software
Installation Utility

4.1 Before you begin

To facilitate the installation of the enhanced display drivers and utility software, read the instructions in this chapter carefully. The drivers for the AIMB-785 are located on the software installation CD.

Note! *The files on the software installation CD are compressed. Do not attempt to install the drivers by copying the files manually. You must use the supplied SETUP program to install the drivers.*



Before you begin, it is important to note that most display drivers need to have the relevant software application already installed in the system prior to installing the enhanced display drivers. In addition, many of the installation procedures assume that you are familiar with both the relevant software applications and operating system commands. Review the relevant operating system commands and the pertinent sections of your application software's user manual before performing the installation.

4.2 Introduction

The Intel Chipset Software Installation (CSI) utility installs the Windows INF files that outline to the operating system how the chipset components will be configured. This is needed for the proper functioning of the following features:

- Core PCI PnP services
- Serial ATA interface support
- USB 1.1/2.0/3.0 support
- Identification of Intel chipset components in the Device Manager

Note! *The chipset driver is used for the following versions of Windows, and it has to be installed before installing all the other drivers. Intel 7th generation CPU supports Windows 10 (64-bit) only.*



- Windows 10 (64-bit)
- Windows 8.1 (32-bit)
- Windows 8.1 (64-bit)
- Windows 7 (32-bit)
- Windows 7 (64-bit)

Since xHCI driver is not natively supported in Windows 7, EHCI removal would impact Windows 7 in installing OS via USB sources. User may install Windows 7 via SATA ODD instead and then install USB 3.0 driver under OS, or place order of WES7 integrating Intel xHCI driver from Advantech.

4.3 Windows 10 / Windows 8.1 / Windows 7 Driver Setup

1. Insert the driver CD into your system's CD-ROM drive. You can see the driver folders items. Move the mouse cursor over the folder "01 Chipset". In CSI folder, you can click find an executable file to complete the implement of the driver



2. Click setup to execute program.

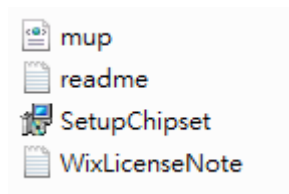

Chapter 5

Integrated Graphic
Device Setup

5.1 Introduction

The Intel processors are embedded with integrated graphics controller. You need to install the VGA driver to enable this function, which includes the following features:

- Optimized integrated graphic solution: With Intel Graphics Flexible Display Interface, it supports versatile display options and 32-bit 3D graphics engine. Triple independent display, enhanced display modes for widescreen flat panels for extend, twin, and clone dual display mode, and optimized 3D support delivers an intensive and realistic visual experience.

5.2 Windows 10/Windows 8.1/Windows 7 Driver Setup

Note! Before installing this driver, make sure the INF driver has been installed in your system. See Chapter 4 for information on installing the INF driver.



Insert the driver CD into your system's CD-ROM drive. You can see the driver folders items. Navigate to the "02 Graphic" folder and click the executable file to complete the installation of the drivers for Windows 7, Windows 8.1, Windows 10.

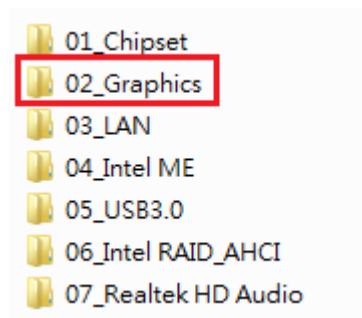

Chapter 6

LAN Configuration

6.1 Introduction

The AIMB-785 has dual Gigabit Ethernet LANs via dedicated PCI Express x1 lanes (Intel I219LM (LAN1) and I211AT (LAN2)) that offer bandwidth of up to 500 MB/sec, eliminating the bottleneck of network data flow and incorporating Gigabit Ethernet at 1000 Mbps.

6.2 Features

- 10/100/1000Base-T Ethernet controller
- 10/100/1000Base-T triple-speed MAC
- Full duplex at 10, 100, or 1000 Mbps and half duplex at 10 or 100 Mbps
- Wake-on-LAN (WOL) support
- PCIe x1 host interface

6.3 Installation

Note! Before installing the LAN drivers, make sure the CSI utility have been installed on your system. See Chapter 4 for information on installing the CSI utility.



The integrated Intel gigabit Ethernet controller supports all major network operating systems. However, the installation procedure varies with different operating systems. In the following sections, refer to the one that provides the driver setup procedure for the operating system you are using.

6.4 Win 10/Win 8.1/Win 7 Driver Setup (LAN)

Insert the driver CD into your system's CD-ROM drive. Select folder "03 LAN" then click the proper LAN driver for the OS.

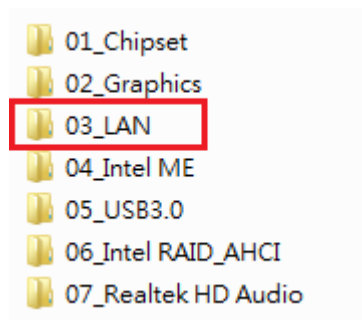

Chapter 7

Intel ME

7.1 Introduction

The Intel® ME software components that need to be installed depend on the system's specific hardware and firmware features. The installer detects the system's capabilities and installs the relevant drivers and applications.

7.2 Installation

Insert the driver CD into your system's CD-ROM drive. Navigate to the "04 Intel ME" folder to install the driver.

Note! *If the Intel® Management Engine (Intel® ME) driver has not been successfully installed, you may see an error on a "PCI Simple Communications Controller" in Device Manager.*



If you use Win7 OS, please install "Win7 update" folder first, and then reboot system to install ME driver.

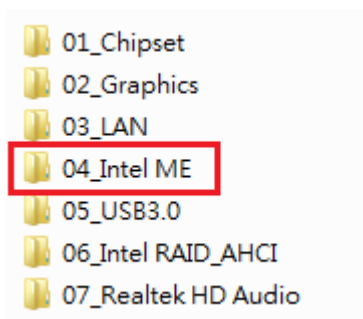

Chapter 8

Intel USB 3.0

8.1 Introduction

AIMB-785 provides Intel® USB 3.0 and the data transfer rate of USB3.0 (5Gb/s) is 10 times to USB2.0 (480 Mbps).

8.2 Installation

Insert the driver CD into your system's CD-ROM drive. Navigate to the "05 USB3.0" folder to install the driver.

Note!



The Intel® USB 3.0 eXtensible Host Controller Driver is native built in Windows 8. For these operating systems, ensure your BIOS settings have the xHCI Mode set to "Auto" or "Smart Auto". This will reconfigure the USB 3.0 ports to function as USB 2.0 ports using the native Windows EHCI driver.*

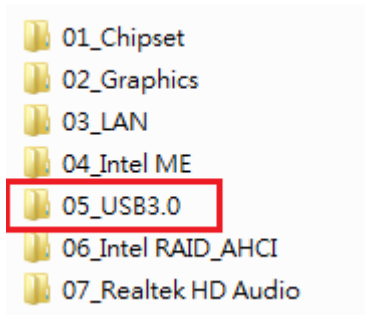

Chapter 9

SATA RAID Setup

9.1 Introduction

To support demanding disk I/O, Intel Q170 chipset integrates four Serial ATA controllers with software RAID 0, 1, 5, 10 capabilities.

RAID 0 striping increases the storage performance and is designed to speed up data transfer rates for disk-intensive applications.

RAID 1 mirroring protects valuable data that might be lost in the event of a hard drive failure.

RAID 5 array contains three or more hard drives where the data is divided into manageable blocks called strips. Parity is a mathematical method for recreating data that was lost from a single drive, which increases fault-tolerance. The data and parity are striped across all the hard drives in the array. The parity is striped in a rotating sequence to reduce bottlenecks associated with the parity calculations.

RAID 10 array uses four hard drives to create a combination of RAID levels 0 and 1. The data is striped across a two-drive array forming the RAID 0 component. Each of the drives in the RAID 0 array is then mirrored by a RAID 1 component.

9.2 SATA RAID Driver and Utility Setup

The installation utility is in the CD's "06 Intel RAID_AHCI" folder. You may go to the directory of the CD and follow the steps to install.

Chapter 10

HD Audio

10.1 Introduction

AIMB-785 is equipped with Realtek ALC892 Audio chip. It provides "Line-out" & "Microphone" two ports for any related applications.

10.2 Installation

The driver is on the DVD in the "07_Realtek HD Audio" folder. Navigate to the directory and follow the installation guide to install the driver and utility.

Appendix **A**

Programming the
Watchdog Timer

The AIMB-785's watchdog timer can be used to monitor system software operation and take corrective action if the software fails to function within the programmed period. This section describes the operation of the watchdog timer and how to program it.

A.1 Watchdog timer overview

The watchdog timer is built in to the super I/O controller NCT6776D. It provides the following functions for user programming:

- Can be enabled and disabled by user's program
- Timer can be set from 1 to 255 seconds
- Generates an interrupt or resets signal if the software fails to reset the timer before time-out

A.2 Programming the Watchdog Timer

The I/O port address of the watchdog timer is 2E (hex) and 2F (hex). 2E (hex) is the address port. 2F (hex) is the data port. You must first write an address value into address port 2E (hex), and then write/read data to/from the assigned register through data port 2F (hex).

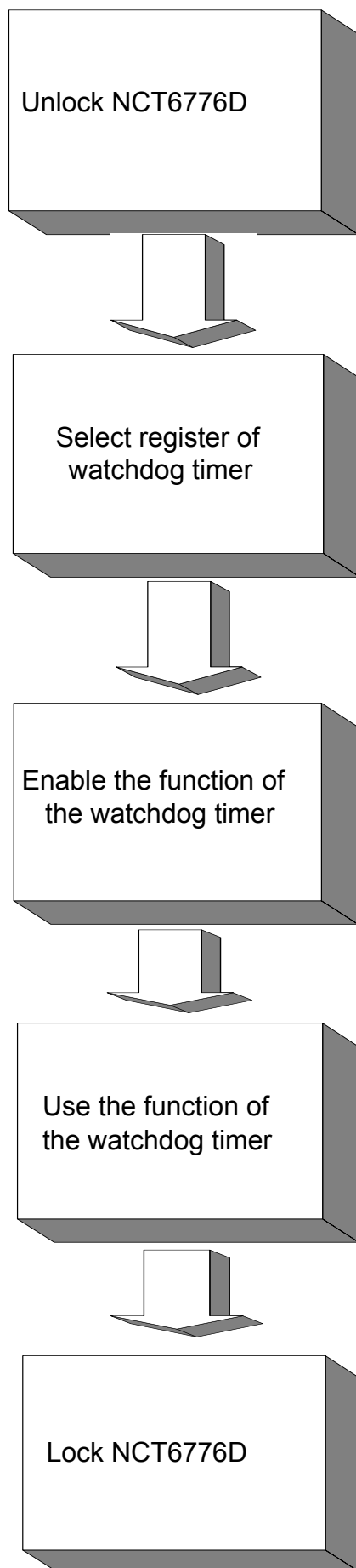

Table A.1: Watchdog timer registers

Address of register (2E)	Read/Write	Value (2F) & description
87 (hex)	-	Write this address to I/O address port 2E (hex) twice to unlock the NCT6776D
07 (hex)	write	Write 08 (hex) to select register of watchdog timer.
30 (hex)	write	Write 01 (hex) to enable the function of the watchdog timer. Disabled is set as default.
F5 (hex)	write	Set seconds or minutes as units for the timer. Write 0 to bit 3: set seconds as counting unit. [default]. Write 1 to bit 3: set minutes as counting unit. Write 1 to bit 4: Watchdog timer count mode is 1000 times faster. If bit 3 is 0, the count mode is 1/1000 seconds mode. If bit 3 is 1, the count mode is 1/1000 minutes mode.
F6 (hex)	write	0: stop timer [default] 01 ~ FF (hex): The amount of the count, in seconds or minutes, depends on the value set in register F5 (hex). This number decides how long the watchdog timer waits for strobe before generating an interrupt or reset signal. Writing a new value to this register can reset the timer to count with the new value.
F7 (hex)	read/write	Bit 6: Write 1 to enable keyboard to reset the timer, 0 to disable. [default] Bit 5: Write 1 to generate a timeout signal immediately and automatically return to 0. [default=0] Bit 4: Read status of watchdog timer, 1 means timer is "timeout".
AA (hex)	-	Write this address to I/O port 2E (hex) to lock NCT6776D.

A.2.1 Example Programs

Enable watchdog timer and set 10 seconds as the timeout interval

```

;-----
Mov dx,2eh ; Unlock NCT6776D
Mov al,87h
Out dx,al
Out dx,al
;-----
Mov al,07h ; Select registers of watchdog timer
Out dx,al
Inc dx
In al,dx
Or al,08h
Out dx,al
;-----
Dec dx; Enable the function of watchdog timer
Mov al,30h
Out dx,al
Inc dx
Mov al,01h
Out dx,al
;-----

```



```

Dec dx ; Set second as counting unit
Mov al,0f5h
Out dx,al
Inc dx
In al,dx
And al,not 08h
Out dx,al
;-----
Dec dx ; Set timeout interval as 10 seconds and start counting
Mov al,0f6h
Out dx,al
Inc dx
Mov al,10; 10 minutes
Out dx,al
;-----
Dec dx ; lock NCT6776D
Mov al,0aah
Out dx,al
Enable watchdog timer and set 5 minutes as the timeout interval
;-----
Mov dx,2eh ; unlock NCT6776D
Mov al,87h
Out dx,al
Out dx,al
;-----
Mov al,07h ; Select registers of watchdog timer
Out dx,al
Inc dx
In al,dx
Or al,08h
Out dx,al
;-----
Dec dx ; Enable the function of watchdog timer
Mov al,30h
Out dx,al
Inc dx
Mov al,01h
Out dx,al
;-----
Dec dx ; Set minute as counting unit
Mov al,0f5h
Out dx, al
Inc dx
In al,dx
Or al, 08h

```

```

Out dx,al
;-----
Dec dx ; Set timeout interval as 5 minutes and start counting
Mov al,0f6h
Out dx,al
Inc dx
Mov al,5; 5 minutes
Out dx,al
;-----
Dec dx ; lock NCT6776D
Mov al,0aah
Out dx,al
Enable watchdog timer to be reset by mouse
;-----
Mov dx,2eh ; unlock NCT6776D
Mov al,87h
Out dx,al
Out dx,al
;-----
Mov al,07h ; Select registers of watchdog timer
Out dx,al
Inc dx
Mov al,08h
Out dx,al
;-----
Dec dx ; Enable the function of watchdog timer
Mov al,30h
Out dx,al
Inc dx
In al,dx
Or al,01h
Out dx,al
;-----
Dec dx ; Enable watchdog timer to be reset by mouse
Mov al,0f7h
Out dx,al
Inc dx
In al,dx
Or al,80h
Out dx,al
;-----
Dec dx ; lock NCT6776D
Mov al,0aah
Out dx,al
Enable watchdog timer to be reset by keyboard

```

```

;-----
Mov dx,2eh ; unlock NCT6776D
Mov al,87h
Out dx,al
Out dx,al
;-----
Mov al,07h ; Select registers of watchdog timer
Out dx,al
Inc dx
Mov al,08h
Out dx,al
;-----
Dec dx ; Enable the function of watchdog timer
Mov al,30h
Out dx,al
Inc dx
Mov al,01h
Out dx,al
;-----
Dec dx ; Enable watchdog timer to be strobed reset by keyboard
Mov al,0f7h
Out dx,al
Inc dx
In al,dx
Or al,40h
Out dx,al
;-----
Dec dx ; lock NCT6776D
Mov al,0aah
Out dx,al
Generate a time-out signal without timer counting
;-----
Mov dx,2eh ; unlock NCT6776D
Mov al,87h
Out dx,al
Out dx,al
;-----
Mov al,07h ; Select registers of watchdog timer
Out dx,al
Inc dx
Mov al,08h
Out dx,al
;-----
Dec dx ; Enable the function of watchdog timer
Mov al,30h

```

```
Out dx,al
Inc dx
In al,dx
Or al,01h
Out dx,al
;-----
Dec dx ; Generate a time-out signal
Mov al,0f7h
Out dx,al ;Write 1 to bit 5 of F7 register
Inc dx
In al,dx
Or al,20h
Out dx,al
;-----
Dec dx ; lock NCT6776D
Mov al,0aah
Out dx,al
```

Appendix **B**

I/O Pin Assignments

B.1 Parallel Port (LPT1)

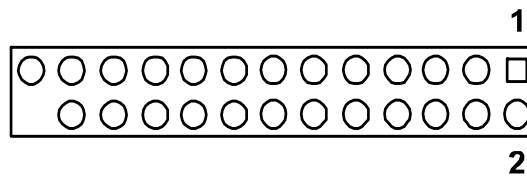

Table B.1: Parallel Port (LPT1)

Pin	Signal	Pin	Signal
1	STROBE#	14	AUTO-LINEFEED#
2	DATA0	15	ERROR#/FAULT#
3	DATA1	16	INITIALIZE#
4	DATA2	17	SELECT-PRINTER#/ SELECT-IN#
5	DATA3	18	GND
6	DATA4	19	GND
7	DATA5	20	GND
8	DATA6	21	GND
9	DATA7	22	GND
10	ACK#	23	GND
11	BUSY	24	GND
12	PAPER-OUT/ PAPER-END	25	GND
13	SELECT		

B.2 USB2.0 Type A Port (USB3)

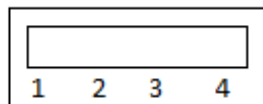
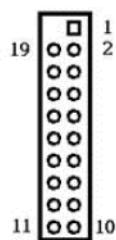

Table B.2: USB2.0 Type A Port (USB3)

Pin	Signal
1	+5V
2	D-
3	D+
4	GND

B.3 USB3.0 Header (USB1314)



Pin	Signal	Pin	Signal
1	+5V	2	STDA_SSRX-
3	STDA_SSRX+	4	GND
5	STDA_SSTX-	6	STDA_SSTX+
7	GND	8	D-
9	D+	10	OC#
11	D+	12	D-
13	GND	14	STDA_SSTX+
15	STDA_SSTX-	16	GND
17	STDA_SSRX+	18	STDA_SSRX-
19	+5V		

B.4 USB2.0 Header (USB56, USB78, USB1112)

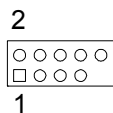

USB78

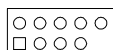

USB1112

Table B.3: USB2.0 Header (USB56, USB78, USB1112)

Pin	Signal	Pin	Signal
1	+5V	2	+5V
3	D-	4	D-
5	D+	6	D+
7	GND	8	GND
9	N/A	10	N/C

B.5 VGA Connector (VGA1)

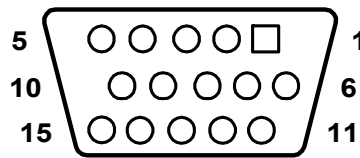

Table B.4: VGA Connector (VGA1)

Pin	Signal	Pin	Signal
1	RED	9	KEY/PWR
2	GREEN	10	GND
3	BLUE	11	ID0/RES
4	ID2/RES	12	ID1/SDA
5	GND	13	HSYNC
6	RED_RTN	14	VSYNC
7	GREEN_RTN	15	ID3/SCL
8	BLUE_RTN		

B.6 DVI Interface

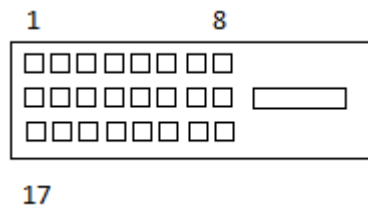

Table B.5: DVI-D Connector (DVI1/DVI2)

Pin	Signal	Pin	Signal
1	TMDS Data 2-	13	TMDS Data 3+
2	TMDS Data 2+	14	+5V
3	TMDS Data 2/4 shield	15	GND
4	TMDS Data 4-	16	Hot plug detect
5	TMDS Data 4+	17	TMDS data 0-
6	DDC clock	18	TMDS data 0+
7	DDC data	19	TMDS data 0/5 shield
8	Analog vertical sync	20	TMDS data 5-
9	TMDS Data 1-	21	TMDS data 5+
10	TMDS Data 1+	22	TMDS clock shield
11	TMDS Data 1/3 shield	23	TMDS clock+
12	TMDS Data 3-	24	TMDS clock-

B.7 RS-232 and COM3 Interface



Table B.6: RS-232 Interface (Rear)

Pin	Signal
1	DCD
2	RXD
3	TXD
4	DTR
5	GND
6	DSR
7	RTS
8	CTS
9	RI

Table B.7: RS-232 Interface (onboard)

Pin	Signal
1	DCD
2	DSR
3	RXD
4	RTS
5	TXD
6	CTS
7	DTR
8	RI
9	GND

Table B.8: COM3 Interface (onboard)

Pin	Signal
1	422/485 TX-
2	DSR
3	422/485 TX+
4	RTS
5	RX+
6	CTS
7	RX-
8	RI
9	GND

B.8 External Keyboard and Mouse Connector (KBMS1)

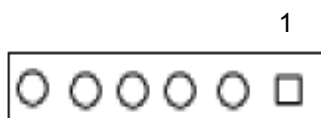

Table B.9: External Keyboard and Mouse Connector (KBMS2)

Pin	Signal
1	KB CLK
2	KB DATA
3	MS DATA
4	GND
5	KB/MS +5V
6	MS CLK

B.9 Infrared (IR) connector (JIR1) and JWDT1 and HW Monitor Alarm (JOBS1)

Table B.10: JIR1+JWDT1+JOBS1

Pin	Signal	Pin	Signal
1	+5V	6	SYSTEM RESET#
2	N/C	7	GND
3	N/C	8	ERROR_BEEP
4	WG#	9	IR TXD
5	IR RXD	10	OBS_BEEP

B.10 System Fan Power Connector (SYSFAN1/ SYSFAN2)



Table B.11: Fan Power Connector (SYSFAN1/SYSFAN2)

Pin	Signal
1	GND
2	+12 V
3	SENSE
4	PWM

B.11 Power LED and Keyboard Lock (JFP3)



Table B.12: Power LED and Keyboard Lock (JFP3)

Pin	Function
1	POWER_LED+
2	N/C
3	GND
4	KEYLOCK#
5	GND

B.12 External Speaker Connector (JFP2)



Table B.13: External Speaker Connector (JFP2)

Pin	Function
1	EXTENAL_SPK_P1
4	EXTENAL_SPK_2
7	INTENAL_SPK_P3
10	INTENAL_SPK_P4

B.13 Reset Connector (JFP1)

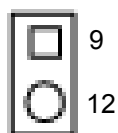

Table B.14: Reset Connector (JFP1)

Pin	Signal
9	SYSTEM RESET#
12	GND

B.14 HDD LED Connector (JFP2)

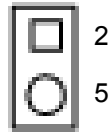

Table B.15: HDD LED Connector (JFP2)

Pin	Signal
2	HDD_LED+
5	SATA_LED+

B.15 ATX Soft Power Switch (JFP1)

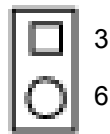

Table B.16: ATX Soft Power Switch (JFP1)

Pin	Signal
3	PANSWIN#
6	GND

B.16 SNMP SM_BUS Bus Connector (JFP2)

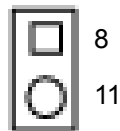
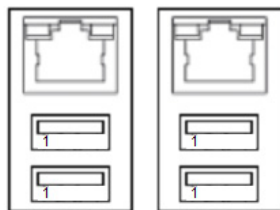

Table B.17: SM Bus Connector (JFP2)

Pin	Signal
8	W83782G_SDAT
11	W83782G_SCLK

B.17 USB/LAN ports (LAN1_USB910 and LAN2_USB12)



LAN1_USB910 LAN2_USB12

Table B.18: USB2.0 Port

Pin	Signal	Pin	Signal
1	+5V	3	D+
2	D-	4	GND

Table B.19: USB3.0 Port

Pin	Signal
1	+5V
2	D-
3	D+
4	GND
5	STDA_SSRX-
6	STDA_SSRX+
7	Shield GND_DRAIN
8	STDA_SSTX-
9	STDA_SSTX+

Table B.20: Giga LAN 10/100/1000 Base-T RJ-45 port

Pin	Signal	Pin	Signal
1	DA+	5	DC+
2	DA-	6	DC-
3	DB+	7	DD+
4	DB-	8	DD-

B.18 Line Out, MIC IN Connector (AUDIO)

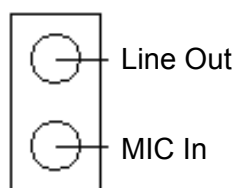

AUDIO

B.19 Front Panel Audio Connector (FPAUD1)

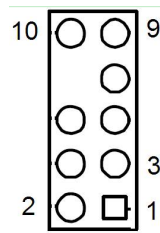

Table B.21: Front Panel Audio Connector (FPAUD1)

Pin	Signal
1	MIC-L
2	GND
3	MIC-R
4	PRESENSE#
5	LINE-R
6	MIC-JD
7	SENSE
8	N/A
9	LINE-L
10	LINE-JD

B.20 8-pin Alarm Board Connector (VOLT1)

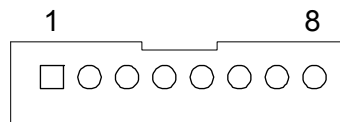

Table B.22: 8-pin Alarm Board Connector (VOLT1)

Pin	Signal	Pin	Signal
1	+5V_STBY	5	+5 V
2	GND	6	+3.3 V
3	GND	7	-12 V
4	-5 V	8	+12 V

B.21 Case Open Connector (JCASE1)

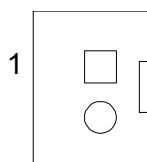

Table B.23: Case Open Connector (JCASE1)

Pin	Signal
1	CASEOP
2	GND

B.22 Front Panel LAN LED Connector (LAN_LED1)

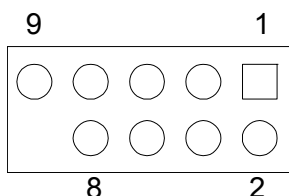

Table B.24: LAN LED Connector (LANLED1)

Pin	Signal	Pin	Signal
1	LAN_LED0_ACT#	2	LAN_LED0_ACT#
3	+3.3V	4	+3.3V
5	LAN_LED1_1G#	6	LAN_LED1_1G#
7	LAN_LED2_100M#	8	LAN_LED2_100M#
9	+3.3V		

B.23 SPI_CN1: SPI Flash Card Pin Connector

Table B.25: SPI_CN1:SPI fresh card pin connector

Pin	Signal	Pin	Signal
1	+V3.3V	2	GND
3	CS#	4	CLK
5	MISO	6	MOSI
7	N/A	8	N/C

B.24 Fixed I/O Ranges Decoded by Intel PCH

Table B.26: Fixed I/O Ranges Decoded by PCH

I/O Address	Read Target	Write Target	Internal Unit
00h–08h	DMA Controller	DMA Controller	DMA
00h–08h	DMA Controller	DMA Controller	DMA
09h–0Eh	RESERVED	DMA Controller	DMA
0Fh	DMA Controller	DMA Controller	DMA
10h–18h	DMA Controller	DMA Controller	DMA
19h–1Eh	RESERVED	DMA Controller	DMA
1Fh	DMA Controller	DMA Controller	DMA
20h–21h	Interrupt Controller	Interrupt Controller	Interrupt
24h–25h	Interrupt Controller	Interrupt Controller	Interrupt
28h–29h	Interrupt Controller	Interrupt Controller	Interrupt
2Ch–2Dh	Interrupt Controller	Interrupt Controller	Interrupt
2Eh–2Fh	LPC SIO	LPC SIO	Forwarded to LPC
30h–31h	Interrupt Controller	Interrupt Controller	Interrupt
34h–35h	Interrupt Controller	Interrupt Controller	Interrupt
38h–39h	Interrupt Controller	Interrupt Controller	Interrupt
3Ch–3Dh	Interrupt Controller	Interrupt Controller	Interrupt
40h–42h	Timer/Counter	Timer/Counter	PIT (8254)
43h	RESERVED	Timer/Counter	PIT
4Eh–4Fh	LPC SIO	LPC SIO	Forwarded to LPC
50h–52h	Timer/Counter	Timer/Counter	PIT
53h	RESERVED	Timer/Counter	PIT
60h	Microcontroller	Microcontroller	Forwarded to LPC
61h	NMI Controller	NMI Controller	Processor I/F
62h	Microcontroller	Microcontroller	Forwarded to LPC
64h	Microcontroller	Microcontroller	Forwarded to LPC
66h	Microcontroller	Microcontroller	Forwarded to LPC
70h	RESERVED1	NMI and RTC Controller	RTC
71h	RTC Controller	RTC Controller	RTC
72h	RTC Controller	NMI and RTC Controller	RTC
73h	RTC Controller	RTC Controller	RTC
74h	RTC Controller	NMI and RTC Controller	RTC
75h	RTC Controller	RTC Controller	RTC
76h	RTC Controller	NMI and RTC Controller	RTC
77h	RTC Controller	RTC Controller	RTC
80h	DMA Controller, LPC, PCI, or PCIe*	DMA Controller and LPC, PCI, or PCIe	DMA
81h–83h	DMA Controller	DMA Controller	DMA
84h–86h	DMA Controller	DMA Controller and LPC, PCI, or PCIe	DMA
87h	DMA Controller	DMA Controller	DMA

88h	DMA Controller	DMA Controller and LPC, PCI, or PCIe	DMA
89h–8Bh	DMA Controller	DMA Controller	DMA
8Ch–8Eh	DMA Controller	DMA Controller and LPC, PCI, or PCIe	DMA
8Fh	DMA Controller	DMA Controller	DMA
90h–91h	DMA Controller	DMA Controller	DMA
92h	Reset Generator	Reset Generator	Processor I/F
93h–9Fh	DMA Controller	DMA Controller	DMA
A0h–A1h	Interrupt Controller	Interrupt Controller	Interrupt
A4h–A5h	Interrupt Controller	Interrupt Controller	Interrupt
A8h–A9h	Interrupt Controller	Interrupt Controller	Interrupt
AC h–ADh	Interrupt Controller	Interrupt Controller	Interrupt
B0h–B1h	Interrupt Controller	Interrupt Controller	Interrupt
B2h–B3h	Power Management	Power Management	Power Management
B4h–B5h	Interrupt Controller	Interrupt Controller	Interrupt
B8h–B9h	Interrupt Controller	Interrupt Controller	Interrupt
BCh–BDh	Interrupt Controller	Interrupt Controller	Interrupt
C0h–D1h	DMA Controller	DMA Controller	DMA
D2h–DDh	RESERVED	DMA Controller	DMA
DEh–DFh	DMA Controller	DMA Controller	DMA
F0h	FERR# / Interrupt Controller	FERR# / Interrupt Controller	Processor I/F
170h–177h	SATA Controller, PCI, or PCIe	SATA Controller, PCI, or PCIe*	SATA
1F0h–1F7h	SATA Controller, PCI, or PCIe	SATA Controller, PCI, or PCIe	SATA
200h–207h	Gameport Low	Gameport Low	Forwarded to LPC
208h–20Fh	Gameport High	Gameport High	Forwarded to LPC
376h	SATA Controller, PCI, or PCIe	SATA Controller, PCI, or PCIe	SATA
3F6h	SATA Controller, PCI, or PCIe	SATA Controller, PCI, or PCIe	SATA
4D0h–4D1h	Interrupt Controller	Interrupt Controller	Interrupt
CF9h	Reset Generator	Reset Generator	Processor I/F

B.25 System I/O Ports

I/O Address (Hex)	Device
290h-29Fh	H/W Monitor
2F8h-2FFh	Communication Port (COM2)
378h-37Fh	Printer Port (LPT1)
3B0h-3BBh	Graphics
3C0h-3DFh	Graphics
3F8h-3FFh	Communication Port (COM1)
400h-47Fh	PMBASE
500h-57Fh	GPIOBASE
778h-77Fh	Printer Port (LPT1)
C80h-C9Fh	Communication Port (COM3~6)

B.26 DMA Channel Assignments

Table B.27: DMA channel assignments

Channel	Function
0	Available
1	Available
2	Available
3	Available
4	Cascade for DMA controller 1
5	Available
6	Available
7	Available

B.27 Interrupt Assignments

Table B.28: Interrupt assignments

Priority	Interrupt#	Interrupt source
1	NMI	Parity error detected
2	IRQ0	System timer
3	IRQ1	Keyboard
-	IRQ2	Interrupt from controller 2 (cascade)
4	IRQ8	Real-time clock
5	IRQ9	SCI IRQ
6	IRQ10	Available
7	IRQ11	COM3 ~ 6
8	IRQ12	PS/2 mouse
9	IRQ13	Numeric data processor
10	IRQ14	Available
11	IRQ15	Available
12	IRQ3	Communication port (COM2)
13	IRQ4	Communication port (COM1)
14	IRQ5	Available
15	IRQ6	Floppy
16	IRQ7	Parallel port 1 (print port)

B.28 1st MB Memory Map

Table B.29: 1st MB memory map

Addr. range (Hex)	Device
E0000h - FFFFFh	BIOS
CC000h - DFFFFh	Unused
C0000h - CBFFFh	VGA BIOS
A0000h - BFFFFh	Video Memory
00000h - 9FFFFh	Base memory

ADVANTECH

Enabling an Intelligent Planet

www.advantech.com

Please verify specifications before quoting. This guide is intended for reference purposes only.

All product specifications are subject to change without notice.

No part of this publication may be reproduced in any form or by any means, electronic, photocopying, recording or otherwise, without prior written permission of the publisher.

All brand and product names are trademarks or registered trademarks of their respective companies.

© Advantech Co., Ltd. 2017