



**dsPICDEM™ 1.1 Plus
Development Board
User's Guide**

Note the following details of the code protection feature on Microchip devices:

- Microchip products meet the specification contained in their particular Microchip Data Sheet.
- Microchip believes that its family of products is one of the most secure families of its kind on the market today, when used in the intended manner and under normal conditions.
- There are dishonest and possibly illegal methods used to breach the code protection feature. All of these methods, to our knowledge, require using the Microchip products in a manner outside the operating specifications contained in Microchip's Data Sheets. Most likely, the person doing so is engaged in theft of intellectual property.
- Microchip is willing to work with the customer who is concerned about the integrity of their code.
- Neither Microchip nor any other semiconductor manufacturer can guarantee the security of their code. Code protection does not mean that we are guaranteeing the product as "unbreakable."

Code protection is constantly evolving. We at Microchip are committed to continuously improving the code protection features of our products. Attempts to break Microchip's code protection feature may be a violation of the Digital Millennium Copyright Act. If such acts allow unauthorized access to your software or other copyrighted work, you may have a right to sue for relief under that Act.

Information contained in this publication regarding device applications and the like is provided only for your convenience and may be superseded by updates. It is your responsibility to ensure that your application meets with your specifications. MICROCHIP MAKES NO REPRESENTATIONS OR WARRANTIES OF ANY KIND WHETHER EXPRESS OR IMPLIED, WRITTEN OR ORAL, STATUTORY OR OTHERWISE, RELATED TO THE INFORMATION, INCLUDING BUT NOT LIMITED TO ITS CONDITION, QUALITY, PERFORMANCE, MERCHANTABILITY OR FITNESS FOR PURPOSE. Microchip disclaims all liability arising from this information and its use. Use of Microchip devices in life support and/or safety applications is entirely at the buyer's risk, and the buyer agrees to defend, indemnify and hold harmless Microchip from any and all damages, claims, suits, or expenses resulting from such use. No licenses are conveyed, implicitly or otherwise, under any Microchip intellectual property rights.

Trademarks

The Microchip name and logo, the Microchip logo, Accuron, dsPIC, KEELOQ, microID, MPLAB, PIC, PICmicro, PICSTART, PRO MATE, PowerSmart, rfPIC and SmartShunt are registered trademarks of Microchip Technology Incorporated in the U.S.A. and other countries.

AmpLab, FilterLab, Migratable Memory, MXDEV, MXLAB, SEEVAL, SmartSensor and The Embedded Control Solutions Company are registered trademarks of Microchip Technology Incorporated in the U.S.A.

Analog-for-the-Digital Age, Application Maestro, CodeGuard, dsPICDEM, dsPICDEM.net, dsPICworks, ECAN, ECONOMONITOR, FanSense, FlexROM, fuzzyLAB, In-Circuit Serial Programming, ICSP, ICEPIC, Linear Active Thermistor, Mindi, MiWi, MPASM, MPLIB, MPLINK, PICkit, PICDEM, PICDEM.net, PICLAB, PICTail, PowerCal, PowerInfo, PowerMate, PowerTool, REAL ICE, rFLAB, rfPICDEM, Select Mode, Smart Serial, SmartTel, Total Endurance, UNI/O, WiperLock and ZENA are trademarks of Microchip Technology Incorporated in the U.S.A. and other countries.

SQTP is a service mark of Microchip Technology Incorporated in the U.S.A.

All other trademarks mentioned herein are property of their respective companies.

© 2006, Microchip Technology Incorporated, Printed in the U.S.A., All Rights Reserved.

 Printed on recycled paper.

QUALITY MANAGEMENT SYSTEM
CERTIFIED BY DNV
== ISO/TS 16949:2002 ==

Microchip received ISO/TS-16949:2002 certification for its worldwide headquarters, design and wafer fabrication facilities in Chandler and Tempe, Arizona, Gresham, Oregon and Mountain View, California. The Company's quality system processes and procedures are for its PIC® 8-bit MCUs, KEELOQ® code hopping devices, Serial EEPROMs, microperipherals, nonvolatile memory and analog products. In addition, Microchip's quality system for the design and manufacture of development systems is ISO 9001:2000 certified.

Table of Contents

Preface 1

Chapter 1. Introduction

 1.1 Introduction 9

 1.2 Highlights 9

 1.3 dsPICDEM™ 1.1 Plus DEVELOPMENT BOARD Kit 9

 1.4 dsPICDEM™ 1.1 Plus Development Board Features 10

 1.5 Supported Plug-In Modules 11

 1.6 Running the dsPICDEM™ 1.1 Plus Demonstration Program 12

Chapter 2. Using dsPIC30F Devices

 2.1 Introduction 13

 2.2 Highlights 13

 2.3 Tutorial Overview 13

 2.4 Creating the Project 14

 2.5 Building the Code 19

 2.6 Programming the Chip 21

 2.7 Debugging the Code 25

Chapter 3. dsPIC30F Demonstration Program Operation

 3.1 Introduction 29

 3.2 Highlights 29

 3.3 Demonstration Program Operation 29

 3.4 Data and Control Flow 36

 3.5 dsPIC30F Demonstration Performance Metrics 39

 3.6 Board Self-Test Code Module Summary 42

Chapter 4. Using dsPIC33F and PIC24H/24F Devices

 4.1 Introduction 43

 4.2 Highlights 43

 4.3 Tutorial Overview 43

 4.4 Creating the Project 44

 4.5 Building the Code 49

 4.6 Programming the Chip 51

 4.7 Debugging the Code 55

 4.8 Additional Code Examples 59

Chapter 5. dsPICDEM™ 1.1 Development Hardware

 5.1 dsPICDEM™ 1.1 Plus Development Board Hardware Overview 61

dsPICDEM™ 1.1 Plus Development Board User's Guide

Appendix A. Hardware Drawings and Schematics

A.1 Introduction	67
A.2 Highlights	67

Appendix B. LCD Controller Specification

B.1 Overview	75
B.2 LCD Controller Interface	75
B.3 Commands	76
B.4 General Commands	78
B.5 Character commands	79
B.6 Pixel commands	81
B.7 Column commands	82
B.8 Examples	83

Index	85
--------------------	-----------

Worldwide Sales and Service	88
--	-----------



dsPICDEM™ 1.1 PLUS DEVELOPMENT BOARD

Preface

NOTICE TO CUSTOMERS

All documentation becomes dated, and this manual is no exception. Microchip tools and documentation are constantly evolving to meet customer needs, so some actual dialogs and/or tool descriptions may differ from those in this document. Please refer to our web site (www.microchip.com) to obtain the latest documentation available.

Documents are identified with a “DS” number. This number is located on the bottom of each page, in front of the page number. The numbering convention for the DS number is “DSXXXXA”, where “XXXX” is the document number and “A” is the revision level of the document.

For the most up-to-date information on development tools, see the MPLAB® IDE on-line help. Select the Help menu, and then Topics to open a list of available on-line help files.

INTRODUCTION

This chapter contains general information that will be useful to know before using the dsPICDEM™ 1.1 Plus Development Board. Items discussed in this chapter include:

- About This Guide
- Conventions Used in this Guide
- Warranty Registration
- Recommended Reading
- The Microchip Web Site
- Development Systems Customer Change Notification Service
- Customer Support
- Document Revision History

ABOUT THIS GUIDE

This document describes how to use the dsPICDEM™ 1.1 Plus Development Board as a development tool to emulate and debug firmware on a target board. The manual layout is as follows:

- **Chapter 1: Introduction** – This chapter introduces the dsPICDEM™ 1.1 Plus Development Board and provides a brief description of the hardware.
- **Chapter 2: Using dsPIC30F Devices** – This chapter goes through a basic step-by-step process for getting your dsPICDEM™ 1.1 Plus Development Board up and running with the MPLAB® In-Circuit Debugger 2 (ICD 2) using dsPIC30F devices.
- **Chapter 3: Demonstration Program Operation** – This chapter presents a detailed description of the operational functionality of the sample code, which is preprogrammed into the dsPIC30F device.

dsPICDEM™ 1.1 Plus Development Board User's Guide

- **Chapter 4. Using dsPIC33F/PIC24H Devices** – This chapter goes through a basic step-by-step process for getting your dsPICDEM™ 1.1 Plus Development Board up and running with the MPLAB® ICD 2 using dsPIC30F devices.
- **Chapter 5: dsPICDEM™ 1.1 Plus Development Board Hardware** – This chapter presents the features of the dsPICDEM™ 1.1 Plus Development Board in more detail.
- **Appendix A: Hardware Drawings and Schematics** – This Appendix illustrates the dsPICDEM™ 1.1 Plus Development Board layout and hardware schematic diagrams.
- **Appendix B: LCD Controller Specification** – This section presents the 122 x 32 Graphics LCD Controller Interface Specifications.
- **Index** – This section provides cross-reference listing of terms, features and sections of this document.
- **Worldwide Sales and Service** – A listing of Microchip sales and service locations and telephone numbers worldwide.

CONVENTIONS USED IN THIS GUIDE

This manual uses the following documentation conventions:

DOCUMENTATION CONVENTIONS

Description	Represents	Examples
Arial font:		
Italic characters	Referenced books	<i>MPLAB[®] IDE User's Guide</i>
	Emphasized text	...is the <i>only</i> compiler...
Initial caps	A window	the Output window
	A dialog	the Settings dialog
	A menu selection	select Enable Programmer
Quotes	A field name in a window or dialog	"Save project before build"
Underlined, italic text with right angle bracket	A menu path	<u><i>File>Save</i></u>
Bold characters	A dialog button	Click OK
	A tab	Click the Power tab
N'Rnnnn	A number in verilog format, where N is the total number of digits, R is the radix and n is a digit.	4'b0010, 2'hF1
Text in angle brackets < >	A key on the keyboard	Press <Enter>, <F1>
Courier New font:		
Plain Courier New	Sample source code	#define START
	Filenames	autoexec.bat
	File paths	c:\mcc18\h
	Keywords	_asm, _endasm, static
	Command-line options	-Opa+, -Opa-
	Bit values	0, 1
	Constants	0xFF, 'A'
Italic Courier New	A variable argument	<i>file.o</i> , where <i>file</i> can be any valid filename
Square brackets []	Optional arguments	mcc18 [options] <i>file</i> [options]
Curly brackets and pipe character: { }	Choice of mutually exclusive arguments; an OR selection	errorlevel {0 1}
Ellipses...	Replaces repeated text	var_name [, var_name...]
	Represents code supplied by user	void main (void) { ... }

dsPICDEM™ 1.1 Plus Development Board User's Guide

WARRANTY REGISTRATION

Please complete the enclosed Warranty Registration Card and mail it promptly. Sending in the Warranty Registration Card entitles users to receive new product updates. Interim software releases are available at the Microchip web site.

RECOMMENDED READING

This user's guide describes how to use the dsPICDEM™ 1.1 Plus Development Board. Other useful documents are listed below:

dsPIC30F Family Reference Manual (DS70046)

Consult this document for detailed information on the dsPIC30F device operation. The manual explains the operation of the dsPIC30F MCU family architecture and peripheral modules but does not cover the specifics of each device. Refer to the appropriate device data sheet, mentioned below, for device-specific information.

dsPIC30F/33F Programmer's Reference Manual (DS70157)

This manual is a software developer's reference for the dsPIC30F/33F 16-bit MCU device families. This manual describes the instruction set in detail and also provides general information to assist the user in developing software for the dsPIC30F MCU family.

dsPIC30F Family Overview (DS70043)

This document provides an overview of the features and functionality of the dsPIC® DSC product family. It helps determine how the dsPIC 16-bit Digital Signal Controller Family fits a specific product application. For detailed information about any of the functionality, refer to the "*dsPIC30F Family Reference Manual*" (DS70046).

PIC24H Family Data Sheet (DS70175)

This data sheet summarizes the features of the PIC24H family of devices. It provides essential information needed to develop software for these devices.

dsPIC33F Family Data Sheet (DS70165)

This data sheet summarizes the features of the dsPIC33F family of devices. It provides essential information needed to develop software for these devices.

MPLAB® ASM30, MPLAB® LINK30 and Utilities User's Guide (DS51317)

This document details Microchip Technology's language tools for dsPIC DSC devices based on GNU technology. The language tools discussed are:

- MPLAB ASM30 Assembler
- MPLAB LINK30 Linker
- MPLAB LIB30 Archiver/Librarian
- Other Utilities

MPLAB® C30 C Compiler User's Guide (DS51284)

The purpose of this document is to help you use Microchip's MPLAB C30 C compiler for dsPIC® DSC devices to develop your application. MPLAB C30 is a GNU-based language tool, based on source code from the Free Software Foundation (FSF). For more information about the FSF, see www.fsf.org.

Other GNU language tools available from Microchip are:

- MPLAB ASM30 Assembler
- MPLAB LINK30 Linker
- MPLAB LIB30 Librarian/Archiver

MPLAB IDE Simulator, Editor User's Guide (DS51025)

Consult this document for more information pertaining to the installation and features of the MPLAB Integrated Development Environment (IDE) Software.

To obtain any of these documents, contact the nearest Microchip sales location (see back page) or visit the Microchip web site at: www.microchip.com.

dsPICDEM™ 1.1 Plus Development Board User's Guide

THE MICROCHIP WEB SITE

Microchip provides online support via our web site at www.microchip.com. This web site is used as a means to make files and information easily available to customers. Accessible by using your favorite Internet browser, the web site contains the following information:

- **Product Support** – Data sheets and errata, application notes and sample programs, design resources, user's guides and hardware support documents, latest software releases and archived software
- **General Technical Support** – Frequently Asked Questions (FAQs), technical support requests, online discussion groups, Microchip consultant program member listing
- **Business of Microchip** – Product selector and ordering guides, latest Microchip press releases, listing of seminars and events, listings of Microchip sales offices, distributors and factory representatives

DEVELOPMENT SYSTEMS CUSTOMER CHANGE NOTIFICATION SERVICE

Microchip's customer notification service helps keep customers current on Microchip products. Subscribers will receive e-mail notification whenever there are changes, updates, revisions or errata related to a specified product family or development tool of interest.

To register, access the Microchip web site at www.microchip.com, click on Customer Change Notification and follow the registration instructions.

The Development Systems product group categories are:

- **Compilers** – The latest information on Microchip C compilers and other language tools. These include the MPLAB C18 and MPLAB C30 C compilers; MPASM™ and MPLAB ASM30 assemblers; MPLINK™ and MPLAB LINK30 object linkers; and MPLIB™ and MPLAB LIB30 object librarians.
- **Emulators** – The latest information on Microchip in-circuit emulators. This includes the MPLAB ICE 2000 and MPLAB ICE 4000.
- **In-Circuit Debuggers** – The latest information on the Microchip in-circuit debugger, MPLAB ICD 2.
- **MPLAB® IDE** – The latest information on Microchip MPLAB IDE, the Windows® Integrated Development Environment for development systems tools. This list is focused on the MPLAB IDE, MPLAB SIM simulator, MPLAB IDE Project Manager and general editing and debugging features.
- **Programmers** – The latest information on Microchip programmers. These include the MPLAB PM3 and PRO MATE® II device programmers and the PICSTART® Plus and PICkit™ 1 development programmers.

CUSTOMER SUPPORT

Users of Microchip products can receive assistance through several channels:

- Distributor or Representative
- Local Sales Office
- Field Application Engineer (FAE)
- Technical Support

Customers should contact their distributor, representative or field application engineer (FAE) for support. Local sales offices are also available to help customers. A listing of sales offices and locations is included in the back of this document.

Technical support is available through the web site at: <http://support.microchip.com>

DOCUMENT REVISION HISTORY

Revision D (October 2006)

This revision reflects an upgrade to the dsPICDEM™ 1.1 Plus Development Board to allow it to accommodate dsPIC30F, dsPIC33F, PIC24H and PIC24F devices.

- Changed board name to dsPICDEM™ 1.1 Plus Development Board.
- Modified power supply circuits to accommodate both 3.3 V and 5V devices.
- Added tutorial and code examples for using the dsPICDEM™ 1.1 Plus Development Board with dsPIC33F and PIC24H/F devices (see **Chapter 4. “Using dsPIC33F and PIC24H/24F Devices”**).

Revision C (September 2005)

- Last Release of this Document.
- Previous releases contained Advance Information that was updated in Revision C.

dsPICDEM™ 1.1 Plus Development Board User's Guide

NOTES:

Chapter 1. Introduction

1.1 INTRODUCTION

The dsPICDEM™ 1.1 Plus Development Board Kit serves as a development and evaluation tool for dsPIC30F/33F High Performance Digital Signal Controllers and PIC24H/24F PIC® microcontrollers.

1.2 HIGHLIGHTS

This chapter discusses:

- dsPICDEM™ 1.1 Plus Development Board Kit
- dsPICDEM™ 1.1 Plus Development Board Features
- Supported Plug-In Modules
- Running the dsPICDEM™ 1.1 Demonstration Program

1.3 dsPICDEM™ 1.1 PLUS DEVELOPMENT BOARD KIT

The dsPICDEM™ 1.1 Plus Development Board Kit contains the following items:

- The dsPICDEM™ 1.1 Plus Printed Circuit Board (Figure 1-1)
- Preprogrammed dsPIC30F6014A Plug-in Module (Figure 1-2)
- 9V DC Power Supply
- RS-232 Interface Cable
- dsPICDEM™ 1.1 Plus Development Board Kit CD containing demonstration programs

FIGURE 1-1: dsPICDEM™ 1.1 PLUS DEVELOPMENT BOARD

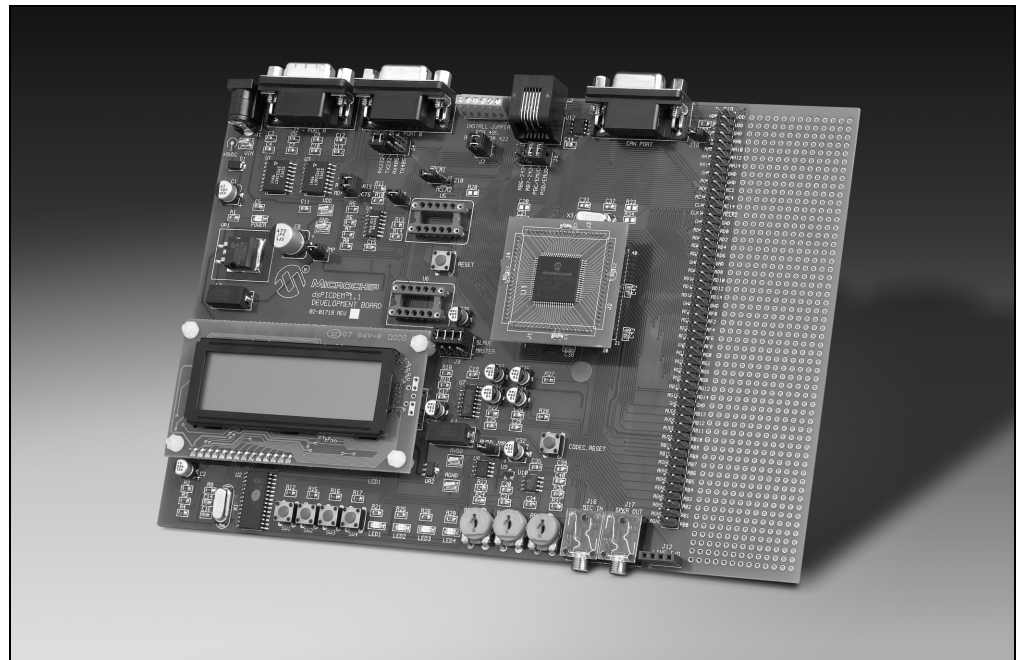

Voice Band Codec

- Si3000 Voice band Codec chip (U7)
- Jumper J9 for selection of Si3000 Codec mode (Master/Slave)
- Socket U6, optional clock oscillator for Si3000 Voice band Codec
- 4-pin header for the Codec Line In and Line Out
- One 3.5 mm phono jack for the Codec left and right speaker outputs
- One 3.5 mm phono jack for the Codec MIC input
- Codec reset push button switch

Analog

- Three 5 k Ω Potentiometers (RP1-RP3)
- Microchip TC1047A Thermal Sensor (U9)
- MCP41010 Digital Potentiometer (U8)
- MCP602 Operational Amplifiers configured as low-pass filters for temperature sensor and digital potentiometer (U10)

Device Clocking

- 7.3728 MHz crystal (X3) for dsPIC DSC device
- Socket U5, clock oscillator for dsPIC DSC device (alternate clock source, X3 removed)
- Pad for 32.768 kHz crystal (X2) and load caps

Miscellaneous

- Reset push button switch and jumper (J10) for resetting the PIC18F242 LCD controller or the dsPIC DSC device
- Four red LEDs (LED1-LED4)
- Four push button switches (SW1-SW4) for external input stimulus
- 122 x 32 dot addressable LCD
- PIC18F242 LCD controller
- 2 x 50 prototyping header for user hardware expansion (header not installed)
- Prototype area for user hardware

1.5 SUPPORTED PLUG-IN MODULES

The dsPICDEM™ 1.1 Plus Development Board supports these Plug-In Modules:

- dsPIC30F6014A 80L Plug-In Module (MA300014)
- dsPIC33FJ256GP710 100-to-80L Plug-In Module (MA330012)

1.6 RUNNING THE dsPICDEM™ 1.1 PLUS DEMONSTRATION PROGRAM

The dsPICDEM™ 1.1 Plus Development Board is supplied with a pre-loaded demonstration program that exercises principal CPU functions and peripheral options that interact with typical user application programs.

When you apply power to the dsPICDEM™ 1.1 Plus Development Board, the LCD menu displays these demonstration functions:

- Data Acquisition Display
- Digital Signal Processing (DSP) Operations
- Dual Tone Multi-Frequency (DTMF) Generation

Switches SW2-SW4 select one of these three choices. Each choice offers a submenu, which provides for additional options using switches SW1-SW4.

Refer to **Chapter 3. “dsPIC30F Demonstration Program Operation”** for full details on the demonstration code operation.

Chapter 2. Using dsPIC30F Devices

2.1 INTRODUCTION

This chapter is a self-paced tutorial to get you started using the dsPICDEM™ 1.1 Plus Development Board with dsPIC30F devices. The tutorial demonstrates the main features of MPLAB IDE Integrated Development Environment and the MPLAB ICD 2 In-Circuit Debugger as they are used with the dsPICDEM™ 1.1 Plus Development Board. Upon completing this tutorial, you should be able to:

- Create a project using the Project Wizard.
- Assemble and link the code and set the Configuration bits.
- Set up MPLAB IDE to use the MPLAB ICD 2 In-Circuit Debugger.
- Program the chip with the MPLAB ICD 2.
- View the code execution in program memory and source code.
- View registers in a Watch window.
- Set a breakpoint and make the code halt at a chosen location.
- Use the function keys to Reset, Run, Halt and Single Step the code.

2.2 HIGHLIGHTS

Items discussed in this chapter include:

- Tutorial Overview
- Creating the Project
- Building the Code
- Programming the Chip
- Debugging the Code

2.3 TUTORIAL OVERVIEW

The tutorial program in `Tut6014a.s` (included with the CD-ROM) is written in assembly code. This program displays text on the LCD and flashes an LED. The source file is used with a linker script file (`p30f6014a.gld`) and an include file (`p30f6014a.inc`) to form a complete project. The tutorial is a simple project that uses a single source code file. More complex projects might use multiple assembler and compiler source files as well as library files and precompiled object files. For simplicity, this tutorial uses only one source file.

There are four steps to this tutorial:

1. Create a project in MPLAB IDE.
2. Assemble and link the code.
3. Program the chip with the MPLAB ICD 2.
4. Debug the code with the MPLAB ICD 2.

2.4 CREATING THE PROJECT

The first step is to create a project and a workspace in MPLAB IDE. Usually, you will have one project in one workspace.

Note: These instructions presume the use of MPLAB 7.20 or newer.

A project contains the files needed to build an application (source code, linker script files, etc.) along with their associations to various build tools and build options.

A workspace contains one or more projects and information on the selected device, debug tool and/or programmer, open windows and their location and other IDE configuration settings.

MPLAB IDE contains a Project Wizard to help create new projects. Before starting, create a folder for the project files for this tutorial (C:\Tutorial is assumed in the instructions that follow). From the dsPICDEM 1_1 Plus Development Board code\Tutorial Code folder on the dsPICDEM™ 1.1 Plus Development Kit CD, copy the Tut6014a.s file into the C:\Tutorial folder.

Note: All files copied from the CD are read only. If the file needs to be edited, the attributes will need to be changed.

2.4.1 Select a Device

1. Start MPLAB IDE.
2. Close any workspace that might be open (*File>Close Workspace*).
3. From the *Project* menu, select *Project Wizard*.
4. From the Welcome screen, click **Next>** to display the Project Wizard Step One dialog (see Figure 2-1).

FIGURE 2-1: PROJECT WIZARD, STEP 1, SELECT A DEVICE

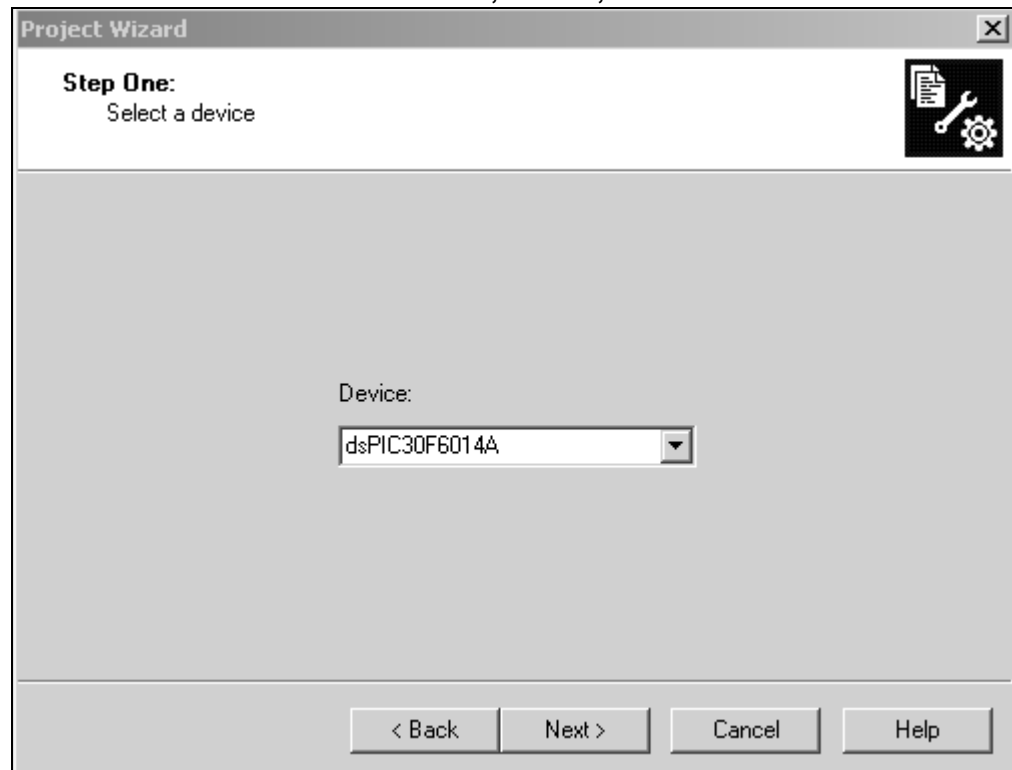

- From the **Device:** pull-down list, select dsPIC30F6014A and click **Next>**. The Project Wizard Step Two dialog displays (see Figure 2-2).

FIGURE 2-2: PROJECT WIZARD, STEP 2, SELECT LANGUAGE TOOLSUITE

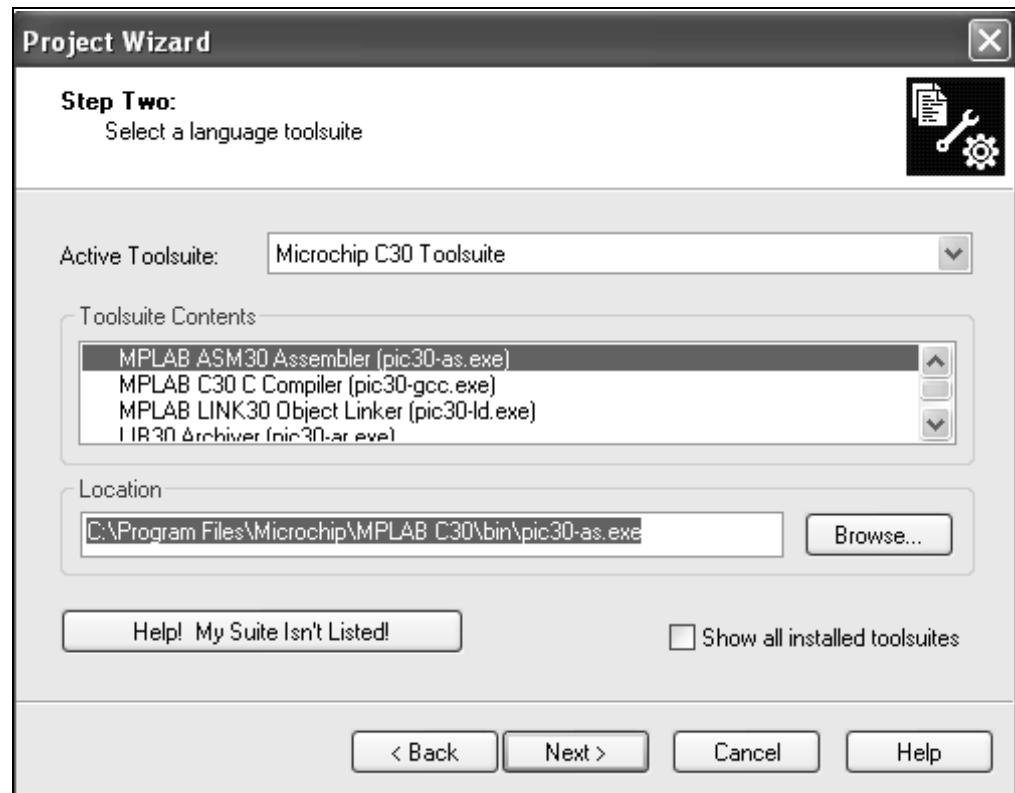

2.4.2 Select Language Toolsuite

- From the **Active Toolsuite:** pull-down menu, select **Microchip C30 Toolsuite**. This toolsuite includes the assembler and linker that will be used (the C Compiler is not used).

Note: Steps 2-4 are optional.

- In the **Toolsuite Contents** block, select **MPLAB ASM30 Assembler (pic30-as.exe)**.
- In the **Location** block, click **Browse...** and navigate to:
C:\Program Files\Microchip\MPLAB ASM30 Suite
\bin\pic30-as.exe
- With **MPLAB LINK 30 Object Linker (pic30-ld.exe)** selected in **Toolsuite Contents**, click **Browse...** and navigate to:
C:\Program Files\Microchip\MPLAB ASM30 Suite
\bin\pic30-ld.exe
- Click **Next>** to continue. The Project Wizard Step Three dialog displays (see Figure 2-3).

Note: The tool locations for your environment may be different from those shown in this tutorial.

FIGURE 2-3: PROJECT WIZARD, STEP 3, NAME YOUR PROJECT

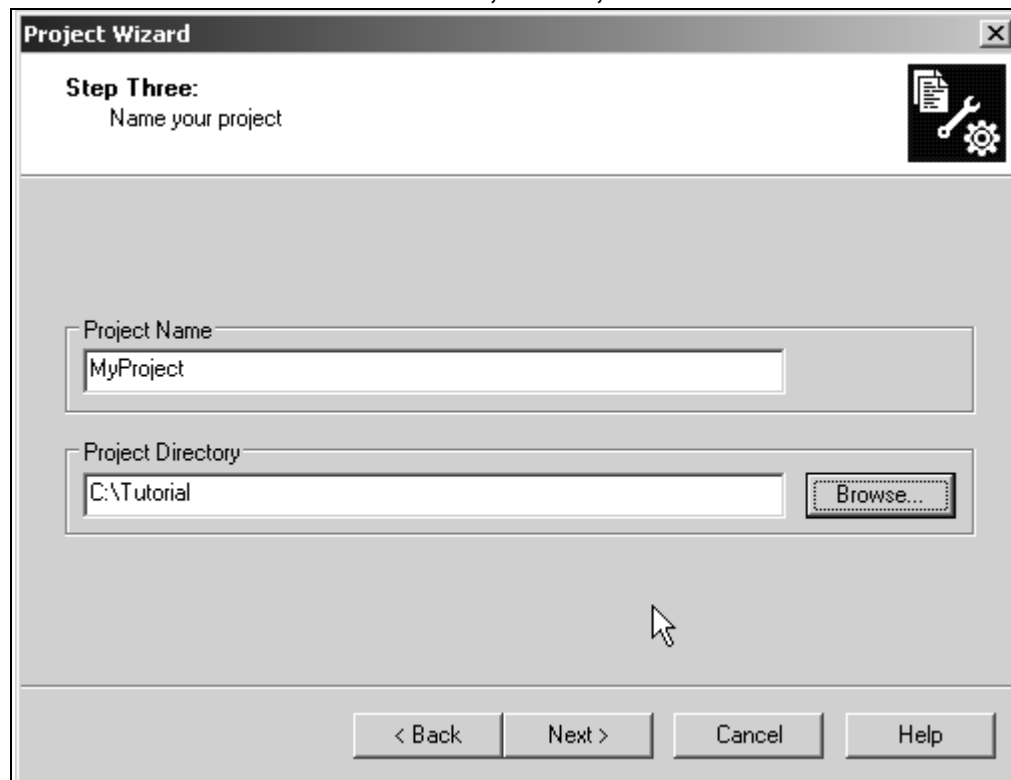

2.4.3 Name Your Project

1. In the **Project Name** text box, type **MyProject**.
2. Click **Browse...** and navigate to `C:\Tutorial` to place your project in the Tutorial folder.
3. Click **Next>** to continue. The Project Wizard Step Four dialog displays (see Figure 2-4).

FIGURE 2-4: PROJECT WIZARD, STEP 4, ADD FILES TO PROJECT

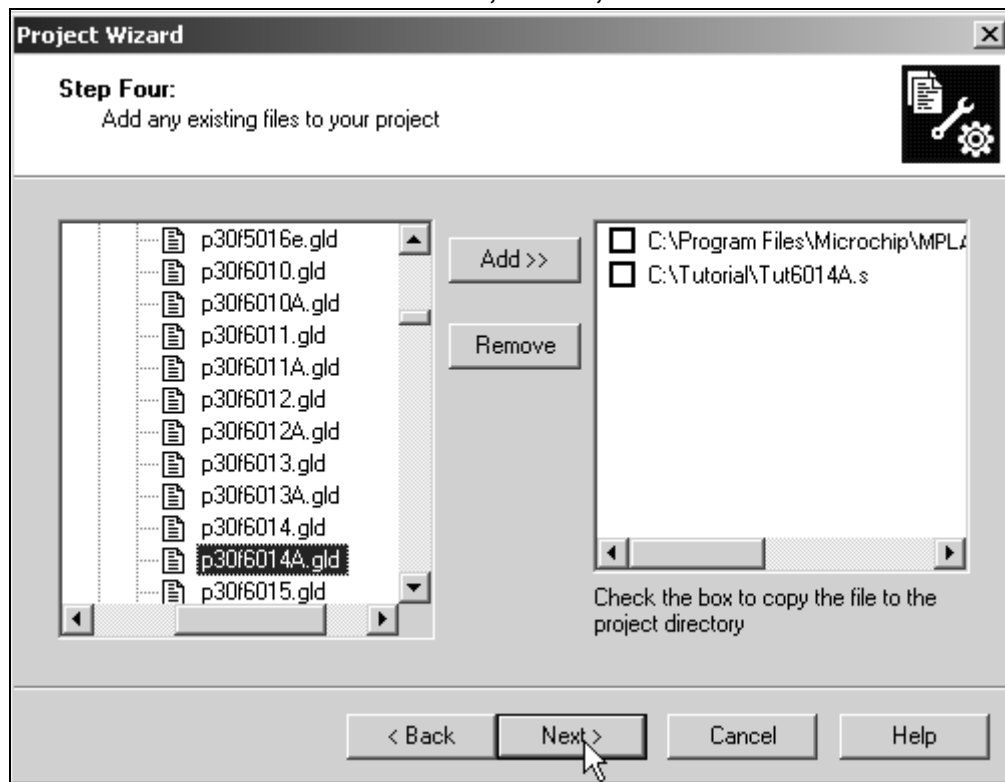

2.4.4 Add Files to Project

1. Locate the C:\Tutorial folder and select the Tut6014A.s file.
2. Click **Add>>** to include the file in the project.
3. Expand the C:\Program Files\Microchip\MPLAB ASM30 Suite\Support\gld folder and select the p30f6014A.gld file.
4. Click **Add>>** to include the file in the project. The project now has two files.
5. Click **Next>** to continue.
6. When the summary screen displays, click **Finish**.

After the project wizard completes, the MPLAB IDE project window shows the Tut6014A.s file in the **Source Files** folder and the p30f6014A.gld file in the **Linker Scripts** folder (see Figure 2-5).

FIGURE 2-5: MPLAB® IDE PROJECT WINDOW

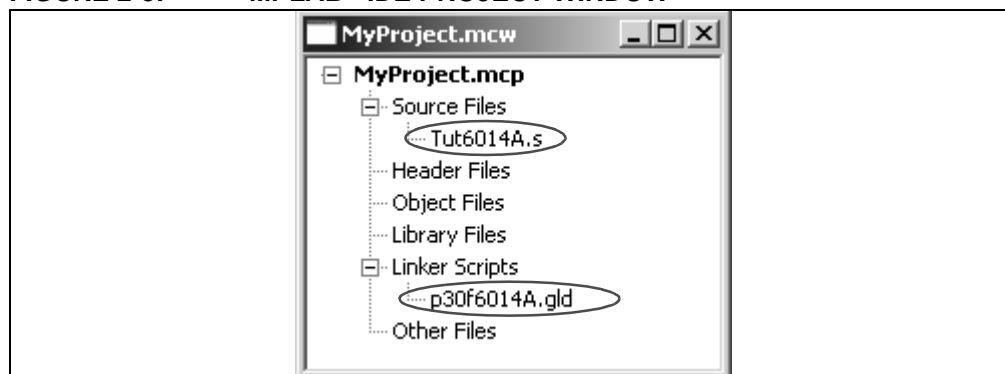

dsPICDEM™ 1.1 Plus Development Board User's Guide

A project and workspace has now been created in MPLAB IDE. MyProject.mcw is the workspace file and MyProject.mcp is the project file. Double click the Tut6014A.s file in the project window to open the file. MPLAB IDE should now look similar to Figure 2-6.

FIGURE 2-6: MPLAB® IDE WORKSPACE WINDOWS

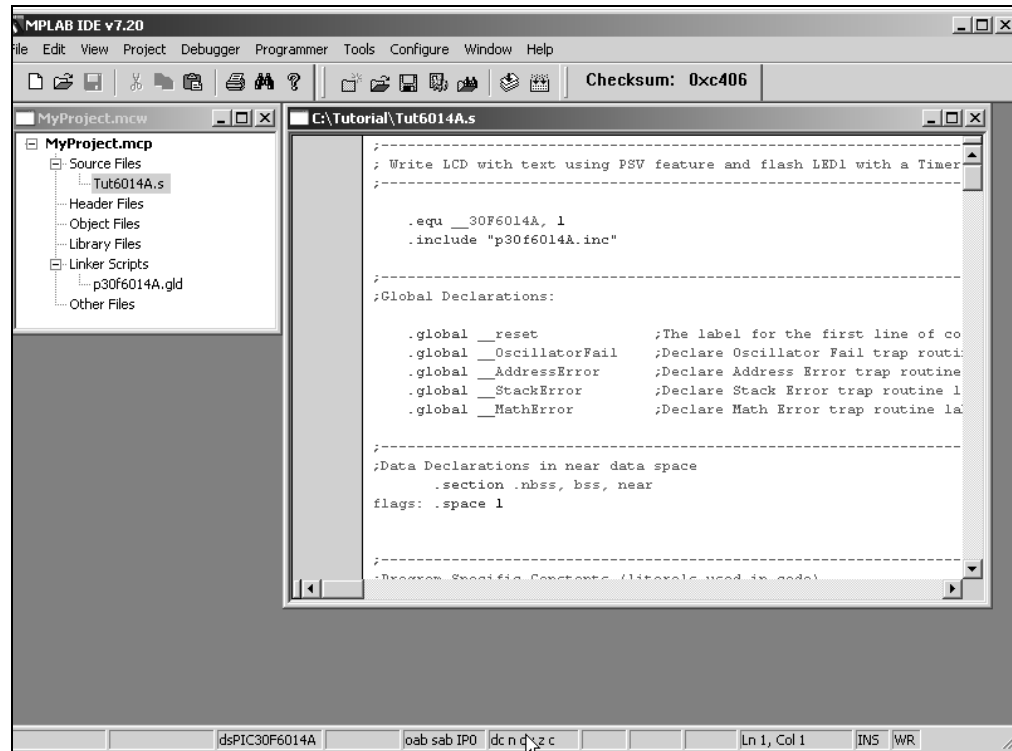

2.5 BUILDING THE CODE

In this project, building the code consists of assembling the `Tut6014A.s` file to create an object file, `Tut6014A.o`, and then linking the object file to create the `Tut6014A.hex` and `Tut6014A.cof` output files. The `.hex` file contains the data necessary to program the device and the `.cof` file contains additional information that lets you debug at the source code level.

Before building, there are settings required to tell MPLAB IDE where to find the include files and to reserve space for the extra debug code when the MPLAB ICD 2 is used.

The following line is near the top of the `Tut6014A.s` file:

```
.include "p30f6014A.inc"
```

This line causes a standard include file to be used. Microchip provides these files with all the Special Function Register (SFR) labels already defined for convenience.

To build the code, select *Build Options>Project* from the *Project>* menu. The Build Options dialog displays, as shown in Figure 2-7.

FIGURE 2-7: BUILD OPTIONS

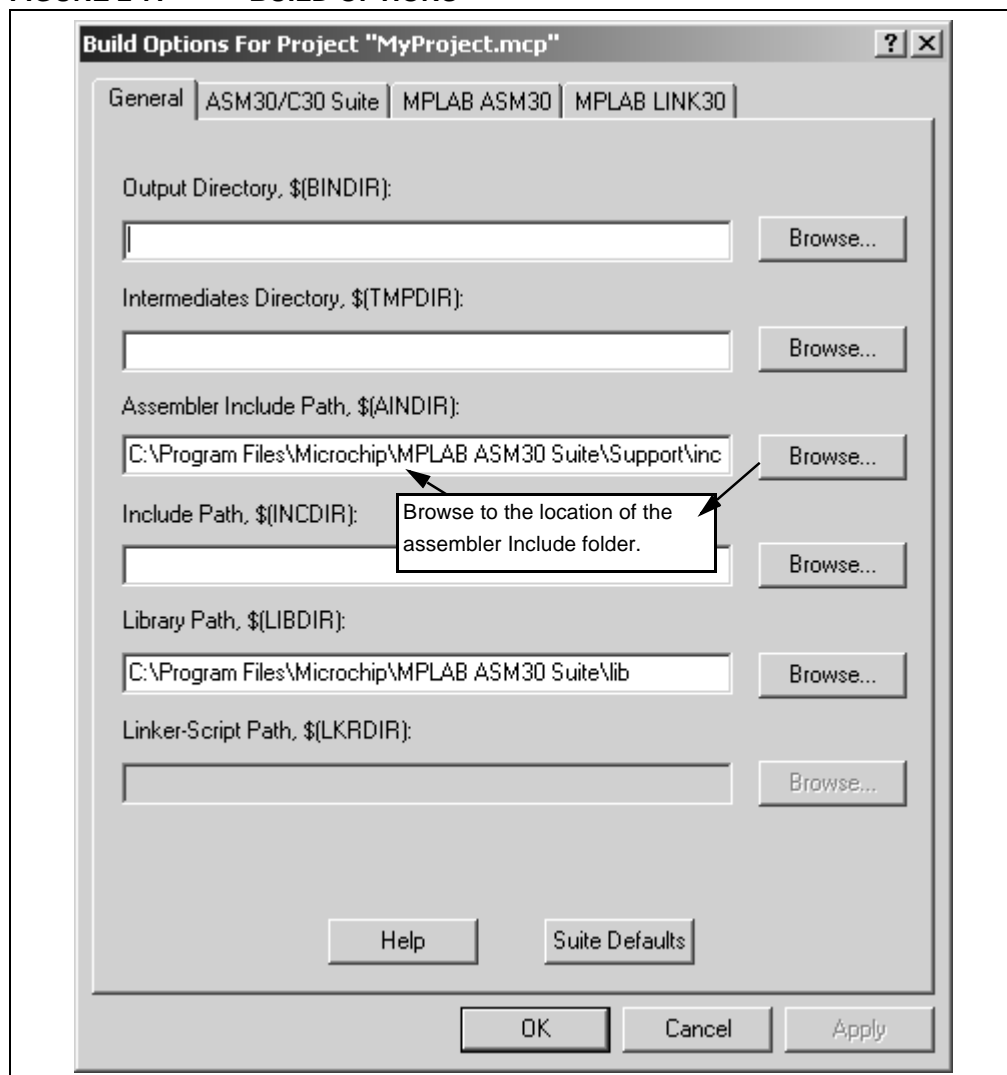

2.5.1 Identify Assembler Include Path

1. Select the General tab.
2. At the **Assembler Include Path, \$(AINDIR)** box, click **Browse...** and navigate to:

C:\Program Files\Microchip\MPLAB ASM30 Suite\Support\Inc

This path tells MPLAB IDE where to find the Include files.

2.5.2 Link for ICD 2

1. Select the MPLAB LINK30 tab to view the linker settings (see Figure 2-8).
2. Check **Link for ICD 2**.
3. Click **Apply**, then click **OK**. The text box closes while the linker reserves space for the debug code used by the MPLAB ICD 2.
4. Click **OK** again to save these changes. The project is now ready to build.

FIGURE 2-8: MPLAB® LINK30 BUILD OPTIONS

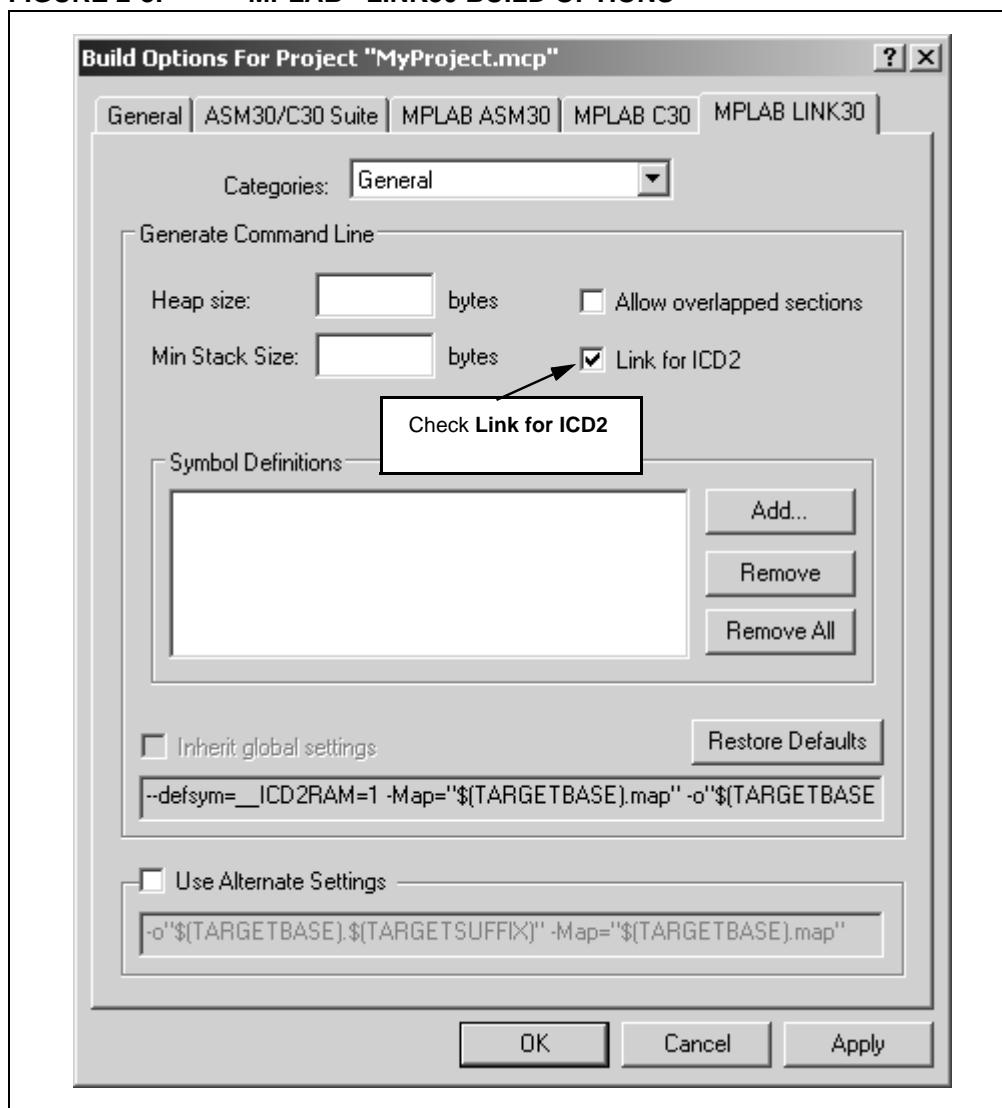

2.5.3 Build the Project

1. Select *Project>Build All*.
2. Observe the progress of the build in the Output window (Figure 2-9).
3. When BUILD SUCCEEDED displays you are ready to program the device.

FIGURE 2-9: BUILD OUTPUT WINDOW

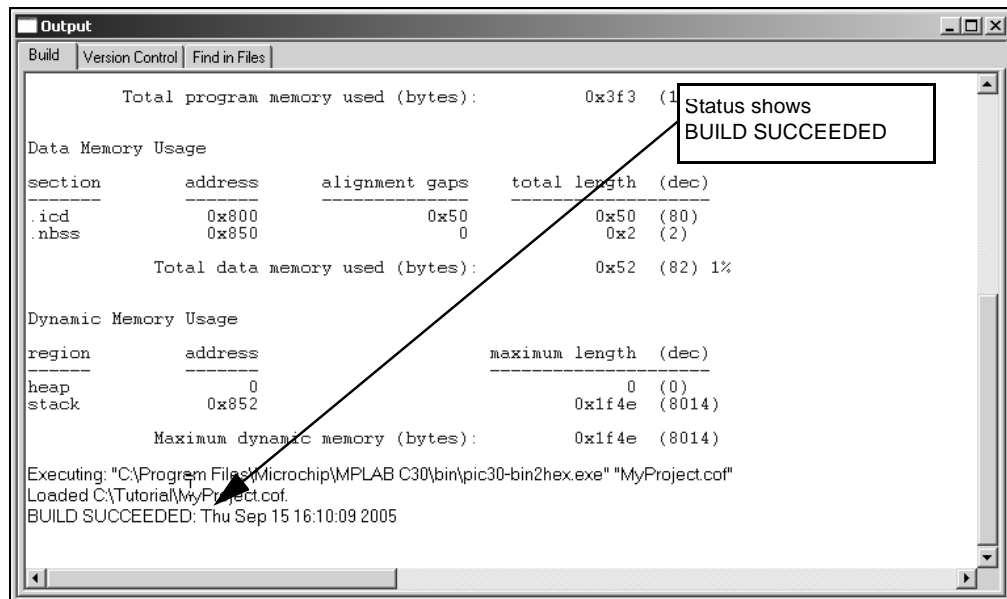

2.6 PROGRAMMING THE CHIP

The MPLAB ICD 2 In-Circuit Debugger can be used to program and debug the dsPIC30F6014A device in-circuit on the dsPICDEM™ 1.1 Plus Development Board.

Note: Before proceeding, make sure that the USB driver for the MPLAB ICD 2 has been installed on your PC (see the “MPLAB® ICD 2 User’s Guide”, DS51331) for more details regarding the installation of MPLAB ICD 2.

Use the following procedures to program the dsPIC30F6014A device.

2.6.1 Set Up the Device Configuration

1. Use the *Configure>Configuration Bits* menu to display the configuration settings.
2. Set up the Configuration bits as shown in Figure 2-10.

FIGURE 2-10: CONFIGURATION SETTINGS

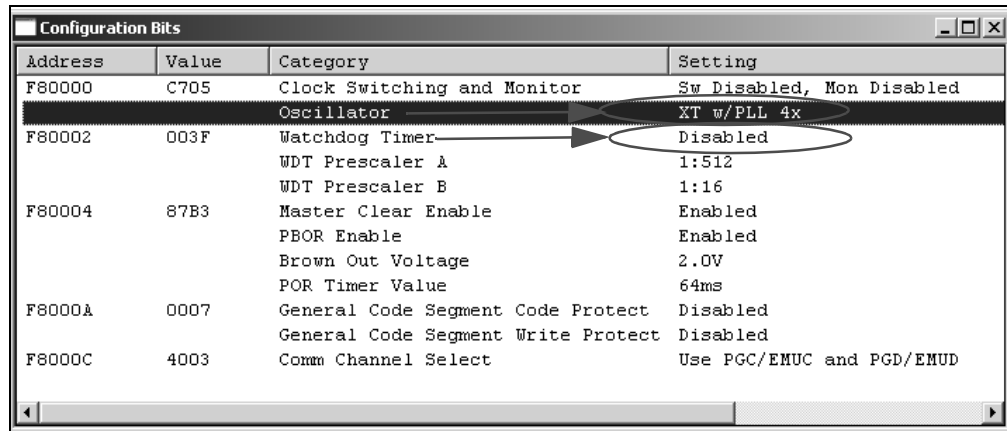

dsPICDEM™ 1.1 Plus Development Board User's Guide

The highlighted configuration settings may need to change to the these values:

Primary Oscillator Mode: XT w/PLL 4x
Watchdog Timer: Disabled

2.6.2 Connect the MPLAB ICD 2 In-Circuit Debugger

1. Before setting up the hardware, check that the following jumpers are in place:
AVDD_JMP: On
J8: 33F PGD3/30F, 33F PGD3/30F
J10: MCLR1
VDD_JMP: On
J21 On (5V)
J22 On (5V)
2. Connect the MPLAB ICD 2 to the PC with the USB cable (see Figure 2-11).
3. Connect the MPLAB ICD 2 to the dsPICDEM™ 1.1 Plus Development Board with the short RJ-11 (telephone) cable.
4. Apply power to the board.

FIGURE 2-11: dsPICDEM™ 1.1 PLUS DEVELOPMENT BOARD CONNECTED TO MPLAB® ICD 2 IN-CIRCUIT DEBUGGER

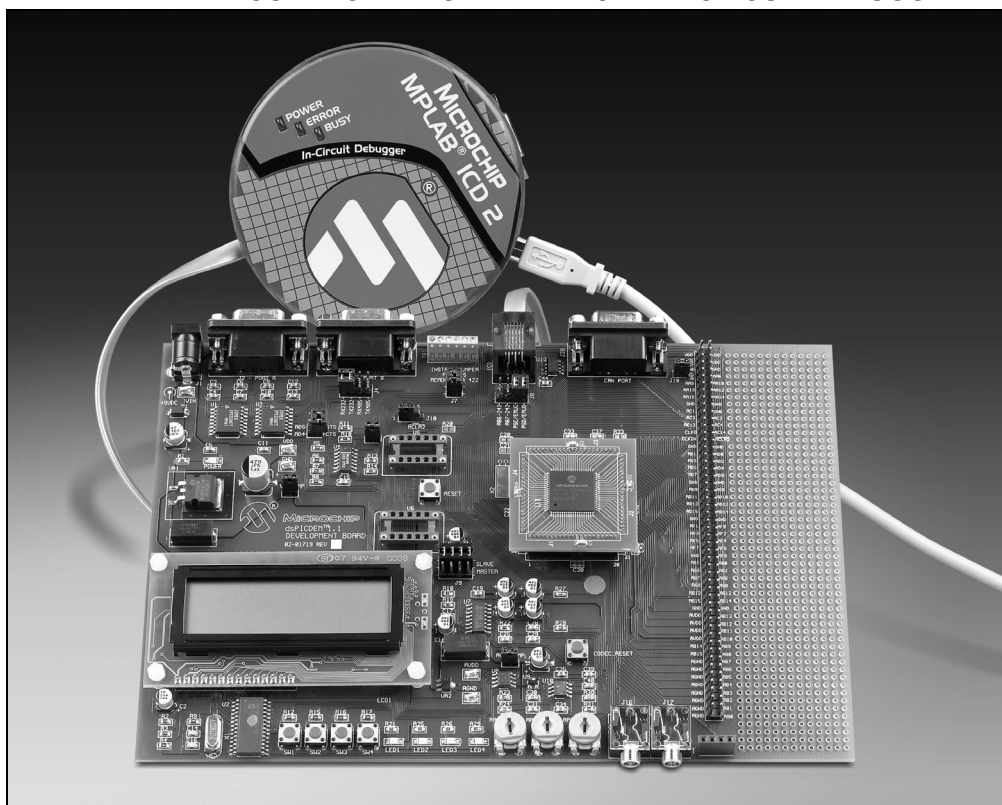

2.6.3 Enable MPLAB ICD 2 Connection

1. From the *Debugger* menu, click *Select Tool>MPLAB ICD 2* to designate the MPLAB ICD 2 as the debug tool in MPLAB IDE.
2. From the *Debugger* menu, select *Connect* to connect the debugger to the device. The MPLAB ICD 2 should report that it found the dsPIC30F6014A device, as shown in Figure 2-12.

Note: MPLAB IDE may need to download new firmware if this is the first time the MPLAB ICD 2 is being used with a dsPIC30F device. Allow it to do so. If any errors are shown, double click the error message to get more information.

FIGURE 2-12: ENABLING MPLAB® ICD 2

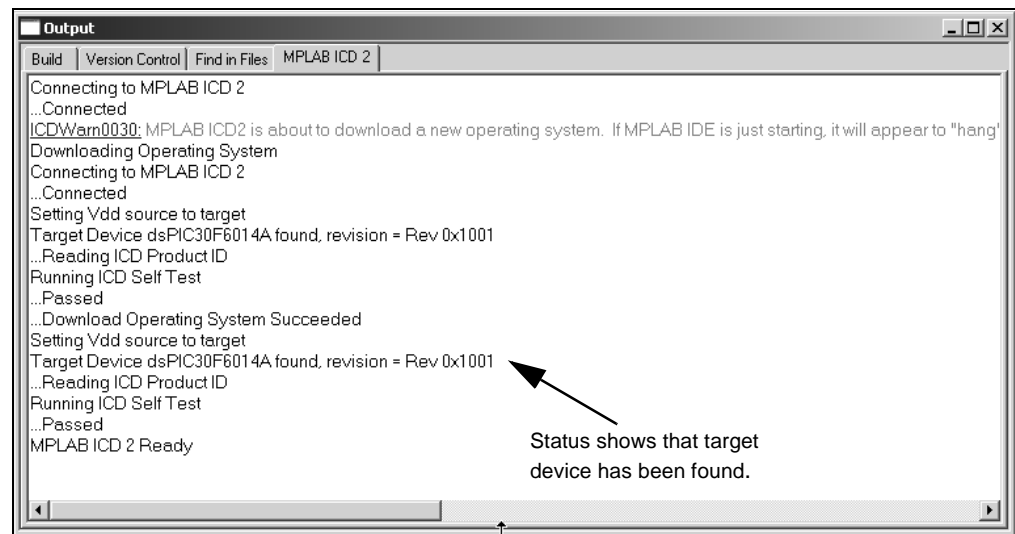

3. From the *Debugger* menu, click *Settings* to display the MPLAB ICD Debugger settings.
4. Select the Program tab.
5. Check **Allow ICD 2 to select memories and ranges**, as shown in Figure 2-13. This setting will speed up operations by programming only a small part of the total program memory.

FIGURE 2-13: SETTING PROGRAM MEMORY SIZE

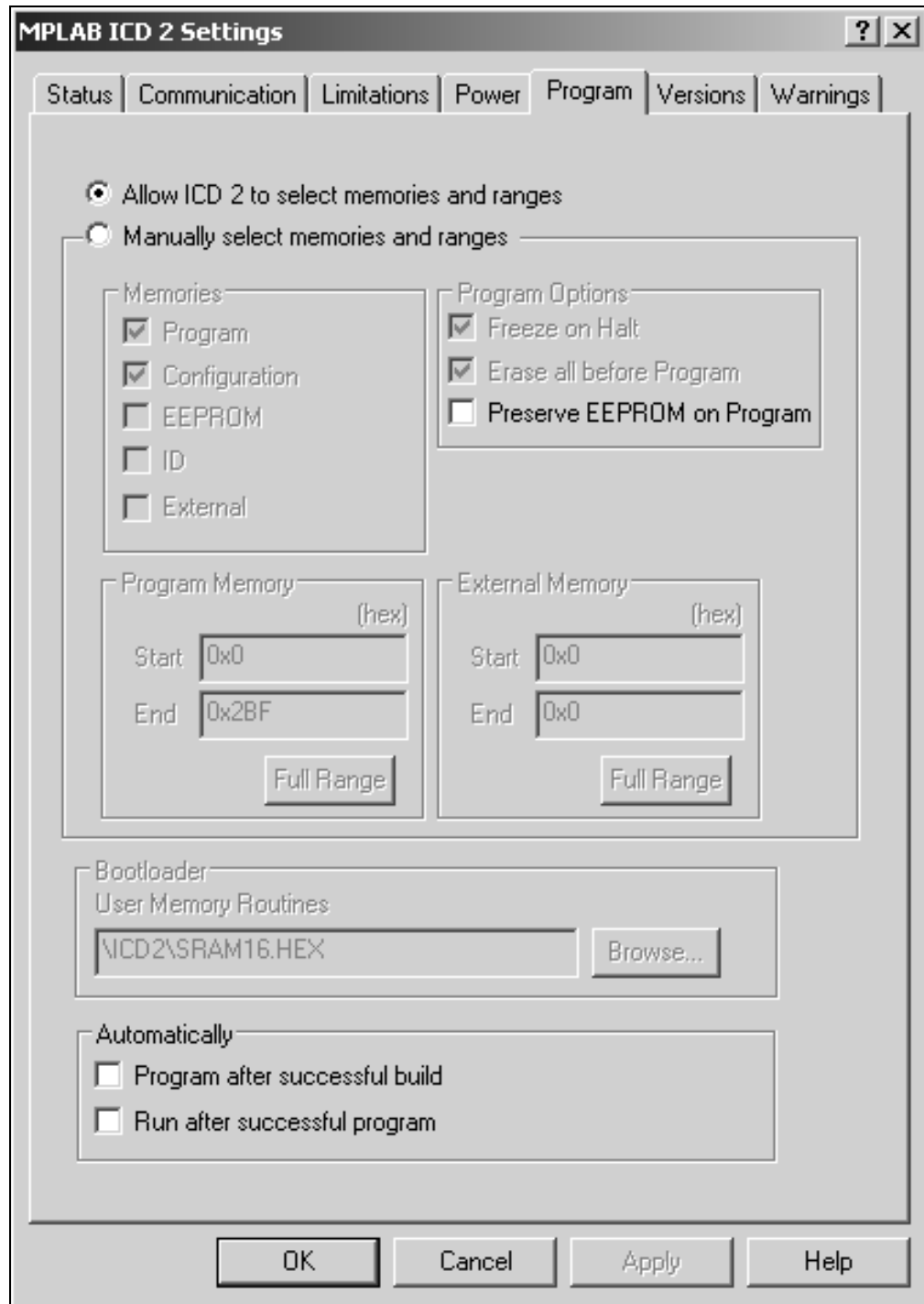

2.6.4 Program the dsPIC30F6014A Device

1. From the *Debugger* menu, select *Program*. The Output window (Figure 2-14) displays the program steps as they occur.
2. Observe the process in the Output window. When “MPLAB ICD 2 Ready” displays, the device is programmed and ready to run.

FIGURE 2-14: PROGRAMMING THE dsPIC30F6014A DEVICE

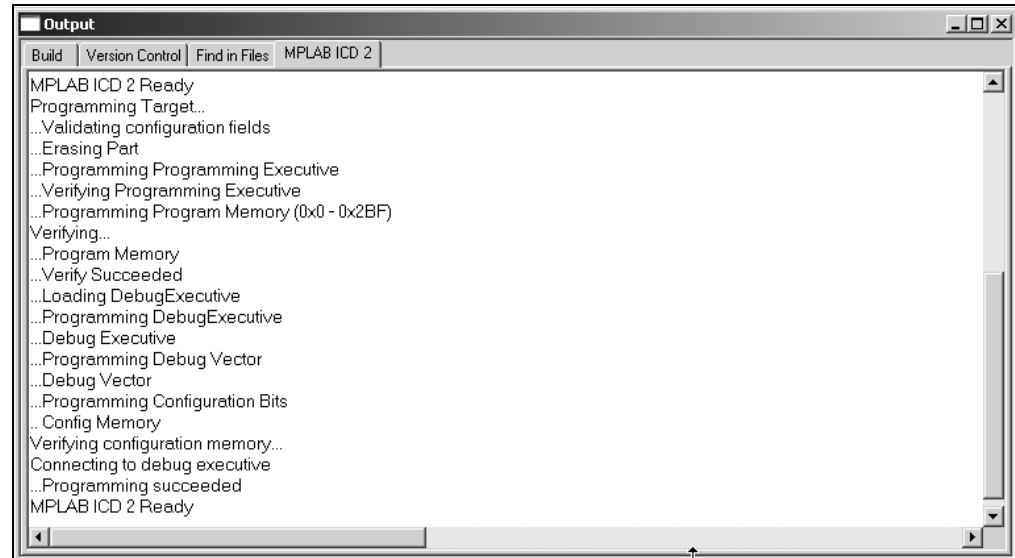

3. Use the *Debugger>Reset* menu to reset the code, then *Debugger>Run* to run the code. LED1 should start blinking and the LCD display should show the text in Figure 2-15.

FIGURE 2-15: TUTORIAL LCD DISPLAY



2.7 DEBUGGING THE CODE

The MPLAB ICD 2 In-Circuit Debugger can be used to run, halt and step the code. A breakpoint can be set to halt the program after the code has executed the instruction at the breakpoint. The contents of the RAM and registers can be viewed whenever the processor has been halted.

The MPLAB ICD 2 In-Circuit Debugger uses the following function keys to access the main debugging functions:

- <F5> Halt
- <F6> Reset
- <F7> Single Step
- <F9> Run

In addition, there are more functions available by right clicking on a line of source code. The most important of these are “Set Breakpoint” and “Run to Cursor”.

2.7.1 Display the Code

1. From the View menu, select Program Memory.
2. On the Program Memory window, select the **Symbolic** tab, as shown in Figure 2-16.

FIGURE 2-16: PROGRAM MEMORY WINDOW

Line	Address	Opcode	Label	Disassembly
1	00000	040100	goto __reset	
2	00002	000000	nop	
3	00004	0002A4	__DefaultInterrupt	
4	00006	0001CA	__OscillatorFail	
5	00008	0001D0	__AddressError	
6	0000A	0001D6	__StackError	
7	0000C	0001DC	__MathError	
8	0000E	0002A4	__DefaultInterrupt	
9	00010	0002A4	__DefaultInterrupt	
10	00012	0002A4	__DefaultInterrupt	
11	00014	0002A4	__DefaultInterrupt	

3. Press <F5> to halt the processor and press <F6> to reset. The program memory now shows a green arrow pointing to the line of code at address 0, the reset location.

The instruction at this location is `goto __reset`. This code is added by the linker to make the program branch to the start of the code in the `Tut6014A.s` file. The code uses the `__reset` label at the start of the executable code and declares the label as `global` to have visibility outside the source file (see Example 2-1).

EXAMPLE 2-1: CODE START-UP

```
.global __reset
.text
__reset:      mov    #__SP_init, W15
              mov    #__SPLIM_init, W0
              mov    W0, SPLIM
```

The linker also provides values for the `__SP_init` and `__SPLIM_init` constants to initialize the stack pointer (`W15`), since the linker determines what RAM is available for the stack.

2.7.2 Step the Program

1. Press <F7> to single step the code. The green arrow now points to the code at `__reset` in the `Tut6014A.s` source code as shown in Figure 2-17.
2. Right click the line of code `mov w0, LATD` and choose *Run to Cursor*. The green arrow then points to the line `mov w0, TRISD`, because it has executed the prior lines of code up to and including `mov #0xFFF0, w0`.

FIGURE 2-17: SOURCE CODE WINDOW

```

C:\Tutorial\Tut6014A.s
-----
;Program Specific Constants (literals used in code)

.equ    Fcy, #7372800

-----
;Start of code

.text                                ;Start of Code section
__reset:  mov  #__SP_init,w15 ;Initialize the Stack Pointer
          mov  #__SPLIM_init,w0
          mov  w0,SPLIM      ;Initialize the Stack Pointer Limit Register
          nop                ;Add NOP to follow SPLIM initialization

-----
;Initialize LED outputs on PORTD bits 0-4

          mov  #0xFFFF,w0 ;Initialize LED pin data to off state
          mov  w0,LATD
          mov  #0xFFF0,w0 ;Set LED pins as outputs
          mov  w0,TRISD
    
```

3. From the *View* menu, select *Watch* to open a Watch window (Figure 2-18).
4. From the **Add SFR** pull-down list, display **TRISD**.
5. Click **Add SFR** to add the TRISD register to the Watch window.
6. Next, select **PORTD** from the pull-down list and click **Add SFR**.
7. Press <F7> a few times and watch the values of TRISD and PORTD SFRs change.

FIGURE 2-18: WATCH WINDOW DISPLAY

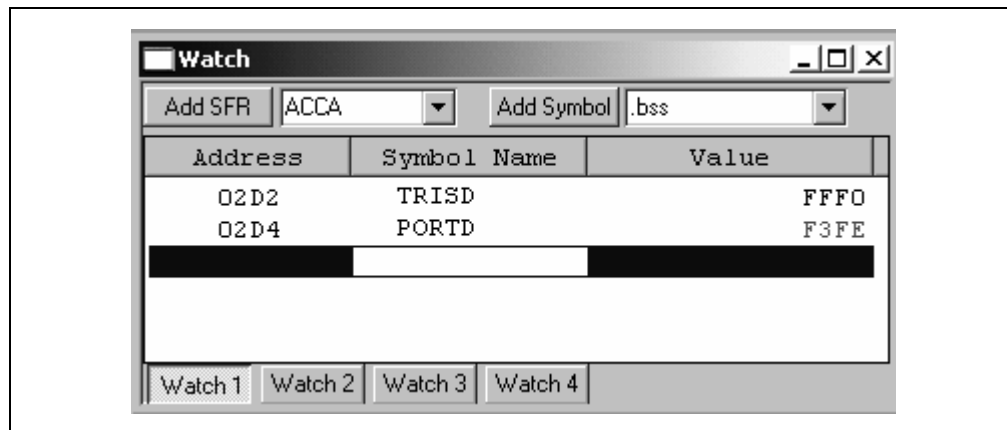

Note: The value displayed for PORTD may be different on your system depending on what load is on PORTD.

2.7.3 Set Breakpoint

1. To set a breakpoint, right click a code line and select Set Breakpoint from the pop-up menu.

Note: An alternate method is to simply double click the line. This feature may need to be enabled using the Edit>Properties menu.

As an example, find the following line of code and set a breakpoint on this line.

```
WrtNextChr: btss flags, #0
```

A red stop sign should appear in the gutter (gray bar on the left) of the source code window.

2. Press <F9> to run the code. The program halts on the instruction following the breakpoint as shown in Figure 2-19.

Note: The instruction on which the code halts could be elsewhere in the code if the breakpoint was set on or immediately after a branch instruction. Refer to Section 12, "Important Notes", in the Readme file for the MPLAB ICD 2.txt file located in the E:\MPLAB IDE\README5 directory for additional operational information.

FIGURE 2-19: SETTING BREAKPOINT

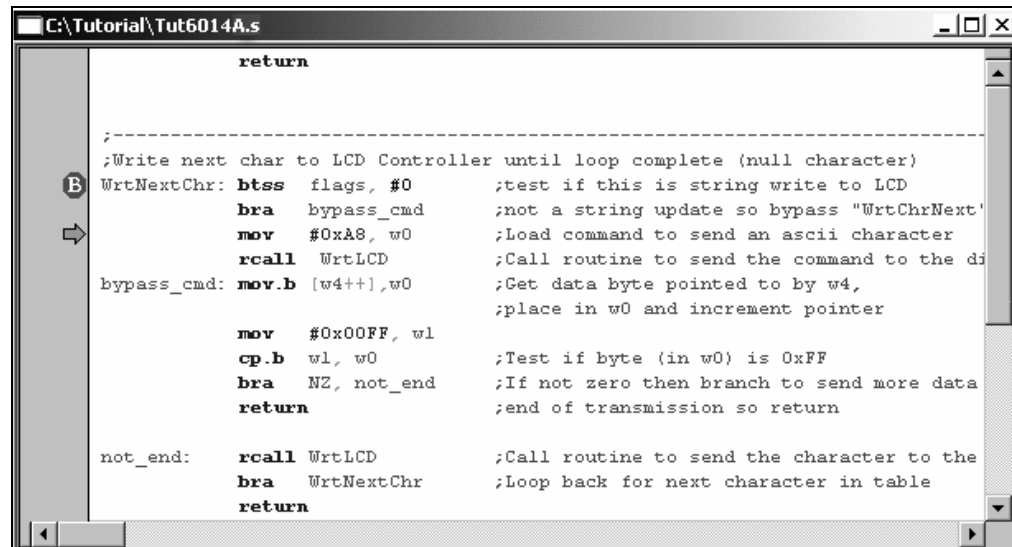

```
return

;-----
;Write next char to LCD Controller until loop complete (null character)
WrtNextChr: btss flags, #0 ;test if this is string write to LCD
             bra bypass_cmd ;not a string update so bypass "WrtChrNext"
             mov #0xA8, w0 ;Load command to send an ascii character
             rcall WrtLCD ;Call routine to send the command to the di
bypass_cmd: mov.b [w4++],w0 ;Get data byte pointed to by w4,
             ;place in w0 and increment pointer

             mov #0x00FF, w1
             cp.b w1, w0 ;Test if byte (in w0) is 0xFF
             bra NZ, not_end ;If not zero then branch to send more data
             return ;end of transmission so return

not_end: rcall WrtLCD ;Call routine to send the character to the
          bra WrtNextChr ;Loop back for next character in table
          return
```

In this example, every time <F9> is pressed to run the code it sends one character to the display and stops at the breakpoint. After the first four spaces, the characters will start to appear on the LCD display.

Chapter 3. dsPIC30F Demonstration Program Operation

3.1 INTRODUCTION

A dsPIC30F DSC device shipped with the dsPICDEM™ 1.1 Plus Development Board includes a pre-programmed demonstration program. This demonstration program exercises several of the dsPIC30F peripherals, such as the 12-bit Analog-to-Digital Converter (ADC) and Codec interface and several of the unique CPU features. This chapter discusses these examples and explains the functionality they demonstrate. For detailed information on the dsPICDEM™ 1.1 Plus Development Board hardware, refer to **Chapter 5. “dsPICDEM™ 1.1 Development Hardware”**.

3.2 HIGHLIGHTS

Items discussed in this chapter are:

- Demonstration Program Operation
- Data and Control Flow
- dsPIC30F Demonstration Performance Metrics
- Board Self-Test Code Module Summary

3.3 DEMONSTRATION PROGRAM OPERATION

The dsPIC30F device included with your dsPICDEM™ 1.1 Plus Development Board is programmed to automatically initiate the demonstration code when power is applied to the board. This code is divided into two separate modules:

- Demonstration code module
- Board self-test code module

This chapter is mostly devoted to describing the demonstration program. The end of the chapter includes a brief summary of the board self-test code module, which has been included on the CD as a library archive only. See **3.6 “Board Self-Test Code Module Summary”**.

3.3.1 Demonstration Code Module Summary

When power is applied to the dsPICDEM™ 1.1 Plus Development Board, the LCD displays the Demo Main Menu, as shown in Figure 3-1.

FIGURE 3-1: POWER-UP DISPLAY

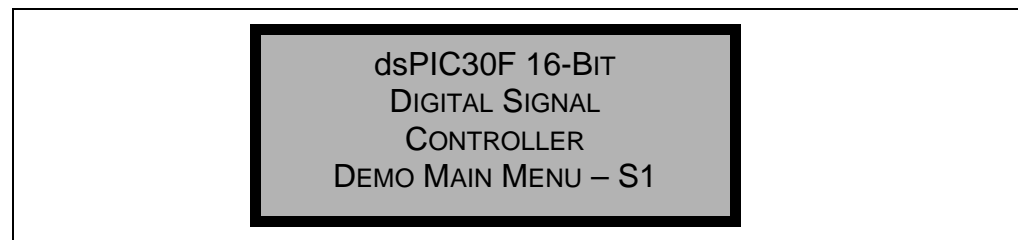

From this menu, pressing switch SW1 displays the menu options for the demonstration program, as shown in Figure 3-2.

FIGURE 3-2: DEMO MENU OPTIONS

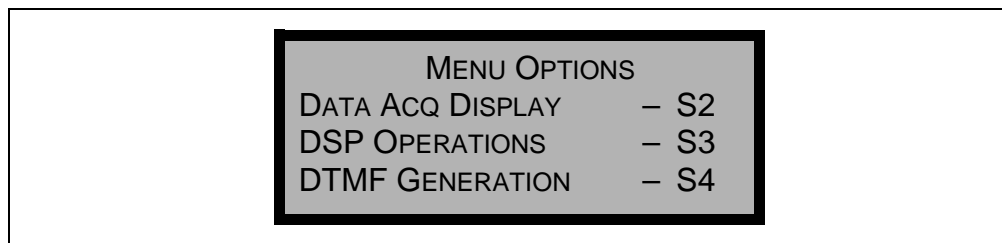

From this menu you can choose one of three demonstration modes:

- Data Acquisition Display mode
- Digital Signal Processing (DSP) Operations mode
- Dual Tone Multi-Frequency (DTMF) Generation mode

3.3.1.1 DATA ACQUISITION DISPLAY MODE

The Data Acquisition Display mode demonstrates the capability of the dsPIC30F device to convert inputs from five different analog signal sources at varying sampling rates.

Data Acquisition mode is initiated by pressing switch SW2. Figure 3-3 shows the resulting display on the LCD.

FIGURE 3-3: DATA ACQUISITION DISPLAY

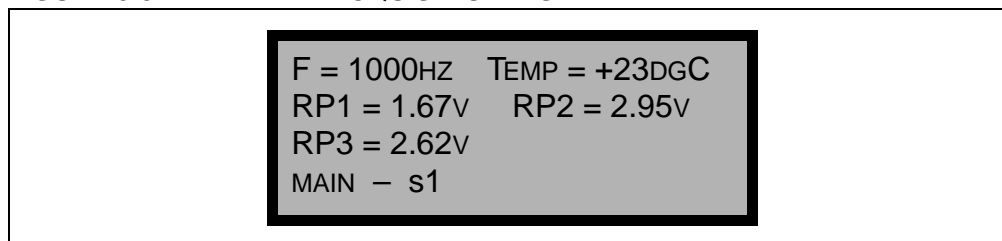

This display shows the values of the following analog signal sources:

- Potentiometers RP1-RP3
The three potentiometers available on the dsPICDEM™ 1.1 Plus Development Board, RP1, RP2 and RP3, are connected to analog input pins AN6, AN4 and AN5, respectively, on the dsPIC30F device.
- Temperature Sensor U9:
Temperature sensor, TC1047A, is connected to the analog input pin, AN8, on the dsPIC30F device.
- Frequency:
A fundamental sine-wave signal is generated by stepping the MCP41010 digital potentiometer (U8) output at an 8 kHz rate. The analyzed frequency is displayed on the LCD.

The 12-bit ADC on the dsPIC30F device is used to convert these analog input sources.

To estimate the frequency of the generated sine-wave signal, the program converts and buffers 256 samples of the signal on pin AN3 and then performs a Fast-Fourier Transform (FFT) on the buffer. The ADC is interrupt driven to sample and convert at a 16 kHz rate for this operation. AN3 is converted on every alternate conversion, thus delivering an effective sampling rate of 8 kHz for the signal presented at AN3.

The program scans input pins AN4, AN5, AN6 and AN8 to sample and convert the values of the temperature sensor and potentiometer signals and delivers one sample of each of these signals to the LCD display.

dsPIC30F Demonstration Program Operation

You can also display the data acquisition values on the communications HyperTerminal on your PC. Use a DB-9 cable to connect “J2 – PORT A” on the development board to the RS-232 serial port on the PC, as shown in Figure 3-4.

FIGURE 3-4: dsPICDEM™ 1.1 PLUS DEVELOPMENT BOARD TO PC CONNECTION

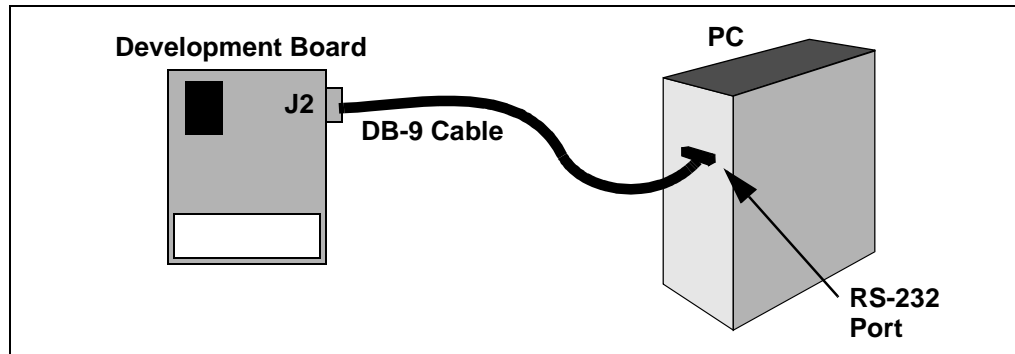

After connecting the cable, configure HyperTerminal for the port settings shown in Figure 3-5. HyperTerminal will show a composite display of the data acquisition values at an update rate of 1.14 seconds.

FIGURE 3-5: HYPERTERMINAL CONFIGURATION SETTINGS

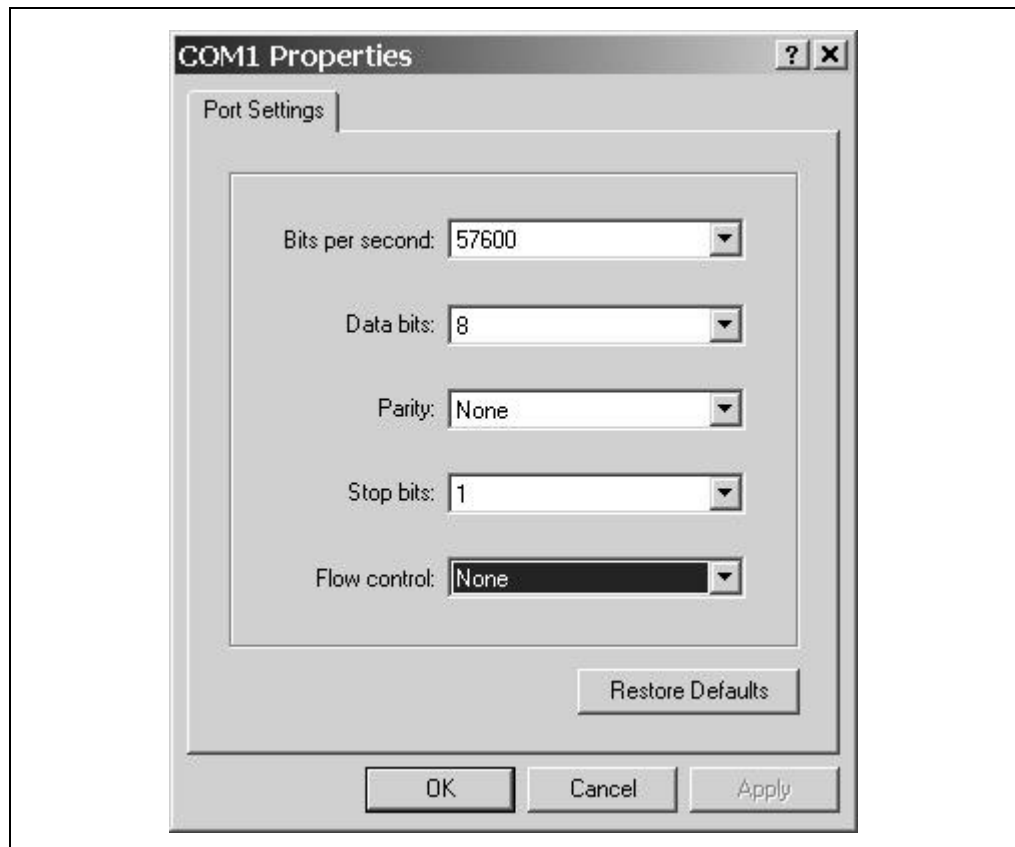

To return to the Menu Options display after running the Data Acquisition demo, press switch SW1.

3.3.1.2 DSP OPERATIONS MODE

From the Menu Options display, pressing switch SW3 launches the DSP Operations demo, which displays the digital signal values shown in Figure 3-6. This display provides information on the various signal processing operations that are performed on the signal at analog input pin, AN3.

FIGURE 3-6: DSP OPERATIONS DISPLAY

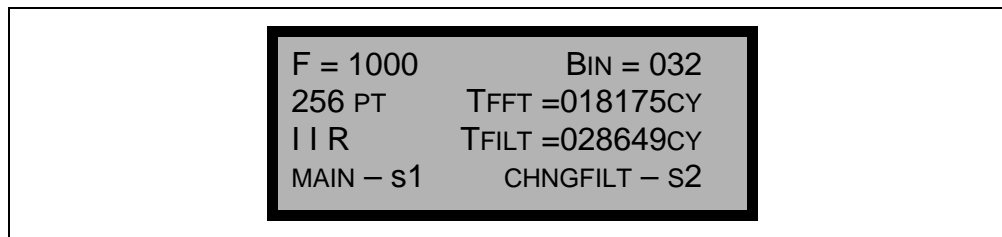

The DSP operations display shows several parameters for a sampled sine-wave signal. A fundamental sine-wave signal is generated by stepping the MCP41010 digital potentiometer (U8) output at an 8 kHz rate. The output of the digital potentiometer is applied to a Low-Pass (LP) filter with a cutoff frequency of approximately 4 kHz. This LP filter removes the high-frequency components and yields a sine wave adequate for this demonstration. Five frequencies are developed and selected by varying potentiometer RP1, as shown in Table 3-1.

TABLE 3-1: FREQUENCIES VS. POTENTIOMETER SETTING

Potentiometer Setting	Resulting Frequency
$0 \leq RP1 \leq 1V$	100 Hz
$1 \leq RP1 \leq 2V$	500 Hz
$2 \leq RP1 \leq 3V$	1000 Hz
$3 \leq RP1 \leq 4V$	1500 Hz
$4 \leq RP1 \leq 5V$	2000 Hz

The filtered output of the MCP41010 is routed to pin AN3/RB3, which is an input to the 12-bit ADC. The ADC collects 256 samples from the MCP41010 at an 8 kHz sample rate. These samples are optionally subjected to a digital filtering algorithm. The following three digital filtering options are provided and selected by switch SW2:

- None
- Infinite Impulse Response (IIR)
- Finite Impulse Response (FIR)

Subsequently, their spectral components are estimated. The frequency estimate of the signal on pin AN3/RB3 is displayed on the first row of the DSP Operations display.

dsPIC30F Demonstration Program Operation

Figure 3-7 depicts the flow of data from the time the analog input is converted by the dsPIC30F device to the time the frequency is estimated.

FIGURE 3-7: DSP OPERATIONS FLOW DIAGRAM

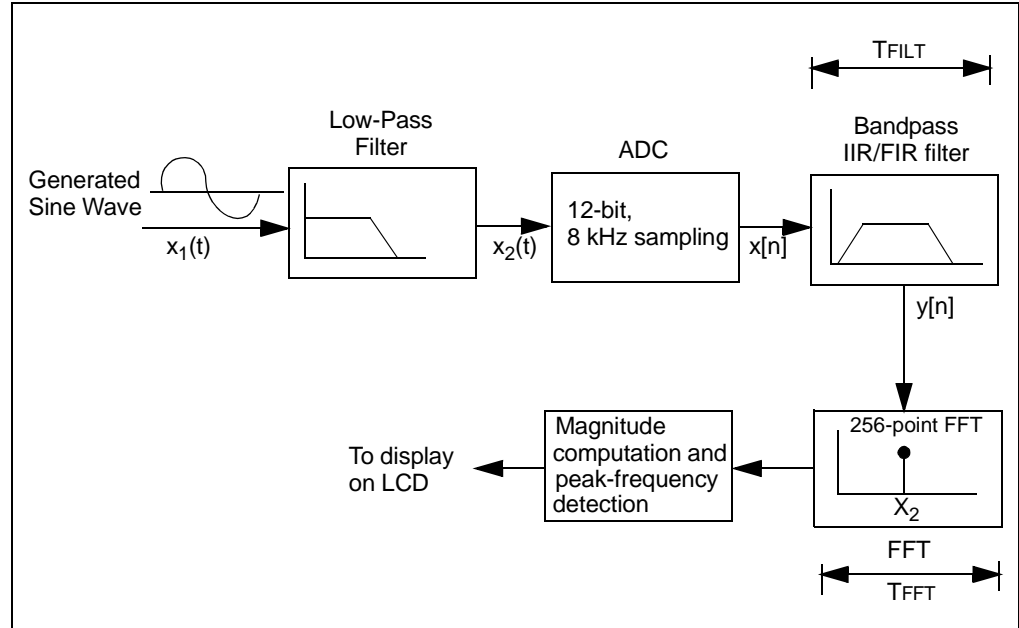

Figure 3-8 shows the frequency response of the IIR filter implementation. The IIR filter is only employed for demonstrating filter operation.

FIGURE 3-8: FREQUENCY RESPONSE: IIR FILTER

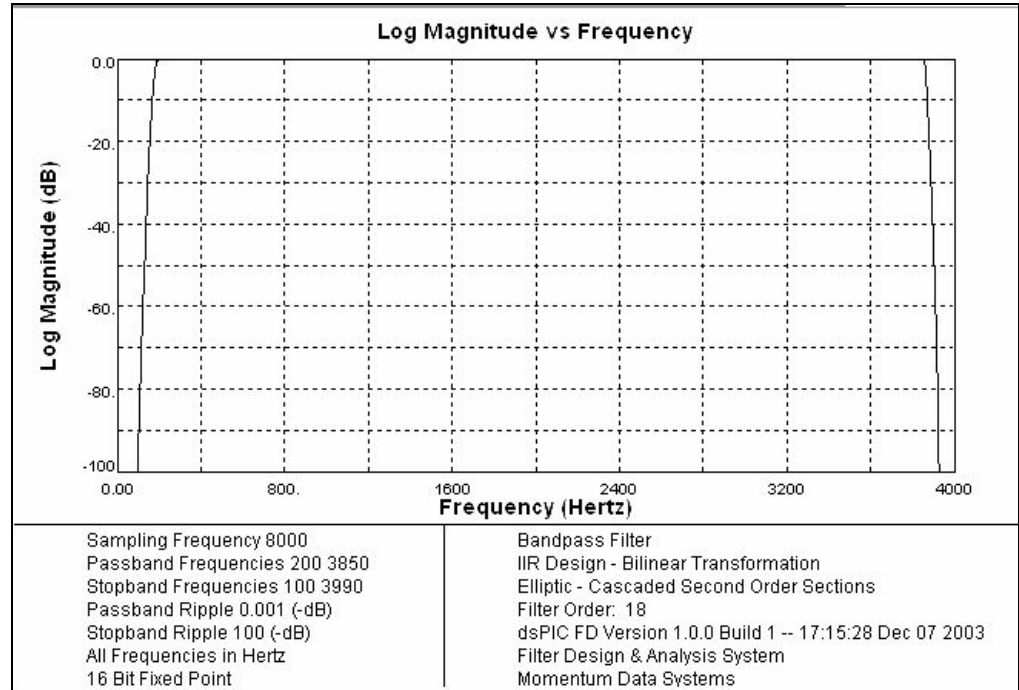
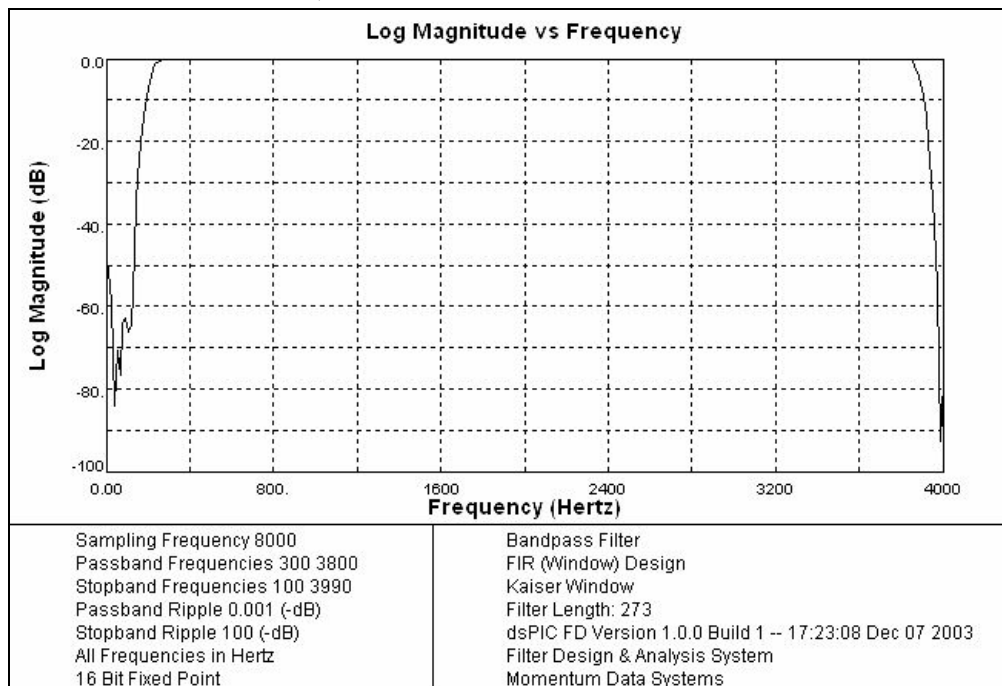

Figure 3-9 shows the frequency response of the FIR filter implemented on the dsPIC30F. The FIR filter is only employed for demonstrating filter operation.

FIGURE 3-9: FREQUENCY RESPONSE: FIR FILTER



The signal frequency determined by analyzing the 256-point FFT and associated bin is displayed on the LCD. Cycle counts for the digital filters and FFT are displayed on the LCD.

To quit this demonstration and return to the main menu, press switch SW1.

3.3.1.3 DTMF GENERATION MODE

From the Menu Options display, pressing switch SW4 launches the DTMF Generation demo and takes you to the DTMF operation menu (Figure 3-10).

FIGURE 3-10: DTMF TONE GENERATION MENU

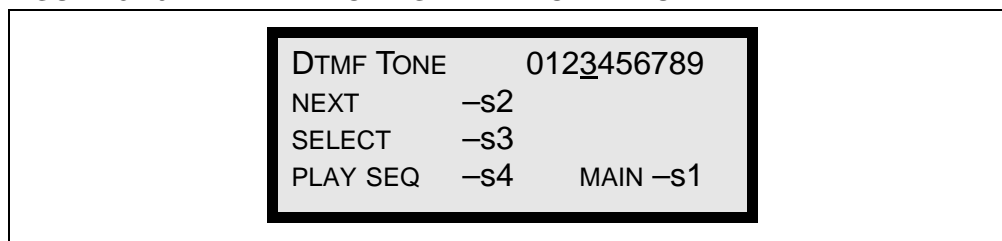

When this display is active, switches SW2-SW4 control tone generation, as shown in Table 3-2.

TABLE 3-2: DTMF TONE GENERATION CONTROLS

Switch	Function
SW2	Moves blinking cursor to the next DTMF Tone digit
SW3	Plays the DTMF tone associated with the digit selected by s2
SW4	Plays a predetermined sequence of ten DTMF tones

dsPIC30F Demonstration Program Operation

Each DTMF tone consists of two sinusoids: a high-frequency component and a low-frequency component. In the DTMF tones implemented for this demonstration, the high-frequency component is at a level 8 dB lower than the low-frequency component. You can listen to the generated tones by using either a headset or a passive speaker connected to the “SPKR OUT” jack (J17).

Note: For a passive speaker, use a Radio Shack Model # 40-1434 Fold-up Stereo Speaker System or an equivalent device.

If you connected your PC for the Data Acquisition Display demo (see Section 3.3.1.1), you can use the <0>-<9> keys on the PC keyboard to select a DTMF tone.

To quit this demonstration and return to Menu Options, press switch SW1.

3.3.2 Demonstrated Features and Peripherals

The following two sections summarize the key dsPIC30F MCU, DSP and peripheral features implemented in this general purpose demonstration program.

3.3.2.1 dsPIC30F MCU/DSP FEATURES

The demonstration program uses several unique dsPIC30F MCU/DSP features for various processing functions, including:

- DSP Engine for FFT, FIR and IIR computations
 - 40-bit accumulators with Saturation, Overflow and Rounding modes
 - Multiply-and-Accumulate (MAC) class of DSP instructions
- Bit-Reversed Addressing for 256-point FFT input data in preparation for the FFT “butterfly” computations
- Modulo Addressing for accessing arrays in a circular fashion for FIR filtering
 - Two modulo buffers have been implemented, one each in X and Y data spaces.
- Hardware Loop instructions
 - DO and REPEAT instructions provide minimal overhead when executing a block of instructions repetitively.
- Program Space Visibility (PSV)
 - Large tables for FIR filter coefficients, sine tables etc., are stored in and accessed from program memory.

3.3.2.2 dsPIC30F DEMO PERIPHERALS

The demonstration program also implements several dsPIC30F peripherals for various tasks. These peripherals include:

- Timer1 – Configured as a 16-bit timer
- Timer2 – Configured as 16-bit timer with a 256:1 prescaler
- Timer3 – Configured as 16-bit timer with a 256:1 prescaler
- Timer4 and Timer5 – Configured as a 32-bit timer
- UART2 TX/RX – Used to transmit demo data to the PC and receive commands from the PC keyboard
- SPI 2 – Used to communicate to the 122 x 32 Addressable-Pixel LCD via the PIC18F242 LCD controller and MCP41010 digital potentiometer
- 12-bit ADC – Used to convert multiple analog signals, including temperature and sine-wave signals generated by the MCP41010 digital potentiometer through a low-pass filter

dsPICDEM™ 1.1 Plus Development Board User's Guide

- Data Converter Interface – Interfaced to an external Si3000 voice band Codec for transmission of DTMF PCM signals
- INTx pins – Used for detecting switch SW1-SW4 inputs
- Hierarchical/Prioritized Interrupt Control with nesting enabled

3.4 DATA AND CONTROL FLOW

3.4.1 Power-up Sequence

The power-up peripheral initialization sequence is shown in Table 3-3.

TABLE 3-3: POWER-UP PERIPHERAL INITIALIZATION SEQUENCE

Seq	Module or Function	Initialization Process
1	Timer1	Configured to count to 125 μ S, but not enabled.
2	Timer2	Configured to count to 1 second using a 256:1 prescaler setting.
3	Timer3	Configured to count up to 1.14 seconds using the 256:1 prescaler setting.
4	Timer4 and Timer5	Configured to operate in the 32-bit Timer mode, but not enabled until needed.
5	Interrupt Service Routine (ISR)	Processing is enabled for Timer2 and Timer3.
6	UART2	Both the transmitter and receiver are configured for interrupt-driven operation at 57600 baud.
7	SPI 2	Initially configured to operate in an interrupt-driven mode at $F_{CY}/8$ Hz (where $F_{CY} = 7.3728$ MHz). The module communicates at $F_{CY}/8$ Hz in 8-bit mode while displaying results on the LCD controller. When it is used to step the MCP41010, it operates in the 16-bit mode at $F_{CY}/32$ Hz.
8	Data Converter Interface (DCI)	Configured for Master mode. Initially configured to use two of four buffers. Transmits/receives in time slot 1 at the frame rate of 7200 Hz for configuring the Si3000 external voice band Codec.
9	Si3000	Configured for Slave mode. The Si3000 line and speaker ports are enabled. Signal attenuation is set to 0 dB. The ADC input from the Si3000 is attenuated by 34.5 dB and is not used in this demo.
10	DCI	Re-initialized to operate with all four buffers in interrupt-driven mode for transmitting DTMF PCM words to the Si3000 Codec.
11	External interrupt pins INT1-INT4	Configured to interrupt on the falling edge and used for switches SW1-SW4, respectively.
12	12-bit ADC	Configured to operate at 16000 Hz sampling rate and generate an interrupt every 16 sample-convert sequences. The ADC samples channel AN3 (sine wave), AN4 (RP2), AN5 (RP3), AN6 (RP1) and AN8 (temperature sensor U9).
13	Interrupts	Peripheral interrupts are configured. Nested interrupts are enabled.

dsPIC30F Demonstration Program Operation

3.4.2 Main Loop Code Execution

The step-by-step Main Loop execution sequence is shown in Table 3-4.

TABLE 3-4: MAIN LOOP CODE EXECUTION SEQUENCE

Seq	Program Task
1	12-bit ADC collects 256 samples from the digital potentiometer output on AN3 into a RAM buffer. It also collects one sample each from AN4 (RP2), AN5 (RP3), AN6 (RP1) and AN8 (Temperature Sensor U9). All A/D conversions are performed in an interrupt-driven configuration.
2	Buffered data set is filtered using an IIR filter to remove line noise. The filter can be changed to an FIR filter or no filter from the DSP menu options. The filtering operation is benchmarked using the Timer4/5 pair.
3	A complex in-place 256-point FFT is performed on the filtered data set, resulting in complex frequency data ($x + jy$). This operation is benchmarked using the Timer4/5 pair.
4	Squared magnitude is computed for each frequency bin in an in-place fashion ($x^2 + y^2$).
5	The magnitude data is run through a routine that returns the frequency bin and magnitude of the largest element.
6	The magnitude of the largest element is compared against a threshold and captured if it is greater than the threshold so that low-level noise does not show up as a frequency estimate. (Provides a simplified peak-detection algorithm.)
7	If a Timer3 count has expired, a software flag is set to inform the CPU that the results recorded may now be displayed. This ensures that the CPU refreshes the display buffers.
8	Any user choices entered via the switches SW1-SW4 are checked and the new user selections are applied. May involve a change of display screen or some parameter displayed on the LCD.
9	The changes are communicated to the PIC18F242 LCD controller via the SPI 2 module.
10	In the special case of the DTMF menu, the main routine may also kick off the DCI module operation when the user requests DTMF tone generation.

3.4.3 Interrupts Used in the Demo

3.4.3.1 EXTERNAL INTERRUPTS TO MAIN ROUTINE

External interrupts INT1-INT4 are controlled by switches SW1-SW4.

These switches provide selection capabilities for the demo program. The most recent switch presses are recorded in a variable within the interrupt routines. In the main routine, the variable is analyzed to determine what action is requested by the recent switch event.

3.4.3.2 DCI INTERRUPTS AND DTMF

The DCI module interrupts the CPU when all four TXBUF registers have been transmitted. The DCI is used to send out DTMF tones to the Codec. The tonal components are stored as sinusoid tables in program memory and accessed using Program Space Visibility (PSV).

The DCI ISR keeps track of the number of samples sent. The DTMF tones are transmitted by adhering to International Telecommunication Union (ITU-T) specifications. For example, the ON time for tones is greater than 40 mS and the OFF time is less than 23 mS. The actual values are 100 mS of ON time and 15 mS of OFF time. When playing a pre-recorded sequence of tones, a PAUSE time is added between successive tones. This time is equal to the ON time of the tone. Also, the high and low frequency of the DTMF tone are separated by 8 dB. The high frequencies are reduced in magnitude relative to the low frequencies by 8 dB.

3.4.3.3 UART RECEIVE INTERRUPTS

Single DTMF tones may also be played by entering numeric characters (0-9) on the PC keyboard during the HyperTerminal session. The UART receives this keyboard character, and a receiver interrupt communicates this data to the DCI to start a tone generation process.

3.4.3.4 UART TRANSMIT INTERRUPTS

Every 1.14 seconds, data is transmitted via the UART to the HyperTerminal session window. Four bytes are loaded at a time in the Transmitter Buffer registers. The term "data" refers to the following:

- Analog data such as RP1, RP2 and RP3
- Temperature sensor data
- FFT frequency and bin number of the sampled input sine-wave signal
- Cycle count information for the FFT, FIR or IIR algorithms
- Chosen Filter Type – IIR, FIR or None

3.4.3.5 SPI INTERRUPTS, DIGITAL POT AND THE LCD CONTROLLER

The SPI 2 module is used to perform two functions:

- When the demo code is waiting for the ADC to collect 256 samples of data on pin AN3, the SPI 2 module is used by the Timer1 ISR to transmit sine-wave samples to the MCP41010 every 125 microseconds at a data rate of 230 kHz.
- When code execution reaches the DSP stage (i.e., filtering, FFT etc.) the SPI 2 module is used to send data to the PIC18F242 LCD controller on the expansion board at a data rate of 921.6 KHz ($F_{CY}/8$). The LCD has a 4 row x 20-character display. All 80 characters are refreshed by the SPI 2 module.

dsPIC30F Demonstration Program Operation

3.4.3.6 TIMER1

Timer1 is a 16-bit timer that uses the instruction cycle as its time base. It is configured to time out and generate an interrupt every 125 microseconds. The Timer1 Interrupt Service Routine (ISR) loads the SPI 2 buffer with a value from a sine table. The SPI 2 module is then used to transmit the sine sample to digital potentiometer MCP41010. The MCP41010 output is connected to pin AN3/RB3 of the dsPIC30F device.

3.4.3.7 TIMER2

LEDs 1-4 count upward in binary form from 0 through 15. The count rate is controlled by the 16-bit Timer2 module, which expires every second as it is operated in a 256:1 prescale mode, with the instruction cycle being the count interval.

3.4.3.8 TIMER3

The Timer3 count is configured to expire every 1.14 seconds. In the Timer3 ISR, a software flag is used to determine whether data needs to be updated to the PC via the UART2 module. Thus data is not transmitted to the PC all the time so that the data on the HyperTerminal window is legible. Data sent to the LCD, however, is refreshed continuously since it does not have a “scrolling” effect.

3.5 dsPIC30F DEMONSTRATION PERFORMANCE METRICS

The dsPIC30F performance metrics are primarily based upon acquisition and processing of the 256 discrete samples. The discrete samples are acquired by the ADC sampling of a sine-wave signal applied to analog channel input AN3.

The sine-wave signal is generated as a result of stepping the MCP41010 digital potentiometer at an 8 kHz rate with its output applied to a low-pass filter with a cutoff frequency of approximately 4 kHz.

This acquisition and processing sequence repeats in a continuous loop.

Upon user command via the LCD menu system (or optionally from PC keys <0>-<9>), DTMF tones are generated. During this time additional CPU MIPS are required.

This demonstration was developed for the development board that is supplied with a 7.3728 MHz crystal. The dsPIC30F is programmed for the XTx4PLL mode of operation, effectively yielding 7.3728 MIPS. Additional MIPS are not required for this demo but could have been obtained by using the XTx8PLL and XTx16PLL modes of operation yielding 14.7456 and 29.4912 MIPS.

<p>Note: The demo code as supplied has specific timing parameters derived from the 7.3728 MHz crystal with the XTx4PLL mode. Changing the device time base will require modification of several time-specific parameters.</p>
--

dsPICDEM™ 1.1 Plus Development Board User's Guide

Following is a summary of the processing time for each of the main demo functions. The data is based upon a 256 sample size.

- Acquisition of 256 discrete sine-wave data points sampled at 8 kHz
 - Total acquisition time = 32 mS (256/8000)
- FIR filtering – 72,734 instruction cycles for block processing 256 samples in a 273-tap band-pass filter
 - 9.87 mS @ 7.3728 MIPS
- IIR filtering – 28,649 instruction cycles for block processing 256 samples in a 9-section bi-quad bandpass filter
 - 3.89 mS @ 7.3728 MIPS
- 256-point complex FFT – 18,176 instruction cycles
 - 2.47 mS @ 7.3728 MIPS

Note: Filtering and FFT operations may be interrupted by the DCI, Timer2 or UART2 modules. The time metrics presented above account for the interrupt handler processing time from these interrupts.

- The interrupt-driven UART2 transmitter is triggered every 1.14 seconds by Timer3 to send out approximately 145 characters.
 - At 57600 baud, transmission of 145 characters requires approximately 25 mS
- SPI 2 transmits 160 characters (80 control and 80 data) @ Fcy/8 Hz (where Fcy = 7.3728 MHz) to the PIC18F242 LCD controller for LCD screen updates.

3.5.1 Performance Metric Summary with FIR Filter

The overall CPU performance metric is calculated on how many complete processing cycles can be performed over a 1 second interval. In one second, the dsPIC30F spends the following amounts of time in each of the three major functions:

- FFT Computation:
 - 22.55 x 256-point complex FFTs = 55.69 mS
- FIR Filter Computation:
 - 22.55 x 273-tap FIR filters = 223 mS
 - Coefficients stored in program memory
- CPU Idle:
 - Waiting for ADC data = 721 mS

The 22.55 multiplier used in the above computations is based upon how many times in one second 256 samples can be acquired and then processed by the FIR and FFT algorithms.

For example:

- 32 mS for acquisition of 256 samples
- 9.87 mS for FIR filtering
- 2.47 mS for 256-point FFT

Adding these three major timing metrics results in 44.34 mS. Therefore, this 44.34 mS cycle is repeated 22.55 times in a 1 second interval.

Total MIPS required = 2.1 MIPS out of available 7.3728 MIPS.

FIR filter specifications are listed in Table 3-5.

dsPIC30F Demonstration Program Operation

TABLE 3-5: FIR FILTER SPECIFICATIONS

Specification	Value
FIR filter type	BandPass Kaiser Window – 273 coefficients
Passband ripple	0.001 dB
Stopband ripple	100 dB
Passband cutoff frequencies	300 Hz and 3800 Hz
Stopband cutoff frequencies	100 Hz and 3990 Hz
Sampling frequency	8000 Hz

The filter coefficients and code were generated by the Digital Filter Design Tool.

3.5.2 Performance Metric Summary with IIR Filter

The following overall CPU performance metric is calculated on how many complete processing cycles can be performed over a 1 second interval.

- FFT Computation:
 - 26 x 256-point complex FFTs = 64.2 mS
- IIR Filter Computation:
 - 26 x 9 second order elliptic section IIR filters = 101 mS
Coefficients stored in program memory
- CPU Idle:
 - Waiting for ADC data = 834 mS

The 26 multiplier used in the above computations is based upon how many times in one second 256 samples can be acquired and then processed by the IIR and FFT algorithms.

For example:

- 32 mS for acquisition of 256 samples
- 3.89 mS for IIR filtering
- 2.47 mS for 256-point FFT

Adding these three major timing metrics results in 38.3 mS. Therefore, this 38.3 mS cycle is repeated approximately 26 times in a 1 second interval.

Total MIPS required = 1.22 MIPS out of available 7.3728 MIPS.

IIR filter specifications are listed in Table 3-6.

TABLE 3-6: IIR FILTER SPECIFICATIONS

Specification	Value
IIR filter type	Bandpass, Elliptic, 9 Second Order Sections
Passband ripple	0.001 dB
Stopband ripple	100 dB
Passband cutoff frequencies	200 Hz and 3850 Hz
Stopband cutoff frequencies	100 Hz and 3990 Hz
Sampling frequency	8000 Hz

The filter coefficients and code were generated by the Digital Filter Design Tool.

3.6 BOARD SELF-TEST CODE MODULE SUMMARY

The Board Self-Test Code module can be used to check that peripheral elements used by the main demonstration program are operating correctly.

To run this code module:

1. Apply power to the dsPICDEM™ 1.1 Plus Development Board,
2. Press and hold down switch SW1 while pressing and releasing the Reset switch.
3. Release SW1.

At this point, the dsPIC DSC device enters into a basic test code execution loop while displaying the test code results on the LCD. The following data is displayed on the LCD:

- RP1-RP3 – As the potentiometers are rotated through their range, the displayed value will vary from 0 to 0FFF.
- When SW1-SW4 are depressed, LED1-LED4 should light, respectively.
- At 25°C/77°F, the temperature sensor will yield a count of approximately 26x-27x. Touching U9 (TC1047A temperature sensor) should increase this count.
- A running counter is being sent to the Codec and read back when pins 2 and 3 of J12 are connected together. There is an attenuation factor and a large phase shift so the value will not be the same but the counter should be incrementing. (Jumper J9 must be configured for the Slave setting.)
- A running counter is sent to the MCP41010 digital potentiometer. The D POT value should be counting on the LCD.

When pin J2-3 is connected to J5-2 and pin J2-2 is connected to J5-3, "OK" will appear on the lower right corner of the screen at power-up.

Chapter 4. Using dsPIC33F and PIC24H/24F Devices

4.1 INTRODUCTION

This chapter is a self-paced tutorial to help you get started using the dsPICDEM™ 1.1 Plus Development Board with dsPIC33F and PIC24H/24F devices. The tutorial demonstrates the main features of MPLAB IDE Integrated Development Environment and the MPLAB ICD 2 In-Circuit Debugger as they are used with the dsPICDEM™ 1.1 Plus Development Board. Upon completing this tutorial, you should be able to:

- Create a project using the Project Wizard.
- Assemble and link the code and set the Configuration bits.
- Set up MPLAB IDE to use the MPLAB ICD 2 In-Circuit Debugger.
- Program the chip with the MPLAB ICD 2.
- View the code execution in program memory and source code.
- View registers in a Watch window.
- Set a breakpoint and make the code halt at a chosen location.
- Use the function keys to Reset, Run, Halt and Single Step the code.

4.2 HIGHLIGHTS

Items discussed in this chapter include:

- Tutorial Overview
- Creating the Project
- Building the Code
- Programming the Chip
- Debugging the Code
- Additional Code Examples

4.3 TUTORIAL OVERVIEW

The tutorial program in `Tutorial.c` displays text on the LCD and flashes an LED. The source file is used with a linker script file (`p33FJ256GP710.gld`) to form a complete project. The tutorial is a simple project that uses a single source code file. More complex projects might use multiple assembler and compiler source files as well as library files and precompiled object files. For simplicity, this tutorial uses only one source file.

There are four steps to this tutorial:

1. Create a project in MPLAB IDE.
2. Compile and link the code.
3. Program the chip with the MPLAB ICD 2.
4. Debug the code with the MPLAB ICD 2.

4.4 CREATING THE PROJECT

The first step is to create a project and a workspace in MPLAB IDE. Usually, you will have one project in one workspace.

Note: These instructions presume the use of MPLAB 7.31 or newer.

A project contains the files needed to build an application (source code, linker script files, etc.) along with their associations to various build tools and build options.

A workspace contains one or more projects and information on the selected device, debug tool and/or programmer, open windows and their location, and other IDE configuration settings.

MPLAB IDE contains a Project Wizard to help create new projects. Before starting, create a folder for the project files for this tutorial (C:\Tutorial is assumed in the instructions that follow). From the dsPICDEM 1_1 Plus Development Board code\Tutorial Code for dsPIC33FJ256GP710 folder on the dsPICDEM™ 1.1 Plus Development Kit CD, copy the Tutorial.c file into the C:\Tutorial folder.

Note: All files copied from the CD are read only. If the file needs to be edited, the attributes will need to be changed.

4.4.1 Select a Device

1. Start MPLAB IDE.
2. Close any workspace that might be open (*File>Close Workspace*).
3. From the *Project* menu, select *Project Wizard*.
4. From the Welcome screen, click **Next>** to display the Project Wizard Step One dialog (see Figure 4-1).

FIGURE 4-1: PROJECT WIZARD, STEP 1, SELECT A DEVICE



Using dsPIC33F and PIC24H/24F Devices

- From the **Device:** pull-down list, select `dsPIC33FJ256GP710` and click **Next>**. The Project Wizard Step Two dialog displays (see Figure 4-2).

FIGURE 4-2: PROJECT WIZARD, STEP 2, SELECT LANGUAGE TOOLSUITE

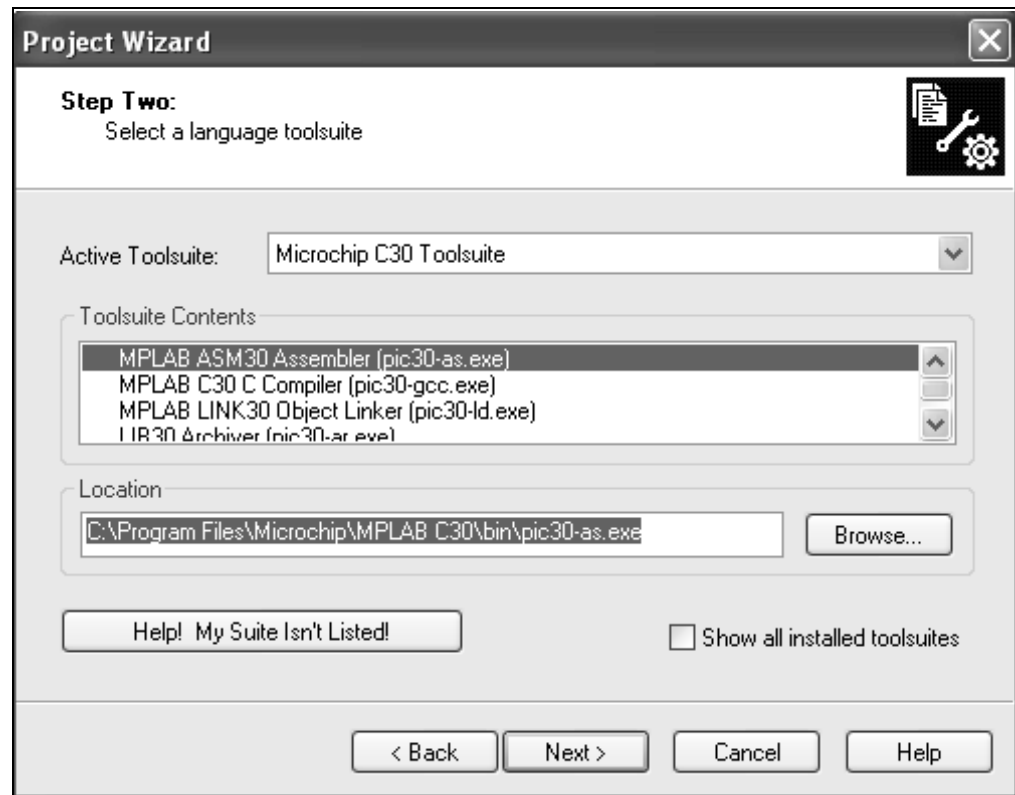

4.4.2 Select Language Toolsuite

- From the **Active Toolsuite:** pull-down menu, select **Microchip C30 Toolsuite**. This toolsuite includes the assembler and linker that will be used (the C Compiler is not used).
- Click **Next>** to continue. The Project Wizard Step Three dialog displays (see Figure 4-3).

Note: The tool locations for your environment may be different from those shown in this tutorial.

FIGURE 4-3: PROJECT WIZARD, STEP 3, NAME YOUR PROJECT

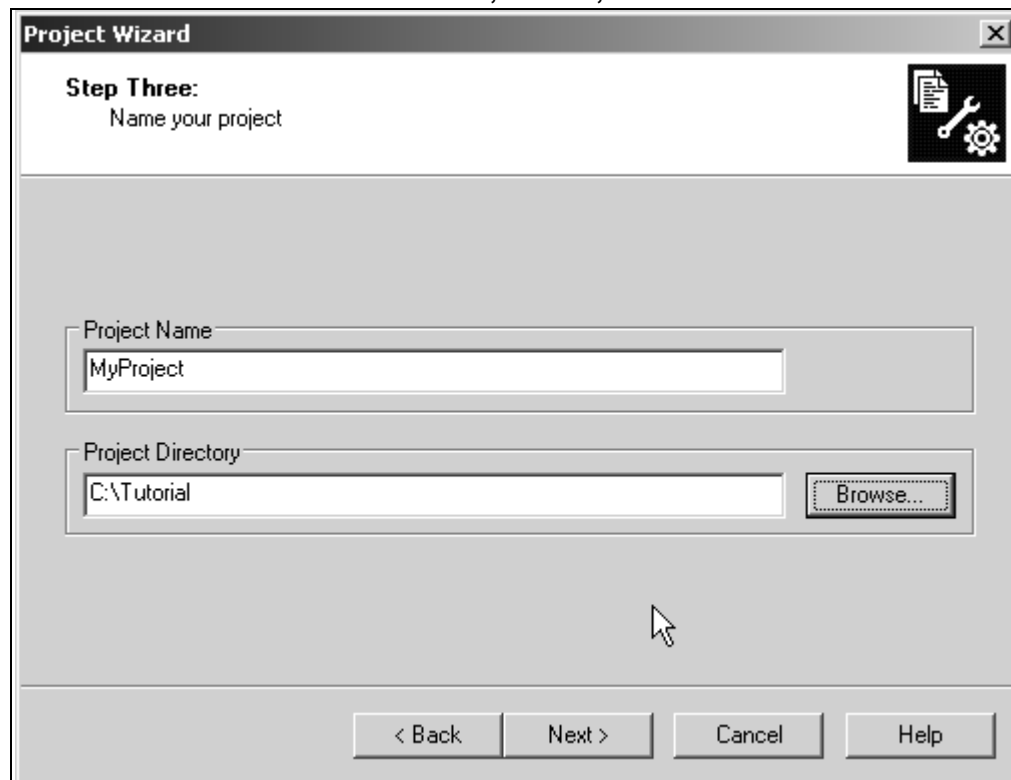

4.4.3 Name Your Project

1. In the **Project Name** text box, type **MyProject**.
2. Click **Browse...** and navigate to `C:\Tutorial` to place your project in the Tutorial folder.
3. Click **Next>** to continue. The Project Wizard Step Four dialog displays (see Figure 4-4).

FIGURE 4-4: PROJECT WIZARD, STEP 4, ADD FILES TO PROJECT

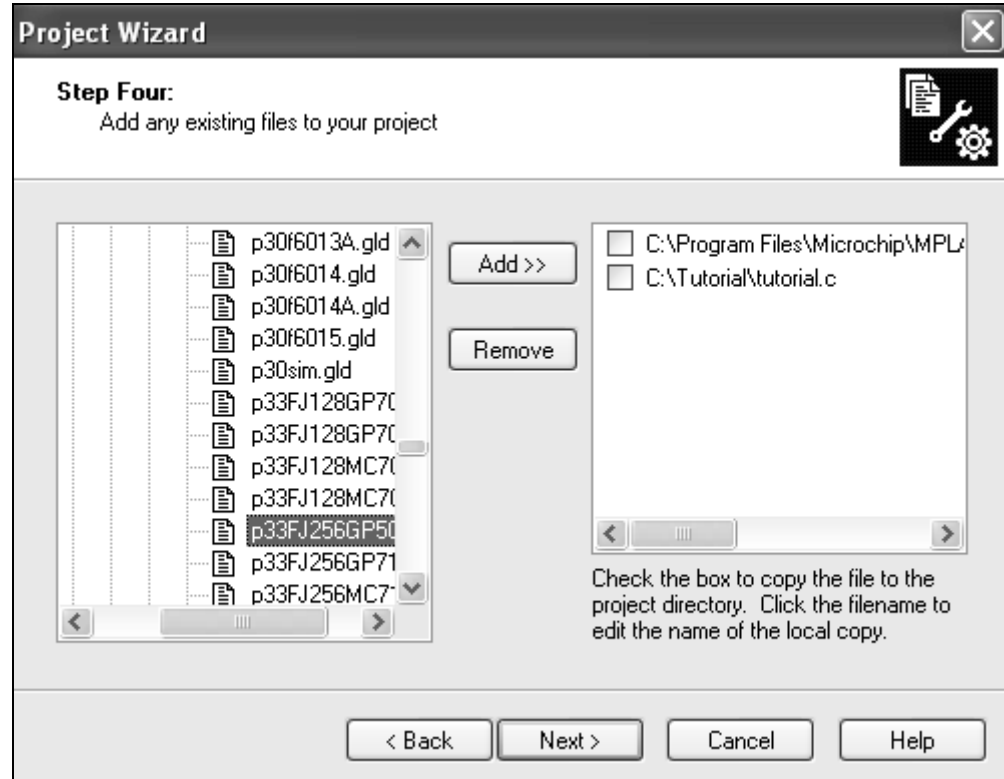

4.4.4 Add Files to Project

1. Locate the `C:\Tutorial` folder and select the `Tutorial.c` file.
2. Click **Add>>** to include the file in the project.
3. Expand the `C:\Program Files\Microchip\MPLAB C30\Support\gld` folder and select the `p33FJ256GP710.gld` file.
4. Click **Add>>** to include the file in the project. There should now be two files in the project.
5. Click **Next>** to continue.
6. When the summary screen displays, click **Finish**.

After the project wizard completes, the MPLAB IDE project window shows the `Tutorial.c` file in the **Source Files** folder and the `p33FJ256GP710.gld` file in the **Linker Scripts** folder (see Figure 4-5).

FIGURE 4-5: MPLAB® IDE PROJECT WINDOW

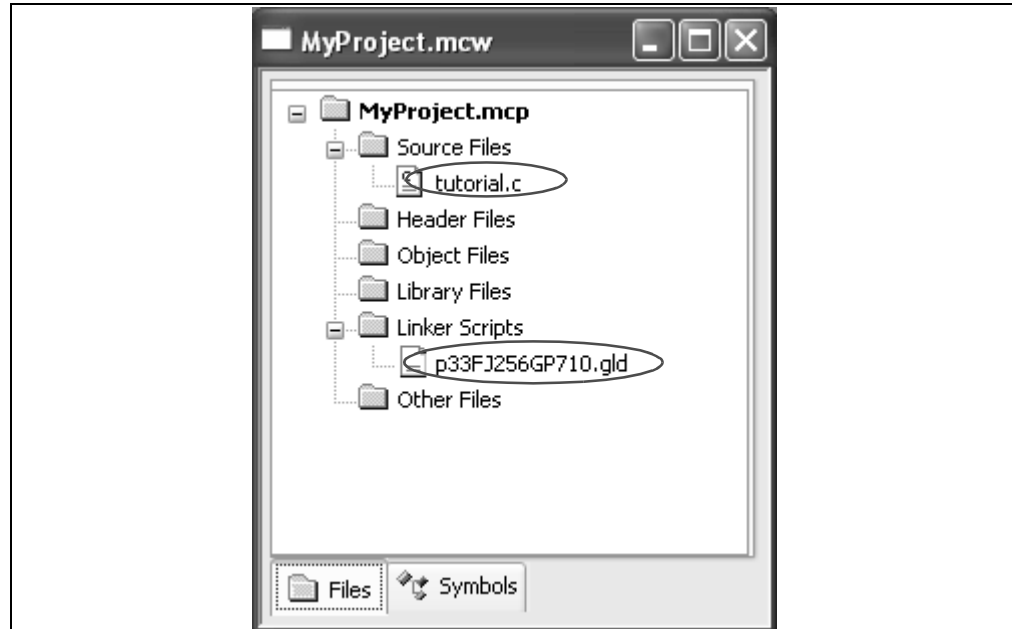

A project and workspace has now been created in MPLAB IDE. `MyProject.mcw` is the workspace file and `MyProject.mcp` is the project file. Double click the `Tutorial.c` file in the project window to open the file. MPLAB IDE should now look similar to Figure 4-6.

FIGURE 4-6: MPLAB® IDE WORKSPACE WINDOWS

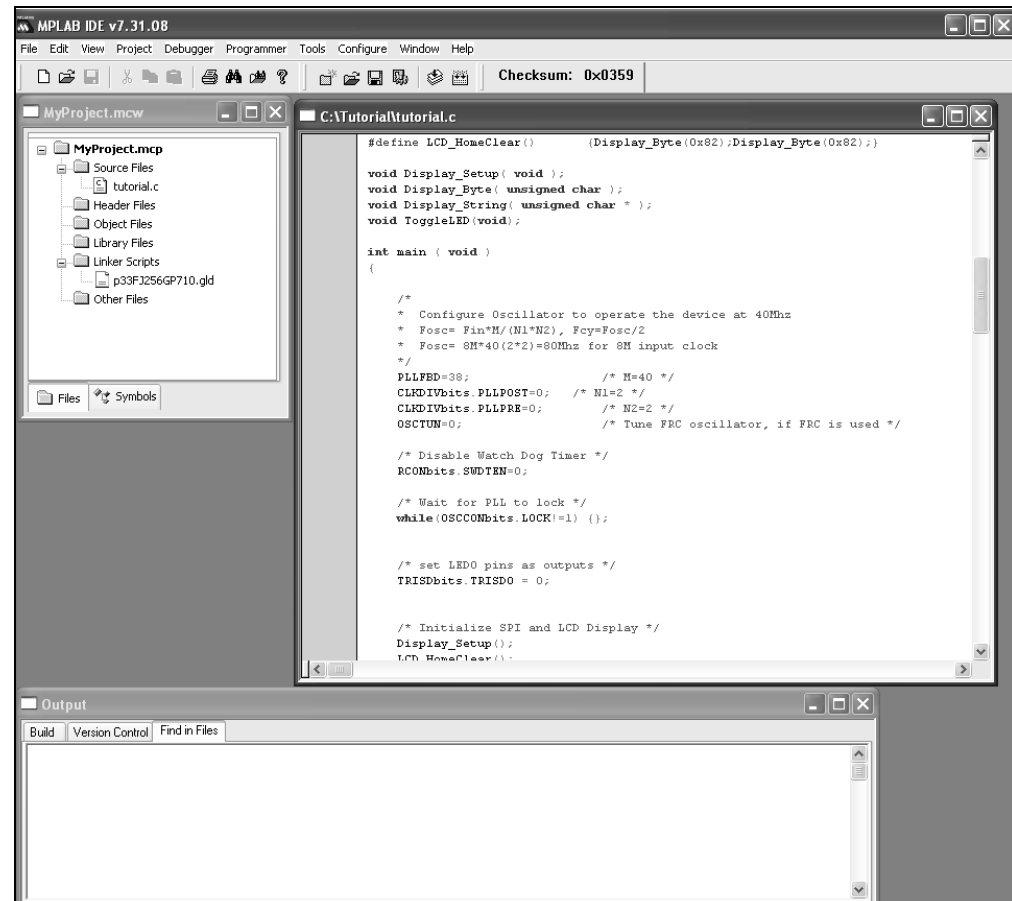

4.5 BUILDING THE CODE

In this project, building the code consists of compiling the `Tutorial.c` file to create an object file, `Tutorial.o`, and then linking the object file to create the `MyProject.hex` and `MyProject.cof` output files. The `.hex` file contains the data necessary to program the device and the `.cof` file contains additional information that lets you debug at the source code level.

Before building, there are settings required to tell MPLAB IDE to reserve space for the extra debug code when the MPLAB ICD 2 is used.

4.5.1 Link for ICD 2

1. Select **Build Options>Project** from the Project menu.
2. Select the MPLAB LINK30 tab to view the linker settings (see Figure 4-7).
3. Check **Link for ICD 2**.
4. Click **Apply**, then click **OK**. The text box closes while the linker reserves space for the debug code used by the MPLAB ICD 2.
5. Click **OK** again to save these changes. The project is now ready to build.

FIGURE 4-7: MPLAB® LINK30 BUILD OPTIONS

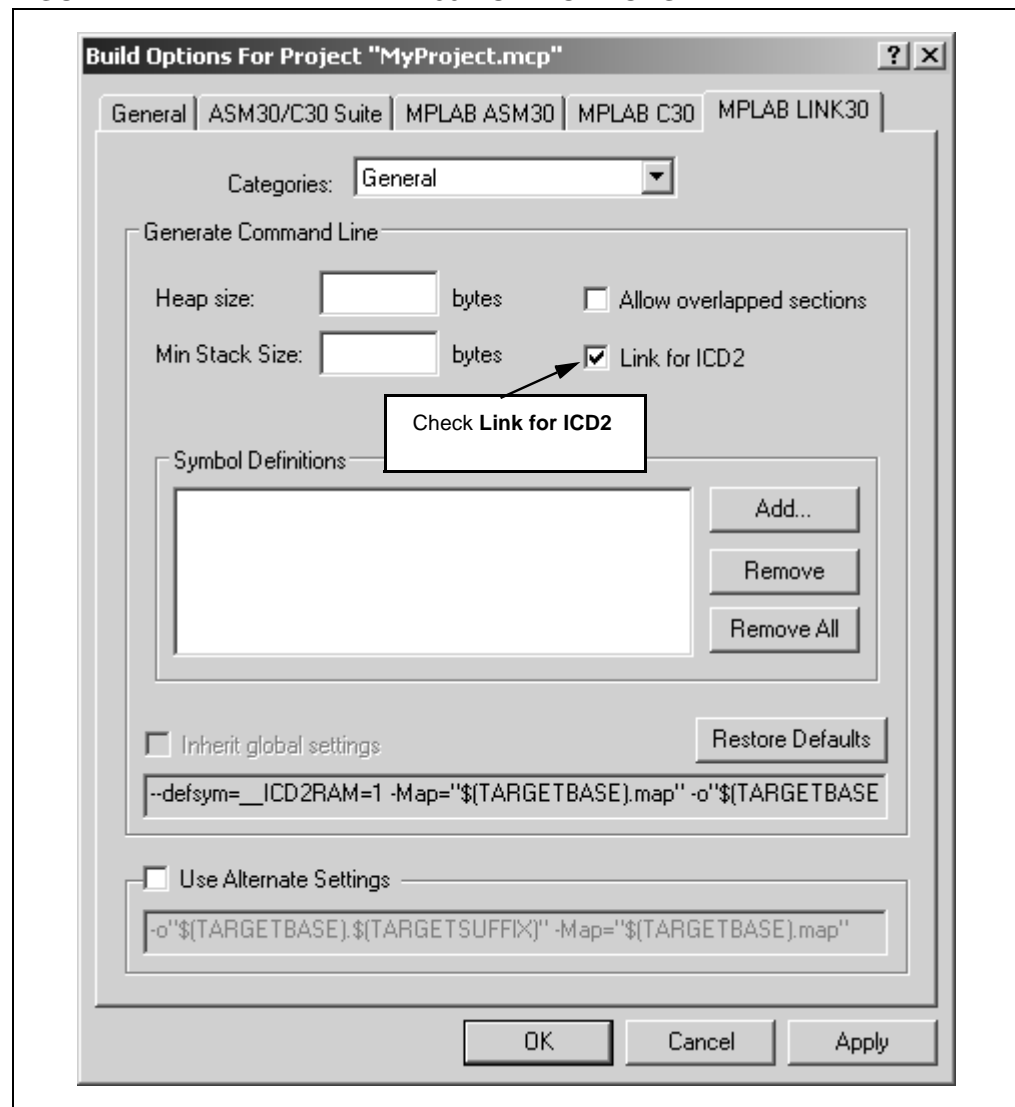

4.5.2 Build the Project

1. Select *Project>Build All*.
2. Observe the progress of the build in the Output window (Figure 4-8).
3. When BUILD SUCCEEDED displays you are ready to program the device.

FIGURE 4-8: BUILD OUTPUT WINDOW

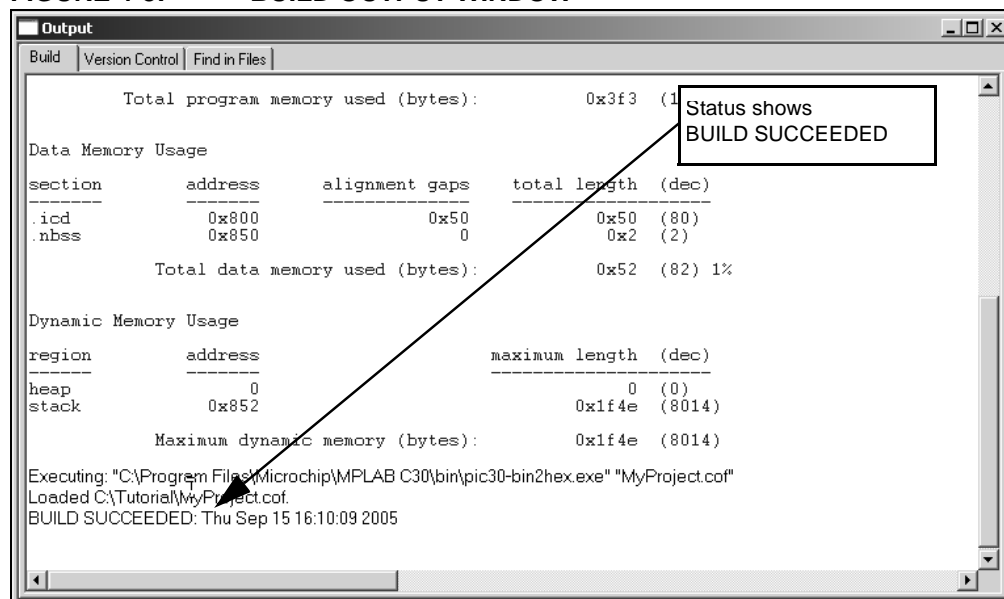

Using dsPIC33F and PIC24H/24F Devices

4.6 PROGRAMMING THE CHIP

The MPLAB ICD 2 In-Circuit Debugger can be used to program and debug the dsPIC33FJ256GP710 device in-circuit on the dsPICDEM™ 1.1 Plus Development Board.

Note: Before proceeding, make sure that the USB driver for the MPLAB ICD 2 has been installed on your PC (see the “MPLAB® ICD 2 User’s Guide”, DS51331) for more details regarding the installation of MPLAB ICD 2.

Use the following procedures to program the dsPIC33FJ256GP710 device.

4.6.1 Set Up the Device Configuration

1. Use the *Configure>Configuration Bits* menu to display the configuration settings.
2. Set up the Configuration bits as shown in Figure 4-9.

FIGURE 4-9: CONFIGURATION SETTINGS

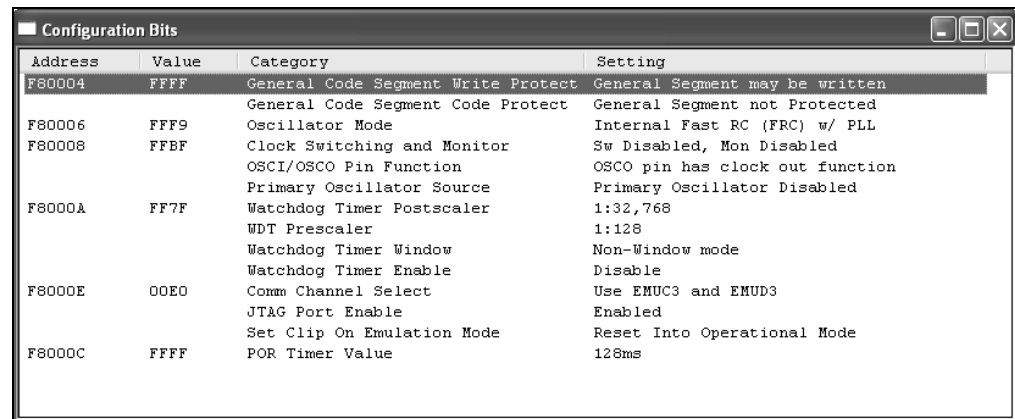

Address	Value	Category	Setting
F80004	FFFF	General Code Segment Write Protect	General Segment may be written
		General Code Segment Code Protect	General Segment not Protected
F80006	FFF9	Oscillator Mode	Internal Fast RC (FRC) w/ PLL
F80008	FFBF	Clock Switching and Monitor	Sw Disabled, Mon Disabled
		OSCI/OSCO Pin Function	OSCO pin has clock out function
		Primary Oscillator Source	Primary Oscillator Disabled
F8000A	FF7F	Watchdog Timer Postscaler	1:32,768
		WDT Prescaler	1:128
		Watchdog Timer Window	Non-Window mode
		Watchdog Timer Enable	Disable
F8000E	00E0	Comm Channel Select	Use EMUC3 and EMUD3
		JTAG Port Enable	Enabled
		Set Clip On Emulation Mode	Reset Into Operational Mode
F8000C	FFFF	POR Timer Value	128ms

4.6.2 Connect the MPLAB ICD 2 In-Circuit Debugger

1. Before setting up the hardware, check that the following jumpers are in place:
 - AVDD_JMP: On
 - J8: 33F PGD3/30F, 33F PGC3/30F
 - J10: MCLR1
 - VDD_JMP: On
2. Reconfigure the board for 3.3V operation by removing jumpers J21 and J22.
3. Install the dsPIC33FJ256GP710 PIM into J11, J13, J14 and J15.
4. Connect the MPLAB ICD 2 to the PC with the USB cable (see Figure 4-10).
5. Connect the MPLAB ICD 2 to the dsPICDEM™ 1.1 Plus Development Board with the short RJ-11 (telephone) cable.
6. Apply power to the board.

FIGURE 4-10: dsPICDEM™ 1.1 PLUS DEVELOPMENT BOARD CONNECTED TO MPLAB® ICD 2 IN-CIRCUIT DEBUGGER

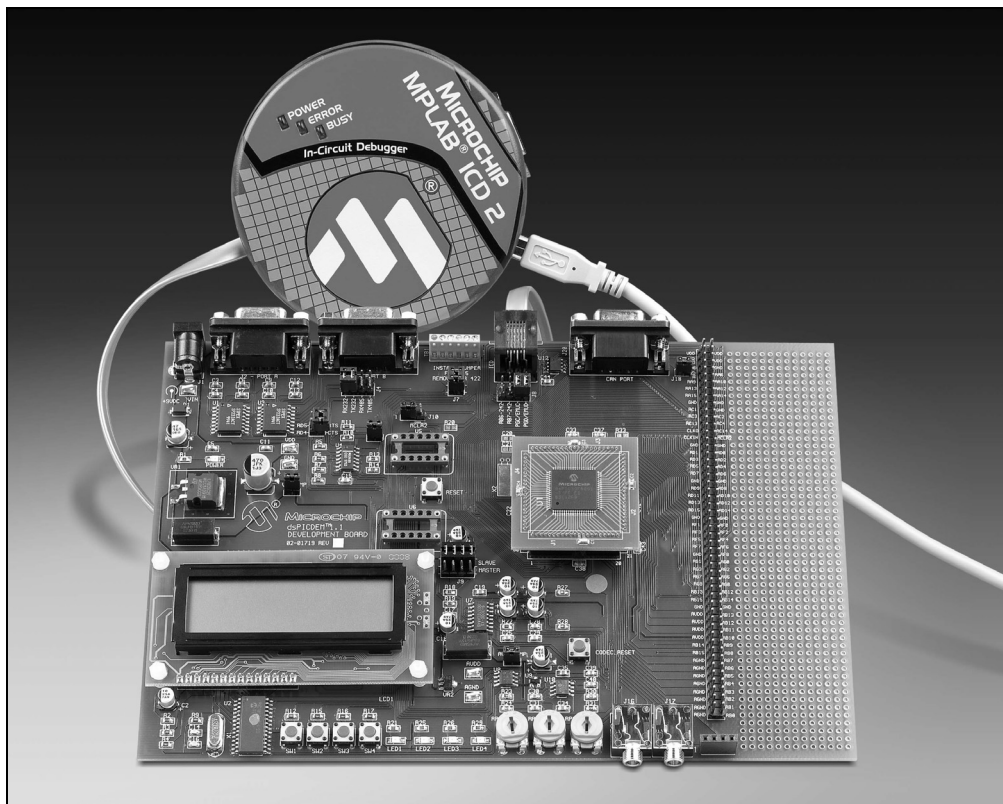

4.6.3 Enable MPLAB ICD 2 Connection

1. From the *Debugger* menu, click *Select Tool>MPLAB ICD 2* to designate the MPLAB ICD 2 as the debug tool in MPLAB IDE.
2. From the *Debugger* menu, select *Connect* to connect the debugger to the device. The MPLAB ICD 2 should report that it found the dsPIC33FJ256GP710 device, as shown in Figure 4-11.

Note: MPLAB IDE may need to download new firmware if this is the first time the MPLAB ICD 2 is being used with a dsPIC33F device. Allow it to do so. If any errors are shown, double click the error message to get more information.

FIGURE 4-11: ENABLING MPLAB® ICD 2

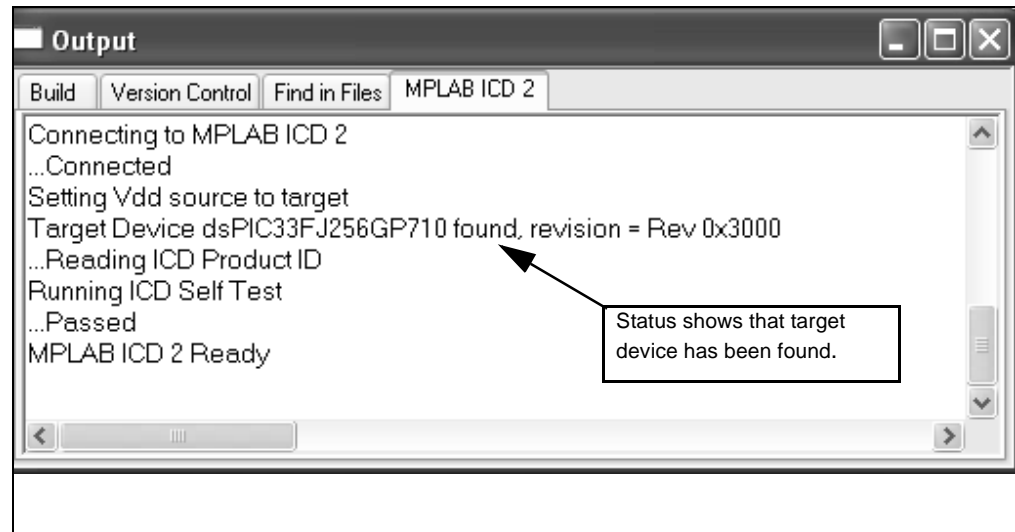

3. From the *Debugger* menu, click *Settings* to display the MPLAB ICD Debugger settings.
4. Select the Program tab.
5. Check **Allow ICD 2 to select memories and ranges**, as shown in Figure 4-12. This setting will speed up operations by programming only a small part of the total program memory.

FIGURE 4-12: SETTING PROGRAM MEMORY SIZE

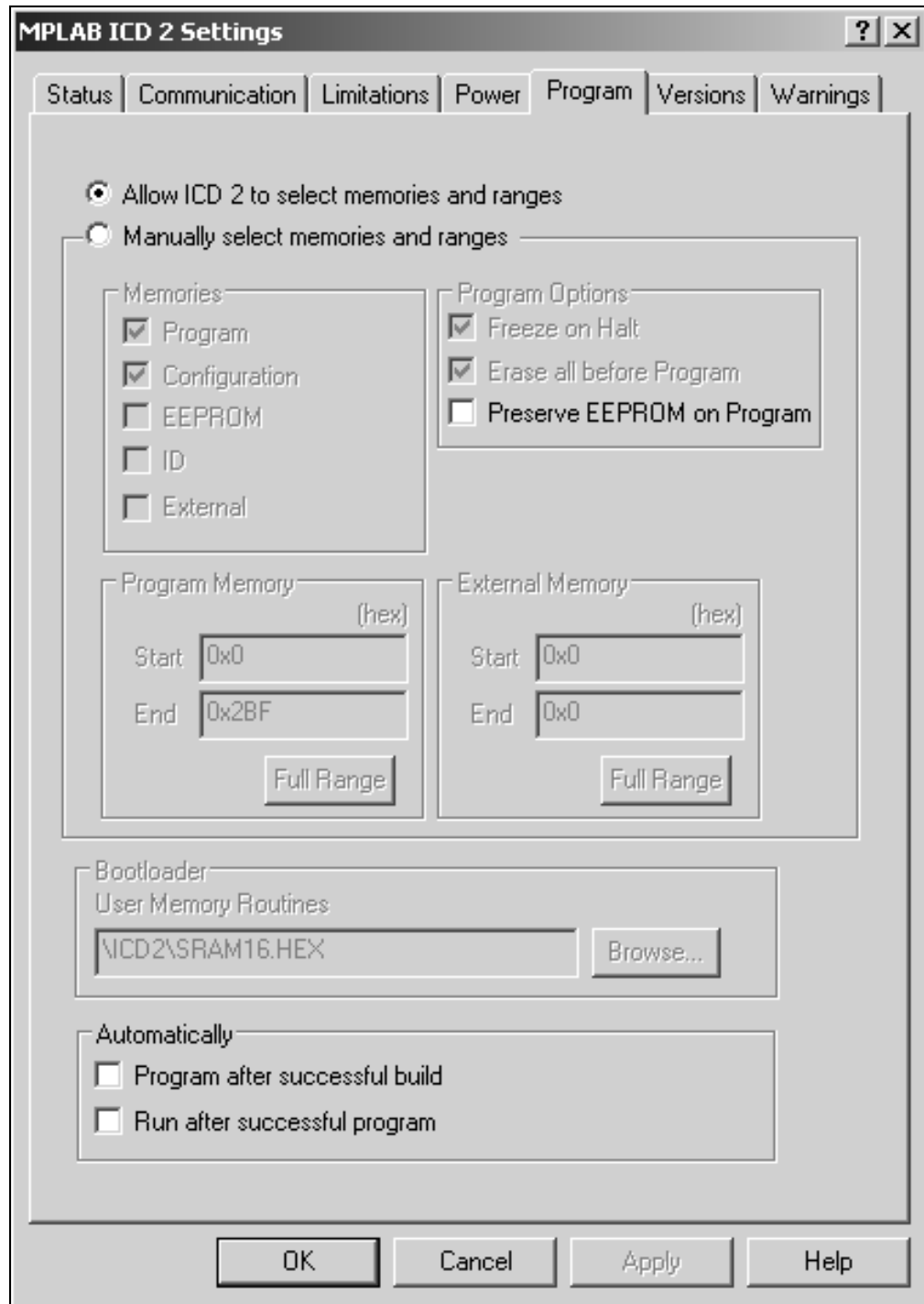

4.6.4 Program the dsPIC33FJ256GP710 Device

1. From the *Debugger* menu, select *Program*. The Output window (Figure 4-13) displays the program steps as they occur.
2. Observe the process in the Output window. When “MPLAB ICD 2 Ready” displays, the device is programmed and ready to run.

FIGURE 4-13: PROGRAMMING THE dsPIC30F6014A DEVICE

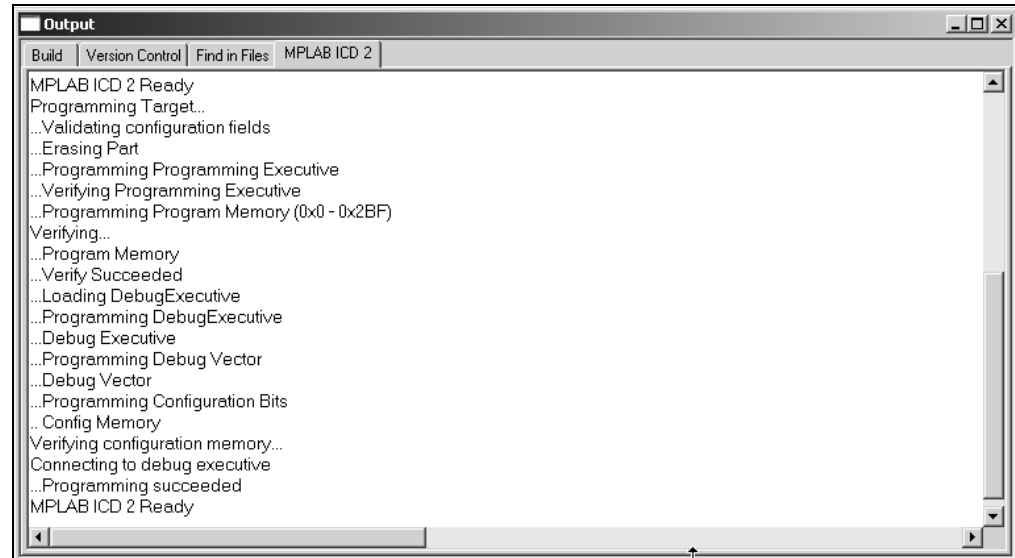

3. Use the *Debugger>Reset* menu to reset the code, then *Debugger>Run* to run the code. LED1 should start blinking and the LCD display should show the text in Figure 4-14.

FIGURE 4-14: TUTORIAL LCD DISPLAY

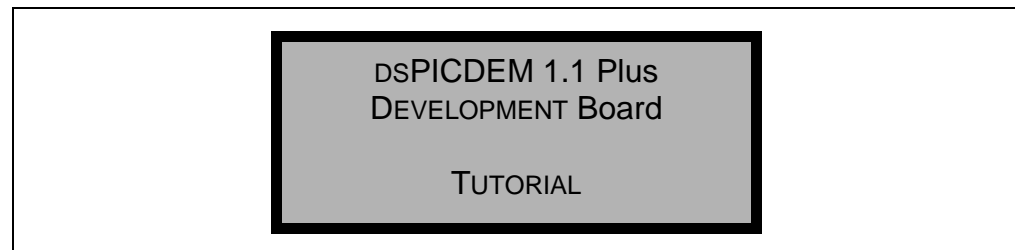

4.7 DEBUGGING THE CODE

The MPLAB ICD 2 In-Circuit Debugger can be used to run, halt and step the code. A breakpoint can be set to halt the program after the code has executed the instruction at the breakpoint. The contents of the RAM and registers can be viewed whenever the processor has been halted.

The MPLAB ICD 2 In-Circuit Debugger uses the following function keys to access the main debugging functions:

- | | |
|------|-------------|
| <F5> | Halt |
| <F6> | Reset |
| <F7> | Single Step |
| <F9> | Run |

In addition, there are more functions available by right clicking on a line of source code. The most important of these are “Set Breakpoint” and “Run to Cursor”.

4.7.1 Display the Code

1. From the View menu, select Program Memory.
2. On the Program Memory window, select the **Symbolic** tab, as shown in Figure 4-15.

FIGURE 4-15: PROGRAM MEMORY WINDOW

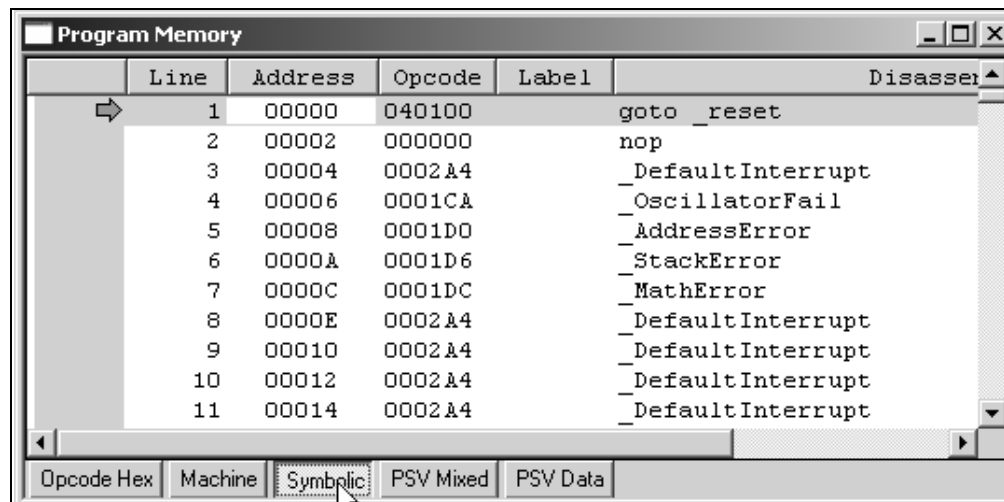

3. Press <F5> to halt the processor and press <F6> to reset. The program memory now shows a green arrow pointing to the line of code at address 0, the Reset location.

The instruction at this location is `goto __reset`. This code is added by the linker to make the program branch to the initialization and main code located in the `tutorial.c` file.

Using dsPIC33F and PIC24H/24F Devices

4.7.2 Step the Program

1. Press <F7> to single step the code. The green arrow now points to the code at `_reset`, as shown in Figure 4-16.
2. Right click the line of code `call main` and choose *Run to Cursor*. The green arrow then points to the first instruction in the main routine.

FIGURE 4-16: SOURCE CODE WINDOW

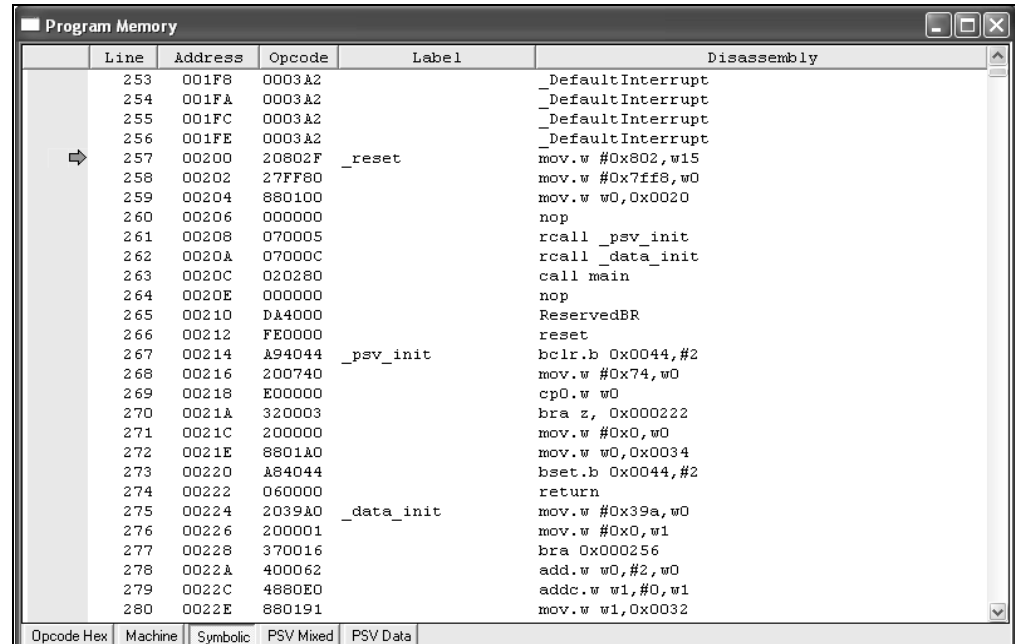

3. From the *View* menu, select *Watch* to open a Watch window (Figure 4-17).
4. From the **Add SFR** pull-down list, display **PLLFB**D.
5. Click **Add SFR** to add the PLLFB D register to the Watch window.
6. Next, select **CLKDIV** from the pull-down list and click **Add SFR**.
7. Press <F7> a few times and watch the values of these SFRs change.

FIGURE 4-17: WATCH WINDOW DISPLAY

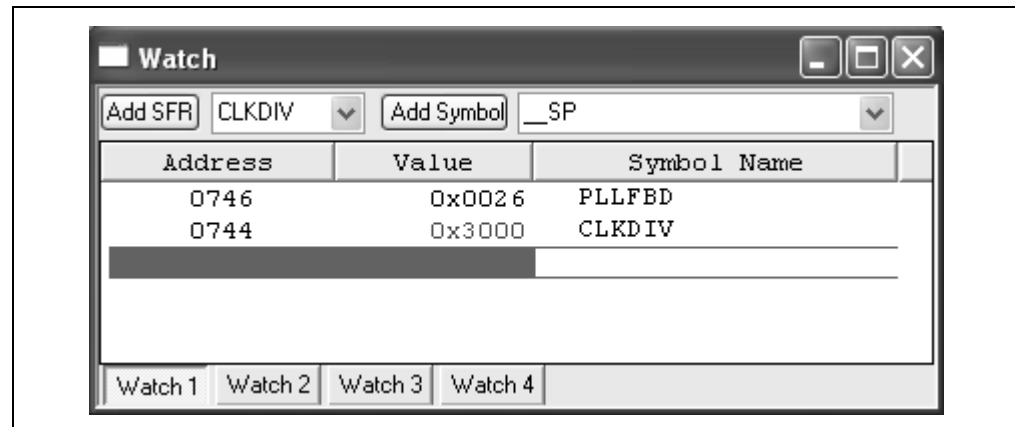

4.7.3 Set Breakpoint

1. To set a breakpoint, right click a code line and select Set Breakpoint from the pop-up menu.

Note: An alternate method is to simply double click the line. This feature may need to be enabled using the Edit>Properties menu.

As an example, find the following line of code and set a breakpoint on this line.

```
ToggleLED ();
```

A red stop sign should appear in the gutter (gray bar on the left) of the source code window.

2. Press <F9> to run the code. The program halts on the instruction following the breakpoint.

Note: The instruction on which the code halts could be elsewhere in the code if the breakpoint was set on or immediately after a branch instruction. Refer to Section 12, "Important Notes", in the Readme file for the MPLAB ICD 2.txt file located in the E:\MPLAB IDE\READMES directory for additional operational information.

4.8 ADDITIONAL CODE EXAMPLES

The dsPICDEM™ 1.1 Plus Development Board Kit CD contains additional code examples that exercise various features and peripherals of the dsPIC33F device:

CE111 – External Interrupt Pins:

Microchip's 16-bit dsPIC Digital Signal Controllers feature up to 5 external interrupt pins: INT0 through INT4. These pins may be configured to interrupt on either a rising or a falling edge of a signal.

This code example, written in C, demonstrates how the external interrupt pins can be configured to interrupt the CPU. Both initialization and interrupt service routines have been provided.

CE113 – Timer1 Used in Real-Time Clock Applications:

dsPIC Digital Signal Controllers feature several on-chip general purpose timers. Of these, the Timer1 module has the capability to be clocked by an external asynchronous 32 kHz crystal connected to the device via the SOSCI and SOSCO pins. The attached code example demonstrates how Timer1 may be configured to use the 32 kHz secondary oscillator for a real-time clock (RTC) application.

Configuring Timer1 for the real-time clock application is a two step process. In the first step, the code demonstrates how the secondary oscillator can be enabled via a special write sequence to the OSCCON register. In the second step, the code demonstrates how the Timer1 is configured to use an external asynchronous clock. In addition to these steps, the code also demonstrates Timer1 interrupt operation.

CE114 – UART Loopback:

In this code examples, 256 byte transmit buffer is transmitted using UART and received back in the receive buffer. This operation happens continuously.

CE121 – ADC Channel Scanning:

In this example, Timer 3 is set up to time-out every 125 microseconds (8 kHz rate). As a result, the module stops sampling and triggers an A/D conversion on every Timer3 time-out (i.e., $T_s=125\mu s$).

ADC is configured in 10-bit mode to sequentially scan AIN0, AIN1, AIN2, AIN3, AIN4 and AIN5 on Timer 3 interrupt. It takes six Timer3 time-out periods to scan through all the six analog inputs.

dsPICDEM™ 1.1 Plus Development Board User's Guide

NOTES:

Chapter 5. dsPICDEM™ 1.1 Development Hardware

5.1 dsPICDEM™ 1.1 PLUS DEVELOPMENT BOARD HARDWARE OVERVIEW

This chapter describes the dsPICDEM™ 1.1 Plus Development Board hardware. This development board features the hardware elements shown in Figure 5-1.

FIGURE 5-1: dsPICDEM™ 1.1 PLUS DEVELOPMENT BOARD

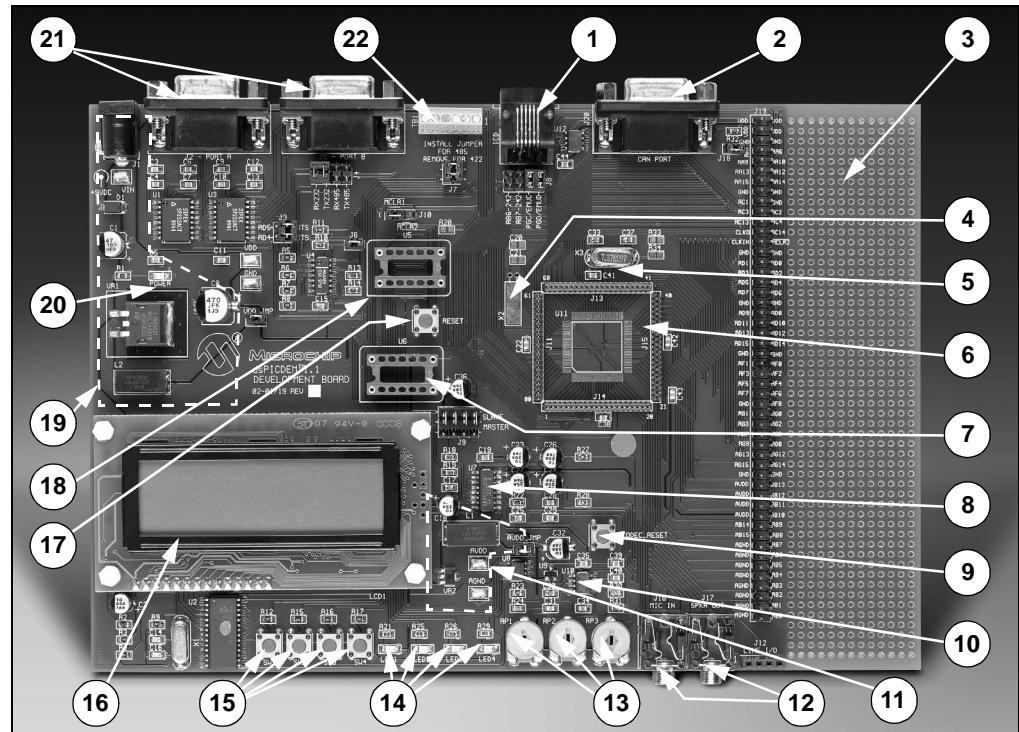
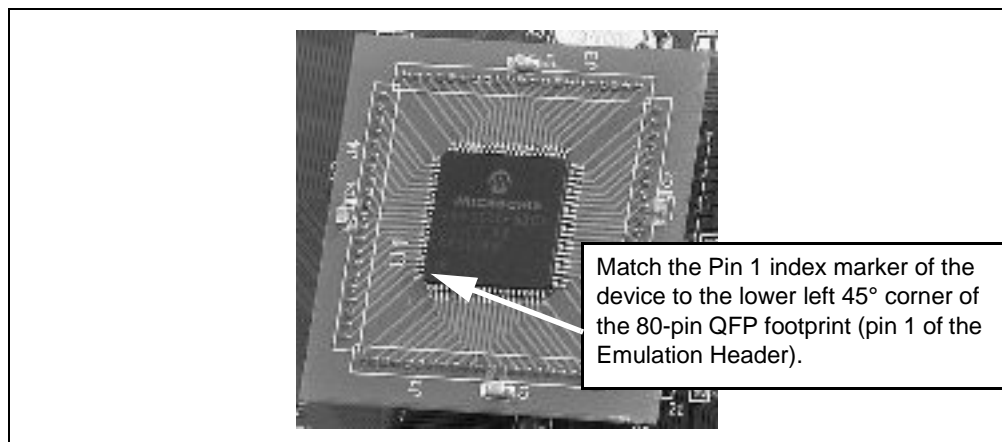

TABLE 5-1: dsPICDEM™ 1.1 PLUS DEVELOPMENT BOARD HARDWARE

No.	Hardware Element	No.	Hardware Element
1	ICD Connector (Section 5.1.10)	12	Stereo Jacks (Section 5.1.11)
2	CAN Port (Section 5.1.2)	13	Analog Potentiometers (Section 5.1.5)
3	Prototyping Area (Section 5.1.17)	14	LEDs (Section 5.1.7)
4	Oscillator X2 (Section 5.1.15)	15	Push Button Switches (Section 5.1.6)
5	Oscillator X3 (Section 5.1.15)	16	LCD Graphic Display (Section 5.1.9)
6	Emulation Headers ⁽¹⁾ (Section 5.1.12)	17	Reset Switch (Section 5.1.16)
7	Si3000 External Clock Socket (Section 5.1.11)	18	Canned Crystal Socket (Section 5.1.15)
8	Si3000 Codec (Section 5.1.11)	19	VDD Regulator (Section 5.1.13)
9	Codec Reset Switch (Section 5.1.11)	20	Power-on LED (Section 5.1.14)
10	Temperature Sensor (Section 5.1.4)	21	RS-232 Serial Ports (Section 5.1.1)
11	AVDD Regulator (Section 5.1.13)	22	RS-485/RS-422 Port (Section 5.1.3)

Note 1: See Plug-in Module shown in Figure 5-2.

FIGURE 5-2: DEVICE PLUG-IN MODULE



5.1.1 RS-232 Serial Ports

Two RS-232 serial communication channels are provided on the dsPICDEM™ 1.1 Plus Development Board. One serial communication channel (DB9 connector J5/PORTB) can be configured as an RS-232 or RS-485/RS-422 communication channel by setting jumper J4 to the RX232/TX232 position. This jumper position connects the dsPIC DSC UART channel 1 U1RX and U1TX pins to an RS-232 level-shifting IC (U3).

The serial port is configured as Data Communication Equipment (DCE), and can be connected to a PC using a straight-through cable. If hardware handshaking is required, inserting jumper J3 will connect CTS and RTS to port pins RD4 and RD5 on the dsPIC DSC device. These pins can support CTS/RTS through a bit-bang control approach. Both pins are connected to IC U3.

Setting jumper J4 to the TX485/RX485 position configures the dsPIC DSC UART channel 1 U1RX and U1TX pins for a RS-485/RS-422 communication channel.

The second serial communication channel (DB9 connector J2/PORT A) is connected to the dsPIC DSC UART channel 2 U2RX and U2TX pins via RS-232 level-shifting IC (U1). This channel is a dedicated RS-232 serial communication channel. Hardware flow control is not provided.

The schematic of these ports is shown in **Figure A-5: “dsPICDEM™ 1.1 Plus Development Board Schematic (Sheet 4 of 5)”**

5.1.2 CAN Port

The CAN RXD and TXD lines of the SN65HVD230DR are connected to the dsPIC DSC CANRX and CANTX pins. CAN bus signals (CANH and CANL) are available on DB9 connector J20. The CANH and CANL bus can be locally terminated with a 120 ohm resistor by inserting jumper, J18.

The schematic of the CAN port is shown in **Figure A-5: “dsPICDEM™ 1.1 Plus Development Board Schematic (Sheet 4 of 5)”**.

5.1.3 RS-485/RS-422 Port

Signals for the RS-485/RS-422 port are available on the 6-pin terminal block labeled TB1. The terminal block can be reconfigured from RS-485 to RS-422 by removing the jumper on J7. Inserting jumper J6 will terminate the bus with a 120-ohm resistor.

The RX485 and TX485 lines of the MAX3491E can be tied to the dsPIC DSC UART channel 1 U1RX and U1TX pins by moving the jumper on J4 to the TX485/RX485 position.

MAX489E receiver and driver output enables are controlled by port pins RG0 and RG1, respectively.

The RS-485 and RS-422 port schematic is shown in **Figure A-5: “dsPICDEM™ 1.1 Plus Development Board Schematic (Sheet 4 of 5)”**.

5.1.4 Temperature Sensor

Temperature sensor U9 is a -40°C to +125°C linear output TC1047A connected to analog channel AN8 of the dsPIC DSC device. The output of the temperature sensor is fed through a second-order low-pass filter before connection to the dsPIC DSC device. The low-pass filter cutoff frequency is set at 10 Hz. The output voltage range for the TC1047A is typically 750 mV at +25°C. The TC1047A exhibits a typical 10 mV/C voltage slope.

The schematic of the temperature sensor is shown in **Figure A-4: “dsPICDEM™ 1.1 Plus Development Board Schematic (Sheet 3 of 5)”**.

5.1.5 Analog Potentiometers

Three 5 kOhm potentiometers are connected to analog channels AN4 (RB4), AN5 (RB5) and AN6 (RB6). The voltage output range for each potentiometer is between 0V DC and 5V DC. The voltage source is provided by VR2, which is a separate voltage source for all the analog components on the development board.

The schematic of the analog potentiometers is shown in **Figure A-4: “dsPICDEM™ 1.1 Plus Development Board Schematic (Sheet 3 of 5)”**.

5.1.6 Push Button Switches

Switches SW1-SW4 are connected to port pins RA12-RA15, respectively, on the dsPIC DSC device. The signal lines are normally pulled up to +5V DC through 10 kOhm resistors. Pressing the switch will short the line to ground. Port pins RA12-RA15 are configured as the INT1-INT4 external interrupt pins.

The schematic of the push button switches is shown in **Figure A-4: “dsPICDEM™ 1.1 Plus Development Board Schematic (Sheet 3 of 5)”**.

5.1.7 LEDs

Four red LEDs, LED1-LED4, are connected to port pins RD0-RD3, respectively, on the dsPIC DSC device. The LED anodes are tied to VDD through a 1.2 kOhm resistor.

The schematic of the LEDs is shown in **Figure A-4: “dsPICDEM™ 1.1 Plus Development Board Schematic (Sheet 3 of 5)”**.

5.1.8 Digital Potentiometer

A single channel digital potentiometer, MCP41010, is provided on the development board. Control of the digital potentiometer is via the dsPIC DSC SPI 2 communication channel. The output of the digital potentiometer is applied to a low-pass filter with a cutoff frequency of approximately 4 kHz. The output of the LP filter is connected to the analog channel AN3 of the dsPIC DSC device.

The schematic of the digital potentiometers is shown in **Figure A-4: “dsPICDEM™ 1.1 Plus Development Board Schematic (Sheet 3 of 5)”**.

5.1.9 LCD Graphic Display

The LCD graphic display is a PG12232D-L 8-bit 122 x 32 dot-matrix LCD controlled by a PIC18F242 LCD controller. The dsPIC30F device accesses the LCD controller via the SPI 2 port. For a detailed description of the communication protocol, see **Appendix B. “LCD Controller Specification”**.

The LCD PIC18F242 controller is reset by setting jumper J10 to the $\overline{\text{MCLR2}}$ position and pressing the Reset switch. Moving jumper J10 back to the $\overline{\text{MCLR1}}$ position returns Reset control of the dsPIC30F device.

The schematic of the analog potentiometers is shown in **Figure A-6: “dsPICDEM™ 1.1 Plus Development Board Schematic (Sheet 5 of 5)”**.

5.1.10 ICD Connector

Using modular connector ICD, the MPLAB ICD 2 can be connected for low-cost programming and debugging of the dsPIC30F/33F or PIC24H/24F device.

- Programming and debugging of dsPIC30F devices requires that jumper J8 is set to the 30F position and jumper J10 is set to the $\overline{\text{MCLR1}}$ position.
- Programming and debugging of dsPIC33F/PIC24H/PIC24F devices requires that jumper J8 is set to the 33F PGC1 and 33F PGD1 (or to the 33F PGC3 and 33F PGD3) position and jumper J10 is set to the $\overline{\text{MCLR1}}$ position.

Programming the PIC18F242 LCD controller requires that jumper J8 is set to the RB6/242 and RB7/242 position and jumper J10 is set to the $\overline{\text{MCLR2}}$ position. The PIC18F242 LCD controller is programmed at the factory with the LCD driver code. Under normal operating conditions, no additional programming should be required for this device.

The schematic of the analog potentiometers is shown in **Figure A-6: “dsPICDEM™ 1.1 Plus Development Board Schematic (Sheet 5 of 5)”**

5.1.11 Si3000 Voice Band Codec

An Si3000 Codec from Silicon Labs is included on the development board. Stereo Jacks provide MIC input on J16 and SPKR OUT output on J17. LINE I/O on J12 provides line-in and line-out connections. J9 provides a selection for Master or Slave operation for the Si3000. When the Si3000 is operated in Master mode, the user must provide a suitable clock oscillator in the U6 socket. The CODEC RESET switch resets the Si3000.

For detailed operational information, refer to the Si3000 data sheet available on www.silabs.com. For a schematic of the Si3000 circuit, see **Figure A-6: “dsPICDEM™ 1.1 Plus Development Board Schematic (Sheet 5 of 5)”**.

5.1.12 Emulation Header

Headers J11 and J13-J15 provide a connection to the MPLAB ICE 4000 In-Circuit Emulator. The emulation headers also support Plug-in Modules containing dsPIC30F, dsPIC33F, PIC24H and PIC24F devices soldered onto adaptor boards (see Section 5.1.18). These Plug-in Modules facilitate quick change out of the 80-pin TQFP device.

The schematic of the Emulation Header is shown in **Figure A-2: “dsPICDEM™ 1.1 Plus Development Board Schematic (Sheet 1 of 5)”**.

5.1.13 Power Supply

The dsPICDEM™ 1.1 is powered by a +9V AC/DC wall adapter. Separate +3.3 V/+5V DC regulators (VDD and AVDD) are provided to their respective processor pins and prototyping area. Separate ground planes are connected through a single point.

CAUTION

Jumpers J21 and J22 are used to select +3.3V or +5V operation. An incorrect jumper setting can damage dsPIC30F/33F or PIC24H/24F Plug-In Modules. Configure for +5V operation with dsPIC30F devices only. Configure for +3.3V operation for all other devices.

Jumpers VDD_JMP and AVDD_JMP allow the supplied power source to be bypassed and alternate supplies to be provided.

The schematics of the power supply circuits are shown in **Figure A-3: “dsPICDEM™ 1.1 Plus Development Board Schematic (Sheet 2 of 5)”**.

5.1.14 Power-on Indicator

A green LED is connected to the input of the regulators to indicate the presence of power. See **Figure A-3: “dsPICDEM™ 1.1 Plus Development Board Schematic (Sheet 2 of 5)”**.

5.1.15 Oscillator Options

- Crystal oscillator (7.3728 MHz) is supplied with the development board.
- Through holes and pads are provided for a user-furnished watch-type crystal and two capacitors for SOSC1 and SOSC2.
- Socket and pads are provided for an output pull-up resistor for user furnished oscillator to processor.
- External clock connections from J1.

dsPICDEM™ 1.1 Plus Development Board User's Guide

Oscillator selection parameters are shown in Table 5-2.

TABLE 5-2: OSCILLATOR SELECTION PARAMETERS⁽¹⁾

Oscillator Selection on dsPICDEM™ 1.1 Plus Demo Board	Modifications on dsPICDEM™ 1.1 Plus Demo Board
Crystal (X3)	R33, R34, R20, C20, C21 and X2 open, U5 empty. Crystal in X3, caps in C33 and C37.
Mini Crystal (X2)	R20, R33, R34, C33, C37 and X1 open, U5 empty. Crystal in X2, caps in C20 and C21.
Canned Oscillator (U5)	R20, R33, R34, C20, C21, C33, C37, X2 and X3 open, U5 installed.
RC	R33, R34, C20, C21, C33, X2 and X3 open, U5 empty. Cap in C37 and resistor in R20.
External Clock	R20, C20, C21, C33, C37, U5, X2 and X3 open. 0 ohm installed for R33 and R34.

Note 1: The oscillator circuit schematics are shown in **Figure A-2: “dsPICDEM™ 1.1 Plus Development Board Schematic (Sheet 1 of 5)”**

5.1.16 Reset Switch

By placing J10 jumper in the MCLR1 position, the Reset switch connected to the processor MCLR pin provides a hard Reset to the dsPIC DSC device. By placing J10 jumper in the MCLR2 position, the Reset switch is connected to the PIC18F242 LCD controller.

The Reset switch circuit is shown in **Figure A-2: “dsPICDEM™ 1.1 Plus Development Board Schematic (Sheet 1 of 5)”**.

5.1.17 Prototyping Area

A prototyping area and associated header are provided on the development board to enable additional ICs and attachment boards to be added (see **Figure A-2: “dsPICDEM™ 1.1 Plus Development Board Schematic (Sheet 1 of 5)”**).

5.1.18 Sample Devices

A sample dsPIC DSC device programmed with the demonstration code is included in the dsPICDEM™ 1.1 Plus Development Board Kit. The 80-pin TQFP is soldered to a 1.5" x 1.5" adaptor PCB, which is inserted onto the emulation header, J11 and J13-J15.

Handle the device carefully when inserting and extracting the adaptor board. The orientation of the adaptor board is important. The Microchip logo and device part numbering should be aligned to read from left to right before insertion of the adaptor board. The pin 1 index marker of dsPIC30F device should align with the lower left 45° corner of the 80-pin QFP footprint (pin 1 of Emulation Header J14).

Pin-out information for the emulation header is shown in **Figure A-2: “dsPICDEM™ 1.1 Plus Development Board Schematic (Sheet 1 of 5)”**.



dsPICDEM™ 1.1 PLUS DEVELOPMENT BOARD USER'S GUIDE

Appendix A. Hardware Drawings and Schematics

A.1 INTRODUCTION

This Appendix provides a layout drawing of the printed circuit board followed by schematics for the dsPICDEM™ 1.1 Plus Development Board.

A.2 HIGHLIGHTS

- dsPICDEM™ 1.1 Plus Development Board Layout
- dsPICDEM™ 1.1 Plus Development Board Schematics

dsPICDEM™ 1.1 Plus Development Board User's Guide

FIGURE A-1: dsPICDEM™ 1.1 PLUS DEVELOPMENT BOARD LAYOUT

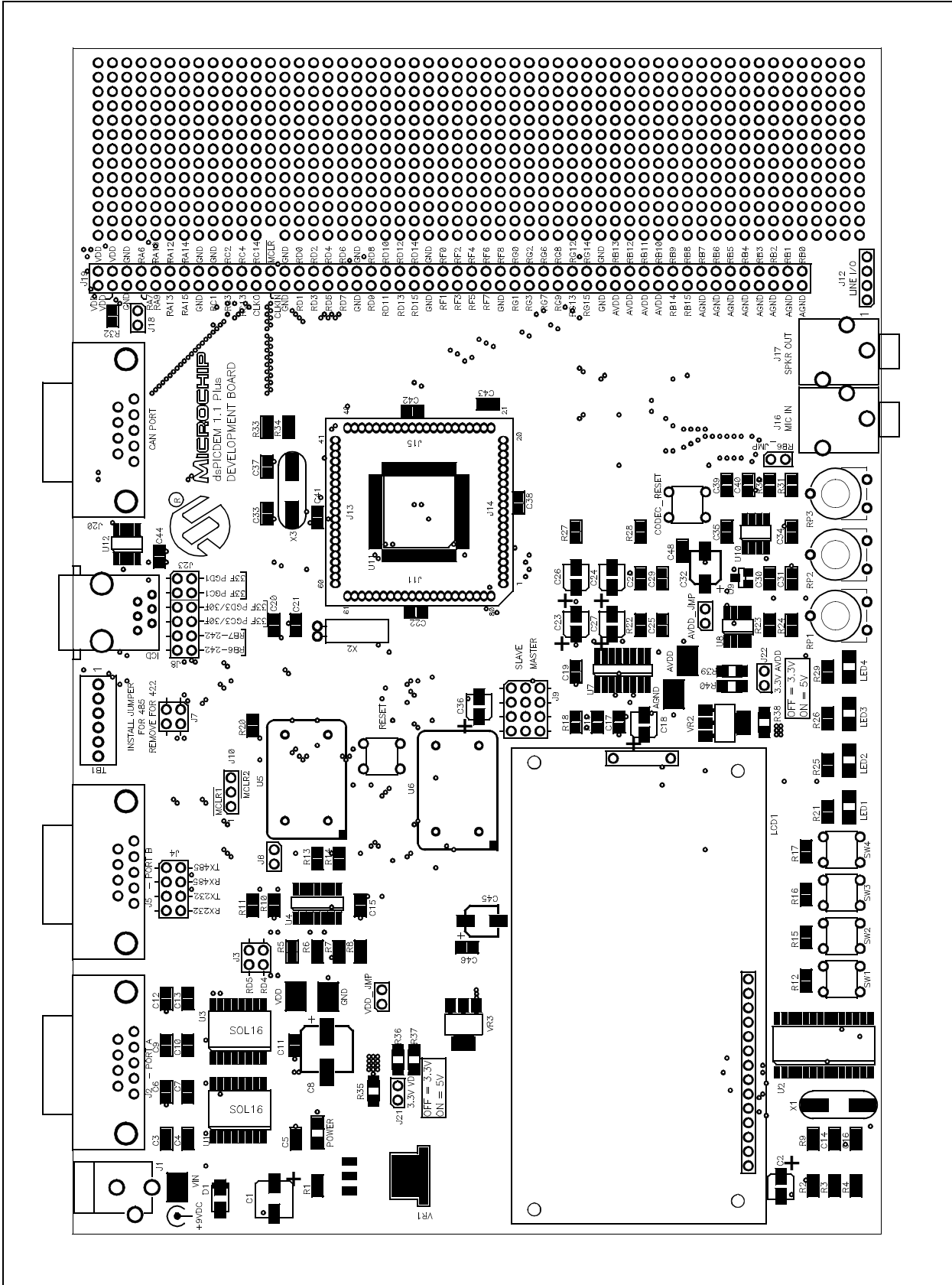

Hardware Drawings and Schematics

FIGURE A-2: dsPICDEM™ 1.1 PLUS DEVELOPMENT BOARD SCHEMATIC (SHEET 1 OF 5)

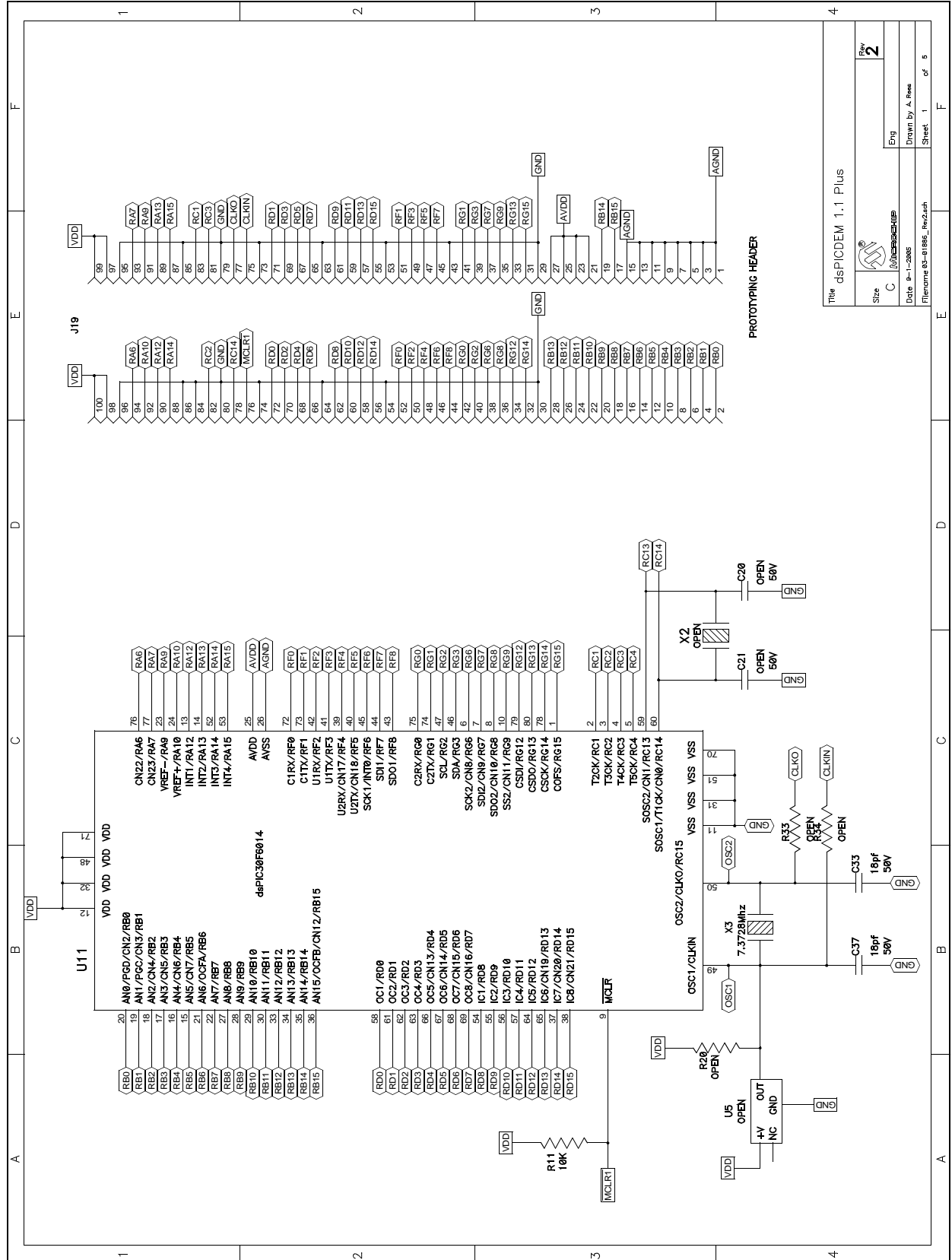

dsPICDEM™ 1.1 Plus Development Board User's Guide

FIGURE A-3: dsPICDEM™ 1.1 PLUS DEVELOPMENT BOARD SCHEMATIC (SHEET 2 OF 5)

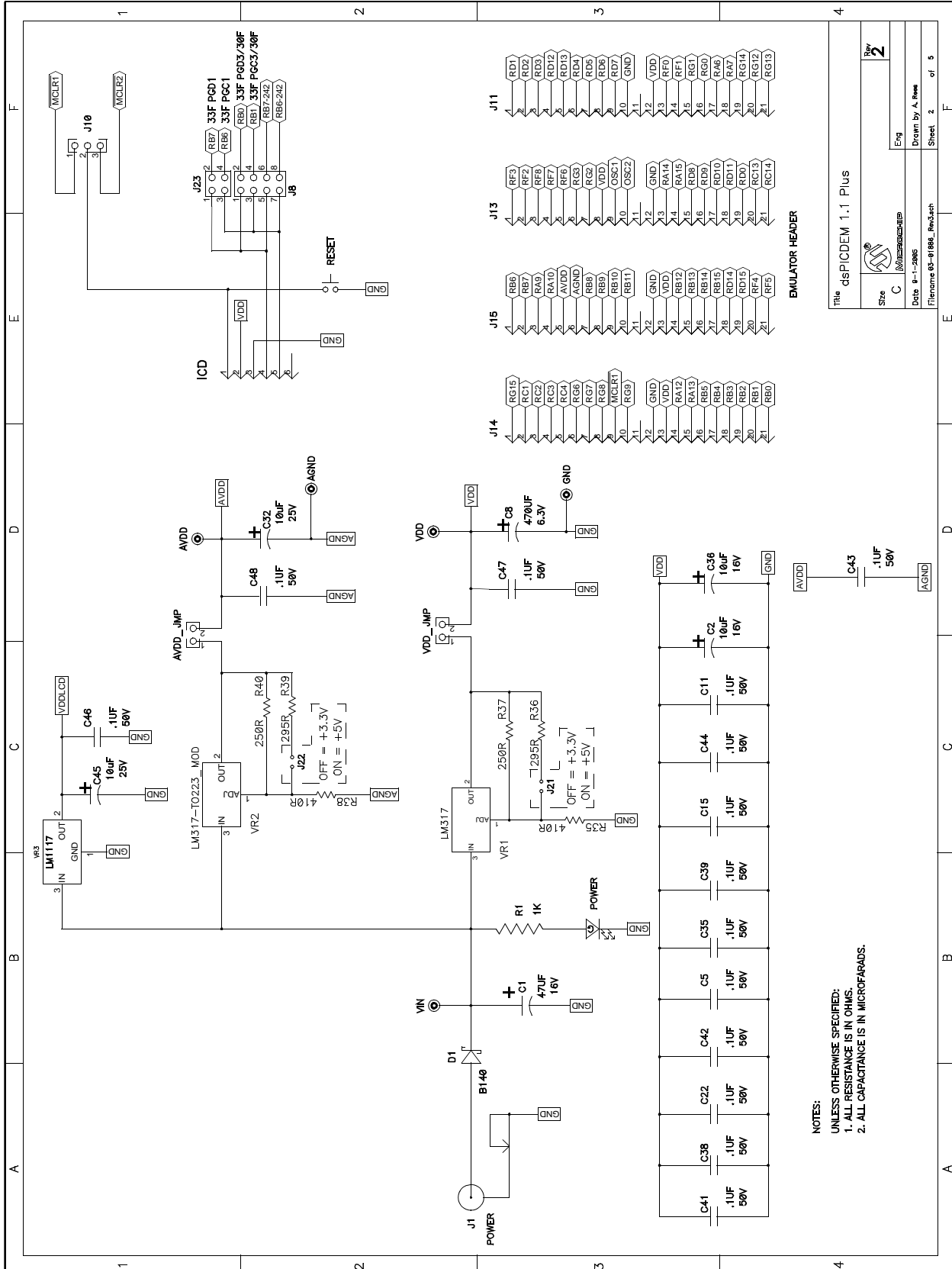

Hardware Drawings and Schematics

FIGURE A-4: dsPICDEM™ 1.1 PLUS DEVELOPMENT BOARD SCHEMATIC (SHEET 3 OF 5)

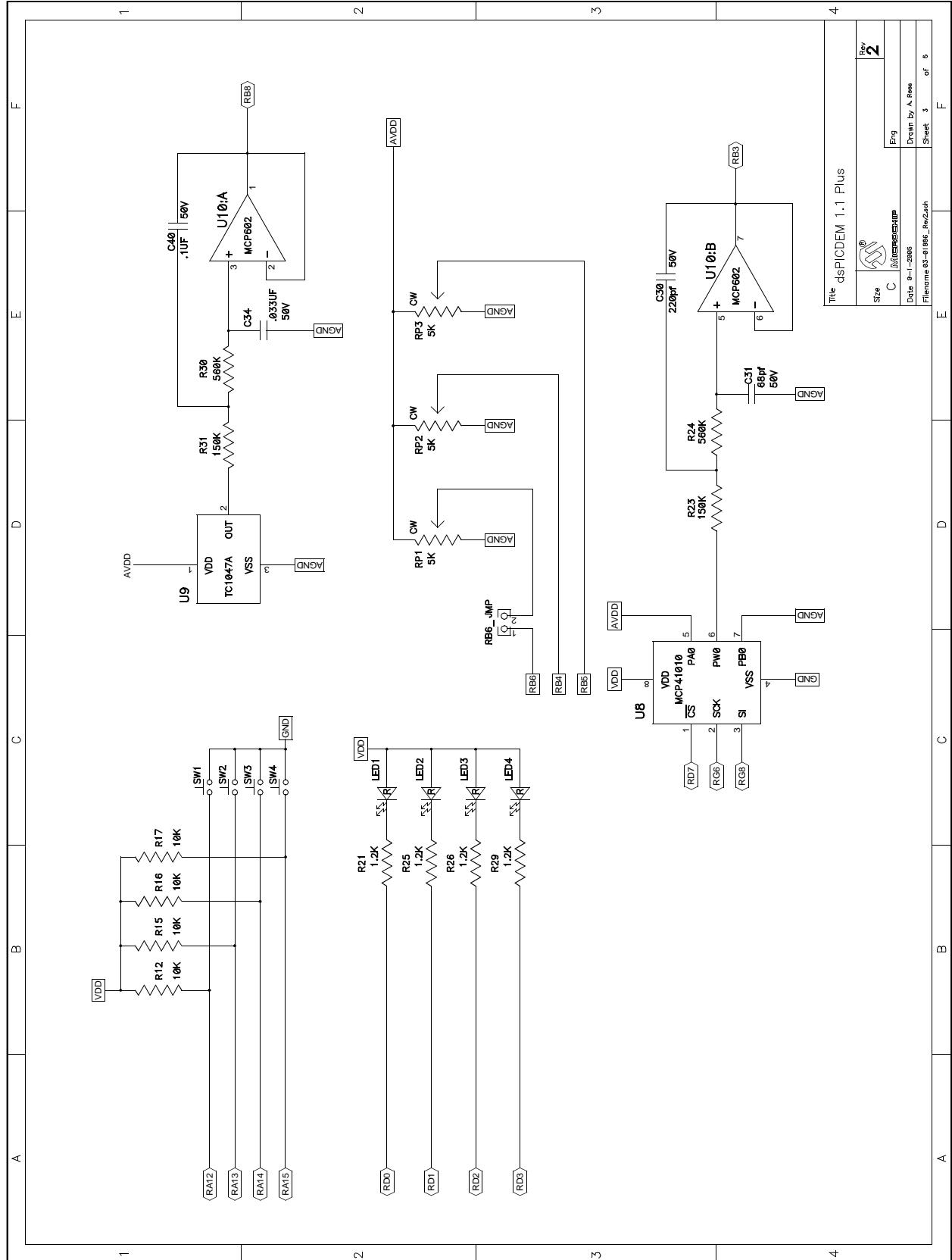

Title		dsPICDEM 1.1 Plus	
Size	C	Rev	2
Date	3-1-2005	Drawn By	A. Resa
Filename	03-0186_Rev2.sch	Sheet	3 of 5

dsPICDEM™ 1.1 Plus Development Board User's Guide

FIGURE A-5: dsPICDEM™ 1.1 PLUS DEVELOPMENT BOARD SCHEMATIC (SHEET 4 OF 5)

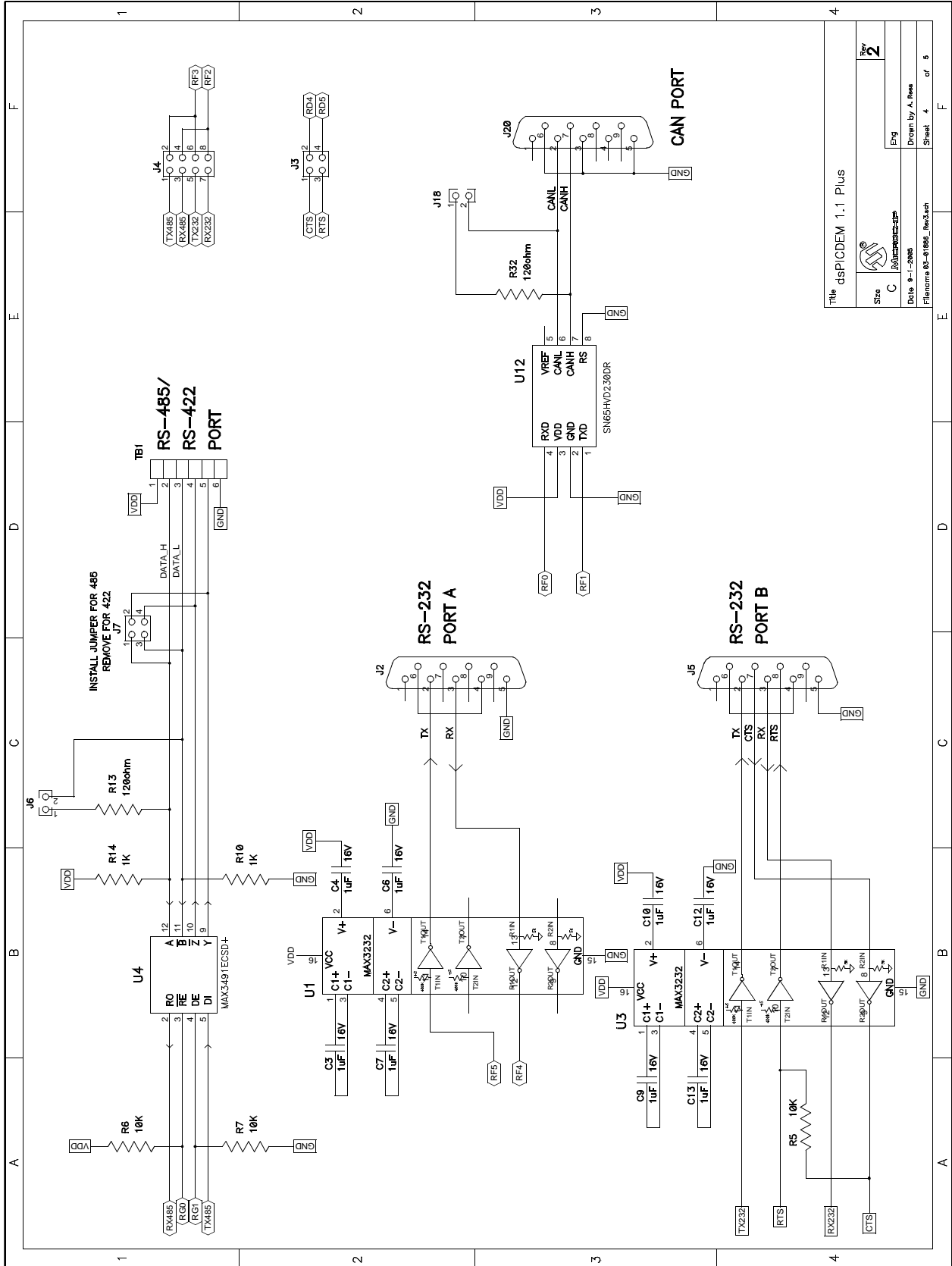

Hardware Drawings and Schematics

FIGURE A-6: dsPICDEM™ 1.1 PLUS DEVELOPMENT BOARD SCHEMATIC (SHEET 5 OF 5)

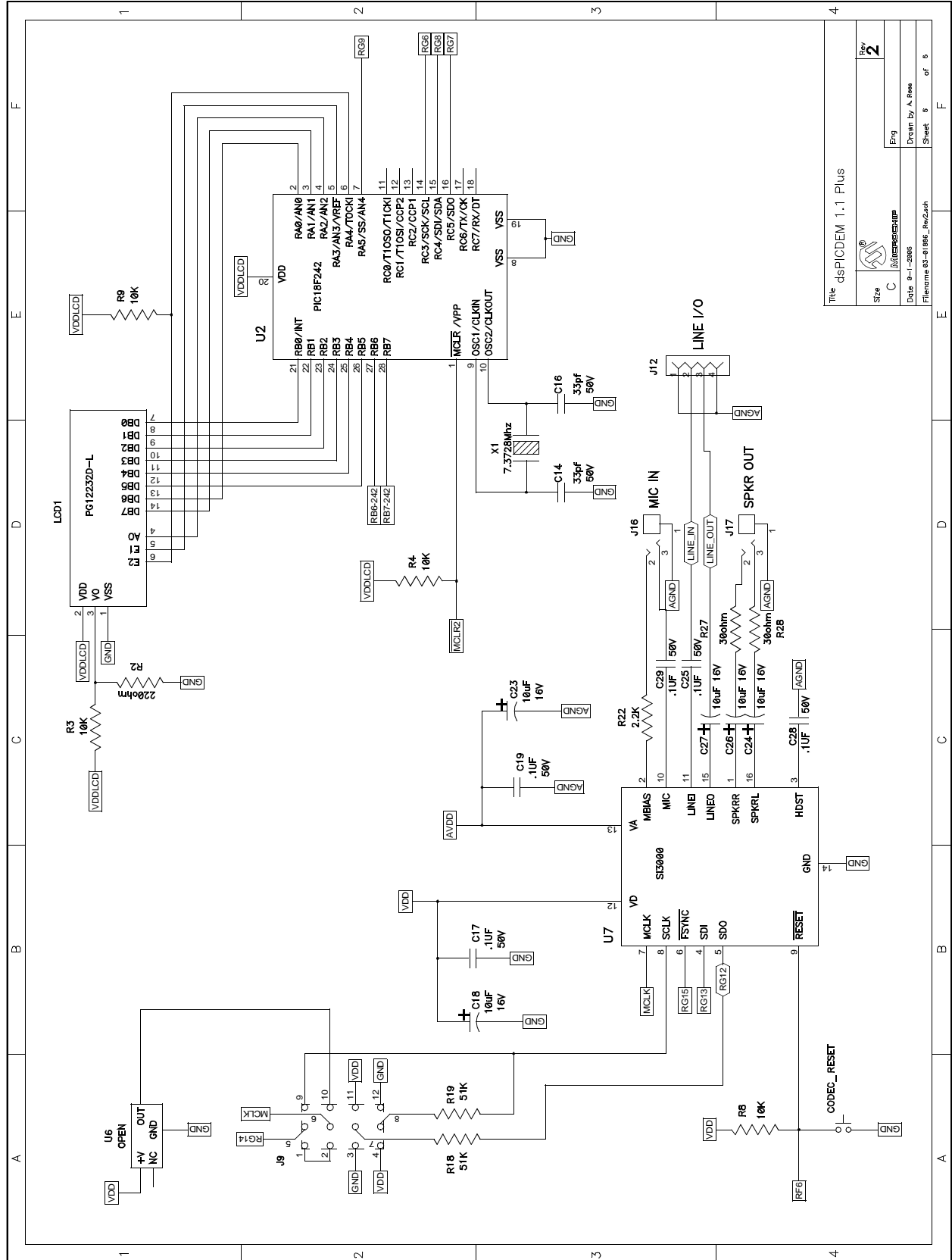

Title	dsPICDEM 1.1 Plus
Size	C
Date	9-1-2005
Filename	63-0186_Rev2.sch
Rev	2
Eng	Eng
Drawn By	A. Res
Sheet	5 of 5

dsPICDEM™ 1.1 Plus Development Board User's Guide

NOTES:

Appendix B. LCD Controller Specification

B.1 OVERVIEW

The LCD display on the dsPICDEM™ 1.1 Plus Development Board is a PG12232D-L 8-bit 122 x 32 dot-matrix LCD controlled by a PIC18F242 LCD controller with a custom driver that supports a rich set of character and graphic commands. The 122 x 32 LCD supports a standard SED1520 type controller, which is interfaced to the PIC18F242 over a parallel interface bus. A full set of ASCII characters are available for display on a 4 x 20 character grid. In Graphics mode, individual pixels and bit patterns are supported. A line drawing facility is supported as part of the basic command set.

B.2 LCD CONTROLLER INTERFACE

The LCD controller (PIC18F242) is controlled via its Serial Peripheral Interface (SPI) port. The LCD controller operates as a slave SPI with a maximum SPI clock of 2.4 MHz. Using the standard PIC® MCU nomenclature, the LCD controller is set up as a slave under Slave Select (SS) control with CKP = 0 and CKE = 0.

The dsPIC DSC SPI peripheral should be configured for:

- SMP = 0
- CKE = 0
- CKP = 0
- MODE16 = 0 and MSTEN = 1

The SPI master clock should not exceed 2.4 MHz. The SS control line should be used to synchronize the interface at the byte level.

On power-up, the LCD controller requires approximately 100 mS to initialize its internal buffers and clear the LCD display. It will not accept any input until it has completed its initialization sequence.

The controller stores incoming bytes in an interrupt buffer that is 186 bytes deep so that the dsPIC DSC device should not be able, under reasonable operation, to overrun the controller with input data. The buffer is large enough to hold a complete screen of characters plus several additional commands. The only way to overrun the buffer is to continuously send commands at a bit rate that is close to the maximum so that the LCD controller is completely occupied with receiving and storing the incoming commands and does not have sufficient extra time to process the commands. With SPI communications, the dsPIC DSC device gets a return byte with every byte sent to the controller. The controller provides the current buffer count as the return byte for each byte sent. The return byte enables the dsPIC DSC device to determine how many unprocessed bytes are in the controller's buffer after the previous byte was received by the controller. This number can never be less than the size of the proceeding command sent since the controller will not remove a command from its receive buffer until the entire command is received. This feature could be used for flow control by the dsPIC DSC device, but given the speed of the controller and the size of the interrupt buffer, it is unlikely the dsPIC DSC device could overflow the controller's buffer under normal usage. Thus, implementing flow control on the dsPIC DSC device in all but the most unusual circumstances would be an unnecessary complication.

B.3 COMMANDS

B.3.1 Command Structure

All commands recognized by the LCD controller are one to three bytes in length.

The command structure is designed to follow a simple rule that allows the interface to be self-synchronizing at the command level (i.e., if a command is corrupted for some reason, the controller can resynchronize on the command stream without special error recovery procedures). The rule is that the first byte of a command always has its MSB = 1 and the remaining bytes of the command have their MSB = 0. There is an exception to the rule that MSB = 0 for all bytes except the first byte. Some of the column commands can have data in the MSB of their second byte and thus, may violate this rule. The processing code in the LCD controller will parse these special commands and allow the command exception.

All commands follow the form of a leading identification byte followed by zero to three data bytes. The data bytes are not condensed or combined with other data, or modified from the native form of the data. There is no handshaking or flow control required because of the speed and buffer depth of the controller. This greatly simplifies the interface on the dsPIC DSC side since there is little advantage to putting wrappers around the individual commands. Nothing needs to be done to the data other than to send it.

B.3.2 Command Types

The LCD has three data types, each based on its own independent coordinate systems. The data types are:

- Character
- Pixel
- Column

Associated with each coordinate system is a "current" position of which each is independent of the other. These positions are:

- CharPos
- PixPos
- ColPos

B.3.2.1 CHARACTERS

The character commands are used to write characters to the display. The character coordinates are based on a 5 x 7 dot font justified to the upper left corner of the 6 x 8 box. The character cursor is a 5-pixel wide horizontal line that is justified to the lower left corner of the 6 x 8 box and can be turned on or off, or can be set to blink.

Character operators are based on character coordinates R and C (i.e., Row and Column). The current position, *CharPos*, specifies both the location of the character cursor and the default position that the next character command will use. The home position is the top left of the LCD display, *ChrPos* = (0,0).

The LCD accommodates four character rows (0-3) and 20 character columns (0-19). Unless otherwise specified, incrementing *ChrPosC* beyond column 19 will wrap to the next row (i.e., *ChrPosC* = 0 and *ChrPosR* + 1). If *ChrPosR* exceeds 3, it will wrap to row 0.

B.3.2.2 PIXELS

The pixel commands give the user control over individual pixels. Pixel coordinates (X,Y) have their origin at the lower left of the LCD display. The coordinate range is X: 0-121 and Y: 0-31. The PixPos (X,Y) specifies the default location for pixel commands. The home position is the bottom left of the LCD display, PixPos = (0,0).

B.3.2.3 COLUMNS

The column commands are used to write bitmaps to the display. A column is a vertical column of 8 pixels that spans the height of one of the character rows. Column coordinates (X,R) have their origin at the upper left corner of the LCD.

The X is defined the same as the pixel coordinates and the R is defined the same as the character coordinates. The coordinate range is X: 0->121 and R: 0->3. The ColPos (X,R) specifies the default location for column commands. The home position is the top left of the LCD display, ColPos = (0,0).

Unless otherwise specified, incrementing ColPosX past 121 will wrap to the next line (i.e., ColPosX = 0 and ColPosY + 1). If ColPosY exceeds 31, it will wrap to line 0.

B.3.3 Power-up Defaults

Upon a device Reset, the following LCD controller conditions are valid:

- Character cursor off
- All coordinate variables are set to their home values:
 - ChrPosC = 0, ChrPosR = 0
 - PixPosX = 0, PixPosY = 0
 - ColPosX = 0, ColPosR = 0
 - ScrollY = 0

B.3.4 Command Description

A basic command format is implemented on the PIC18F242. In general, communicating with the PIC18F242 LCD controller requires adherence to this protocol:

- Command name: Description
- Cmd: Opcode value
- Data: Number of data bytes
 - [7 6 5 4 3 2 1 0] Command dependent data
 - [7 6 5 4 3 2 1 0] Command dependent data
 - [7 6 5 4 3 2 1 0] Command dependent data

dsPICDEM™ 1.1 Plus Development Board User's Guide

B.4 GENERAL COMMANDS

B.4.1 Reset Command

The Reset command resets the LCD display and PIC18F242 to their power-up state.

Field	Form	Value
Opcode		0x80
Data	None	None

B.4.2 Home Command

The Home command sets all coordinate variables to their home values and leaves the display unchanged.

Field	Form	Value
Opcode		0x81
Data	None	None

B.4.3 HomeClear Command

The HomeClear command clears the entire display and then sets all coordinate variables to their home values.

Field	Form	Value
Opcode		0x82
Data	None	None

B.4.4 Scroll Command

The Scroll command rolls the display in the vertical axis by the amount ScrollY. The LCD data array consists of 32 lines of 122 pixels each. If scrolling, value ScrollY is set to zero and the top row of the data array is displayed on the top row of the display.

Field	Form	Value
Opcode		0xA3
Data	0 0 0 Y4 Y3 Y2 Y1 Y0	0-31

Note: The Scroll command has no effect on the various coordinate systems. It only changes the mapping of the data to the display (e.g., the top character row would be rolled to the bottom row of the display surface if ScrollY = 8 but its location in the data array is still at 0).

B.5 CHARACTER COMMANDS

The character commands treat the display like a 20-column, 4-row character display where the characters occupy 6 x 8 pixel elements. Note that there are 20 character locations on a row, each 6 pixels wide. This current implementation only uses 120 pixels of the 122-pixel wide display. The spare two-pixel columns are on the right of the display and cannot be affected by the character commands. The controller has a fixed space 5 x 7 font set for the printable ASCII characters in range: 0x20 -> 0x7E. The controller also recognizes three special characters that do not affect the display.

Note: The ChrPos increment after writing is suppressed for the special characters.

1. CR: (0x0D) Increments ChrPosR.
2. LF: (0x0A) Sets ChrPosC = 0 and increments ChrPosR.
3. BS: (0x08) Decrements ChrPosC if ChrPosC > 0; it is non-destructive

B.5.1 ChrPos Command

The ChrPos command sets the character position to ChrPosC, ChrPosR. This command has no effect on the display except for moving character cursor if it is turned on.

Field	Form	Value
Opcode		0xC5
ChrPosC	0 0 0 C4 C3 C2 C1 C0	Column 0-19
ChrPosR	0 0 0 0 0 0 R1 R2	Row 0-3

B.5.2 ChrPosInc Command

The ChrPosInc command increments the character position. This command has no effect on the display except for moving the character cursor if it is turned on.

Field	Form	Value
Opcode		0x8E
Data	None	None

B.5.3 WrtChr Command

The WrtChr command sets ChrPos to (ChrPosC,ChrPosR), then writes ASCII character to ChrPos.

Field	Form	Value
Opcode		0xE6
Data	0 A6 A5 A4 A3 A2 A1 A0	ASCII character
ChrPosC	0 0 0 C4 C3 C2 C1 C0	Column 0-19
ChrPosR	0 0 0 0 0 0 R1 R0	Row 0-3

B.5.4 WrtChrInc Command

The WrtChrInc command sets ChrPos to (ChrPosC,ChrPosR), writes an ASCII character to ChrPos, and then increments ChrPos.

Field	Form	Value
Opcode		0xE7
Data	0 A6 A5 A4 A3 A2 A1 A0	ASCII character
ChrPosC	0 0 0 C4 C3 C2 C1 C0	Column 0-19
ChrPosR	0 0 0 0 0 0 R1 R0	Row 0-3

B.5.5 WrtChrNext Command

The WrtChrNext command writes an ASCII character to the current ChrPos, then increments ChrPos.

Field	Form	Value
Opcode		0xA8
Data	0 A6 A5 A4 A3 A2 A1 A0	ASCII character

B.5.6 ChrClearRow Command

The ChrClearRow command clears the entire row ChrPosR and leaves ChrPosC = 0.

Field	Form	Value
Opcode		0xA9
ChrPosR	0 0 0 0 0 0 R1 R0	Row 0-3

B.5.7 ChrClearEOL Command

The ChrClearEOL command clears row ChrPosR from the current location to the end of the line and leaves ChrPos unchanged.

Field	Form	Value
Opcode		0x8A
Data	None	None

B.5.8 ChrCursorOff Command

The ChrCursorOff command turns off the character cursor.

Field	Form	Value
Opcode		0x8B
Data	None	None

B.5.9 ChrCursorOn Command

The ChrCursorOn command turns on the character cursor at the current ChrPos.

Field	Form	Value
Opcode		0x8C
Data	None	None

B.5.10 ChrCursorBlink Command

The ChrCursorBlink command controls cursor blinking. If the time is set to zero, the cursor will not blink, else the cursor blinks with equal on and off times, with the on time being given by the blink time.

Field	Form	Value
Opcode		0xAD
Blink Time	0 0 0 0 0 T2 T1 T0	(0-7) x 0.125 seconds

B.6 PIXEL COMMANDS

The pixel commands treat the display like a 122-column, 32-line set of pixels, which is the native resolution of the display. The pixel coordinate system differs from the others in having its origin at the lower left instead of at the upper left. Pixel coordinates are intended for graphs rather than letters or bitmap pictures.

B.6.1 PixPos Command

The PixPos command sets PixPos to (PixPosX,PixPosY) and leaves the display unchanged. This command is intended to be used in conjunction with the PixLine command.

Field	Form	Value
Opcode		0xD7
PixPosX	0 X6 X5 X4 X3 X2 X1 X0	Column 0-121
PixPosY	0 0 0 Y4 Y3 Y2 Y1 Y0	Line 0-31

B.6.2 PixOn Command

The PixOn command sets PixPos to (PixPosX,PixPosY) and turns on the pixel at that location. This command does not increment PixPos.

Field	Form	Value
Opcode		0xD8
PixPosX	0 X6 X5 X4 X3 X2 X1 X0	Column 0-121
PixPosY	0 0 0 Y4 Y3 Y2 Y1 Y0	Line 0-31

B.6.3 PixOff Command

The PixOff command sets PixPos to (PixPosX,PixPosY) and turns off the pixel at that location. This command does not increment PixPos.

Field	Form	Value
Opcode		0xD9
PixPosX	0 X6 X5 X4 X3 X2 X1 X0	Column 0-121
PixPosY	0 0 0 Y4 Y3 Y2 Y1 Y0	Line 0-31

B.6.4 PixLine Command

The PixLine command draws a straight line from the current PixPos to the specified location and leaves PixPos set to the new location.

Field	Form	Value
Opcode		0xDA
PixPosX	0 X6 X5 X4 X3 X2 X1 X0	Column 0-121
PixPosY	0 0 0 Y4 Y3 Y2 Y1 Y0	Line 0-31

dsPICDEM™ 1.1 Plus Development Board User's Guide

B.7 COLUMN COMMANDS

The column commands treat the display like a 122-column, 4-row set of 8-pixel high, 1-pixel wide display elements. The Least Significant bit of the column data byte is closest to the top of the display. The column rows are the same as the character rows but the horizontal axis is addressable to the pixel.

B.7.1 ColPos Command

The ColPos command sets ColPos to (ColPosX,ColPosR).

Field	Form	Value
Opcode		0xDB
ColPosX	0 X6 X5 X4 X3 X2 X1 X0	Column 0-121
ColPosR	0 0 0 0 0 0 R1 R0	Row 0-3

B.7.2 WrtColNext Command

The WrtColNext command writes column data to the current ColPos and then increments ColPos.

Field	Form	Value
Opcode		0xBC
Column Data	D7 D6 D5 D4 D3 D2 D1 D0	Data

B.7.3 WrtColNextOR Command

The WrtColNextOR command ORs column data with existing data and writes the result to the current ColPos, then increments ColPos.

Field	Form	Value
Opcode		0xBD
Column Data	D7 D6 D5 D4 D3 D2 D1 D0	Data

B.7.4 WrtColNextAND Command

The WrtColNextAND command ANDs column data with existing data and writes the result to the current ColPos, then increments ColPos.

Field	Form	Value
Opcode		0xBE
Column Data	D7 D6 D5 D4 D3 D2 D1 D0	Data

B.7.5 WrtColNextXOR Command

The WrtColNextXOR command XORs column data with existing data and writes the result to the current ColPos, then increments ColPos.

Field	Form	Value
Opcode		0xBF
Column Data	D7 D6 D5 D4 D3 D2 D1 D0	Data

B.8 EXAMPLES

EXAMPLE B-1: WRITE A WORD

This example clears the display and writes “Hi” starting at row 2, column 10. Write the following bytes to the SPI port:

```
0x82          // Clear screen
0xE7, 'H', 10, 2 // Write 'H' to column 10, row 2, then increment the column
0xA8, 'i'      // Write 'i' at column 11, row 2 then increment the column
```

EXAMPLE B-2: DRAW A STRAIGHT LINE

This example draws a straight line from X location (1,1) to Y location (119,3). Write the following bytes to SPI port:

```
0xD7, 1, 1 // Set Pixel cursor to X=1, Y=1
0xDA, 119, 31 // Draw line to X=119, Y=31
```

EXAMPLE B-3: DRAW AN ICON

This example draws an icon 8 pixels tall and 3 pixels wide that looks like a ‘T’ on row = 1, column = 19. Write the following bytes to SPI port:

```
0xDB, 19, 1 // Set Column cursor to X=19, Row = 1
0xBC, 0x01 // Write pixel at top of display at column 19, increment column
0xBC, 0xFF // Write vertical line at column 20, increment column
0xBC, 0x01 // Write pixel at top of display at column 21, increment column
```

dsPICDEM™ 1.1 Plus Development Board User's Guide

NOTES:

Index

A

Analog Features.....	11
Analog Potentiometers.....	61, 63
Assembler Include Path	20
AVDD Regulator.....	61

B

Breakpoint.....	28, 58
Build Options.....	20, 49
Build Project.....	21, 50
Building the Code.....	19, 49

C

CAN Port.....	61, 62
Canned Crystal Socket	61
Code Debugging	25, 55
Codec Reset Switch.....	61
Commands	
Description.....	77
Examples	83
General	78
Power-up Defaults	77
Structure	76
Types	76
Constants	
__SPLIM_init	26
Creating the Project	14, 44
Customer Notification Service.....	6
Customer Support.....	7

D

Data Acquisition Demo Display.....	30
Data Acquisition Demo Program.....	30
Data Acquisition Display	30
Data and Control Flow	36
Power-up Peripheral Initialization	36
Demo Main Menu.....	29
Demo Menu Options	30
Demonstration Code Module Summary.....	29
Demonstration Performance Metrics.....	39
Summary with FIR Filter	40
Summary with IIR Filter.....	41
Demonstration Program	
Data Acquisition Display	30
DSP Operations Display	32
DTMF Tone Generation.....	34
Summary	29
Demonstration Programs	12

Development Board

Features

Analog.....	11
Device Clocking.....	11
ICD 2 and ICE 4000 Connections.....	10
Miscellaneous	11
Power Supply Circuit	10
Serial Communication Channels	10
Voice band Codec	11

Photograph

Development Board Features	9
Development Board Features	10
Device Clocking Features	11
Device Selection, for Project.....	14, 44
Digital Potentiometer.....	64
Documentation	
Conventions	3
DSP Operations Demo Display	32
DSP Operations Flow Diagram	33
DTMF Tone Generation Controls.....	34
DTMF Tone Generation Demo.....	34

E

Emulation Headers.....	61, 65
------------------------	--------

F

Free Software Foundation.....	4
-------------------------------	---

G

GNU Language Tools	4
--------------------------	---

H

Hardware Components

Analog Potentiometers.....	61, 63
AVDD Regulator	61
CAN Port.....	61, 62
Canned Crystal Socket	61
Codec Reset Switch.....	61
Digital Potentiometer.....	64
Emulation Headers	61, 65
ICD Connector	61, 64
LCD Graphic Display	61, 64
LEDs	61, 63
Oscillator Options.....	65
Oscillator X2.....	61
Oscillator X3.....	61
Phono Jacks	61
Plug-in Module.....	62
Power Supply.....	65
Power-on Indicator.....	65
Power-on LED.....	61
Prototyping Area	61, 66
Push Button Switches	61, 63

dsPICDEM™ 1.1 Plus Development Board User's Guide

Reset Switch	61, 66
RS-232 Serial Ports	61, 62
RS-422 Port	61, 63
RS-485 Port	61, 63
Sample Devices	66
Si3000 Codec	61
Si3000 External Clock Socket.....	61
Si3000 Voice Band Codec	64
Temperature Sensor	61, 63
VDD Regulator	61

I

ICD Connector	61, 64
Internet Address	6
Interrupts	38
DCI	38
DTMF	38
External	38
LCD Controller	38
SPI	38
Timer 1	39
Timer 2	39
UART Receive	38
UART Transmit	38

K

Kit Contents.....	9
-------------------	---

L

Language Toolsuite Selection, for Project.....	15, 45
LCD Controller Interface.....	75
Character Commands	79
Column Commands	82
Commands.....	76
Pixel Commands	81
LCD Graphic Display.....	61, 64
LEDs	61, 63

M

Make Project	21, 50
Microchip Internet Web Site	6
Miscellaneous Features	11
MPLAB ASM30 Assembler	15
MPLAB ICD 2	13, 19, 20, 21, 22, 43, 49, 51, 52
MPLAB IDE	13, 14, 17, 18, 20, 23, 43, 44, 47, 48, 52
MPLAB IDE Project Wizard.....	14, 44
MPLAB IDE User's Guide	5
MPLAB LINK 30 Object Linker	15

O

Oscillator Options.....	65
Oscillator X2	61
Oscillator X3	61
Output Window.....	18, 21, 48, 50

P

Peripherals	
12-bit ADC.....	35
Data Converter Interface.....	36
Hierarchical/Prioritized Interrupt Control	36
INTx pins	36
SPI 2	35
Timer1	35
Timer2	35
Timer3	35
Timer4	35
Timer5	35
UART2 TX/RX.....	35
Phono Jacks	61
Plug-in Module	62
Photograph.....	10
Power Supply	65
Power Supply Features	10
Power-on Indicator	65
Power-on LED	61
Programming the Chip	21, 51
Project Name.....	16, 46
Project Window	18, 48
Project Wizard	14, 44
Prototyping Area.....	61, 66
Push Button Switches	61, 63

R

Reading, Recommended.....	4
Reset Switch	61, 66
RS-232 Serial Ports.....	61, 62
RS-422 Port.....	61, 63
RS-485 Port.....	61, 63

S

Sample Devices	66
Serial Communication Features	10
Si3000 Codec.....	61
Si3000 External Clock Socket.....	61
Si3000 Voice Band Codec	64
Source Code Window.....	18, 27, 48, 57

T

Temperature Sensor	61, 63
Test Code Module	42

V

VDD Regulator	61
Voice Band Codec Features	11

W

Warranty Registration.....	4
Watch Window	27, 57
WWW Address	6

NOTES:



WORLDWIDE SALES AND SERVICE

AMERICAS

Corporate Office
2355 West Chandler Blvd.
Chandler, AZ 85224-6199
Tel: 480-792-7200
Fax: 480-792-7277
Technical Support:
<http://support.microchip.com>
Web Address:
www.microchip.com

Atlanta
Alpharetta, GA
Tel: 770-640-0034
Fax: 770-640-0307

Boston
Westborough, MA
Tel: 774-760-0087
Fax: 774-760-0088

Chicago
Itasca, IL
Tel: 630-285-0071
Fax: 630-285-0075

Dallas
Addison, TX
Tel: 972-818-7423
Fax: 972-818-2924

Detroit
Farmington Hills, MI
Tel: 248-538-2250
Fax: 248-538-2260

Kokomo
Kokomo, IN
Tel: 765-864-8360
Fax: 765-864-8387

Los Angeles
Mission Viejo, CA
Tel: 949-462-9523
Fax: 949-462-9608

Santa Clara
Santa Clara, CA
Tel: 408-961-6444
Fax: 408-961-6445

Toronto
Mississauga, Ontario,
Canada
Tel: 905-673-0699
Fax: 905-673-6509

ASIA/PACIFIC

Asia Pacific Office
Suites 3707-14, 37th Floor
Tower 6, The Gateway
Harbour City, Kowloon
Hong Kong
Tel: 852-2401-1200
Fax: 852-2401-3431

Australia - Sydney
Tel: 61-2-9868-6733
Fax: 61-2-9868-6755

China - Beijing
Tel: 86-10-8528-2100
Fax: 86-10-8528-2104

China - Chengdu
Tel: 86-28-8665-5511
Fax: 86-28-8665-7889

China - Fuzhou
Tel: 86-591-8750-3506
Fax: 86-591-8750-3521

China - Hong Kong SAR
Tel: 852-2401-1200
Fax: 852-2401-3431

China - Qingdao
Tel: 86-532-8502-7355
Fax: 86-532-8502-7205

China - Shanghai
Tel: 86-21-5407-5533
Fax: 86-21-5407-5066

China - Shenyang
Tel: 86-24-2334-2829
Fax: 86-24-2334-2393

China - Shenzhen
Tel: 86-755-8203-2660
Fax: 86-755-8203-1760

China - Shunde
Tel: 86-757-2839-5507
Fax: 86-757-2839-5571

China - Wuhan
Tel: 86-27-5980-5300
Fax: 86-27-5980-5118

China - Xian
Tel: 86-29-8833-7250
Fax: 86-29-8833-7256

ASIA/PACIFIC

India - Bangalore
Tel: 91-80-4182-8400
Fax: 91-80-4182-8422

India - New Delhi
Tel: 91-11-4160-8631
Fax: 91-11-4160-8632

India - Pune
Tel: 91-20-2566-1512
Fax: 91-20-2566-1513

Japan - Yokohama
Tel: 81-45-471-6166
Fax: 81-45-471-6122

Korea - Gumi
Tel: 82-54-473-4301
Fax: 82-54-473-4302

Korea - Seoul
Tel: 82-2-554-7200
Fax: 82-2-558-5932 or
82-2-558-5934

Malaysia - Penang
Tel: 60-4-646-8870
Fax: 60-4-646-5086

Philippines - Manila
Tel: 63-2-634-9065
Fax: 63-2-634-9069

Singapore
Tel: 65-6334-8870
Fax: 65-6334-8850

Taiwan - Hsin Chu
Tel: 886-3-572-9526
Fax: 886-3-572-6459

Taiwan - Kaohsiung
Tel: 886-7-536-4818
Fax: 886-7-536-4803

Taiwan - Taipei
Tel: 886-2-2500-6610
Fax: 886-2-2508-0102

Thailand - Bangkok
Tel: 66-2-694-1351
Fax: 66-2-694-1350

EUROPE

Austria - Wels
Tel: 43-7242-2244-3910
Fax: 43-7242-2244-393

Denmark - Copenhagen
Tel: 45-4450-2828
Fax: 45-4485-2829

France - Paris
Tel: 33-1-69-53-63-20
Fax: 33-1-69-30-90-79

Germany - Munich
Tel: 49-89-627-144-0
Fax: 49-89-627-144-44

Italy - Milan
Tel: 39-0331-742611
Fax: 39-0331-466781

Netherlands - Drunen
Tel: 31-416-690399
Fax: 31-416-690340

Spain - Madrid
Tel: 34-91-708-08-90
Fax: 34-91-708-08-91

UK - Wokingham
Tel: 44-118-921-5869
Fax: 44-118-921-5820