

3 WAY MALE HOUSING ASSEMBLY  
WITHOUT XMAS TREE  
(VIEWED FROM MATE SIDE)

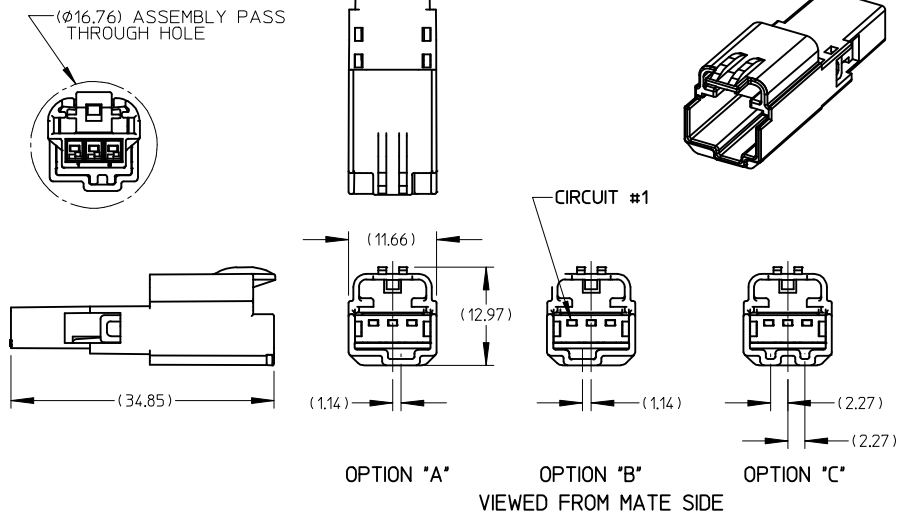

5 WAY MALE HOUSING ASSEMBLY  
WITHOUT XMAS TREE  
(VIEWED FROM MATE SIDE)

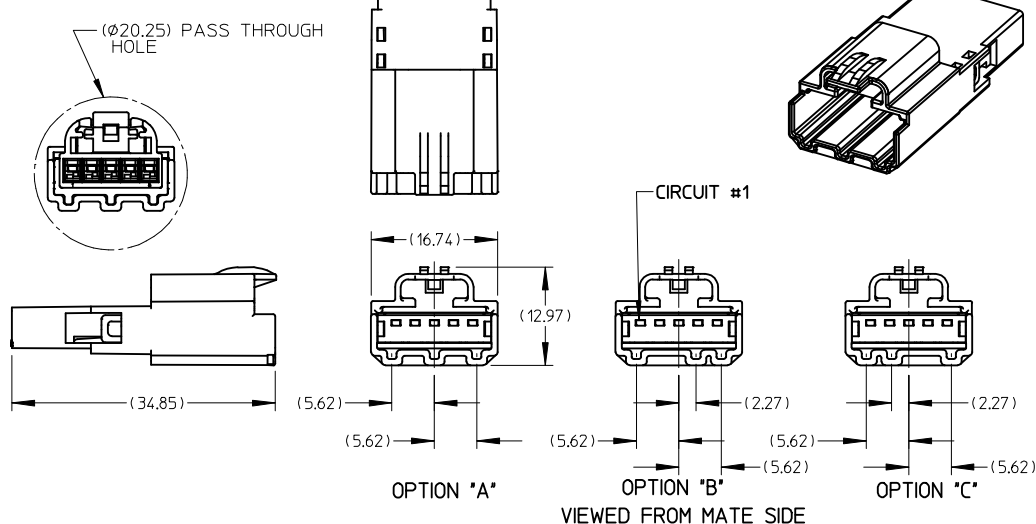

4 WAY MALE HOUSING ASSEMBLY  
WITHOUT XMAS TREE  
(VIEWED FROM MATE SIDE)

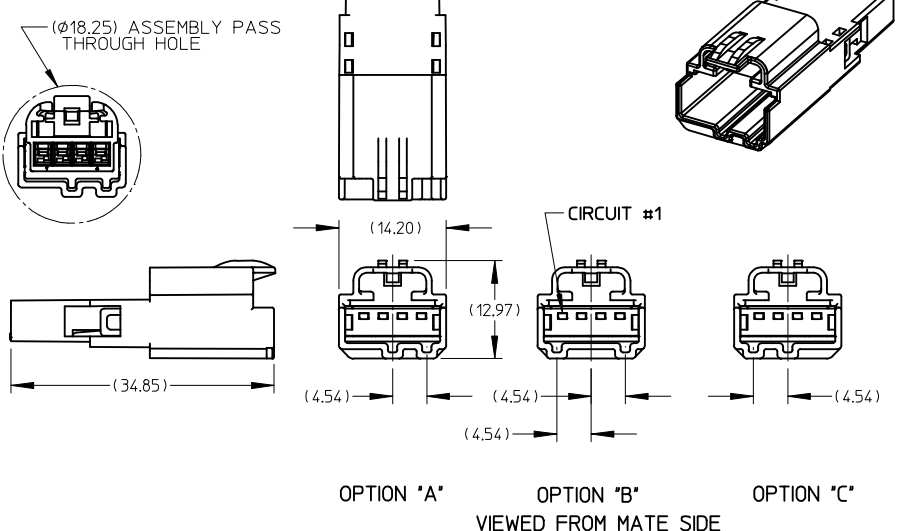

6 WAY MALE HOUSING ASSEMBLY  
WITHOUT XMAS TREE  
(VIEWED FROM MATE SIDE)

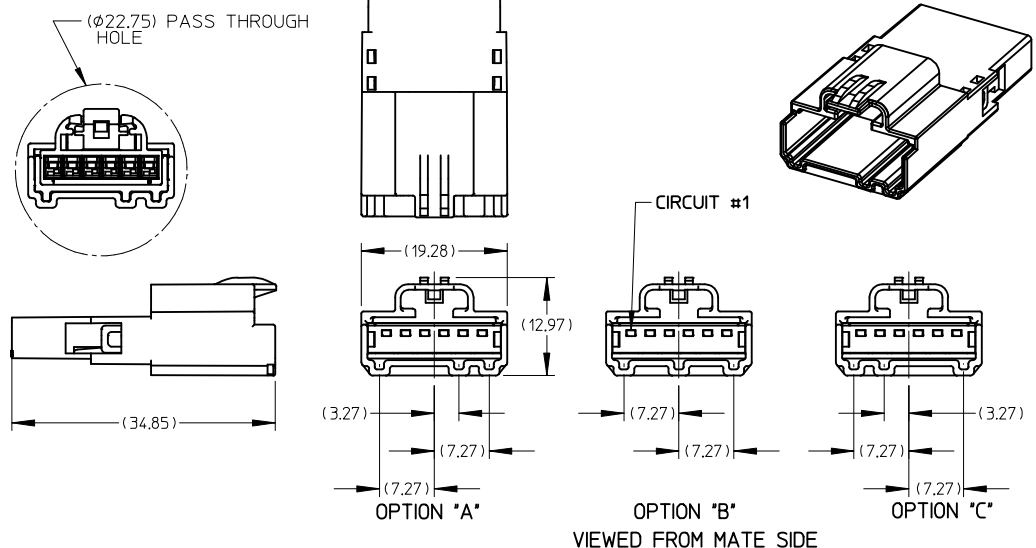

- NOTES:
1. MATERIAL: HOUSING: SPS GLASS FILLED, COLOR SEE CHART.  
TPA: PBT.
  2. PRODUCT SPECIFICATION: PS-31067-0001.
  3. PACKAGING SPECIFICATION: DRAWING PK-31301-067.
  4. MATES WITH: SEE SALES DRAWINGS SD-31109-003.

EC NO: UAU2009-1155  
DRWN: THERUF02009/05/12  
CHK: TANGELI2009/05/14  
APPR: MKNACK 2009/05/14

QUALITY SYMBOLS	DESCRIPTION
▽-0	
▽C-0	

GENERAL TOLERANCES (UNLESS SPECIFIED)	
	mm INCH
4 PLACES ±	0.25 0.010
3 PLACES ±	0.13 0.005
2 PLACES ±	0.13 0.005
1 PLACE ±	0.25 0.010
ANGULAR ± 1/2 °	
DRAFT WHERE APPLICABLE MUST REMAIN WITHIN DIMENSIONS	

SCALE 2:1	DESIGN UNITS METRIC
DIMENSION STYLE MM ONLY	
DRAWN BY	DATE
DEMOE	01/04/04
CHECKED BY	DATE
APPROVED BY	DATE

THIRD ANGLE PROJECTION

REVISE ON CAD ONLY

MALE ASSEMBLY CHARTED SALES DRAWING

**MOLEX INCORPORATED**

MATERIAL NO. SEE CHART

DOCUMENT NO. SD-31110-003

SHEET NO. 1 OF 3

THIS DRAWING CONTAINS INFORMATION THAT IS PROPRIETARY TO MOLEX INCORPORATED AND SHOULD NOT BE USED WITHOUT WRITTEN PERMISSION

3 WAY MALE HOUSING ASSEMBLY WITH XMAS TREE (VIEWED FROM MATE SIDE)

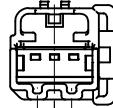
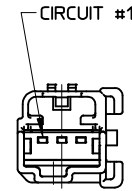
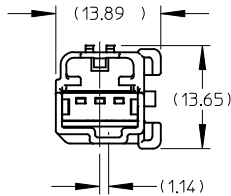
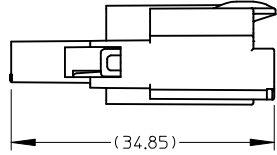
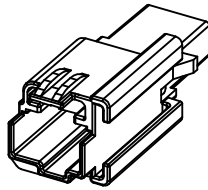
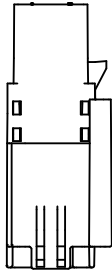

OPTION "A"

OPTION "B" VIEWED FROM MATE SIDE

OPTION "C"

5 WAY MALE HOUSING ASSEMBLY WITH XMAS TREE (VIEWED FROM MATE SIDE)

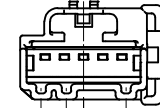
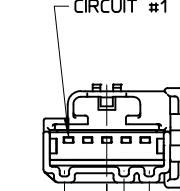
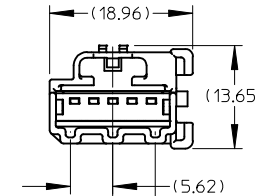
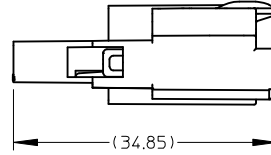
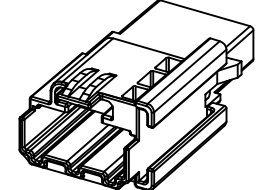
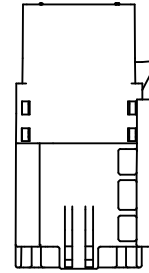

OPTION "A"

OPTION "B" VIEWED FROM MATE SIDE

OPTION "C"

4 WAY MALE HOUSING ASSEMBLY WITH XMAS TREE (VIEWED FROM MATE SIDE)

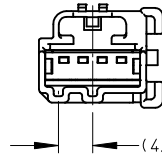
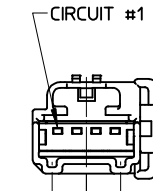
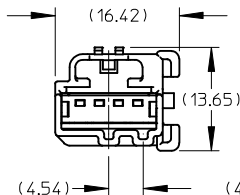
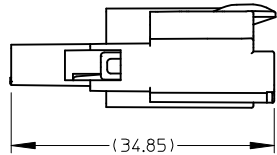
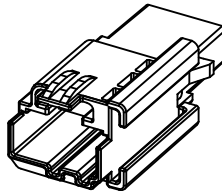
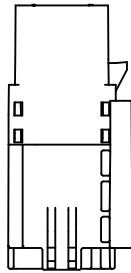

OPTION "A"

OPTION "B" VIEWED FROM MATE SIDE

OPTION "C"

6 WAY MALE HOUSING ASSEMBLY WITH XMAS TREE (VIEWED FROM MATE SIDE)

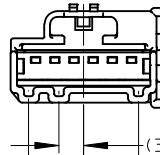
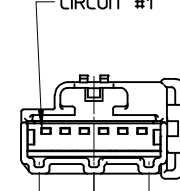
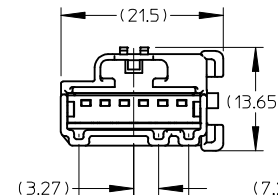
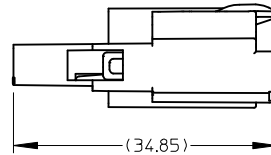
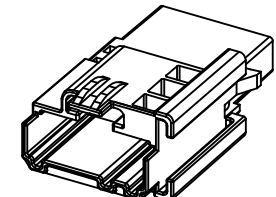
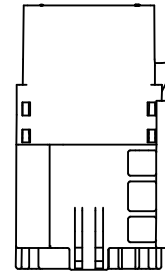

OPTION "A"

OPTION "B" VIEWED FROM MATE SIDE

OPTION "C"

EC NO: UAU2009-1155  
DRWN: THERFURT009/05/12  
CHKD: TSMITH 2009/05/14  
APPR: TANGELLO2009/05/14

QUALITY SYMBOLS	GENERAL TOLERANCES (UNLESS SPECIFIED)	
▽ = 0	mm	INCH
	4 PLACES ± ---	± ---
▽C = 0	3 PLACES ± ---	± ---
	2 PLACES ± 0.13	± ---
	1 PLACE ± 0.25	± ---
	ANGULAR ± 1/2°	

DRAFT WHERE APPLICABLE  
MUST REMAIN WITHIN DIMENSIONS

SCALE 2:1	DESIGN UNITS METRIC
DIMENSION STYLE MM ONLY	
DRAWN BY DEMEO	DATE 01/04/04
CHECKED BY	DATE
APPROVED BY	DATE

THIRD ANGLE PROJECTION	REVISE ON CAD ONLY
TITLE MALE ASSEMBLY CHARTED SALES DRAWING	
MOLEX MOLEX INCORPORATED	
MATERIAL NO. ENTER-PART	DOCUMENT NO. SD-31110-003
SHEET NO. 2 OF 3	

THIS DRAWING CONTAINS INFORMATION THAT IS PROPRIETARY TO MOLEX INCORPORATED AND SHOULD NOT BE USED WITHOUT WRITTEN PERMISSION

BILL OF MATERIALS

BILL OF MATERIALS

ASSEMBLY PART NUMBER	DESCRIPTION	XMAS TREE ATTACHMENT FEATURE	PART NUMBER	DESCRIPTION	COLOR
31067-1040	3 WAY MALE ASSEMBLY POLARIZATION "A"	NO	31112-0030	MALE HOUSING	BLACK
			31114-0030	TPA	NATURAL (WHITE)
31067-1041	3 WAY MALE ASSEMBLY POLARIZATION "B"	NO	31112-0031	MALE HOUSING	GRAY
			31114-0030	TPA	NATURAL (WHITE)
31067-1042	3 WAY MALE ASSEMBLY POLARIZATION "C"	NO	31112-0032	MALE HOUSING	BROWN
			31114-0030	TPA	NATURAL (WHITE)
31067-1070	3 WAY MALE ASSEMBLY POLARIZATION "A"	YES	31112-1030	MALE HOUSING	BLACK
			31114-0030	TPA	NATURAL (WHITE)
31067-1071	3 WAY MALE ASSEMBLY POLARIZATION "B"	YES	31112-1031	MALE HOUSING	GRAY
			31114-0030	TPA	NATURAL (WHITE)
31067-1072	3 WAY MALE ASSEMBLY POLARIZATION "C"	YES	31112-1032	MALE HOUSING	BROWN
			31114-0030	TPA	NATURAL (WHITE)
31068-1040	4 WAY MALE ASSEMBLY POLARIZATION "A"	NO	31166-0040	MALE HOUSING	BLACK
			31167-0040	TPA	NATURAL (WHITE)
31068-1041	4 WAY MALE ASSEMBLY POLARIZATION "B"	NO	31166-0031	MALE HOUSING	GRAY
			31167-0040	TPA	NATURAL (WHITE)
31068-1042	4 WAY MALE ASSEMBLY POLARIZATION "C"	NO	31166-0032	MALE HOUSING	BROWN
			31167-0040	TPA	NATURAL (WHITE)
31068-1070	4 WAY MALE ASSEMBLY POLARIZATION "A"	YES	31166-1040	MALE HOUSING	BLACK
			31167-0040	TPA	NATURAL (WHITE)
31068-1071	4 WAY MALE ASSEMBLY POLARIZATION "B"	YES	31166-1041	MALE HOUSING	GRAY
			31167-0040	TPA	NATURAL (WHITE)
31068-1072	4 WAY MALE ASSEMBLY POLARIZATION "C"	YES	31166-1042	MALE HOUSING	BROWN
			31167-0040	TPA	NATURAL (WHITE)

ASSEMBLY PART NUMBER	DESCRIPTION	XMAS TREE ATTACHMENT FEATURE	PART NUMBER	DESCRIPTION	COLOR
31072-1040	5 WAY MALE ASSEMBLY POLARIZATION "A"	NO	31169-0050	MALE HOUSING	BLACK
			31170-0050	TPA	NATURAL (WHITE)
31072-1041	5 WAY MALE ASSEMBLY POLARIZATION "B"	NO	31169-0051	MALE HOUSING	GRAY
			31170-0050	TPA	NATURAL (WHITE)
31072-1042	5 WAY MALE ASSEMBLY POLARIZATION "C"	NO	31169-0052	MALE HOUSING	BROWN
			31170-0050	TPA	NATURAL (WHITE)
31072-1070	5 WAY MALE ASSEMBLY POLARIZATION "A"	YES	31169-1050	MALE HOUSING	BLACK
			31170-0050	TPA	NATURAL (WHITE)
31072-1071	5 WAY MALE ASSEMBLY POLARIZATION "B"	YES	31169-1051	MALE HOUSING	GRAY
			31170-0050	TPA	NATURAL (WHITE)
31072-1072	5 WAY MALE ASSEMBLY POLARIZATION "C"	YES	31169-1052	MALE HOUSING	BROWN
			31170-0050	TPA	NATURAL (WHITE)
31073-1040	6 WAY MALE ASSEMBLY POLARIZATION "A"	NO	31172-0060	MALE HOUSING	BLACK
			31173-0060	TPA	NATURAL (WHITE)
31073-1041	6 WAY MALE ASSEMBLY POLARIZATION "B"	NO	31172-0061	MALE HOUSING	GRAY
			31173-0060	TPA	NATURAL (WHITE)
31073-1042	6 WAY MALE ASSEMBLY POLARIZATION "C"	NO	31172-0062	MALE HOUSING	BROWN
			31173-0060	TPA	NATURAL (WHITE)
31073-1070	6 WAY MALE ASSEMBLY POLARIZATION "A"	YES	31172-1060	MALE HOUSING	BLACK
			31173-0060	TPA	NATURAL (WHITE)
31073-1071	6 WAY MALE ASSEMBLY POLARIZATION "B"	YES	31172-1061	MALE HOUSING	GRAY
			31173-0060	TPA	NATURAL (WHITE)
31073-1072	6 WAY MALE ASSEMBLY POLARIZATION "C"	YES	31172-1062	MALE HOUSING	BROWN
			31173-0060	TPA	NATURAL (WHITE)

EC NO: UAU2009-1155 DRWN: THERFU2009/05/12 CHK: TANGELL2009/05/14 APPR: MKNACK 2009/05/14	QUALITY SYMBOLS	GENERAL TOLERANCES (UNLESS SPECIFIED)		SCALE 2:1	DESIGN UNITS METRIC	THIRD ANGLE PROJECTION	REVISE ON CAD ONLY
	▽ - 0 ▽ - 0	mm		DIMENSION STYLE MM ONLY		MALE ASSEMBLY CHARTED SALES DRAWING	
		4 PLACES ± ---	± ---	DRAWN BY DATE		DEMOE 01/04/04	
		3 PLACES ± ---	± ---	CHECKED BY DATE		MATERIAL NO. SEE CHART	
2 PLACES ± 0.13		± ---	APPROVED BY DATE		DOCUMENT NO. SD-31110-003		SHEET NO. 3 OF 3
1 PLACE ± 0.25		± ---	DRAFT WHERE APPLICABLE MUST REMAIN WITHIN DIMENSIONS		THIS DRAWING CONTAINS INFORMATION THAT IS PROPRIETARY TO MOLEX INCORPORATED AND SHOULD NOT BE USED WITHOUT WRITTEN PERMISSION		
ANGULAR ± 1/2 °							

3 WAY MALE HOUSING ASSEMBLY  
WITHOUT XMAS TREE  
(VIEWED FROM MATE SIDE)

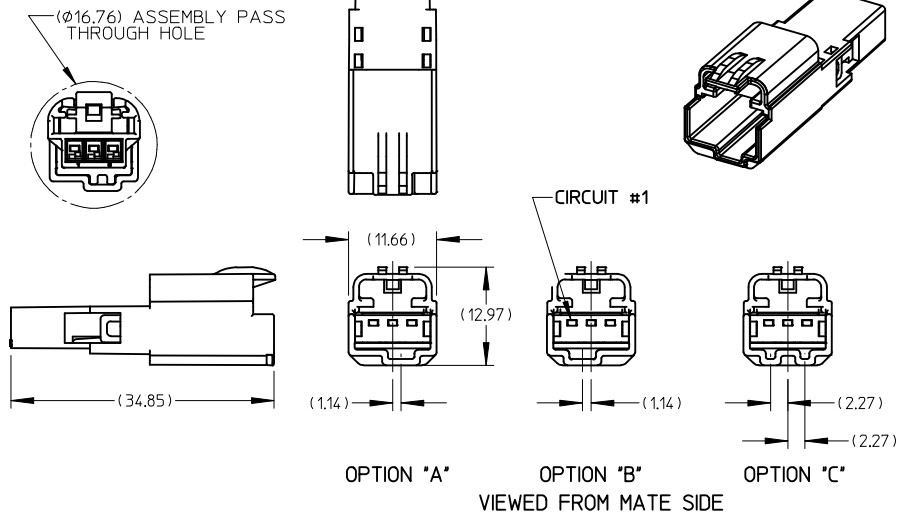

5 WAY MALE HOUSING ASSEMBLY  
WITHOUT XMAS TREE  
(VIEWED FROM MATE SIDE)

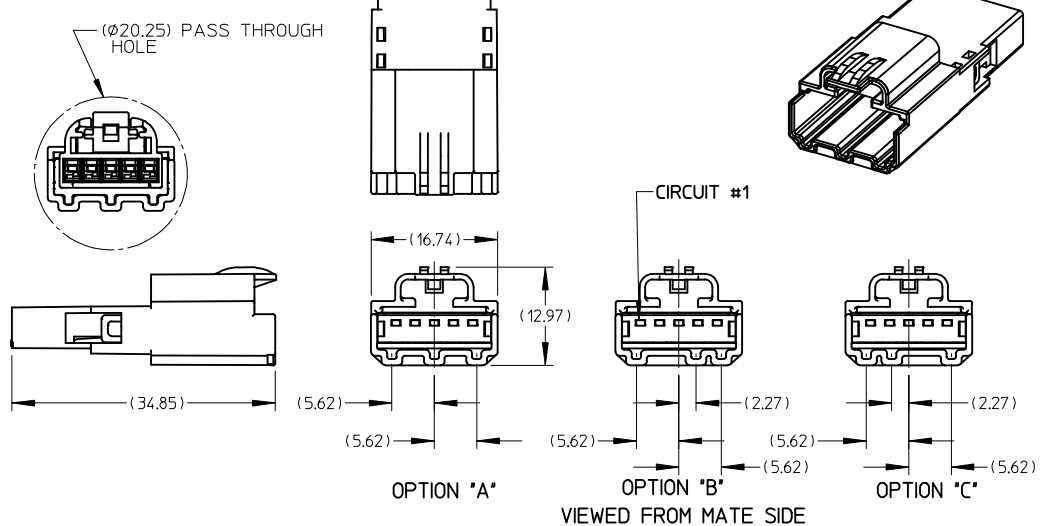

4 WAY MALE HOUSING ASSEMBLY  
WITHOUT XMAS TREE  
(VIEWED FROM MATE SIDE)

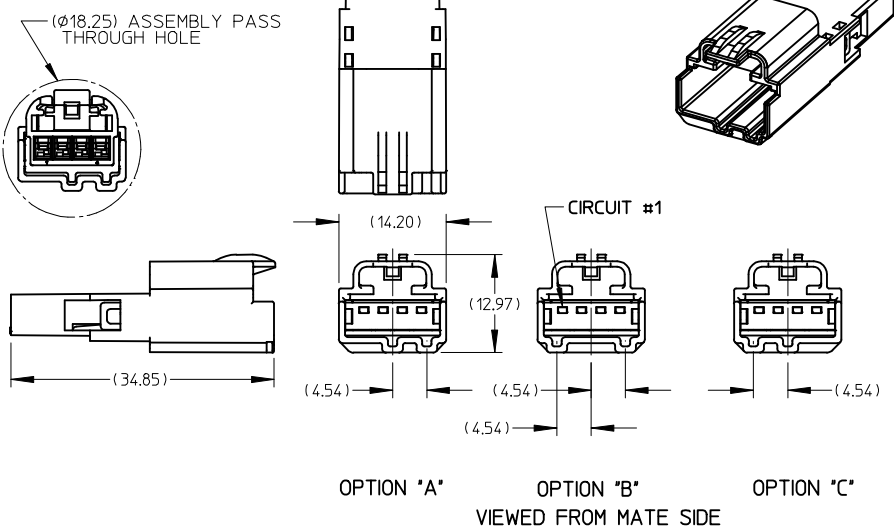

6 WAY MALE HOUSING ASSEMBLY  
WITHOUT XMAS TREE  
(VIEWED FROM MATE SIDE)

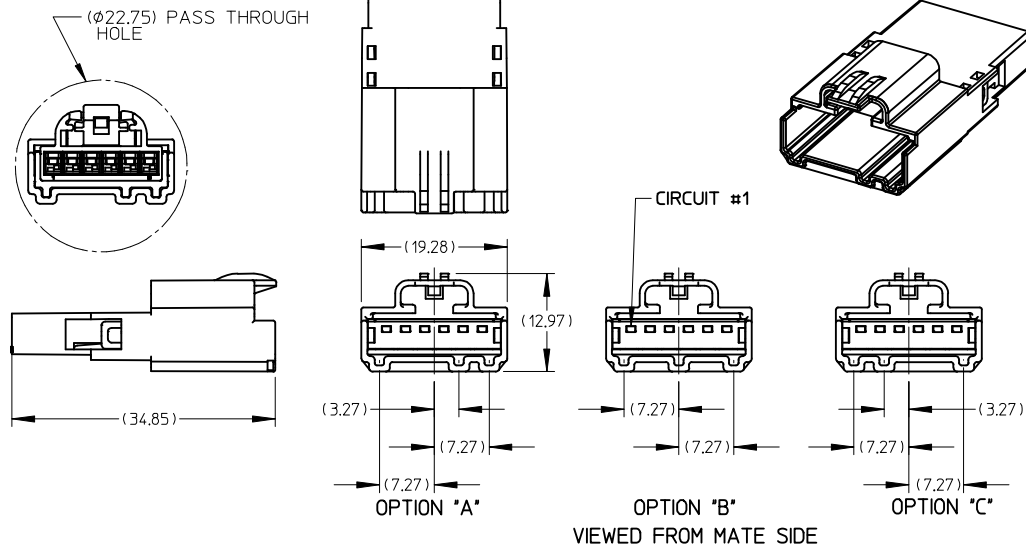

NOTES:

1. MATERIAL: HOUSING: SPS GLASS FILLED, COLOR SEE CHART.  
TPA: PBT.
2. PRODUCT SPECIFICATION: PS-31067-0001.
3. PACKAGING SPECIFICATION: DRAWING PK-31301-067.
4. MATES WITH: SEE SALES DRAWINGS SD-31109-003.

EC NO: UAU2009-1155  
DRWN: THERUF02009/05/12  
CHK: TANGELI2009/05/14  
APPR: MKNACK 2009/05/14

REV	DESCRIPTION
E1	

QUALITY SYMBOLS	GENERAL TOLERANCES (UNLESS SPECIFIED)	
	mm	INCH
▽-0	4 PLACES ± ---	± ---
	3 PLACES ± ---	± ---
	2 PLACES ± 0.13	± ---
	1 PLACE ± 0.25	± ---
∇-0	ANGULAR ± 1/2 °	

DRAFT WHERE APPLICABLE  
MUST REMAIN  
WITHIN DIMENSIONS

SCALE 2:1	DESIGN UNITS METRIC
DIMENSION STYLE MM ONLY	
DRAWN BY	DATE
DEMOE	01/04/04
CHECKED BY	DATE
APPROVED BY	DATE

THIRD ANGLE PROJECTION	REVISE ON CAD ONLY
MALE ASSEMBLY CHARTED SALES DRAWING	
MOLEX INCORPORATED	
MATERIAL NO. SEE CHART	DOCUMENT NO. SD-31110-003
SHEET NO. 1 OF 3	

THIS DRAWING CONTAINS INFORMATION THAT IS PROPRIETARY TO MOLEX INCORPORATED AND SHOULD NOT BE USED WITHOUT WRITTEN PERMISSION

3 WAY MALE HOUSING ASSEMBLY WITH XMAS TREE (VIEWED FROM MATE SIDE)

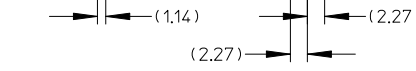
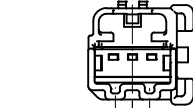
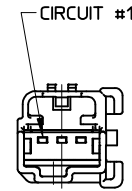
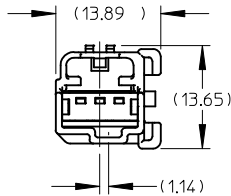
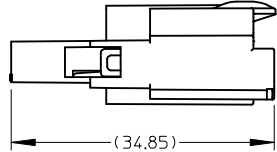
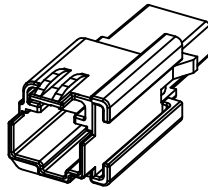
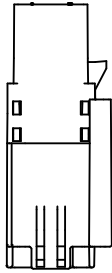

OPTION "A" OPTION "B" VIEWED FROM MATE SIDE OPTION "C"

5 WAY MALE HOUSING ASSEMBLY WITH XMAS TREE (VIEWED FROM MATE SIDE)

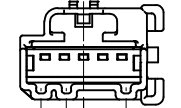
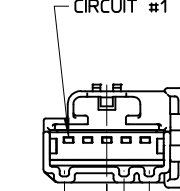
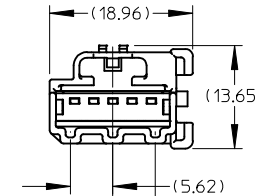
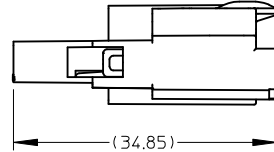
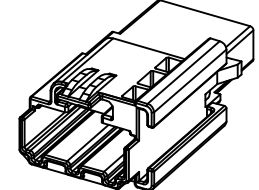
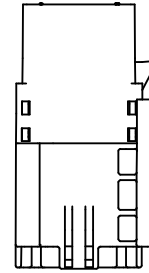

OPTION "A" OPTION "B" VIEWED FROM MATE SIDE OPTION "C"

4 WAY MALE HOUSING ASSEMBLY WITH XMAS TREE (VIEWED FROM MATE SIDE)

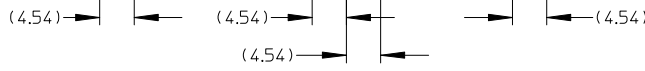
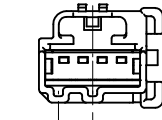
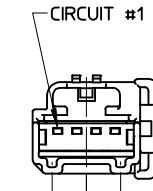
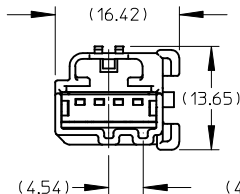
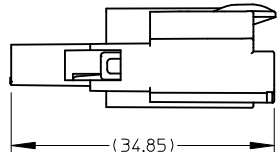
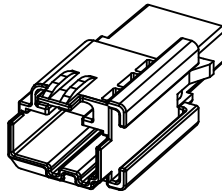
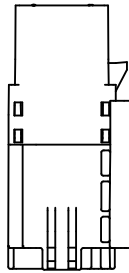

OPTION "A" OPTION "B" VIEWED FROM MATE SIDE OPTION "C"

6 WAY MALE HOUSING ASSEMBLY WITH XMAS TREE (VIEWED FROM MATE SIDE)

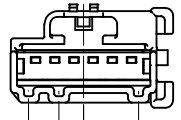
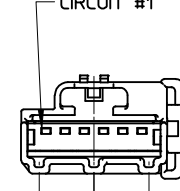
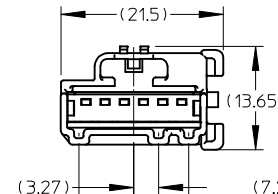
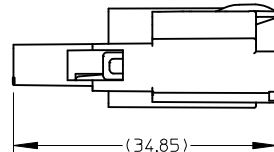
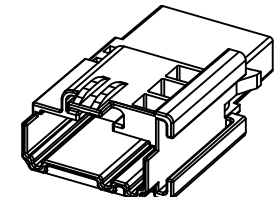
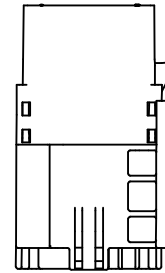

OPTION "A" OPTION "B" VIEWED FROM MATE SIDE OPTION "C"

EC NO: UAU2009-1155  
 DRWN: THERFURT009/05/12  
 CHKD: TSMITH 2009/05/14  
 APPR: TANGELLO2009/05/14

QUALITY SYMBOLS	GENERAL TOLERANCES (UNLESS SPECIFIED)	
▽ = 0	mm	INCH
	4 PLACES ± ---	± ---
▽C = 0	3 PLACES ± ---	± ---
	2 PLACES ± 0.13	± ---
	1 PLACE ± 0.25	± ---
	ANGULAR ± 1/2°	

DRAFT WHERE APPLICABLE  
 MUST REMAIN WITHIN DIMENSIONS

SCALE 2:1  
 DESIGN UNITS METRIC  
 DIMENSION STYLE MM ONLY  
 DRAWN BY DATE  
 DME0 01/04/04  
 CHECKED BY DATE  
 APPROVED BY DATE

THIRD ANGLE PROJECTION  
 REVISE ON CAD ONLY  
 TITLE  
 MALE ASSEMBLY CHARTED SALES DRAWING  
 MOLEX MOLEX INCORPORATED  
 MATERIAL NO. ENTER-PART SD-3110-003  
 DOCUMENT NO. SHEET NO. 2 OF 3  
 THIS DRAWING CONTAINS INFORMATION THAT IS PROPRIETARY TO MOLEX INCORPORATED AND SHOULD NOT BE USED WITHOUT WRITTEN PERMISSION

BILL OF MATERIALS

BILL OF MATERIALS

ASSEMBLY PART NUMBER	DESCRIPTION	XMAS TREE ATTACHMENT FEATURE	PART NUMBER	DESCRIPTION	COLOR
31067-1040	3 WAY MALE ASSEMBLY POLARIZATION "A"	NO	31112-0030	MALE HOUSING	BLACK
			31114-0030	TPA	NATURAL (WHITE)
31067-1041	3 WAY MALE ASSEMBLY POLARIZATION "B"	NO	31112-0031	MALE HOUSING	GRAY
			31114-0030	TPA	NATURAL (WHITE)
31067-1042	3 WAY MALE ASSEMBLY POLARIZATION "C"	NO	31112-0032	MALE HOUSING	BROWN
			31114-0030	TPA	NATURAL (WHITE)
31067-1070	3 WAY MALE ASSEMBLY POLARIZATION "A"	YES	31112-1030	MALE HOUSING	BLACK
			31114-0030	TPA	NATURAL (WHITE)
31067-1071	3 WAY MALE ASSEMBLY POLARIZATION "B"	YES	31112-1031	MALE HOUSING	GRAY
			31114-0030	TPA	NATURAL (WHITE)
31067-1072	3 WAY MALE ASSEMBLY POLARIZATION "C"	YES	31112-1032	MALE HOUSING	BROWN
			31114-0030	TPA	NATURAL (WHITE)
31068-1040	4 WAY MALE ASSEMBLY POLARIZATION "A"	NO	31166-0040	MALE HOUSING	BLACK
			31167-0040	TPA	NATURAL (WHITE)
31068-1041	4 WAY MALE ASSEMBLY POLARIZATION "B"	NO	31166-0031	MALE HOUSING	GRAY
			31167-0040	TPA	NATURAL (WHITE)
31068-1042	4 WAY MALE ASSEMBLY POLARIZATION "C"	NO	31166-0032	MALE HOUSING	BROWN
			31167-0040	TPA	NATURAL (WHITE)
31068-1070	4 WAY MALE ASSEMBLY POLARIZATION "A"	YES	31166-1040	MALE HOUSING	BLACK
			31167-0040	TPA	NATURAL (WHITE)
31068-1071	4 WAY MALE ASSEMBLY POLARIZATION "B"	YES	31166-1041	MALE HOUSING	GRAY
			31167-0040	TPA	NATURAL (WHITE)
31068-1072	4 WAY MALE ASSEMBLY POLARIZATION "C"	YES	31166-1042	MALE HOUSING	BROWN
			31167-0040	TPA	NATURAL (WHITE)

ASSEMBLY PART NUMBER	DESCRIPTION	XMAS TREE ATTACHMENT FEATURE	PART NUMBER	DESCRIPTION	COLOR
31072-1040	5 WAY MALE ASSEMBLY POLARIZATION "A"	NO	31169-0050	MALE HOUSING	BLACK
			31170-0050	TPA	NATURAL (WHITE)
31072-1041	5 WAY MALE ASSEMBLY POLARIZATION "B"	NO	31169-0051	MALE HOUSING	GRAY
			31170-0050	TPA	NATURAL (WHITE)
31072-1042	5 WAY MALE ASSEMBLY POLARIZATION "C"	NO	31169-0052	MALE HOUSING	BROWN
			31170-0050	TPA	NATURAL (WHITE)
31072-1070	5 WAY MALE ASSEMBLY POLARIZATION "A"	YES	31169-1050	MALE HOUSING	BLACK
			31170-0050	TPA	NATURAL (WHITE)
31072-1071	5 WAY MALE ASSEMBLY POLARIZATION "B"	YES	31169-1051	MALE HOUSING	GRAY
			31170-0050	TPA	NATURAL (WHITE)
31072-1072	5 WAY MALE ASSEMBLY POLARIZATION "C"	YES	31169-1052	MALE HOUSING	BROWN
			31170-0050	TPA	NATURAL (WHITE)
31073-1040	6 WAY MALE ASSEMBLY POLARIZATION "A"	NO	31172-0060	MALE HOUSING	BLACK
			31173-0060	TPA	NATURAL (WHITE)
31073-1041	6 WAY MALE ASSEMBLY POLARIZATION "B"	NO	31172-0061	MALE HOUSING	GRAY
			31173-0060	TPA	NATURAL (WHITE)
31073-1042	6 WAY MALE ASSEMBLY POLARIZATION "C"	NO	31172-0062	MALE HOUSING	BROWN
			31173-0060	TPA	NATURAL (WHITE)
31073-1070	6 WAY MALE ASSEMBLY POLARIZATION "A"	YES	31172-1060	MALE HOUSING	BLACK
			31173-0060	TPA	NATURAL (WHITE)
31073-1071	6 WAY MALE ASSEMBLY POLARIZATION "B"	YES	31172-1061	MALE HOUSING	GRAY
			31173-0060	TPA	NATURAL (WHITE)
31073-1072	6 WAY MALE ASSEMBLY POLARIZATION "C"	YES	31172-1062	MALE HOUSING	BROWN
			31173-0060	TPA	NATURAL (WHITE)

EC NO: UAU2009-1155 DRWN: THERFU2009/05/12 CHK: TANGELL2009/05/14 APPR: MKNACK 2009/05/14	QUALITY SYMBOLS	GENERAL TOLERANCES (UNLESS SPECIFIED)		SCALE 2:1	DESIGN UNITS METRIC	THIRD ANGLE PROJECTION	REVISE ON CAD ONLY
	▽ - 0 ▽ - 0	mm		DIMENSION STYLE MM ONLY		MALE ASSEMBLY CHARTED SALES DRAWING	
		4 PLACES ± --- ± ---	3 PLACES ± --- ± ---	DRAWN BY DATE		DEMOE 01/04/04	
		2 PLACES ± 0.13 ± ---	1 PLACE ± 0.25 ± ---	CHECKED BY DATE		MOLEX INCORPORATED	
		ANGULAR ± 1/2 °		APPROVED BY DATE		MATERIAL NO. SEE CHART	DOCUMENT NO. SD-31110-003
		DRAFT WHERE APPLICABLE MUST REMAIN WITHIN DIMENSIONS		THIS DRAWING CONTAINS INFORMATION THAT IS PROPRIETARY TO MOLEX INCORPORATED AND SHOULD NOT BE USED WITHOUT WRITTEN PERMISSION		SHEET NO. 3 OF 3	