

# NUP4000

## ESD Protection Diode Array

### Bi-directional ESD Protection for High-Speed Data Line

The NUP4000 surge protection is designed to protect equipment attached to up to four high speed communication lines from ESD, EFT, and lightning.

#### Features:

- SO-8 Package
- Peak Power – 400 W 8 x 20  $\mu$ S
- ESD Rating:  
IEC 61000-4-2 (ESD)  $\pm 15$  kV (air)  $\pm 8$  kV (contact)  
IEC 61000-4-4 (EFT) 40 A (5/50 ns)  
IEC 61000-4-5 (lightning) 12 A (8/20  $\mu$ s)
- UL Flammability Rating of 94 V-0
- These Devices are Pb-Free, Halogen Free/BFR Free and are RoHS Compliant

#### Typical Applications:

- High Speed Communication Line Protection
- 15 V Data and I/O Lines
- Microprocessor Based Equipment
- LAN/WAN Equipment
- Servers
- Notebook and Desktop PC
- Serial and Parallel Ports
- Peripherals

#### MAXIMUM RATINGS

Rating	Symbol	Value	Unit
Peak Power Dissipation 8 x 20 $\mu$ s @ $T_A = 25^\circ\text{C}$ (Note 1)	$P_{pk}$	400	W
Peak Pulse Current 8 x 20 $\mu$ s @ $T_A = 25^\circ\text{C}$ (Note 1)	$I_{pp}$	10	A
Junction and Storage Temperature Range	$T_J, T_{stg}$	-55 to +150	$^\circ\text{C}$
Lead Solder Temperature – Maximum 10 Seconds Duration	$T_L$	260	$^\circ\text{C}$

1. Non-repetitive current pulse 8 x 20  $\mu$ S exponential decay waveform



ON Semiconductor®

[www.onsemi.com](http://www.onsemi.com)

### SO-8 VOLTAGE SUPPRESSOR 400 WATTS PEAK POWER 15 VOLTS

#### PIN CONFIGURATION AND SCHEMATIC

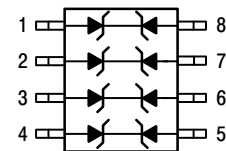

SO-8  
CASE 751

#### MARKING DIAGRAM

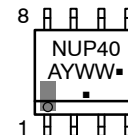

A = Assembly Location  
Y = Year  
WW = Work Week  
▪ = Pb-Free Package

(Note: Microdot may be in either location)

#### ORDERING INFORMATION

Device	Package	Shipping†
NUP4000DR2G	SO-8 (Pb-Free)	2500 / Tape & Reel

†For information on tape and reel specifications, including part orientation and tape sizes, please refer to our Tape and Reel Packaging Specification Brochure, BRD8011/D.

# NUP4000

## ELECTRICAL CHARACTERISTICS

Characteristic	Symbol	Min	Typ	Max	Unit
Reverse Working Voltage	$V_{RWM}$	-	-	15	V
Reverse Breakdown Voltage @ $I_t = 1.0$ mA	$V_{BR}$	16.7	-	-	V
Reverse Leakage Current @ $V_{RWM} = 15$ Volts	$I_R$	N/A	-	1.0	$\mu$ A
Maximum Clamping Voltage @ $I_{PP} = 1.0$ A, $8 \times 20$ $\mu$ S	$V_C$	N/A	-	24	V
Maximum Clamping Voltage @ $I_{PP} = 5.0$ A, $8 \times 20$ $\mu$ S	$V_C$	N/A	-	30	V
Maximum Peak Pulse Current	$I_{PP}$	-	-	10	A
Junction Capacitance @ $V_R = 0$ V, $f = 1$ MHz	$C_J$	-	-	75	pF

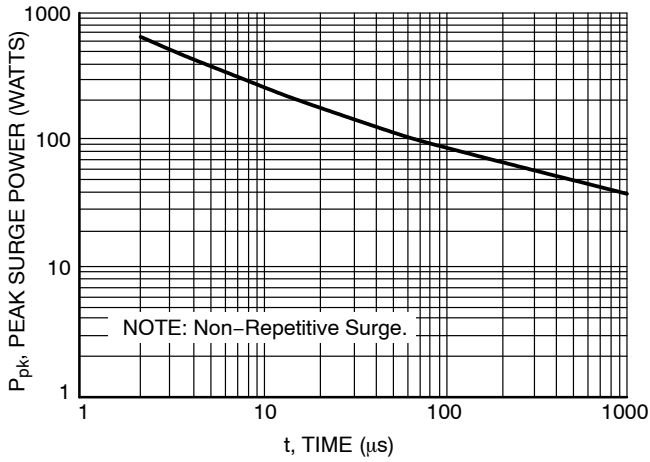

Figure 1. Pulse Width

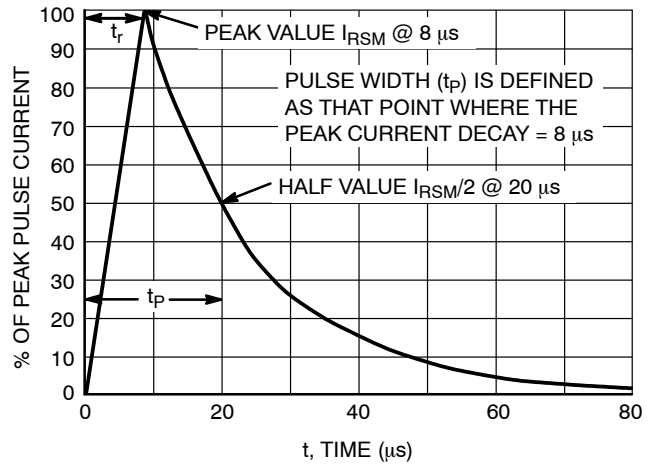
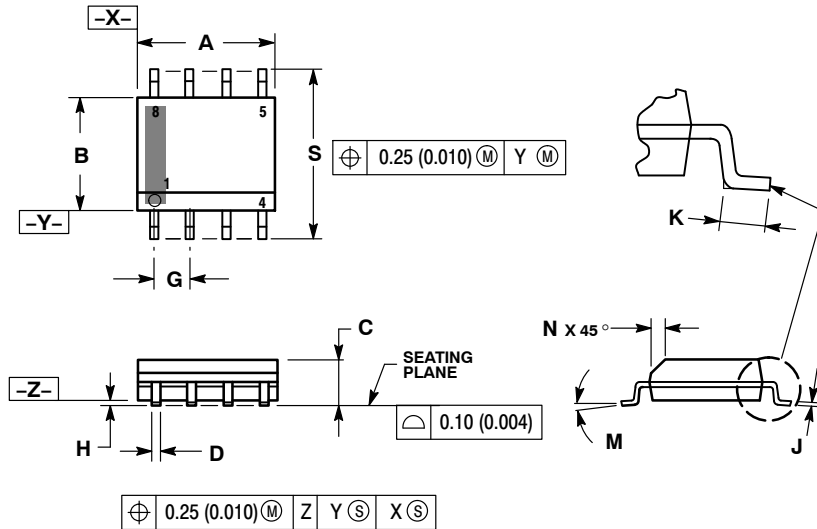

Figure 2.  $8 \times 20$   $\mu$ s Pulse Waveform

# NUP4000

## PACKAGE DIMENSIONS

SOIC-8 NB  
CASE 751-07  
ISSUE AK



**NOTES:**

1. DIMENSIONING AND TOLERANCING PER ANSI Y14.5M, 1982.
2. CONTROLLING DIMENSION: MILLIMETER.
3. DIMENSION A AND B DO NOT INCLUDE MOLD PROTRUSION.
4. MAXIMUM MOLD PROTRUSION 0.15 (0.006) PER SIDE.
5. DIMENSION D DOES NOT INCLUDE DAMBAR PROTRUSION. ALLOWABLE DAMBAR PROTRUSION SHALL BE 0.127 (0.005) TOTAL IN EXCESS OF THE D DIMENSION AT MAXIMUM MATERIAL CONDITION.
6. 751-01 THRU 751-06 ARE OBSOLETE. NEW STANDARD IS 751-07.

DIM	MILLIMETERS		INCHES	
	MIN	MAX	MIN	MAX
A	4.80	5.00	0.189	0.197
B	3.80	4.00	0.150	0.157
C	1.35	1.75	0.053	0.069
D	0.33	0.51	0.013	0.020
G	1.27 BSC		0.050 BSC	
H	0.10	0.25	0.004	0.010
J	0.19	0.25	0.007	0.010
K	0.40	1.27	0.016	0.050
M	0° - 8°		0° - 8°	
N	0.25	0.50	0.010	0.020
S	5.80	6.20	0.228	0.244

### SOLDERING FOOTPRINT\*

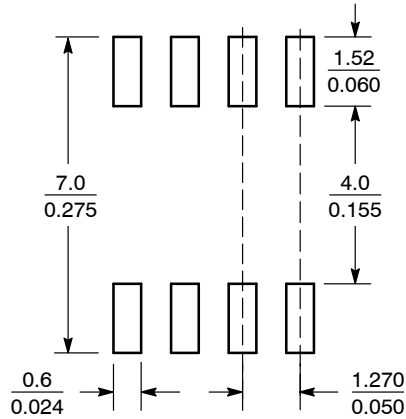

SCALE 6:1 ( $\frac{\text{mm}}{\text{inches}}$ )

\*For additional information on our Pb-Free strategy and soldering details, please download the ON Semiconductor Soldering and Mounting Techniques Reference Manual, SOLDERRM/D.

# NUP4000

ON Semiconductor and  are trademarks of Semiconductor Components Industries, LLC dba ON Semiconductor or its subsidiaries in the United States and/or other countries. ON Semiconductor owns the rights to a number of patents, trademarks, copyrights, trade secrets, and other intellectual property. A listing of ON Semiconductor's product/patent coverage may be accessed at [www.onsemi.com/site/pdf/Patent-Marking.pdf](http://www.onsemi.com/site/pdf/Patent-Marking.pdf). ON Semiconductor reserves the right to make changes without further notice to any products herein. ON Semiconductor makes no warranty, representation or guarantee regarding the suitability of its products for any particular purpose, nor does ON Semiconductor assume any liability arising out of the application or use of any product or circuit, and specifically disclaims any and all liability, including without limitation special, consequential or incidental damages. Buyer is responsible for its products and applications using ON Semiconductor products, including compliance with all laws, regulations and safety requirements or standards, regardless of any support or applications information provided by ON Semiconductor. "Typical" parameters which may be provided in ON Semiconductor data sheets and/or specifications can and do vary in different applications and actual performance may vary over time. All operating parameters, including "Typicals" must be validated for each customer application by customer's technical experts. ON Semiconductor does not convey any license under its patent rights nor the rights of others. ON Semiconductor products are not designed, intended, or authorized for use as a critical component in life support systems or any FDA Class 3 medical devices or medical devices with a same or similar classification in a foreign jurisdiction or any devices intended for implantation in the human body. Should Buyer purchase or use ON Semiconductor products for any such unintended or unauthorized application, Buyer shall indemnify and hold ON Semiconductor and its officers, employees, subsidiaries, affiliates, and distributors harmless against all claims, costs, damages, and expenses, and reasonable attorney fees arising out of, directly or indirectly, any claim of personal injury or death associated with such unintended or unauthorized use, even if such claim alleges that ON Semiconductor was negligent regarding the design or manufacture of the part. ON Semiconductor is an Equal Opportunity/Affirmative Action Employer. This literature is subject to all applicable copyright laws and is not for resale in any manner.

## PUBLICATION ORDERING INFORMATION

### LITERATURE FULFILLMENT:

Literature Distribution Center for ON Semiconductor  
19521 E. 32nd Pkwy, Aurora, Colorado 80011 USA  
**Phone:** 303-675-2175 or 800-344-3860 Toll Free USA/Canada  
**Fax:** 303-675-2176 or 800-344-3867 Toll Free USA/Canada  
**Email:** [orderlit@onsemi.com](mailto:orderlit@onsemi.com)

**N. American Technical Support:** 800-282-9855 Toll Free  
USA/Canada  
**Europe, Middle East and Africa Technical Support:**  
Phone: 421 33 790 2910  
**Japan Customer Focus Center**  
Phone: 81-3-5817-1050

**ON Semiconductor Website:** [www.onsemi.com](http://www.onsemi.com)  
**Order Literature:** <http://www.onsemi.com/orderlit>  
For additional information, please contact your local  
Sales Representative