

**General Safety Instructions:**

READ SAFETY INSTRUCTIONS

**Servicing:**

These products are not customer serviceable. TDK-Lambda UK LTD. and their authorised agents only are permitted to carry out repairs.

**Critical Components:**

These products are not authorised for use as critical components in nuclear control systems, life support systems or equipment for use in hazardous environments without the express written approval of the Managing Director of TDK-Lambda EMEA.

**Product Usage:**

These products are designed for use within a host equipment which restricts access to authorised competent personnel.

**Environmental:**

These products are IPX0, and therefore chemicals/solvents, cleaning agents and other liquids must not be used.

**Environment:**

This power supply is a switch mode power supply for use in applications within a Pollution Degree 2, overvoltage category II environment. Material Group IIIb PCB's are used within it.

**Output Loading:**

The output power taken from the power supply must not exceed the rating stated on the power supply label, except as stated in the product limitations in this handbook.

**Input Parameters:**

This product must be operated within the input parameters stated in the product limitations in this handbook.

**End of Life Disposal:**

The unit contains components that require special disposal. Make sure that the unit is properly disposed of at the end of its service life and in accordance with local regulations.



RISK OF ELECTRIC SHOCK

**High Voltage Warning:**

Dangerous voltages are present within the power supply. The professional installer must protect service personnel from inadvertent contact with these dangerous voltages in the end equipment.

This product must be reliably earthed and professionally installed in accordance with the prevailing local electrical wiring regulations and safety standards.

**CAUTION: DOUBLE POLE/NEUTRAL FUSING**

The (+) or (-) output(s) can be earthed or left floating.

The unit cover(s)/chassis (where applicable) must not be made user accessible.

The mains input connector is not acceptable for use as field wiring terminals.

For encased products, do not use mounting screws, which penetrate the unit more than 4.5mm.

Internal fuses protect the unit and must not be replaced by the user. In case of internal defect, the unit must be returned to TDK-Lambda UK LTD or one of their authorised agents.

**WARNING:** These products are Class 1 and must therefore be reliably earthed and professionally installed in accordance with the prevailing electrical wiring regulations and the safety standards covered herein.

For uncased models, H1 to H4 must be connected to protective earth. H1 to H4 fixing screw head/washer diameter must not exceed 6mm.

A suitable mechanical, electrical and fire enclosure must be provided by the end use equipment for mechanical, electric shock and fire hazard protection.

**Energy Hazards:**

The main output of this product is capable of providing hazardous energy (240VA). Final equipment manufacturers must provide protection to service personnel against inadvertent contact with the output terminals.

The ventilation openings on these products must not be impeded. Ensure that there is at least 50mm spacing between any obstruction and the ventilation openings.

The unit cover/chassis, where applicable, is designed to protect skilled personnel from hazards. They must not be used as part of the external covers of any equipment where they may be accessible to operators, since under full load conditions, part or parts of the unit chassis may reach temperatures in excess of those considered safe for operator access.

**Allgemeine Sicherheitsvorschriften:**

LESEN SIE DIE SICHERHEITSVORSCHRIFTEN

**Wartung:**

Diese Produkte können nicht durch den Kunden gewartet werden. Nur TDK-Lambda UK LTD. und deren zugelassene Vertriebshändler sind zur Durchführung von Reparaturen berechtigt.

**Kritische Komponenten:**

Diese Produkte sind nicht für die Verwendung als kritische Komponenten in nuklearen Kontrollsystemen, Lebenserhaltungssystemen oder Geräten in gefährlichen Umgebungen geeignet, sofern dies nicht ausdrücklich und in Schriftform durch den Geschäftsführer von TDK-Lambda EMEA genehmigt wurde.

**Produktverwendung:**

Diese Produkte sind zur Verwendung innerhalb von Host-Anlagen gedacht, die einen auf das Fachpersonal beschränkten Zugang haben.

**Umwelt:**

Diese Produkte sind IPX0, aus diesem Grund dürfen keine Chemikalien/Lösungsmittel, Reinigungsmittel und andere Flüssigkeiten verwendet werden.

**Umgebung:**

Dieses Netzteil ist ein Schaltnetzteil zur Verwendung in einer Umgebung mit einem Verschmutzungsgrad 2, Überspannungskategorie II. Materialgruppe IIIb mit darin verwendeten PCBs.

**Ausgangsstrom:**

Der Ausgangsstrom des Netzteiles darf die Leistung, die auf dem Label des Netzteiles vermerkt ist, nur dann überschreiten, wenn dies in den Produktgrenzen dieses Handbuches ausgezeichnet ist.

**Eingangsparameter:**

Dieses Produkt muss innerhalb der Eingangsparameter, die in den Produktgrenzen dieses Handbuches angegeben sind, betrieben werden.

**Entsorgung am Ende der Betriebszeit:**

Das Gerät enthält Komponenten die unter Sondermüll fallen. Das Gerät muss am Ende der Betriebszeit ordnungsgemäß und in Übereinstimmung mit den regionalen Bestimmungen entsorgt werden.



GEFAHR DURCH ELEKTRISCHEN SCHLAG!

**Hochspannungswarnung:**

Innerhalb des Netzteiles gibt es gefährliche Spannungen. Der Elektroinstallateur muss das Wartungspersonal vor versehentlichem Kontakt mit den gefährlichen Spannungen im Endgerät schützen.

Dies Produkt muss sicher geerdet und von qualifiziertem Personal in Übereinstimmung mit den gültigen regionalen Bestimmungen zu Verdrahtungen sowie den Sicherheitsstandards installiert werden.

**ACHTUNG: ZWEIPOLIGE/NEUTRALE SICHERUNG**

Die (+) oder (-) Ausgänge können geerdet werden oder unangeschlossen bleiben.

Die Abdeckung des Gerätes/das Gehäuse darf für den Benutzer nicht zugänglich sein.

Der Haupteingangsanschluss ist nicht für die Verwendung als Feldverdrahtungsanschluss geeignet.

Verwenden Sie keine Befestigungsschrauben, die mehr als 4.5mm in das Gerät eindringen.

Eine interne Sicherung schützt das Gerät und darf durch den Benutzer nicht ausgetauscht werden. Im Fall von internen Defekten muss das Gerät an TDK-Lambda UK LTD oder einen der autorisierten Vertriebshändler zurückgeschickt werden.

**WARNUNG:** Diese Produkte sind Produkte der Klasse 1 und müssen daher sicher geerdet und von qualifiziertem Personal in Übereinstimmung mit den gültigen regionalen Bestimmungen zu Verdrahtungen sowie den Sicherheitsstandards installiert werden.

Für unverrohrten Modellen muss H1 bis H4 an Schutz Erde connected werden. H1 bis H4 Befestigungsschraube Kopf / Scheibe Durchmesser nicht überschreiten darf 6mm.

Ein geeignetes mechanisches, elektrisches und brandgeschütztes Gehäuse muss als Schutz vor der Gefahr von mechanischen Risiken, Stromschlägen und Brandschutz in dem Endgerät vorgesehen werden.

**Gefahren durch elektrische Energie:**

Von bestimmten Modulen kann je nach Einstellung der Ausgangsspannung gefährliche elektrische Energie ausgehen (240 VA). Die Endgerätehersteller müssen einen Schutz für Servicepersonal vor unbeabsichtigtem Kontakt mit den Ausgangsanschlüssen dieser Module vorsehen. Kann aufgrund der Einstellung gefährliche elektrische Energie auftreten, dürfen die Modulanschlüsse für den Benutzer nicht zugänglich sein.

Das Gerät darf in jeder Position befestigt werden, mit Ausnahme über Kopf (umgekehrt) oder vertikal mit dem Luftstrom abwärts.

Die Belüftungsöffnungen an diesem Produkt dürfen nicht blockiert werden. Achten Sie darauf, dass mindestens 50 mm Abstand zwischen Hindernissen und den Belüftungsöffnungen bleibt.

Die Geräteabdeckung/das Gehäuse ist so entworfen, dass das Fachpersonal vor Gefahren geschützt wird. Sie dürfen nicht als Teil der externen Abdeckung für Geräte verwendet werden, die für den Betreiber zugänglich sein müssen, da Teile oder das gesamte Gerätegehäuse unter voller Auslastung übermäßige Temperaturen erreichen kann, die für den Zugang des Betreibers nicht mehr als sicher betrachtet werden.

**Consignes générales de sécurité:**

LIRE LES CONSIGNES DE SECURITE

**Entretien:**

Ces produits ne peuvent pas être réparés par l'utilisateur. Seuls, TDK-Lambda UK LTD et ses agents agréés sont autorisés à effectuer des réparations.

**Composants critiques:**

Ces produits ne doivent pas être utilisés en tant que composants critiques dans des systèmes de commande nucléaire, dans des systèmes de sauvetage ou dans des équipements utilisés dans des environnements dangereux, sans l'autorisation écrite expresse du directeur général de TDK-Lambda EMEA.

**Utilisation du produit:**

Ces produits sont conçus pour être utilisés dans un équipement hôte dont l'accès n'est autorisé qu'aux personnes compétentes.

**Environnement:**

Ces produits sont IPX0, et donc on ne doit pas utiliser des produits chimiques/solvants, des produits de nettoyage et d'autres liquides.

**Environnement fonctionnel :**

Cette alimentation fonctionne en mode commutation pour utilisation dans des applications fonctionnant dans un environnement avec Degré de Pollution 2 et catégorie de surtension II. Elle utilise des cartes des circuits imprimés (PCB) de Groupe IIIb.

**Intensité soutirée:**

L'intensité soutirée de l'alimentation ne doit pas dépasser l'intensité nominale marquée sur la plaque signalétique, sauf indications contraires dans les limitations du produit décrit dans ce manuel.

**Paramètres d'entrée:**

Ce produit doit être utilisé à l'intérieur des paramètres d'entrée indiqués dans les limitations du produit dans ce manuel.

**Elimination en fin de vie:**

L'alimentation contient des composants nécessitant des dispositions spéciales pour leur élimination. Vérifiez que cette alimentation est mise au rebut correctement en fin de vie utile et conformément aux réglementations locales en vigueur.



RISQUE DE CHOC ELECTRIQUE

**Attention-Danger haute tension:**

Des tensions dangereuses sont présentes dans l'alimentation. L'installateur doit protéger le personnel d'entretien contre un contact involontaire avec ces tensions dangereuses dans l'équipement final.

Ce produit doit être raccordé à une terre fiable et installé par des professionnels en respectant les réglementations locales de câblages électriques en vigueur et les normes de sécurité.

**ATTENTION: FUSIBLE BIPOLAIRE/NEUTRE**

Les sorties (+) ou (-) peuvent être raccordées à la terre ou laissées flottantes.

Le couvercle/châssis de l'alimentation ne doit pas être accessible à l'utilisateur.

Le connecteur d'entrée d'alimentation principale ne doit pas être utilisé comme borne de raccordement.

N'utilisez pas de vis pénétrant dans le module sur une profondeur supérieure à 4.5 mm.

Un fusible interne protège le module et ne doit pas être remplacé par l'utilisateur. En cas de défaut interne, le module doit être renvoyé à TDK-Lambda UK LTD ou l'un de ses agents agréés.

**AVERTISSEMENT:** Ces produits sont des produits Classe 1 et donc doivent être raccordés à une terre fiable et installés par un professionnel en respectant les réglementations de câblage électrique en vigueur et les normes de sécurité indiquées ici.

Pour les modèles non enveloppé, H1 à H4 doivent être connectés à la terre. H1 à H4 tête de la vis de fixation de diamètre laveuse / ne doit pas dépasser 6 mm.

Une enceinte appropriée doit être prévue par l'utilisateur final pour assurer la protection contre les chocs mécaniques, les chocs électriques et l'incendie.

**Energies dangereuses :**

Certains modules peuvent générer une énergie dangereuse (240 VA) selon le réglage de tension de sortie. Le fabricant de l'équipement final doit assurer la protection des techniciens d'entretien contre un contact involontaire avec les bornes de sortie de ces modules. Si une telle tension dangereuse risque de se produire, les bornes ou les connexions du module ne doivent pas être accessibles par l'utilisateur.

Les orifices de ventilation sur ces produits ne doivent pas être obstrués. Vérifiez qu'il y a un espace libre d'au moins 50 mm entre une obstruction et les orifices de ventilation.

Le couvercle et le châssis du module sont conçus pour protéger des personnels expérimentés. Ils ne doivent pas être utilisés comme couvercles extérieurs d'un équipement, accessible aux opérateurs car en condition de puissance maximum, des parties du châssis peuvent atteindre des températures considérées comme dangereuses pour l'opérateur.

**Norme generali di sicurezza:**

SI PREGA DI LEGGERE LE NORME DI SICUREZZA

**Manutenzione:**

Il cliente non può eseguire alcuna manutenzione su questi prodotti. L'esecuzione delle eventuali riparazioni è consentita solo a TDK-Lambda UK LTD e ai suoi agenti autorizzati.

**Componenti critici:**

Non si autorizza l'uso di questi prodotti come componenti critici all'interno di sistemi di controllo nucleari, sistemi necessari alla sopravvivenza o apparecchiature destinate all'impiego in ambienti pericolosi, senza l'esplicita approvazione scritta dell'Amministratore Delegato di TDK-Lambda EMEA.

**Uso dei prodotti:**

Questi prodotti sono progettati per l'uso all'interno di un'apparecchiatura ospite che limiti l'accesso al solo personale competente e autorizzato.

**Condizioni ambientali:**

Questi prodotti sono classificati come IPX0, dunque non devono essere utilizzati sostanze chimiche/solventi, prodotti per la pulizia o liquidi di altra natura.

**Ambiente:**

Questo prodotto è un alimentatore a commutazione, destinato all'uso in applicazioni rientranti in ambienti con le seguenti caratteristiche: Livello inquinamento 2, Categoria sovratensione II. Questo prodotto contiene schede di circuiti stampati in materiali di Gruppo IIIb.

**Carico in uscita:**

La potenza in uscita ottenuta dall'alimentatore non deve superare la potenza nominale indicata sulla targhetta dell'alimentatore, fatto salvo dove indicato nei limiti per il prodotto specificati in questo manuale.

**Parametri di alimentazione:**

Questo prodotto deve essere utilizzato entro i parametri di alimentazione indicati nei limiti per il prodotto, specificati in questo manuale.

**Smaltimento:**

L'unità contiene componenti che richiedono procedure speciali di smaltimento. Accertarsi che l'unità venga smaltita in modo corretto al termine della vita utile e nel rispetto delle normative locali.



RISCHIO DI SCOSSA ELETTRICA

**Avvertimento di alta tensione:**

All'interno dell'alimentatore sono presenti tensioni pericolose. Gli installatori professionali devono proteggere il personale di manutenzione dal rischio di contatto accidentale con queste tensioni pericolose all'interno dell'apparecchiatura finale.

Questo prodotto deve essere messo a terra in modo affidabile e installato in modo professionale, nel rispetto delle norme di sicurezza e dei regolamenti vigenti in ambito locale in materia di collegamenti elettrici.

**ATTENZIONE: PROTEZIONE CON FUSIBILE BIPOLARE/NEUTRO**

Le uscite (+) o (-) possono essere messa a terra o lasciate isolate.

I coperchi/il telaio dell'unità non devono essere accessibili da parte dell'utente.

Il connettore dell'alimentazione principale non può essere utilizzato come terminale di collegamento di campo.

Non utilizzare viti che penetrano nell'unità per più di 4.5 mm.

Un fusibile interno protegge l'unità e non deve essere sostituito dall'utente. Nell'eventualità di un difetto interno, restituire l'unità a TDK-Lambda UK LTD o a uno dei suoi agenti autorizzati.

**AVVERTIMENTO:** Questi prodotti sono di Classe 1 e come tali devono essere messi a terra in modo affidabile e installati in modo professionale, nel rispetto dei regolamenti vigenti in ambito locale in materia di collegamenti elettrici e nelle norme di sicurezza in essi contemplati.

Per i modelli non avvolto, H1-H4 devono essere connected alla terra di protezione. H1-H4 testa della vite di fissaggio / rondella diametro non deve superare i 6 millimetri.

L'apparecchiatura finale deve includere una recinzione meccanica, elettrica e antincendio per proteggere dai pericoli di natura meccanica, dalle scosse elettriche e dai pericoli di incendio.

**Pericoli energetici:**

Alcuni moduli sono in grado di erogare energia pericolosa (240 VA) a seconda della tensione in uscita impostata. I produttori delle apparecchiature finali sono tenuti a proteggere il personale di manutenzione dal rischio di contatto accidentale con questi terminali dei moduli di uscita. Se impostati su livelli che non escludono l'erogazione di energia pericolosa, questi terminali o collegamenti non devono risultare accessibili da parte dell'utente.

L'unità può essere installata in qualunque orientamento, ma non in posizione capovolta o in posizione verticale con il flusso dell'aria rivolto verso il basso.

Le griglie di ventilazione su questi prodotti non devono essere ostruite. Verificare che vi sia una distanza minima di 50 mm fra le griglie di ventilazione e qualsiasi eventuale ostruzione.

Il coperchio/telaio dell'unità è realizzato per proteggere il personale esperto dai pericoli. Non deve essere usato come parte degli involucri esterni di qualsiasi apparecchiatura, se risulta accessibile da parte degli addetti, poiché è possibile che in condizioni di pieno carico una o più parti del telaio dell'unità giunga/giungano a temperature superiori ai limiti considerati sicuri per l'accesso da parte degli addetti.



**Instrucciones generales de seguridad:**

LEA LAS INSTRUCCIONES DE SEGURIDAD

**Servicio:**

Estos productos no pueden ser reparados por los clientes. TDK-Lambda UK LTD. y sus agentes autorizados son los únicos que pueden llevar a cabo las reparaciones.

**Componentes fundamentales:**

Estos productos no pueden ser utilizados como componentes fundamentales en sistemas de control nuclear, sistemas de soporte vital o equipos a utilizar en entornos peligrosos sin el consentimiento expreso por escrito del Director General de TDK-Lambda EMEA.

**Uso de los productos:**

Estos productos han sido diseñados para ser utilizados en un equipo central que restrinja el acceso al personal cualificado autorizado.

**Medioambiental:**

Estos productos son IPX0 y, por tanto, no pueden utilizarse sustancias químicas/disolventes, agentes de limpieza ni otros líquidos.

**Medio ambiente:**

Esta fuente de alimentación es una fuente de alimentación de modo conmutado a utilizar en aplicaciones dentro de un entorno con un Grado de contaminación 2 y una Categoría de sobretensión II. En él se utilizan policloruros de bifenilo del Grupo de materiales IIIb.

**Carga de salida:**

La potencia de salida tomada de la fuente de alimentación no puede sobrepasar el valor nominal indicado en la etiqueta de la fuente de alimentación, excepto en los casos indicados en las limitaciones del producto en este manual.

**Parámetros de entrada:**

Este producto debe ser utilizado dentro de los parámetros de entrada indicados en las limitaciones del producto en este manual.

**Desecho de la unidad:**

La unidad contiene componentes que deben ser desechados de una manera especial. Asegúrese de desechar correctamente la unidad al final de su vida útil y conforme a las normas locales vigentes.



PELIGRO DE DESCARGAS ELÉCTRICAS

**Advertencia de alta tensión:**

En esta fuente de alimentación hay tensiones peligrosas. El instalador profesional debe proteger al personal de servicio contra cualquier contacto accidental con estas tensiones peligrosas en el equipo final.

Este producto se puede conectar de forma fiable a tierra e instalar profesionalmente de conformidad con las regulaciones locales para los cableados eléctricos y las normas de seguridad vigentes.

**PRECAUCIÓN: PROTECCIÓN POR FUSIBLES BIPOLAR/NEUTRA**

La salida o salidas (+) o (-) pueden conectarse a tierra o se las puede dejar flotando.

Debe impedirse el acceso de los usuarios a la cubierta o cubiertas y al chasis de la unidad.

El conector de entrada de la red no es apto para ser utilizado a modo de bornes de cableado de campo.

No utilice tornillos de montaje susceptibles de penetrar en la unidad más de 4.5 mm.

Un fusible interno protege la unidad y este no debe ser nunca reemplazado por el usuario. En caso de existir algún defecto interno, la unidad debe ser enviada a TDK-Lambda UK LTD o a uno de sus agentes autorizados.

**AVISO:** Estos productos son de Clase 1 y, por tanto, se deben conectar de forma fiable a tierra y sólo pueden ser instalados por profesionales de acuerdo con con las regulaciones sobre cableados eléctricos y las normas de seguridad vigentes cubiertas en este documento.

Para los modelos sin entubar, H1 a H4 debe connected a la tierra de protección. H1-H4 se fija la cabeza del tornillo / arandela de diámetro no debe exceder de 6 mm.

El equipo de uso final debe constituir un recinto de protección mecánica, eléctrica y contra incendios de protección mecánica, contra descargas eléctricas y contra el peligro de incendios.

**Peligros de energía:**

Algunos módulos pueden generar energía peligrosa (240VA) dependiendo de la configuración de la tensión de salida. Los fabricantes de equipos finales deben proteger al personal de servicio contra un contacto accidental con estos bornes de salida de los módulos. Si se configura de modo que pueda generarse energía peligrosa, hay que evitar que el usuario pueda acceder a los bornes o conexiones del módulo.

La unidad se puede montar en cualquier orientación excepto invertida (montada sobre su parte de arriba) o vertical con los orificios para el flujo de aire mirando hacia abajo.

Las aberturas de ventilación de estos productos no deben obstruirse jamás. Asegúrese de que quede una separación de 50 mm por lo menos entre cualquier obstrucción y las aberturas de ventilación.

La cubierta/chasis de la unidad ha sido diseñada para que proteja a las personas cualificadas de los peligros. No deben ser utilizadas como parte de las cubiertas externas de cualquier equipo al que pueden acceder los operarios, ya que bajo unas condiciones de carga completa, la pieza o piezas del chasis de la unidad pueden alcanzar temperaturas superiores a las consideradas seguras para el acceso de los operarios.

**Instruções gerais de segurança:**

LEIA AS INSTRUÇÕES DE SEGURANÇA

**Manutenção:**

Estes produtos não são podem ser submetidos a manutenção por parte do cliente. Apenas a TDK-Lambda UK LTD e os seus agentes autorizados têm permissão para realizar reparações.

**Componentes essenciais:**

Não é autorizada a utilização destes produtos como componentes essenciais de sistemas de controlo nuclear, sistemas de suporte de vida ou equipamento para utilização em ambientes perigosos sem a expressa autorização por escrito do Director-Geral da TDK-Lambda EMEA.

**Utilização do produto:**

Estes produtos foram concebidos para utilização dentro de um equipamento de alojamento que apenas permita o acesso a pessoal qualificado autorizado.

**Ambiental:**

Estes produtos são IPX0 e, como tal, não se devem utilizar químicos/solventes, agentes de limpeza e outros líquidos.

**Ambiente:**

Esta fonte de alimentação é uma fonte de alimentação do modo de comutação para utilização em aplicações com um Nível de Poluição 2 e ambientes da categoria de sobretensão II. São utilizadas placas de circuitos impressos do grupo de materiais IIIb.

**Carga de saída:**

A potência de saída extraída da fonte de alimentação não deve exceder a classificação assinalada na etiqueta da fonte de alimentação, excepto quando indicado nas limitações do produto neste guia.

**Parâmetros de entrada:**

Este produto deve ser utilizado dentro dos parâmetros de entrada indicados nas limitações do produto neste guia.

**Eliminação no fim de vida:**

A unidade contém componentes que necessitam de procedimentos especiais de eliminação. Certifique-se de que a unidade é devidamente eliminada no fim da sua vida útil e que tal é feito em conformidade com os regulamentos locais.



RISCO DE CHOQUE ELÉCTRICO

**Aviso de alta tensão:**

Estão presentes tensões perigosas dentro da fonte de alimentação. O profissional que realizar a instalação deve proteger o pessoal de assistência contra contactos inadvertidos com estas tensões perigosas do equipamento final.

Este produto deve ser ligado à terra de forma fiável e instalado por um profissional, de acordo com as normas de segurança e os regulamentos locais vigentes em relação a cablagens eléctricas.

**CUIDADO: LIGAÇÃO DE FUSÍVEIS DE DOIS PÓLOS/NEUTRA**

As saídas (+) e (-) podem ser ligadas à terra ou deixadas soltas.

O chassis/cobertura(s) da unidade não deve estar acessível ao utilizador.

O conector de entrada de alimentação não deve ser utilizado como terminal de cablagens no local.

Não utilize parafusos de montagem, uma vez que estes penetrarão na unidade em mais do que 4.5 mm.

Existe um fusível interno que protege a unidade e que não deve ser substituído pelo utilizador. Em caso de defeito interno, a unidade deve ser devolvida à TDK-Lambda UK LTD ou a um dos seus agentes autorizados.

**AVISO:** Estes produtos pertencem à Classe 1, devendo assim ser ligados à terra de forma fiável e instalado por profissionais, de acordo com os regulamentos locais vigentes em relação a cablagens eléctricas e as normas de segurança aqui mencionadas.

Para os modelos sem invólucro, H1 a H4 deve ser connected à terra de protecção. H1 a H4 fixação da cabeça do parafuso / arruela de diâmetro não deve exceder 6 milímetros.

O equipamento de utilização final deve fornecer um bastidor com protecção mecânica, eléctrica e contra incêndios adequada.

**Perigos de energia:**

Alguns módulos tem a capacidade de fornecer energia perigosa (240 VA), de acordo com a configuração da tensão de saída. O equipamento final do fabricante deve garantir que o pessoal de assistência está protegido contra contactos inadvertidos com estes terminais de saída do módulo. Se essa energia perigosa for produzida, as ligações e os terminais do módulo não devem ser acessíveis pelos utilizadores.

A unidade pode ser instalada em qualquer posição, excepto invertida (montada sobre a parte superior), ou na posição vertical, com o fluxo de ar dirigindo-se para baixo.

As aberturas de ventilação destes produtos não devem ser obstruídas. Certifique-se de que existe um espaçamento de pelo menos 50 mm entre qualquer obstrução e as aberturas de ventilação.

O chassis/cobertura da unidade está concebido de forma a proteger o pessoal especializado de perigos. Não devem ser utilizados como parte das coberturas externas de qualquer equipamento em que possam estar acessíveis aos operadores, uma vez que em condições de carga máxima, algumas peças do chassis da unidade podem atingir temperaturas superiores às consideradas seguras para o acesso do operador.

**Standard Specific Safety Instructions:**

**Special Instructions for medical applications (IEC 60601-1:1988 + A1:1991 + A2:1995; EN 60601-1:1990 + A1:1993 + A2:1995; UL 60601-1, 1st Edition, 2006-04-26 (includes National Differences for USA) CAN/CSA-C22.2 No. 601.1-M90 (R2005) (includes National Differences for Canada); IEC 60601-1:2005; EN 60601-1:2006; ANSI/AAMI ES 60601-1:2005; CSA 22.2 No 60601-1:2008)- Applicable to products with L, R and T Input Filter Options only**

These products are designed for continuous operation within an overall enclosure, and must be mounted such that access to the mains terminals is restricted. See the appropriate standard listed above.

These products are NOT suitable for use in the presence of flammable anaesthetic mixtures with air or with oxygen, or with nitrous oxide.

These products have a Reinforced barrier between input and output in accordance with the standards listed above . They are NOT protected against the ingress of water.

Connect only apparatus complying with the standards listed above as appropriate to the signal ports.

All outputs have basic spacings to earth rated for mains - 250Vac, and due consideration must be given to this in the end product design.

These products have SELV outputs.

Reference should be made to local regulations concerning the disposal of these products at the end of their useful life.

Where any part of this product is made accessible to the operator in the end use equipment, the operator must not touch this part and the patient at the same time.

These products have not been assessed to IEC/EN60601-1-2 (EMC) but EMC test data is available from TDK-Lambda UK Ltd.

**WARNING: No modification of this product is allowed.**

**Special instructions for applications covered by IEC/EN/UL/CSA61010-1**

If the equipment is used in a manner not specified by the manufacturer, the protection provided by the equipment may be impaired.

**Environmental Specifications:**

Description	Operation	Storage
Use	Indoor	-
Temperature	0°C - +70°C (derating at 2.5%/°C above 50°C) - Covered by approvals.	-40°C - +70°C
Humidity	5 - 95% RH, non-condensing	5 - 95% RH, non-condensing
Altitude	-200m to 5000m for UL/CSA/IEC/EN60950-1, UL/CSA/IEC/EN61010-1 -200M to 3000m for the 60601-1 standards	-200m - 5000m
Pressure	70kPa - 106kPa	54kPa - 106kPa
Orientation	The unit may be mounted in any orientation except inverted (mounted on its top) or vertical with the airflow downwards.	ALL
Material Group	IIIb	
Pollution Degree	2	
Overvoltage Category	II	
Class	I	
Weight	1 Kg max	
IP Rating	IPX0	

**Level of Insulation:**

Dielectric Strength testing is carried out as follows:

Primary mains circuit to earth: 2.515 to 2.525kVDC

Primary mains circuits to secondary: 5.66kVDC\*

Secondary circuits to earth: 2.515 to 2.525kVDC

\*Important Note: This test is not possible with Y capacitors fitted to the unit as damage to these capacitors may occur. It is also necessary to short circuit the outputs together and to earth.

**Safety Approvals:**

UL60950-1 and CSA22.2 No.60950-1 - UL Recognised. C-UL for Canada.

IEC / EN60950-1 - CE mark.

IEC/EN60950-1 and IEC/EN60601-1 and IEC/EN61010-1 - CB Report and Certificate.

CE marking when applied to any EFE300M product indicates compliance with the Low Voltage Directive (2006/95/EC) in that it complies with EN60950-1, and with Directive 2011/65/EU of the European Parliament and of the Council of 8 June 2011 on the restriction of the use of certain hazardous substances in electrical and electronic equipment.

UL/CSA 60601-1 - UL + C -UL approval

UL/CSA 61010-1 - UL + C -UL approval

**Fusing:** Internal fuses (F1): dual fuses in the L and N line (except L option, single fuse in the live line). F8AH, 250V, 5x20mm.

**Symbols:**



**AC      DC      AC/DC      EARTH      N – Neutral      L – Live      + Positive DC      - Negative DC**

If the earth terminal of the EFE300M PSU is connected to the main incoming earth conductor of the end equipment, the installer must cover the earth symbol with a label bearing the earth symbol of IEC60417-5019.

**Nomenclature:**

EFE300M or -EFE300M models as described below:

Unit Configuration Code:

EFE300Mxy-a-b-cdef-ghijk

**Where:**

x	=	Nothing or J for Japanese models (may have non-safety differences).
y	=	Blank for Y2 capacitors from output to earth, P for Y1 capacitors from output to earth.
a	=	Channel 1 output Voltage: see Ch1 in the outputs table below, adjustment range column.
b	=	Standby voltage: see standby voltage table below or 0 for omitted
c	=	HN for Open frame, no fan, with 12V / 1A fan supply. HU for U chassis, no fan, with 12V / 1A fan supply. HC for Cover + chassis, no fan, with 12V / 1A fan supply. EC for Cover + chassis, end fan (temp controlled). NN for Open frame, no fan, no fan supply. NU for U chassis, no fan, no fan supply. NC for Cover + chassis, no fan, no fan supply. CN for Open frame, no fan, with 12V / 0.25A fan supply. CU for U chassis, no fan, with 12V / 0.25A fan supply. CC for Cover + chassis, no fan, with 12V / 0.25A fan supply.
d	=	M for molex input connector or equivalent, J for JST connector or equivalent.
e	=	D for dual fused input or L for single fuse in the live line
f	=	• S for standard Leakage, L for low Leakage, R for reduced Leakage, T for tiny Leakage. *
g	=	Y for Oring FET included or N for nothing.
h	=	E for enable, T for inhibit, N for no inhibit, no enable.
i	=	Nothing for horizontal output connector, -V for vertical output connector, -S for screw terminal
j	=	• Nothing for standard channel 1 output voltage, -xD or -xPD where D is for units with programmed negative load regulation, PD is for units with programmed positive load regulation, x is the voltage of the regulation in 100mVolts and is within the Output Adjustment range (example, 7D = 0.7V of negative load regulation, 24PD = 2.4V of positive load regulation).
k	=	Nothing or -x where x is three numbers from 0 to 9 which denotes various output voltage/current settings within the specified ranges of each output for a particular unit or blank for standard output settings. (may define non-safety related parameters/feature, e.g. reduced primary current limit, reduced OVP)

\*At 440Hz, leakage current is > 3.5mA and therefore must be assessed in the end use application.  
 L < 300uA leakage, R < 150uA leakage and T < 75uA leakage.

**Input Parameters:**

Standard	AC and/or DC		
	60601-1	60950-1	61010-1
Nominal input voltage	100-240Vac	100-240Vac or 133-318Vdc**	100-240Vac
Input voltage range	90*-264Vac	90*-264Vac or 120-350Vdc**	90*-264Vac
Input frequency range	45-63Hz	45-440Hz or DC**	45-440Hz
Maximum Input Current	4.9A rms	4.9A rms or 3.5A DC**	4.9A rms
Maximum Input Current (400W peak power for 10 second maximum)	6.4A rms	6.4A rms or 4.4A DC**	6.4A rms
Inrush Current	<40A AT 25°C	<40A AT 25°C	<40A AT 25°C

\* Channel 1 output is linearly derated from 90Vac to 85Vac, 4W per volt to 280W.

\*\* Dc ratings are for specific 60950-1, Non-standard versions only.

All ratings apply for ambient temperatures up to 50°C. From 50 to 70°C the output power is derated at 2.5% per deg C.

Input Connections: Molex 3 pin header 7A/250V MAX.

**Output Parameters:**

Output channel	Vout (V)	Adjustment range (V)	Output current (A)	Maximum power (W)
CH1	12	11.4 – 13.2*	25	300 (400**)
	24	22.8 – 26.4*	12.5	300 (400**)
	28	27 – 32*	10.72	300 (400**)
	40	36 – 42*	7.5	300 (350***)
	48	47 – 50*	6.25	300 (350***)
	50	50.1 – 54*	6.0	300 (350***)
Standby	5	Fixed	2	10
	12	Fixed	1	12
	13.5	Fixed	1	13.5
Fan output	12	Fixed	0.25	3
	12	Fixed	1	12

\* Can be adjusted from nominal at the factory only.

\*\* Peak power of 400W for 10 seconds maximum, maximum rms power of 300W:

\*\*\* Peak power of 350W for 10 seconds maximum, in any 1 minute cycle, maximum rms power of 300W:

$$\sqrt{\frac{P_{peak} \times T_1 + P_{reduced} \times T_2}{T_1 + T_2}} \leq 300W$$

where T1 = peakpower time on  
 and T2 = reduced power time on

Maximum continuous power output 300W (excluding fan output)

**Output Limitations:**

All outputs are SELV up to and including 48V nominal. Voltages above 48V nominal are non SELV and therefore all outputs are non SELV and must not be accessible to an end operator.

These products are designed for use with capacitive loads up to the value shown in the Table below. Applications where a discharged capacitor is switched onto the power supply output creates additional



loading for which a non-standard product may be required if the peak current exceeds the value shown in the Table below. Consult factory for details.

Nominal Output Voltage (V)	12	24	48
Max Capacitive Load (uF)	25000	12500	3125
Peak Current for Switched Capacitive Loads (A)	33.3	16.6	7.4

**Custom Models:**

Non Standard models.

Model: Y5J008# (where # can be any letter) or EFE300MJ-12.1-5-008 or EFE300MJ-12.1-5-008-SGP

Maximum outputs: 12.1V, 21.49A, plus 5V, 2A standby.

Maximum ambient: As standard model.

Orientations: As standard model.

Comments: Fan speed is controlled at 6600rpm up to and between 45 to 50°C ambient after which the fan speed increases to typically 10,000rpm (10V). Can be fitted with or without fan guard.

Model: Y5J006# (where # can be any letter) or EFE300MJ-12-5-006.

Maximum outputs: 11.4V to 13.2V\*, 25A, (300W max) plus 5V, 2A standby.

Maximum ambient: As standard model.

Orientations: As standard model.

Comments: Longer version than standard model to accommodate additional reservoir capacitor for a greater hold up time.

Model: Y5J015# (where # can be any letter) or EFE300MJ-12.1-5-009 or EFE300MJ-12.1-5-009-SGP

Maximum outputs: 12.1V, 24.79A plus 5V, 2A standby.

Main output may also be 11.4 to 13.2V at 25A max. Limited to 300W max.

Maximum ambient: As standard model.

Orientations: As standard model.

Comments: Model is the same as Y5J008# but is a NN.

Model Y50016# (where # can be any letter), NS-TLA/EFE300M-48.5-12-HNMDL-YE-V

Maximum outputs: 47-54V, 6.25A 300W max, plus 12V, 1A standby plus 12V, 1A fan output.

Maximum ambient: As standard model.

Orientations: As standard model.

Comments: OCP raised by 5% compared to the standard model.

Model Y50018# (where # can be any letter), NS-TLG/EFE300M-54-5-ECMDL-YT

Maximum outputs: 54V 5.5A, plus 5V, 2A standby.

Maximum ambient: As standard model.

Orientations: As standard model.

Comments: Extended U chassis with non-standard OVP to maintain SELV

Model Y50029# (where # can be any letter except E). EFE300M-13-5-HNMDS-NT-S/NS-TLA

Maximum outputs: As standard model

Maximum ambient: As standard model.

Orientations: As standard model.

Comments: Elongated PWB to accommodate additional filtering components.

Model Y50029E. EFE300M-13-5-HNMDS-NT-S/NS-TLA

Maximum outputs: As standard model

Maximum ambient: As standard model.

Orientations: As standard model.

Comments: Based on Y50029# but with a larger value boost cap, up to a maximum of 220 micro-farads, for better hold up time



**Cooling for units with customer supplied air (HN or CN, HU or CU and HC or CC options).**

The following method must be used for determining the safe operation of PSUs.

The components listed in the following table must not exceed the temperatures given. To determine the component temperatures the heating tests must be conducted in accordance with the requirements of IEC60950-1:2005 Clause 4.5. Consideration should also be give to the requirements of other safety standards.

Test requirements include: PSU to be fitted in its end-use equipment and operated under the most adverse conditions permitted in the end-use equipment handbook/specification and which will result in the highest temperatures in the PSU. To determine the most adverse conditions consideration should be given to the end use equipment maximum operating ambient, the PSU loading and input voltage, ventilation, end use equipment orientation, the position of doors & covers, etc. Temperatures should be monitored using type K fine wire thermocouples (secured with cyanoacrylate adhesive, or similar) placed on the hottest part of the component (out of any direct airflow) and the equipment should be run until all temperatures have stabilised.

**Cooling for unit temperature table:**

Circuit Ref.	Description	Max. Temperature (°C)
J1	Input connector	75
L1, L2	Common mode choke winding	115 (130)
C7, C8	X capacitors	100
C9	Reservoir capacitor (electrolytic)	60 (105)
L3	Boost choke winding	115 (140)
TX1	Transformer winding	120 (130)
TX1	Transformer core	120 (130)
TX2	Transformer winding	120 (130)
TX2	Transformer core	120 (130)
TX2	Transformer braid (to pin 13)	120 (130)
U2, U4, U5, U6	Optocoupler	75 (100)
C10, C11	Channel 1 output capacitors	80 (105)
L6	Primary choke (24V, 28V, 40V, 48V and 50V models only)	120 (130)
L4	Channel 1 Output choke	115 (130)
XU602	Fan regulator	115 (130)
XQ201	Boost FET (IMS board)	115 (130)
Q1 or Q2 or Q5	Channel 1 output FET	115 (130)
XU403	Primary IC	100 (130)
Various	All other electrolytic capacitors	80 (105)

See components to be monitored diagrams for location of components.

Higher temperature limits (in brackets) may be used but product life may be reduced.

COMPONENTS TO BE MONITORED DIAGRAMS:

Base board topside

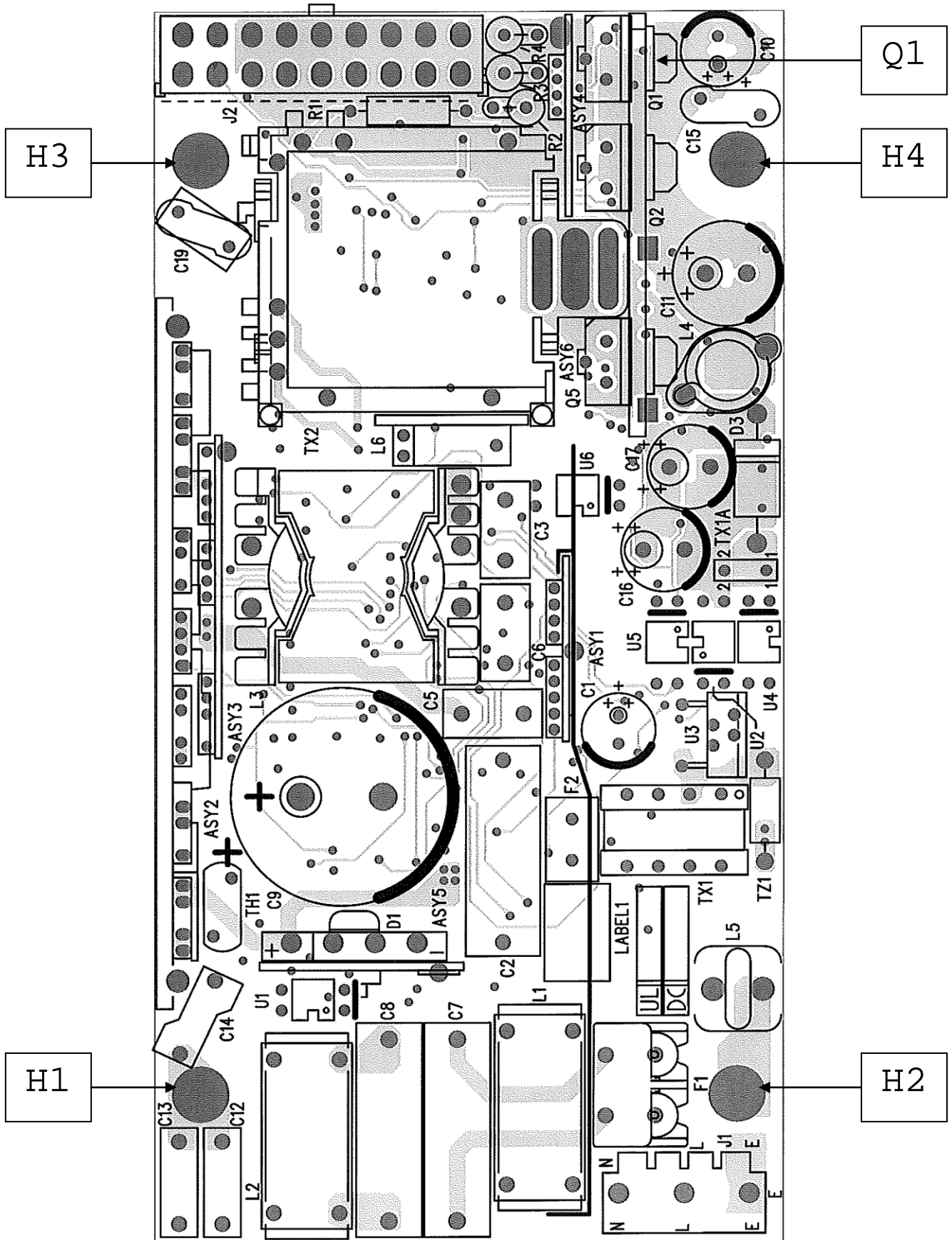

Primary IMS board

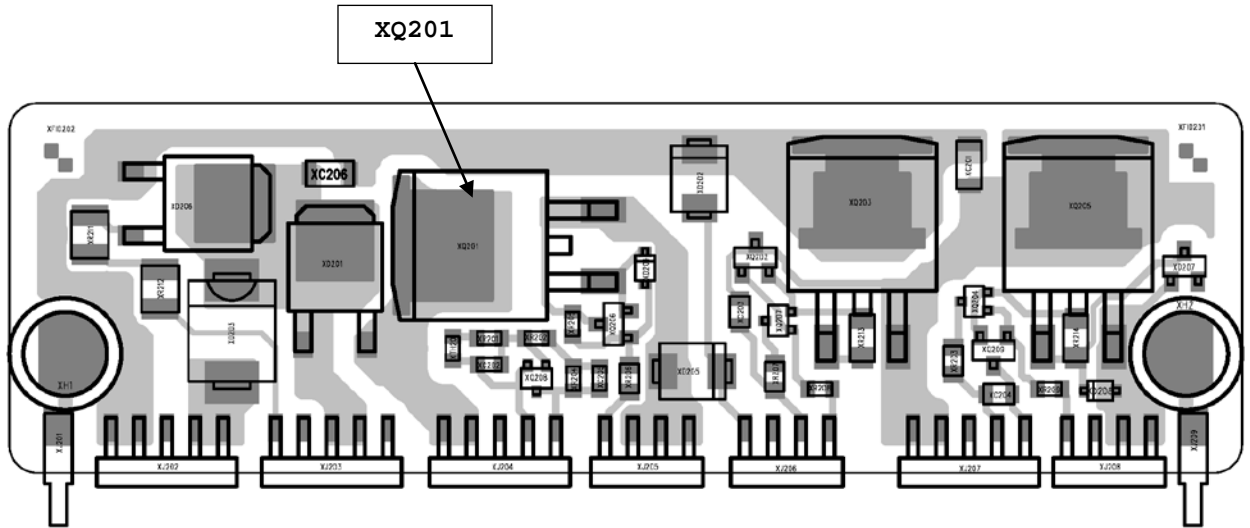

Primary control board

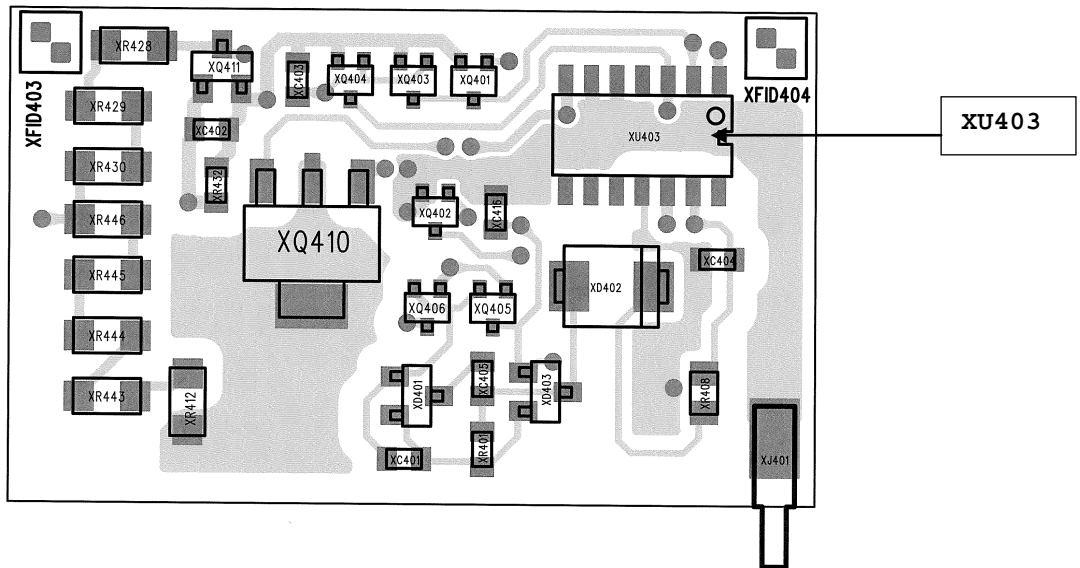

Fan control board

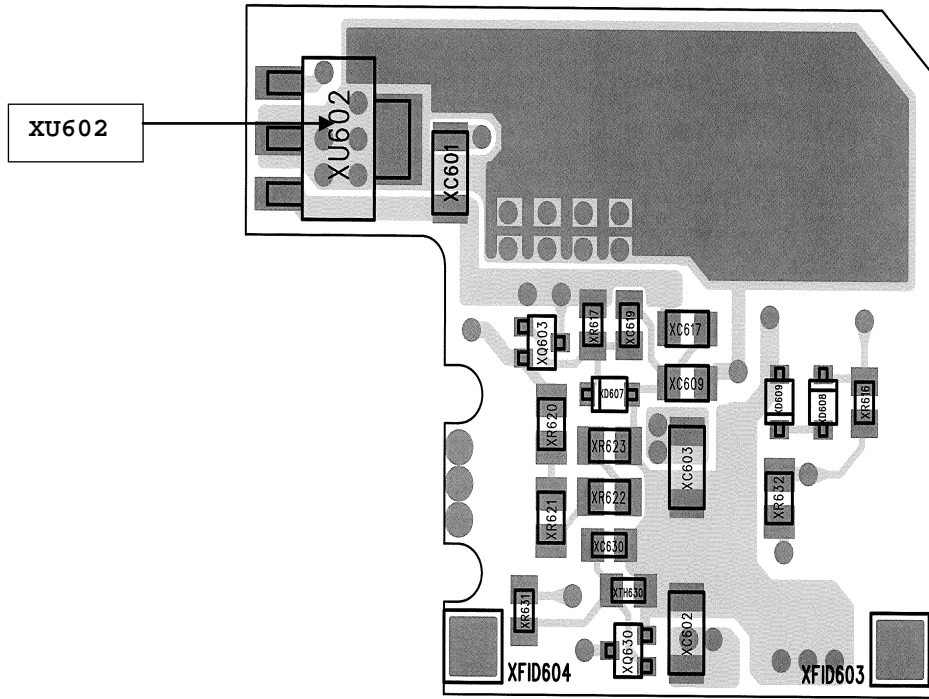

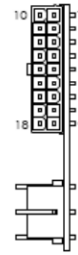
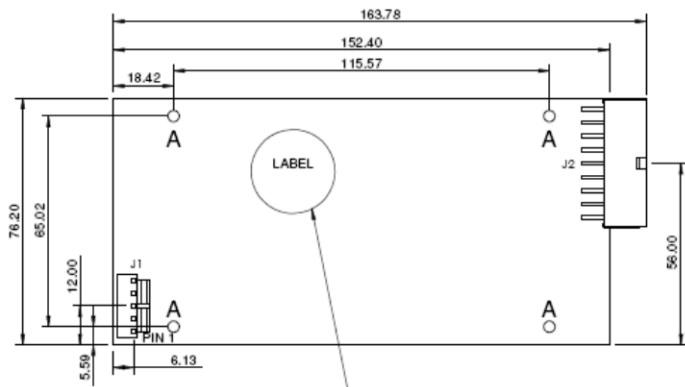

J1

PIN	CONNECTION
1	EARTH
2	NOT CONNECTED
3	LIVE
4	NOT CONNECTED
5	NEUTRAL

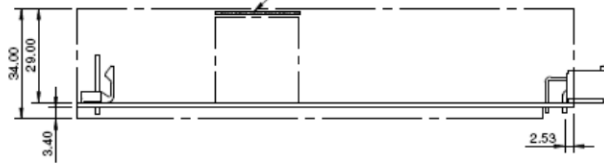

J2

PIN	CONNECTION	PIN	CONNECTION
10	0V STANDBY	1	+V STANDBY
11	POWER GOOD	2	REMOTE ON/OFF
12	0V CH1	3	+V CH1
13	0V CH1	4	+V CH1
14	0V CH1	5	+V CH1
15	0V CH1	6	+V CH1
16	0V CH1	7	+V CH1
17	0V CH1	8	+V CH1
18	+12V FAN (NOTE*1)	9	N/C

NOTE:\*1 (J) MODEL PIN N/C

MATING PARTS (MOLEX OR EQUIVALENT)

CONNECTOR	HOUSING	CRIMP PIN
J1	09-50-8051	08-52-0113
J2	39-01-2185	44476-3112

LABEL (CHASSIS WITH COVER)

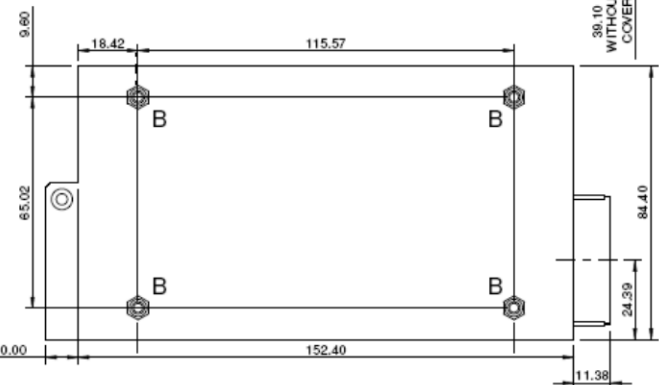
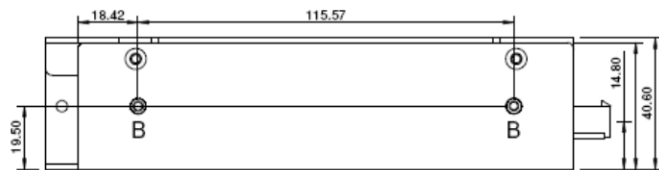
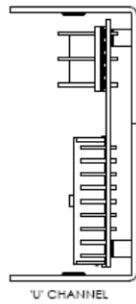
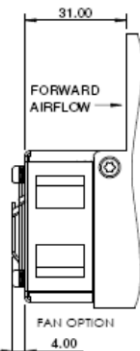
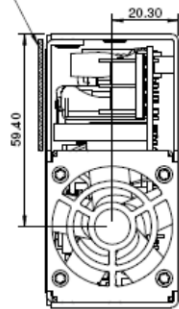

NOTE:

A 4 OFF HOLES Ø3.5mm CLEARANCE FOR M3 FIXINGS.  
 B 8 OFF FIXING HOLES FOR M3, MAXIMUM PENETRATION 4.5mm,  
 MAXIMUM TORQUE 0.5 -0.6Nm  
 ALL TOLERANCES +/-0.5mm

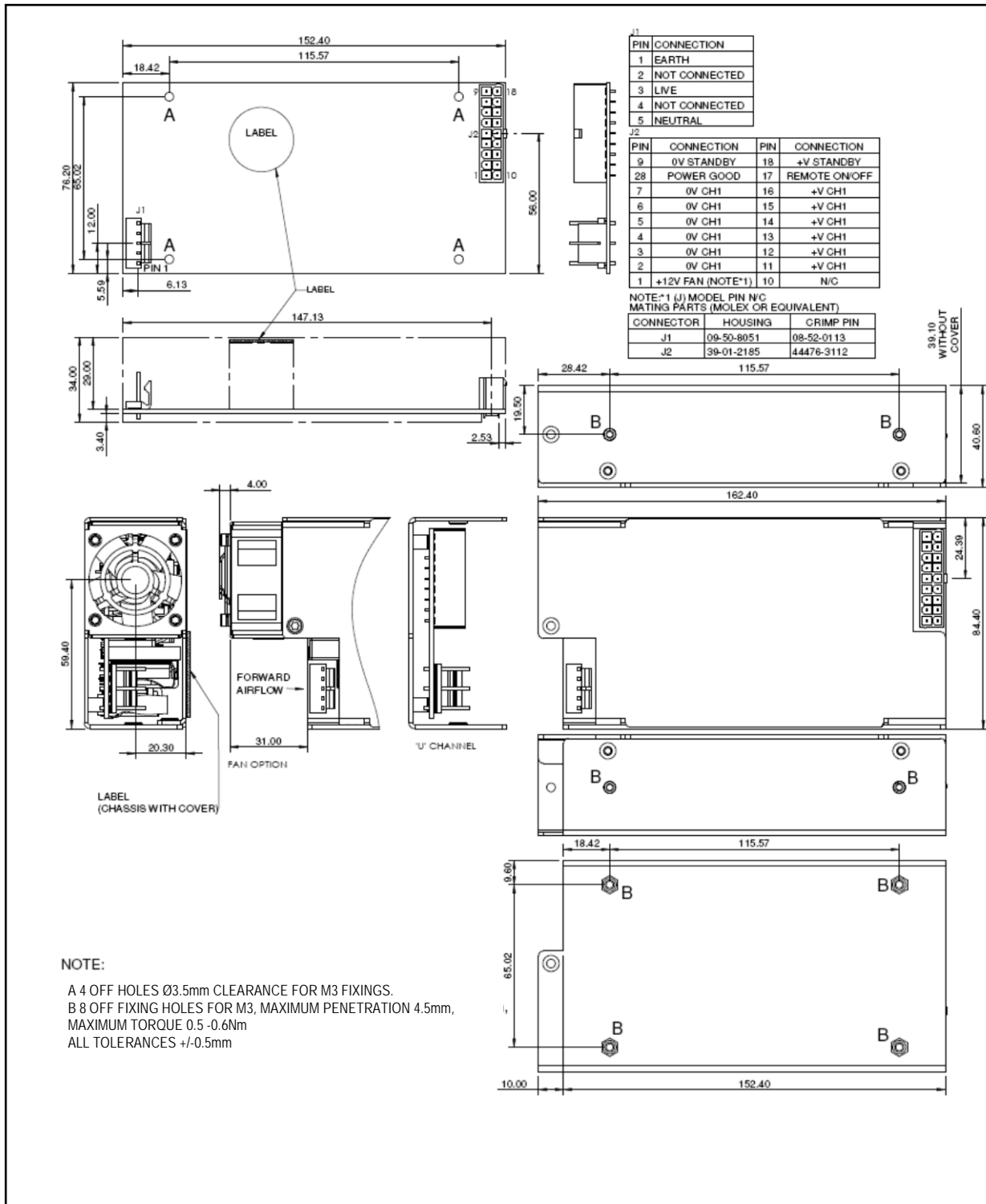



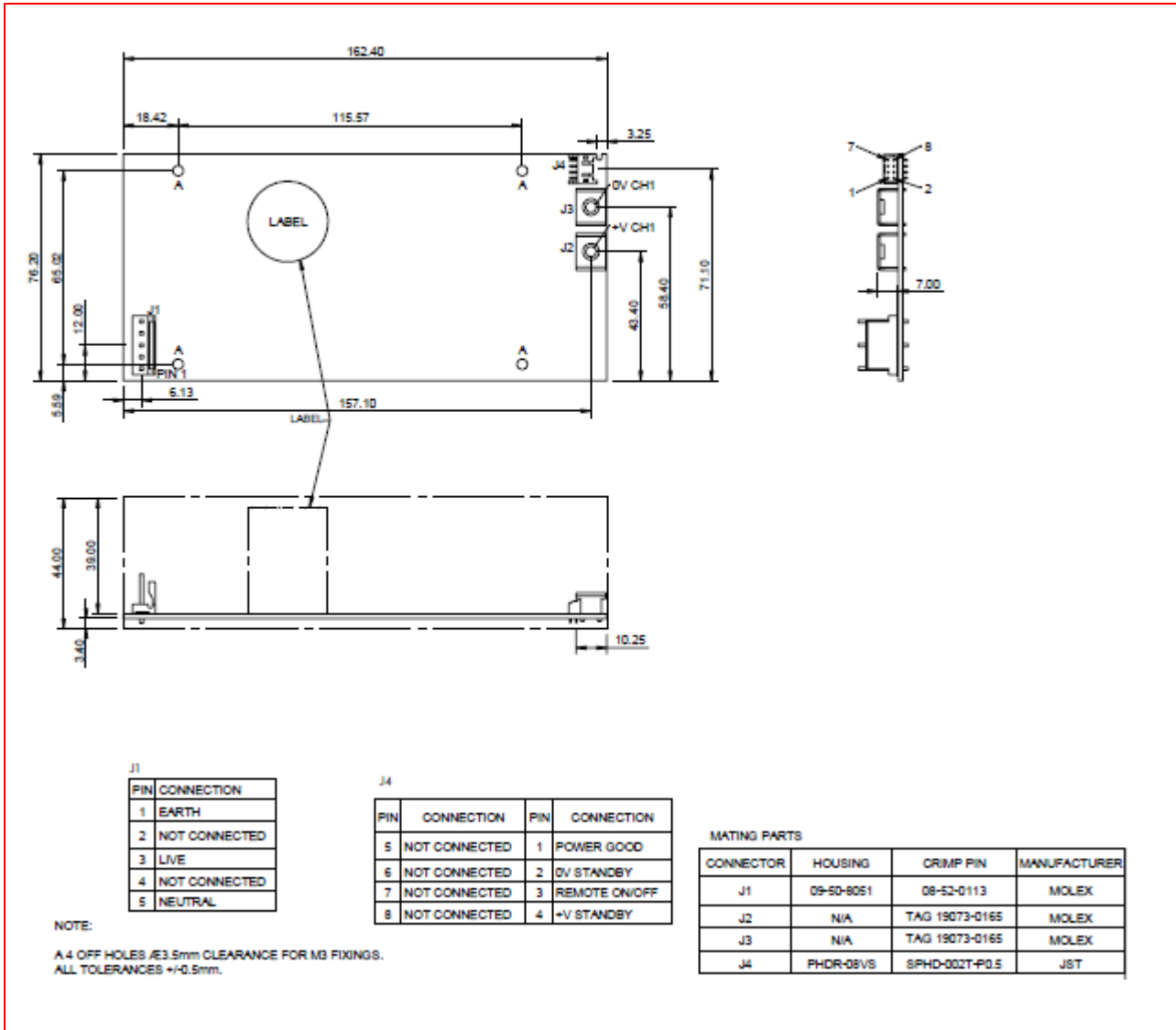

**TDK-Lambda**

TDK-Lambda UK Ltd  
 Kingsley Avenue, Ilfracombe  
 Devon, EX34 8ES  
 Telephone - Sales and Service +44 (0)1271 856666  
 Head Office and Works +44 (0)1271 856600  
 Facsimile +44 (0)1271 864894  
 WEBSITE: [www.uk.tdk-lambda.com](http://www.uk.tdk-lambda.com)