

PART No. 1485CRE

for more information visit
www.hammfg.com

Data subject to change without notice

Isometric drawing Not to Scale

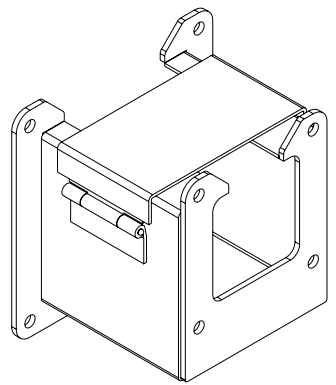

ISOMETRIC VIEW

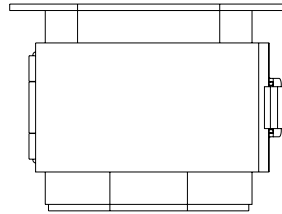

TOP VIEW

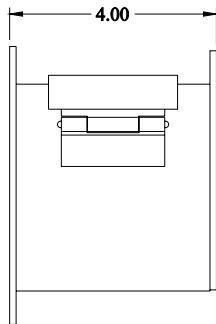

SIDE VIEW

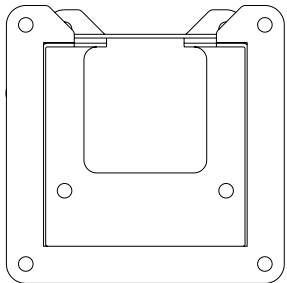

BACK VIEW

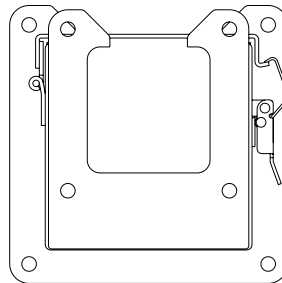

FRONT VIEW

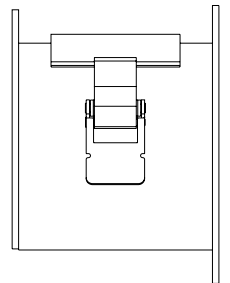

SIDE VIEW

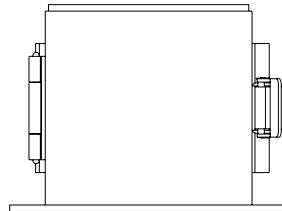

BOTTOM VIEW