

GlobTek, Inc. www.globtek.com 186 Veterans Drive, Northvale, NJ 07647 Tel. (201) 784-1000 Fax (201) 784-0111	Drawing Title: GT-83083-0505-USB-W2E, ITE Power Supply, Efficiency Level: VI, Case Color/Style: GlobTek Black, Wall Plug-in, AC/DC Switching Adapter with USB Power Supply AC Adaptor, Input Rating: 100-240V- , 50/60Hz, Euro Plug Fixed , Output Rating: 5W, 5V@1A, Output Configuration: N/A mm, N/A/4 Cond, N/A, Type "A" USB "JACK", integral to power supply enclosure, Ferrite: None, N/A, GT Cord # C0132, Pin Out: Pin 1: (+), Pin 2: Connected to Pin 3, Pin 3: Connected to Pin 2, Pin 4: (-); P2 and P3 are shorted together inside Power supply, Blades/Input Cord: Fixed Blades Europlug 2 pins, Class II; P/N: Q-EU(R), Approvals: CE Double Insulation GOST-R Level VI RoHS 2 Ukraine WEEE SIQ CB		
	Model No. GT-83083-0505-USB-W2E		
	Part No./Ordering No. WR9MA1000USB-F(R6B)		Rev C

REVISION HISTORY

REV	DESCRIPTION	SUB	DATE	APPROVED
C	Update pinout	QA	06/05/2015	QA
B	Update electrical specification, update packing, revise Level VI on title, add CB report	QA	04/02/2015	QA
A	Initial release	QA	03/24/2015	QA

In Addition to GlobTek Inc.'s renewed ISO9001:2008 - Quality Management System Certification, GlobTek Inc. is now certified to:

ISO13485:2003 - Medical Devices Quality Management System Certification
 ISO14001:2004 - Environmental Management System Certification

ISO Certificates are available online at <http://www.globtek.com/iso-certificates/>

Customer Approval of Specification:

Please approve, sign and send back to GlobTek so we can complete order processing.

A delay in receipt of this form will delay delivery schedule.

Company Name:

Customer P/N:

Quote Number:

Date:

Authorized Representative Name:

Authorized Representative Signature:

The acceptance of this specification and use of the product described in this document indicates the acceptance and binding of the customer to Globtek terms and conditions, which supersede all other agreements, terms, and conditions (<http://en.globtek.com/terms-and-conditions/>).

Footnote:

GlobTek Inc. will not be liable for the safety and performance of these power supplies if unauthorized access and repair occurs. End user should consult applicable UL, CSA or EN standards for proper installation instruction.

Limitation of Use:

GlobTek product are not authorized for use as mission critical components in life support hazardous environment, nuclear or aircraft applications without prior written approval from the CEO of GlobTek Inc.

Contents of this document are subject to change without prior notice.

GT-83083-0505-USB-W2E, 5W, 5V@1A, Wall Plug-in, AC/DC Switching Adapter with USB Power Supply AC Adaptor

GlobTek, Inc. www.globtek.com 186 Veterans Drive, Northvale, NJ 07647 Tel. (201) 784-1000 Fax (201) 784-0111	Drawing Title: GT-83083-0505-USB-W2E, ITE Power Supply, Efficiency Level: VI, Case Color/Style: GlobTek Black, Wall Plug-in, AC/DC Switching Adapter with USB Power Supply AC Adaptor, Input Rating: 100-240V- , 50/60Hz, Euro Plug Fixed , Output Rating: 5W, 5V@1A, Output Configuration: N/A mm, N/A/4 Cond, N/A, Type "A" USB "JACK", integral to power supply enclosure, Ferrite: None, N/A, GT Cord # C0132, Pin Out: Pin 1: (+), Pin 2: Connected to Pin 3, Pin 3: Connected to Pin 2, Pin 4: (-); P2 and P3 are shorted together inside Power supply, Blades/Input Cord: Fixed Blades Europlug 2 pins, Class II; P/N: Q-EU(R), Approvals: CE Double Insulation GOST-R Level VI RoHS 2 Ukraine WEEE SIQ CB	
	Model No. GT-83083-0505-USB-W2E	
	Part No./Ordering No. WR9MA1000USB-F(R6B)	Rev C

POWER SUPPLY INFORMATION

TYPE: Wall Plug-in
TECHNOLOGY: AC/DC Switching Adapter with USB Power Supply AC Adaptor
CASE COLOR: GlobTek Black
NAMEPLATE RATED INPUT: 100-240V- , 50/60Hz, 0.2A
INPUT CONFIG: Euro Plug Fixed
WATTS: 5.0
VOLTS OUT: 5
CURRENT OUT (Amps): 1
BLADE/CORD INCLUDED: FBEU:
BLADE/CORD INSTALLED: FBEU:
GROUNDING CONFIGURATION
EFFICIENCY LEVEL: VI
OUTPUT CONFIGURATION N/A mm, N/A/4 Cond, N/A, Type "A" USB "JACK", integral to power supply enclosure, Ferrite: None, N/A, GT Cord # C0132
CONNECTOR PIN OUT: Pin 1: (+), Pin 2: Connected to Pin 3, Pin 3: Connected to Pin 2, Pin 4: (-); P2 and P3 are shorted together inside Power supply
LABEL SPECS: Standard GT,L-1186
PACK SPEC: Standard with USB Jack, Individually Box

Notes/Modifications/Customizations (notes in this section supersede the values shown in the standard spec):

DIMENSIONS ARE IN MM UNLESS SPECIFIED OTHERWISE.

GlobTek, Inc. www.globtek.com 186 Veterans Drive, Northvale, NJ 07647 Tel. (201) 784-1000 Fax (201) 784-0111	Drawing Title: GT-83083-0505-USB-W2E, ITE Power Supply, Efficiency Level: VI, Case Color/Style: GlobTek Black, Wall Plug-in, AC/DC Switching Adapter with USB Power Supply AC Adaptor, Input Rating: 100-240V- , 50/60Hz, Euro Plug Fixed , Output Rating: 5W, 5V@1A, Output Configuration: N/A mm, N/A/4 Cond, N/A, Type "A" USB "JACK", integral to power supply enclosure, Ferrite: None, N/A, GT Cord # C0132, Pin Out: Pin 1: (+), Pin 2: Connected to Pin 3, Pin 3: Connected to Pin 2, Pin 4: (-); P2 and P3 are shorted together inside Power supply, Blades/Input Cord: Fixed Blades Europlug 2 pins, Class II; P/N: Q-EU(R), Approvals: CE Double Insulation GOST-R Level VI RoHS 2 Ukraine WEEE SIQ CB	
	Model No. GT-83083-0505-USB-W2E	
	Part No./Ordering No. WR9MA1000USB-F(R6B)	Rev C

ELECTRICAL SPECIFICATIONS

01. Input Voltage: Specified 90-264 Vac, Nameplate rated: 100-240Vac
02. Input Frequency: Specified 47-63 Hz, Nameplate rated 50-60Hz
03. Output Regulation: +/- 5% measured at the output connector measured at the end of a 0.6 meter USB cordset employing #22 Gauge conductors
04. Line Voltage Regulation: +/- 1% typical measured at the output connector measured at the end of a 0.6 meter USB cordset employing #22 Gauge conductors
05. Output Ripple (Vp-p): +/-1% or 100 mV whichever is greater measured at the end of a 0.6 meter USB cordset employing #22 Gauge conductors. Measured at 20 MHz bandwidth with 0.1 uf ceramic capacitor in parallel with 10 uf electrolytic capacitor connected at the end of the output connector.
06. Inrush Current: at full load, 25°C, cold start
07. Switching Frequency: 100 KHz typical, varies with line and load
08. Efficiency: 73.77% minimum at nominal input voltage average, Efficiency meet CEC , ERP2009/125/EC

B) PROTECTION

01. Over-current protection: 1.5A maximum with auto-recovery function
02. Over-voltage protection: 10VDC maximum with zener clamp
03. Short-circuit protection: The adapter shall not be damaged by short the DC output to Ground.

C) SAFETY

01. Dielectric Withstand Voltage: Primary To Secondary: 3000VAC 10mA 1minute or 4242VDC 10mA 1minute
02. Leakage Current: 20uA maximum, at nominal AC input voltage and frequency
03. ESD Immunity per EN61000-4-2, ±8 kV contact, ±15 kV air, Perf Criteria A Standard.

D) OTHER:

01. MTBF: 200,000 Hours @ 25°C ambient temperature
02. Operating Temperature: 0°C to 50°C ambient temperature
03. Operating Humidity: 20 ~ 85 % RH. non-condensing
05. Storage Temperature: -20°C to 60°C
06. Storage Humidity: 5 ~ 95 % RH. non-condensing
07. Cooling: Cooling shall be with natural convection cooling
08. RoHS 2: Complies with EU 2011/65/EU China SJ/T 11364-2014

E) ENCLOSURE

01. Housing: High impact plastic, 94V0 polycarbonate, non-vented

PROPRIETARY INFORMATION

PROPRIETARY OF GLOBTEK, INC. ANY REPRODUCTION, DISCLOSURE OR USE OF THIS DRAWING, IN WHOLE OR IN PART, IS HEREBY PROHIBITED EXCEPT AS SPECIFIED IN

WRITING BY GLOBTEK, INC.

quest /08/20/2018 7:42:30 AM

GlobTek, Inc.
www.globtek.com
186 Veterans Drive,
Northvale, NJ 07647
Tel. (201) 784-1000
Fax (201) 784-0111

Drawing Title: GT-83083-0505-USB-W2E, ITE Power Supply, Efficiency Level: VI, Case Color/Style: GlobTek Black, Wall Plug-in, AC/DC Switching Adapter with USB Power Supply AC Adaptor, Input Rating: 100-240V- , 50/60Hz, Euro Plug Fixed , Output Rating: 5W, 5V@1A, Output Configuration: N/A mm, N/A/4 Cond, N/A, Type "A" USB "JACK", integral to power supply enclosure, Ferrite: None, N/A, GT Cord # C0132, Pin Out: Pin 1: (+), Pin 2: Connected to Pin 3, Pin 3: Connected to Pin 2, Pin 4: (-); P2 and P3 are shorted together inside Power supply, Blades/Input Cord: Fixed Blades Europlug 2 pins, Class II; P/N: Q-EU(R), Approvals: CE Double Insulation GOST-R Level VI RoHS 2 Ukraine WEEE SIQ CB

Model No. GT-83083-0505-USB-W2E

Part No./Ordering No. WR9MA1000USB-F(R6B)

Rev C

02. Markings: Label and/or Pad Printed and/or Molded in the case

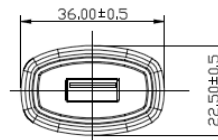
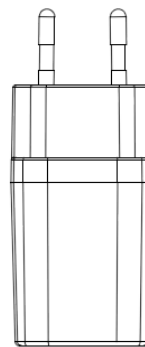
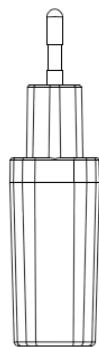
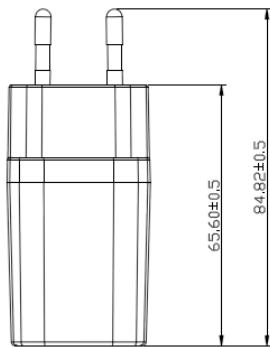
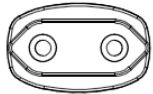

GlobTek, Inc. www.globtek.com 186 Veterans Drive, Northvale, NJ 07647 Tel. (201) 784-1000 Fax (201) 784-0111	Drawing Title: GT-83083-0505-USB-W2E, ITE Power Supply, Efficiency Level: VI, Case Color/Style: GlobTek Black, Wall Plug-in, AC/DC Switching Adapter with USB Power Supply AC Adaptor, Input Rating: 100-240V~, 50/60Hz, Euro Plug Fixed, Output Rating: 5W, 5V@1A, Output Configuration: N/A mm, N/A/4 Cond, N/A, Type "A" USB "JACK", integral to power supply enclosure, Ferrite: None, N/A, GT Cord # C0132, Pin Out: Pin 1: (+), Pin 2: Connected to Pin 3, Pin 3: Connected to Pin 2, Pin 4: (-); P2 and P3 are shorted together inside Power supply, Blades/Input Cord: Fixed Blades Europlug 2 pins, Class II; P/N: Q-EU(R), Approvals: CE Double Insulation GOST-R Level VI RoHS 2 Ukraine WEEE SIQ CB	
	Model No. GT-83083-0505-USB-W2E	
	Part No./Ordering No. WR9MA1000USB-F(R6B)	Rev C

INPUT CONFIGURATION

Blades/Cord Included: FBEU:

Blades/Cord Installed: FBEU:

European CEE 7/16 configuration: Europlug 2 PIN

The prongs of the Europlug are 19 mm long. They consist of a 9 mm long conductive tip of 4 mm diameter with a rounded ending, followed by a 10 mm long flexible insulated shaft of not more than 3.8 mm diameter. The two prongs are not exactly parallel and converge slightly; their centres are 19 mm apart at the tip and 18.6 mm apart at the base. The elasticity of the converging prongs provides sufficient contact force for the Europlug's current rating with a variety of socket-hole arrangements. The entire plug is 35.3 mm wide and 13.7 mm high, and must not exceed these dimensions within 18 mm behind its front plane (this allows for the recesses on many European socket types). The left and right side of the plug are formed by surfaces that are at 45° relative to the horizontal plan.

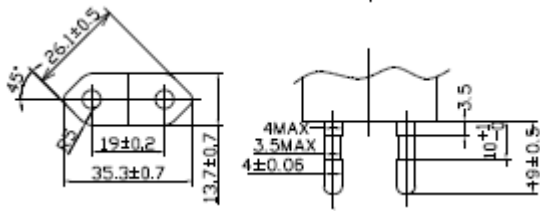

GlobTek, Inc. www.globtek.com 186 Veterans Drive, Northvale, NJ 07647 Tel. (201) 784-1000 Fax (201) 784-0111	Drawing Title: GT-83083-0505-USB-W2E, ITE Power Supply, Efficiency Level: VI, Case Color/Style: GlobTek Black, Wall Plug-in, AC/DC Switching Adapter with USB Power Supply AC Adaptor, Input Rating: 100-240V- , 50/60Hz, Euro Plug Fixed , Output Rating: 5W, 5V@1A, Output Configuration: N/A mm, N/A/4 Cond, N/A, Type "A" USB "JACK", integral to power supply enclosure, Ferrite: None, N/A, GT Cord # C0132, Pin Out: Pin 1: (+), Pin 2: Connected to Pin 3, Pin 3: Connected to Pin 2, Pin 4: (-); P2 and P3 are shorted together inside Power supply, Blades/Input Cord: Fixed Blades Europlug 2 pins, Class II; P/N: Q-EU(R), Approvals: CE Double Insulation GOST-R Level VI RoHS 2 Ukraine WEEE SIQ CB	
	Model No. GT-83083-0505-USB-W2E	
	Part No./Ordering No. WR9MA1000USB-F(R6B)	Rev C

OUTPUT CORD AND CONNECTOR: USBMT/C0132

ACTUAL CONNECTORS, OVERMOLDS, FERRITES MAY VARY SLIGHTLY FROM THE PICTURE BELOW

CABLE TYPE	N/A
CABLE LENGTH (mm)	N/A
CABLE TOLERANCE (mm)	N/A
WIRE GAUGE (AWG)	N/A
CONDUCTORS	4
HANK DIMENSION (mm)	N/A
CABLE / CONNECTOR OVERMOLD COLOR	N/A
FERRITE TYPE / DIMENSION	None
FERRITE # OF TURNS (Definition)	N/A
FERRITE DIMENSION FROM STRAIN RELIEF	N/A
FERRITE DIMENSION FROM PLUG	N/A
PLUG TYPE	Type "A" USB "JACK", integral to power supply enclosure
OVER MOLD ORIENTATION	PCB Mount Connector
CONNECTOR PIN OUT:	Pin 1: (+), Pin 2: Connected to Pin 3, Pin 3: Connected to Pin 2, Pin 4: (-); P2 and P3 are shorted together inside Power supply
ADDITIONAL REQUIREMENTS	

Front View

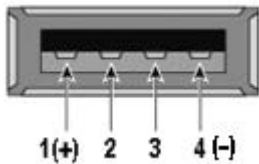

ADDITIONAL OUTPUT PLUG OPTIONS ARE AVAILABLE AT <http://www.globtek.com/connectors/>
 STANDARD PLUGS AND CONNECTORS CAN BE SEEN ONLINE AT <http://www.globtek.com/connectors/>

GlobTek, Inc. www.globtek.com 186 Veterans Drive, Northvale, NJ 07647 Tel. (201) 784-1000 Fax (201) 784-0111	Drawing Title: GT-83083-0505-USB-W2E, ITE Power Supply, Efficiency Level: VI, Case Color/Style: GlobTek Black, Wall Plug-in, AC/DC Switching Adapter with USB Power Supply AC Adaptor, Input Rating: 100-240V- , 50/60Hz, Euro Plug Fixed , Output Rating: 5W, 5V@1A, Output Configuration: N/A mm, N/A/4 Cond, N/A, Type "A" USB "JACK", integral to power supply enclosure, Ferrite: None, N/A, GT Cord # C0132, Pin Out: Pin 1: (+), Pin 2: Connected to Pin 3, Pin 3: Connected to Pin 2, Pin 4: (-); P2 and P3 are shorted together inside Power supply, Blades/Input Cord: Fixed Blades Europlug 2 pins, Class II; P/N: Q-EU(R), Approvals: CE Double Insulation GOST-R Level VI RoHS 2 Ukraine WEEE SIQ CB	
	Model No. GT-83083-0505-USB-W2E	
	Part No./Ordering No. WR9MA1000USB-F(R6B)	Rev C

LABEL:L-1186

LABEL P/N: Standard GT
 MATERIAL: Flat Thermal Transfer, Imprintable, Polyester Label and/or Pad Printed and/or Molded, and/or Laser Engraved in the case
 BACKGROUND COLOR: Black if housing is Black, White or Silver if housing is White or Gray.
 TEXT COLOR: White or Silver if label is Black Background for Black housing. Black if label is White or Silver background and Housing is White or Gray
 LABEL WIDTH (mm): 30.0
 LABEL HEIGHT (mm): 24.0

Below is the minimum information which will appear on the label. NOTE: in the logo area additional/actual positioning of symbols and text is subjected to change as per agency updates/requirements or additional model approvals become available. Regulatory certifications/label markings may be in logo area on the label or molded into the case housing outside the label area. Information will be shown via label and/or pad printed and/or molded and/or laser engraved in the case. * Date code markings at GlobTek option.

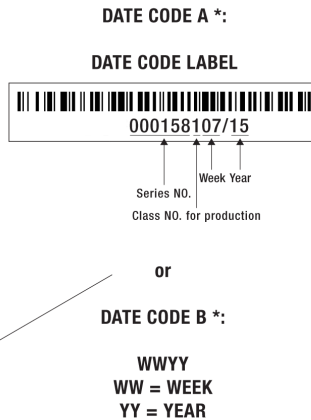

A=ITE Power Supply
 B=P/N: (料号) WR9MA1000USB-F(R6B)
 C=Model (型号) GT-83083-0505-USB-W2E
 D=Input (输入) 100-240V- , 50/60Hz, 0.2A
 E=Output (输出) 5 V \equiv 1 A , 5.0W

- AGENCY ONLINE DOCUMENTS <http://www.globtek.info/certs/GT-83083-USB-W2Z/>
- CE EC-Declaration for Medical [Contact GlobTek for more information](#)
- CE EC-Declaration for Industrial/Commercial/ITE http://www.globtek.com/pdf/ec_declaration/a0Oa000000MEmx4EAD
- RoHS/RoHS2 Declaration http://www.globtek.com/pdf/rohs_cert/01ta00000055rpeAAA
- REACH Declaration http://www.globtek.com/pdf/iso_certificates/REACH.pdf

GlobTek, Inc. www.globtek.com 186 Veterans Drive, Northvale, NJ 07647 Tel. (201) 784-1000 Fax (201) 784-0111	Drawing Title: GT-83083-0505-USB-W2E, ITE Power Supply, Efficiency Level: VI, Case Color/Style: GlobTek Black, Wall Plug-in, AC/DC Switching Adapter with USB Power Supply AC Adaptor, Input Rating: 100-240V- , 50/60Hz, Euro Plug Fixed , Output Rating: 5W, 5V@1A, Output Configuration: N/A mm, N/A/4 Cond, N/A, Type "A" USB "JACK", integral to power supply enclosure, Ferrite: None, N/A, GT Cord # C0132, Pin Out: Pin 1: (+), Pin 2: Connected to Pin 3, Pin 3: Connected to Pin 2, Pin 4: (-); P2 and P3 are shorted together inside Power supply, Blades/Input Cord: Fixed Blades Europlug 2 pins, Class II; P/N: Q-EU(R), Approvals: CE Double Insulation GOST-R Level VI RoHS 2 Ukraine WEEE SIQ CB	
	Model No. GT-83083-0505-USB-W2E	
	Part No./Ordering No. WR9MA1000USB-F(R6B)	Rev C

Conflict Minerals Declaration

<http://www.globtek.com/pdf/conflict-minerals.pdf>

IPXY rating is based on 3rd party testing and customers should check suitability and test system level IPXY rating before ordering.

Regulatory Certifications/Label Markings

LATEST PRODUCT/MODEL CERTIFICATIONS: <http://en.globtek.com/datasheet/id/a00a000000MEmx4>

AGENCY ONLINE DOCUMENTS: <http://www.globtek.info/certs/GT-83083-USB-W2Z/>

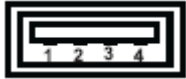

Pin 1: (+), Pin 2: Connected to Pin 3, Pin 3: Connected to Pin 2, Pin 4: (-); P2 and P3 are shorted together inside Power supply

GlobTek, Inc. www.globtek.com 186 Veterans Drive, Northvale, NJ 07647 Tel. (201) 784-1000 Fax (201) 784-0111	Drawing Title: GT-83083-0505-USB-W2E, ITE Power Supply, Efficiency Level: VI, Case Color/Style: GlobTek Black, Wall Plug-in, AC/DC Switching Adapter with USB Power Supply AC Adaptor, Input Rating: 100-240V- , 50/60Hz, Euro Plug Fixed , Output Rating: 5W, 5V@1A, Output Configuration: N/A mm, N/A/4 Cond, N/A, Type "A" USB "JACK", integral to power supply enclosure, Ferrite: None, N/A, GT Cord # C0132, Pin Out: Pin 1: (+), Pin 2: Connected to Pin 3, Pin 3: Connected to Pin 2, Pin 4: (-); P2 and P3 are shorted together inside Power supply, Blades/Input Cord: Fixed Blades Europlug 2 pins, Class II; P/N: Q-EU(R), Approvals: CE Double Insulation GOST-R Level VI RoHS 2 Ukraine WEEE SIQ CB	
	Model No. GT-83083-0505-USB-W2E	
	Part No./Ordering No. WR9MA1000USB-F(R6B)	Rev C

PACKAGING

Packing Spec P/N: Standard with USB Jack, Individually Box

Box Qty: 360

Gift Box Size (mm): 42(L)*28(W)*91(H)

Gift Box Color: White

Master Carton Size (mm): 445*305*305

Master GW (Kg): 21.0 kg

BLADES INCLUDED: FBEU:

BLADE/CORD INSTALLED: FBEU:

If specific packaging is required, this section must specify all requirements and note "no exceptions". If this section does not specify packaging, it is subject to change without notice at GlobTek's discretion

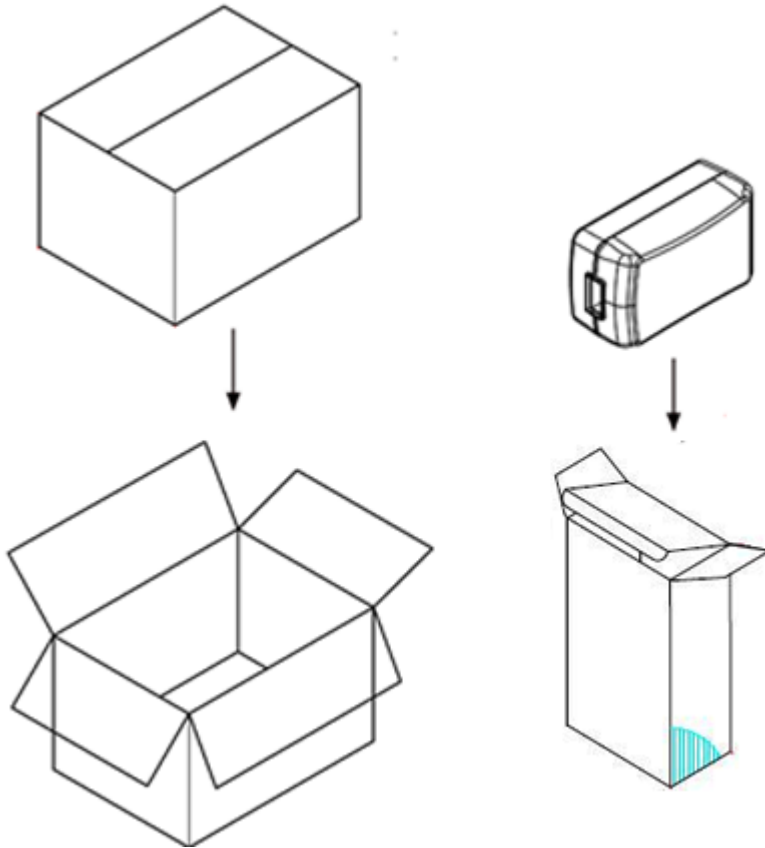

GlobTek, Inc. www.globtek.com 186 Veterans Drive, Northvale, NJ 07647 Tel. (201) 784-1000 Fax (201) 784-0111	Drawing Title: GT-83083-0505-USB-W2E, ITE Power Supply, Efficiency Level: VI, Case Color/Style: GlobTek Black, Wall Plug-in, AC/DC Switching Adapter with USB Power Supply AC Adaptor, Input Rating: 100-240V- , 50/60Hz, Euro Plug Fixed , Output Rating: 5W, 5V@1A, Output Configuration: N/A mm, N/A/4 Cond, N/A, Type "A" USB "JACK", integral to power supply enclosure, Ferrite: None, N/A, GT Cord # C0132, Pin Out: Pin 1: (+), Pin 2: Connected to Pin 3, Pin 3: Connected to Pin 2, Pin 4: (-); P2 and P3 are shorted together inside Power supply, Blades/Input Cord: Fixed Blades Europlug 2 pins, Class II; P/N: Q-EU(R), Approvals: CE Double Insulation GOST-R Level VI RoHS 2 Ukraine WEEE SIQ CB	
	Model No. GT-83083-0505-USB-W2E	
	Part No./Ordering No. WR9MA1000USB-F(R6B)	Rev C

INSTRUCTION SHEET

N/A