

User Manual

Anybus[®] X-gateway Modbus-TCP PROFIBUS DP-V1

Doc.Id. HMSI-168-46
Rev. 1.10

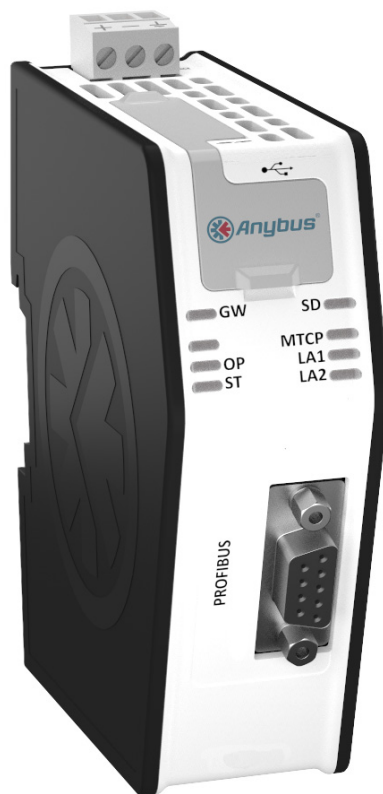

HALMSTAD • CHICAGO • KARLSRUHE • TOKYO • BEIJING • MILANO • MULHOUSE • COVENTRY • PUNE • COPENHAGEN

HMS Industrial Networks
Mailing address: Box 4126, 300 04 Halmstad, Sweden
Visiting address: Stationsgatan 37, Halmstad, Sweden

E-mail: info@hms-networks.com
Web: www.anybus.com

Important User Information

This document is intended to provide a good understanding of the functionality offered by the Anybus X-gateway Modbus-TCP - PROFIBUS DP-V1. The reader of this document is expected to be familiar with high level software design, and communication systems in general.

Liability

Every care has been taken in the preparation of this manual. Please inform HMS Industrial Networks AB of any inaccuracies or omissions. The data and illustrations found in this document are not binding. We, HMS Industrial Networks AB, reserve the right to modify our products in line with our policy of continuous product development. The information in this document is subject to change without notice and should not be considered as a commitment by HMS Industrial Networks AB. HMS Industrial Networks AB assumes no responsibility for any errors that may appear in this document.

There are many applications of this product. Those responsible for the use of this device must ensure that all the necessary steps have been taken to verify that the applications meet all performance and safety requirements including any applicable laws, regulations, codes, and standards.

HMS Industrial Networks AB will under no circumstances assume liability or responsibility for any problems that may arise as a result from the use of undocumented features, timing, or functional side effects found outside the documented scope of this product. The effects caused by any direct or indirect use of such aspects of the product are undefined, and may include e.g. compatibility issues and stability issues.

The examples and illustrations in this document are included solely for illustrative purposes. Because of the many variables and requirements associated with any particular implementation, HMS Industrial Networks AB cannot assume responsibility for actual use based on these examples and illustrations.

Intellectual Property Rights

HMS Industrial Networks AB has intellectual property rights relating to technology embodied in the product described in this document. These intellectual property rights may include patents and pending patent applications in the US and other countries.

Trademark Acknowledgements

Anybus ® is a registered trademark of HMS Industrial Networks AB. All other trademarks are the property of their respective holders.

<p>Warning: This is a class A product. in a domestic environment this product may cause radio interference in which case the user may be required to take adequate measures.</p> <p>ESD Note: This product contains ESD (Electrostatic Discharge) sensitive parts that may be damaged if ESD control procedures are not followed. Static control precautions are required when handling the product. Failure to observe this may cause damage to the product.</p> <p>Warning: DO NOT USE SD CARD OR USB CONNECTOR WHILE CIRCUIT IS LIVE UNLESS THE AREA IS KNOWN TO BE FREE OF IGNITABLE CONCENTRATIONS OF FLAMMABLE GAS OR VAPORS.</p>
--

Table of Contents

Preface	About This Document	5
	Related Documents.....	5
	Document History	5
	Conventions & Terminology.....	6
	Sales and Support	7
Chapter 1	Getting Started	8
Chapter 2	Anybus X-gateway Modbus-TCP	9
	Introduction	9
	Features.....	10
	Configuring the PROFIBUS DP-V1 Network	10
	PROFIBUS DP-V1 GSD-file	10
	Functional Overview	11
	Data Exchange.....	12
	I/O Mapped Data.....	13
	Parameter Data	13
	Control/Status Word.....	13
	Live List	14
	Transaction status List.....	15
	Exception Code List	16
Chapter 3	About the Anybus X-gateway Modbus-TCP	17
	External View	17
	Mounting the X-gateway	18
	<i>DIN-rail Mounting</i>	18
	<i>Wall Mounting</i>	19
	Status LEDs	20
	PROFIBUS DP-V1 Connector	21
	USB Connector.....	21
	Modbus-TCP Connectors.....	21
	Power Connector	22

Chapter 4	SD Card Functionality	23
	General Advice and Guidelines	23
	Starting Up	23
	Easy Backup	24
	Simple Configuration Copy	24
	Easy Replacement	24
	SD Card Synchronization Failure	25
Chapter 5	Modbus-TCP Functions	26
Chapter 6	Network Configuration	27
	General Information	27
	Introduction	28
	Overview	29
	<i>Home</i>	30
	Configuration	31
	<i>Authentication</i>	31
	<i>Modbus Client</i>	32
	<i>Modbus Servers</i>	33
	<i>PROFIBUS DP-V1 (Slave Interface)</i>	36
	Tools	37
	<i>X-gateway Management</i>	37
	<i>Backup and Restore</i>	37
	<i>Mapping Overview</i>	38
	<i>Mapping Overview Example</i>	39
	<i>Transaction Monitor</i>	40
Appendix A	Technical Specification	41
	Protective Earth (PE) Requirements	41
	Power Supply	41
	Environmental Specification	41
	<i>Temperature</i>	41
	<i>Relative Humidity</i>	41
	EMC (CE) Compliance	42
Appendix B	Anybus IPconfig Tool	43
Appendix C	Copyright Notices	44

P. About This Document

For more information, documentation etc., please visit the HMS website, www.anybus.com.

P.1 Related Documents

Document	Author
Modbus Application Protocol Specification V1.1B	Modbus Organization

P.2 Document History

Summary of Recent Changes (1.01... 1.10)

Change	Page(s)
Updated information about data exchange to reflect the parameter data features	12
Added information about I/O mapped data and parameter data	13
Added information about the transaction status list	15
Added information about the exception code list	16
Added information about the identification LED sequence	20
Added available Modbus functions	26
Updated the configuration web pages to reflect new and revised functionality	27
Updated information about the Anybus IPconfig tool	43

Revision List

Revision	Date	Author(s)	Chapter(s)	Description
1.00	2011-04-26	KaD	-	First official release
1.01	2011-06-28	KaD	4, 6, B	Added chapter 4, minor corrections and updates
1.10	2012-11-21	KaD	2, 3, 5, 6, B	Major update

P.3 Conventions & Terminology

The following conventions are used throughout this manual:

- Numbered lists provide sequential steps
- Bulleted lists provide information, not procedural steps
- The terms 'Anybus', 'X-gateway' or 'module' refers to the Anybus X-gateway module
- Hexadecimal values are written in the format NNNNh, where NNNN is the hexadecimal value
- A byte always consists of 8 bits
- The terms 'master', 'scanner', 'client' and 'controller' will be used interchangeably to describe a controlling unit on the network
- The terms 'slave', 'adapter', 'server' and 'device' will be used interchangeably to describe units that are controlled by controlling units on the network

P.4 Sales and Support

Sales		Support	
HMS Sweden (Head Office)			
E-mail:	sales@hms.se	E-mail:	support@hms.se
Phone:	+46 (0) 35 - 17 29 56	Phone:	+46 (0) 35 - 17 29 20
Fax:	+46 (0) 35 - 17 29 09	Fax:	+46 (0) 35 - 17 29 09
Online:		Online:	www.anybus.com
HMS North America			
E-mail:	us-sales@hms-networks.com	E-mail:	us-support@hms-networks.com
Phone:	+1-312 - 829 - 0601	Phone:	+1-312-829-0601
Toll Free:	+1-888-8-Anybus	Toll Free:	+1-888-8-Anybus
Fax:	+1-312-629-2869	Fax:	+1-312-629-2869
Online:		Online:	www.anybus.com
HMS Germany			
E-mail:	ge-sales@hms-networks.com	E-mail:	ge-support@hms-networks.com
Phone:	+49 (0) 721-96472-0	Phone:	+49 (0) 721-96472-0
Fax:	+49 (0) 721-96472-10	Fax:	+49 (0) 721-96472-10
Online:	www.anybus.de	Online:	www.anybus.de
HMS Japan			
E-mail:	jp-sales@hms-networks.com	E-mail:	jp-support@hms-networks.com
Phone:	+81 (0) 45-478-5340	Phone:	+81 (0) 45-478-5340
Fax:	+81 (0) 45-476-0315	Fax:	+81 (0) 45-476-0315
Online:	www.anybus.jp	Online:	www.anybus.jp
HMS China			
E-mail:	cn-sales@hms-networks.com	E-mail:	cn-support@hms-networks.com
Phone:	+86 (0) 10-8532-3183	Phone:	+86 (0) 10-8532-3023
Fax:	+86 (0) 10-8532-3209	Fax:	+86 (0) 10-8532-3209
Online:	www.anybus.cn	Online:	www.anybus.cn
HMS Italy			
E-mail:	it-sales@hms-networks.com	E-mail:	it-support@hms-networks.com
Phone:	+39 039 59662 27	Phone:	+39 039 59662 27
Fax:	+39 039 59662 31	Fax:	+39 039 59662 31
Online:	www.anybus.it	Online:	www.anybus.it
HMS France			
E-mail:	fr-sales@hms-networks.com	E-mail:	fr-support@hms-networks.com
Phone:	+33 (0) 3 68 368 034	Phone:	+33 (0) 3 68 368 033
Fax:	+33 (0) 3 68 368 031	Fax:	+33 (0) 3 68 368 031
Online:	www.anybus.fr	Online:	www.anybus.fr
HMS UK & Eire			
E-mail:	uk-sales@anybus.co.uk	E-mail:	support@hms-networks.com
Phone:	+44 (0) 1926 405599	Phone:	+46 (0) 35 - 17 29 20
Fax:	+44 (0) 1926 405522	Fax:	+46 (0) 35 - 17 29 09
Online:	www.anybus.co.uk	Online:	www.anybus.com
HMS Denmark			
E-mail:	info@anybus.dk	E-mail:	support@hms-networks.com
Phone:	+45 (0) 22 30 08 01	Phone:	+46 (0) 35 - 17 29 20
Fax:	+46 (0) 35 17 29 09	Fax:	+46 (0) 35 - 17 29 09
Online:	www.anybus.com	Online:	www.anybus.com
HMS India			
E-mail:	in-sales@anybus.com	E-mail:	in-support@hms-networks.com
Phone:	+91 (0) 20 40111201	Phone:	+46 (0) 35 - 17 29 20
Fax:	+91 (0) 20 40111105	Fax:	+46 (0) 35 - 17 29 09
Online:	www.anybus.com	Online:	www.anybus.com

1. Getting Started

The purpose of this chapter is to give a short description on how to install the X-gateway and get it up and running, transferring I/O data between the Modbus-TCP network and the PROFIBUS DP-V1 network.

Perform the following steps when installing the module:

1. Mount the module. See “Mounting the X-gateway” on page 18 for details.
2. Connect the X-gateway to the Modbus-TCP network. See “External View” on page 17.
3. Connect the power cable and apply power.
4. Access the configuration web pages.
 - Connect a PC to the Modbus-TCP network (see “External View” on page 17) and open a web browser. Enter the IP address of the X-gateway and access the configuration web pages. If the IP address of the X-gateway is unknown, use the Anybus IPconfig tool to find it. See “Anybus IPconfig Tool” on page 43.
 - Configure the Modbus-TCP client. See “Modbus Client” on page 32.
 - Set up all Modbus servers and transactions using the configuration web pages. See “Modbus Servers” on page 33 and “Network Configuration” on page 27.
 - Configure the X-gateway slave interface. See “PROFIBUS DP-V1 (Slave Interface)” on page 36.
5. Download the appropriate GSD file from www.anybus.com. See “PROFIBUS DP-V1 GSD-file” on page 10.
6. Configure the PROFIBUS DP-V1 master. See “Configuring the PROFIBUS DP-V1 Network” on page 10.
7. Connect the X-gateway to the PROFIBUS DP-V1 network. See “External View” on page 17.

2. Anybus X-gateway Modbus-TCP

2.1 Introduction

The Anybus X-gateway Modbus-TCP is a series of network gateways, used to provide a seamless connection between a Modbus-TCP network and a controlling network. This particular product connects a Modbus-TCP network to a PROFIBUS DP-V1 network. The X-gateway enables the master of the PROFIBUS DP-V1 network to control the Modbus-TCP network. These X-gateways makes it possible to integrate Modbus-TCP devices into almost any other PLC system and their supported networks.

The X-gateway is based on patented Anybus technology, a proven industrial communication solution used all over the world by leading manufacturers of industrial automation products. Each module offers Modbus-TCP master connectivity to one of these industrial networks: EtherNet/IP, CC-Link, Modbus RTU, Modbus-TCP, ControlNet, PROFINET, CANopen, EtherCAT, DeviceNet and PROFIBUS DP-V1.

No proprietary configuration software is needed. All necessary configuration is made via the built-in web interface.

The PROFIBUS DP-V1 fieldbus slave interface is configured with a standard Generic Station Description file (GSD) and the standard engineering tool of the PLC. No programming is required.

The X-gateway transmits I/O data transparently between the two networks.

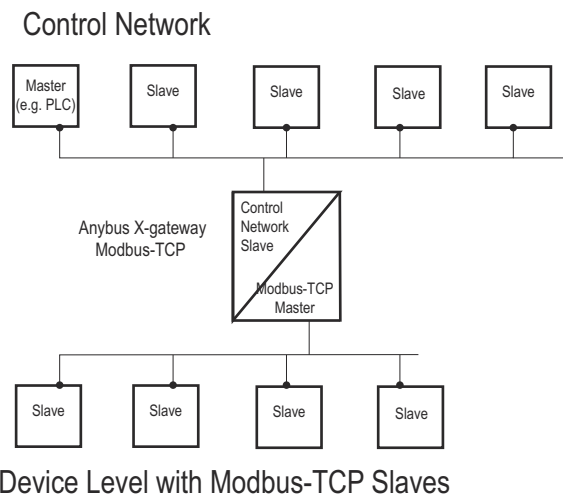

2.2 Features

Anybus X-gateways for Modbus-TCP act as intelligent links between two industrial networks. On the Modbus-TCP network, they function as clients (masters) while they function as slaves on the PROFIBUS DP-V1 network. The implementation is based on the Anybus NP30 ASIC technology.

2.3 Configuring the PROFIBUS DP-V1 Network

The Anybus X-gateway Modbus-TCP is a PROFIBUS DP-V1 slave on the PROFIBUS DP-V1 network. The general settings for the adapter interface are configured using the configuration web pages (see “PROFIBUS DP-V1 (Slave Interface)” on page 36). All data transfers must be configured using the PROFIBUS DP-V1 configuration tool. Please note that the size of the I/O data that can be read from and written to the module is defined when configuring the X-gateway using the configuration web pages.

There are a number of different configuration tools for PROFIBUS DP-V1 available on the market. The choice of tool depends on the application and the PROFIBUS DP-V1 master of the network. A .GSD file for the slave interface is available at ‘www.anybus.com’.

An application note, describing how to configure an Anybus PROFIBUS DP-V1 slave interface with Siemens STEP7, is available on the support pages for the Anybus X-gateway Modbus-TCP - PROFIBUS DP-V1 module at ‘www.anybus.com’.

2.4 PROFIBUS DP-V1 GSD-file

Each device in a PROFIBUS DP-V1 network is associated with a Generic Station Description file (a GSD file), which describes the implementation of the product. This file is used by the network configuration tool during network configuration.

The latest version of the GSD file for the Anybus X-gateway PROFIBUS DP-V1 interface can be downloaded from the HMS website, ‘www.anybus.com’.

2.5 Functional Overview

Internally, the X-gateway consists of an intelligent gateway platform, an Anybus Modbus-TCP interface and an Anybus PROFIBUS DP-V1 (slave) interface. The Modbus-TCP interface and the Anybus PROFIBUS DP-V1 (slave) interface are interconnected through the intelligent gateway platform, which basically forwards data from one network to the other and vice versa as shown below. This design allows almost any other industrial network to be connected to a Modbus-TCP master on a separate Modbus-TCP network.

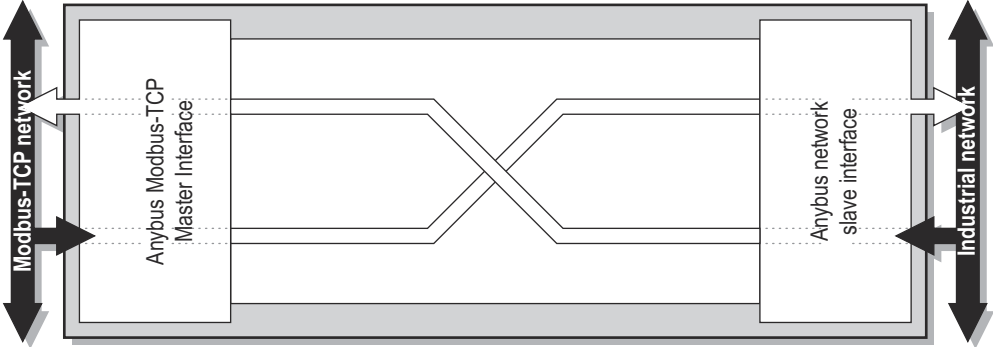

2.6 Data Exchange

Each of the two network interfaces exchanges data on its network through two buffers. The X-gateway forwards the data between these buffers as shown below. Note that this process is separated from the network data exchange. While the X-gateway ensures data consistency (where applicable), it does not feature any built-in mechanisms for synchronization between the Modbus-TCP network and the PROFIBUS DP-V1 network.

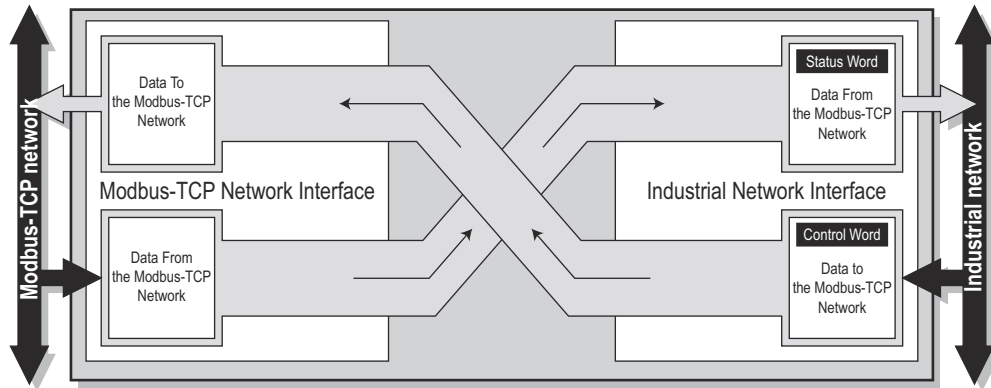

Each data buffer holds a maximum of 256 bytes of data, and the total amount of data that can be exchanged at any time cannot exceed 512 bytes. The first two I/O mapped bytes in either direction can be dedicated for control/status information, and another eight bytes of data coming from the Modbus-TCP network can feature a live list.

Through the dedicated control word, the master on the PROFIBUS DP-V1 network starts/stops the exchange of data on the Modbus-TCP network, and also resets the X-gateway if needed. The master on the PROFIBUS DP-V1 network can see the status of the Modbus-TCP network in the corresponding status word. The live list feature gives the master on the PROFIBUS DP-V1 network the opportunity to continuously see and monitor the status of each individual transaction on the Modbus-TCP network.

Two additional lists, transaction status and exception codes, retrievable from the module by the master on the PROFIBUS DP-V1 network, provides detailed error information about all transactions.

The amount of data that shall be exchanged, and the use of the control/status word and the live list, is specified separately for each application. This means that even though up to 256 bytes of data can be potentially forwarded to an interface, the amount of data that will actually be exchanged on that network is determined by the Modbus-TCP settings and the application.

The available control/status functionality is described below, as well as the live list and the transaction status and exception code lists. Also note that the terminology and definitions used for different types of data vary greatly between different networking systems.

2.7 I/O Mapped Data

I/O mapped data is cyclic data, exchanged between the networks and/or devices at a high transfer rate. It is associated with data that is continuously sent on the network.

2.8 Parameter Data

Parameter data is usually exchanged acyclically, to set or change parameters in devices before or during normal process. Typical parameter data that can be retrieved from the module from the master of the PROFIBUS DP-V1 network includes the transaction status list and the exception code list.

2.9 Control/Status Word

The Control/Status word is always retrievable using acyclical access. Optionally, the Control/Status word can also be I/O mapped. If so, it is disabled by default. It can be enabled/disabled when configuring the PROFIBUS DP-V1 network via the configuration web interface. See “PROFIBUS DP-V1 (Slave Interface)” on page 36.

For information about how to access the Control/Status word, either I/O mapped or using parameter access, see “Mapping Overview” on page 38.

The Control word is a 16-bit word (uint16) used by the PROFIBUS DP-V1 network to control the Anybus X-gateway and subsequently also the Modbus-TCP network.

Bit	Value	Description
0 (Least significant bit)	0	Puts the X-gateway in idle state
	1	Puts the X-gateway in run state
1	-	A reboot of the X-gateway is triggered by a rising edge, i.e. a transition from 0 to 1
2-7	Set to zero	Unused
8-15	Set to zero	Unused

The Status word is a 16-bit word used by the X-gateway to report its current actual status to the PROFIBUS DP-V1 network.

Bit	Value	Description
0 (Least significant bit)	0	The X-gateway is in idle state
	1	The X-gateway is in run state
1	-	This bit is reflecting the state of bit 1 in the control word Either 0 or 1
2-7	(reserved)	Unused
8-15	(reserved)	Unused

2.10 Live List

The live list features the possibility for the PROFIBUS DP-V1 network to retrieve a list containing the status of every transaction on the Modbus-TCP network.

It is accessible using parameter access, and also I/O mapped by default. The I/O mapped list can be enabled/disabled when configuring the PROFIBUS DP-V1 network settings. See “PROFIBUS DP-V1 (Slave Interface)” on page 36. If the I/O mapped live list is enabled, it will occupy byte 0-7 in either the first slot (control/status word disabled) or the second slot (control/status word enabled and mapped to the first slot).

All transactions and their places in the live list are also visible in the Transaction Monitor on the configuration web pages.

The live list consists of a bit array with 64 elements, where each bit corresponds to a transaction on the Modbus-TCP network as in the table below.

Byte 7		Byte 6-1	Byte 0			
Bit 63	Bit 62-56	Bit 55-8	Bit 7	Bit 6 - 2	Bit 1	Bit 0
Status of transaction no 63	Status of transaction no 62-56	...	Status of transaction no 7	Status of transaction no 6 - 2	Status of transaction no 1	Status of transaction no 0

- **Bit set to 1**

Transaction successful.

- **Bit set to 0**

Transaction not successful.

Note: The reason for the unsuccessful transaction can be found on the corresponding index in the transaction status list.

The order of the transactions in the live list conforms to the order in which they are stored in the Modbus Server list.

Example

Consider the following configuration:

- Server 1 : a total of 2 transactions
- Server 2 : a total of 3 transactions
- Server 3 : a total of 1 transaction

This scenario will produce a live list as follows (assuming that the transactions are successful):

Bit 63	Bit 62 - 6	Bit 5	Bit 4	Bit 3	Bit 2	Bit 1	Bit 0
-	-	Server 3, transaction 1	Server 2, transaction 3	Server 2, transaction 2	Server 2, transaction 1	Server 1, transaction 2	Server 1, transaction 1
0	0	1	1	1	1	1	1

2.11 Transaction Status List

This list holds information about the transactions between the Modbus network and the module, from the perspective of the module.

It is a list available from the module, which is possible to be retrieved acyclically (using parameter access) by the PROFIBUS DP-V1 network. It contains a byte array with 64 elements, where each byte contains a transaction status code as in the table below.

The indexes in the transaction status list correspond completely to the indexes in the transaction live list.

Byte 0	Byte 1	Byte 2-6	Byte 7	Byte 8 - 55	Byte 56-62	Byte 63
Status of transaction no 0	Status of transaction no 1	Status of transaction no 2-6	Status of transaction no 7	...	Status of transaction no 56-62	Status of transaction no 63

Currently available transaction status codes

Transaction Status Code	Description
0	Running ok
1	Gateway idle
2	No link
3	Modbus exception
4	Timeout
5	Gateway disconnect
6	Server disconnect
7	Cannot connect
8	Modbus header error
9	Internal gateway error
10	No valid data
11	Stop sending data to Modbus server
12	Unconfigured transaction

2.12 Exception Code List

If Modbus transactions fail, the slaves can respond with an exception code. These can be found in the exception code list available from the module, possible to be retrieved acyclically (using parameter access) by the PROFIBUS DP-V1 network.

It contains a byte array with 64 elements, where each byte contains an transaction exception code as in the table below.

The indexes in the exception code list correspond completely to the indexes in the transaction live list.

Byte 0	Byte 1	Byte 2-6	Byte 7	Byte 8-55	Byte 56-62	Byte 63
Exception code for transaction no 0	Exception code for transaction no 1	Exception code for transaction no 2 - 6	Exception code for transaction no 7	Exception code for transaction no 8 - 55	Exception code for transaction no 56 - 62	Exception code for transaction no 63

Standard Modbus exception codes

Exception Code	Description
00	No error
01	Illegal function
02	Illegal data address
03	Illegal data value
04	Slave device failure
05	Acknowledge
06	Slave device busy
08	Memory parity error
0A	Gateway path unavailable
0B	Gateway target device failed to respond

Note: The exception codes found in the exception code list are only relevant if the corresponding transaction status codes equals 3: “Modbus exception”. See “Transaction status List” on page 15 for more information.

Note: If the slave responds with an exception code not in the list, refer to the documentation of the slave for details.

3. About the Anybus X-gateway Modbus-TCP

3.1 External View

- A: Power Connector**
 This connector is used to apply power to the X-gateway. It is also possible to connect protective earth (PE) to the power connector. See “Power Connector” on page 22.
- B: SD Card Slot**
 This slot adds the possibility to store and load configurations from an SD card. See “SD Card Functionality” on page 23.
- C: USB Port**
 This port adds the possibility to connect a PC to the X-gateway to perform firmware upgrades. See “USB Connector” on page 21.
- D: Status LEDs**
 See “Status LEDs” on page 20.
- E: DIN-rail Connector**
 The DIN-rail mechanism fastens the X-gateway to a DIN-rail and connects the module to protective earth (PE). See “Mounting the X-gateway” on page 18.
- F: PROFIBUS DP-V1 Connector**
 See “PROFIBUS DP-V1 Connector” on page 21.
- G: Modbus-TCP Connectors**
 2-port switch with daisy chain functionality. See “Modbus-TCP Connectors” on page 21.

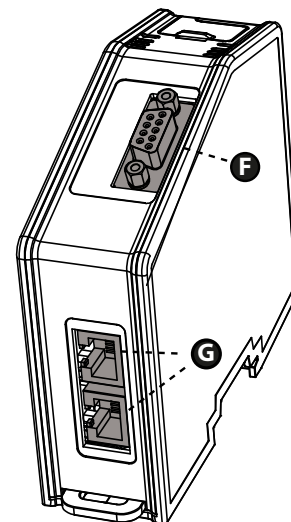
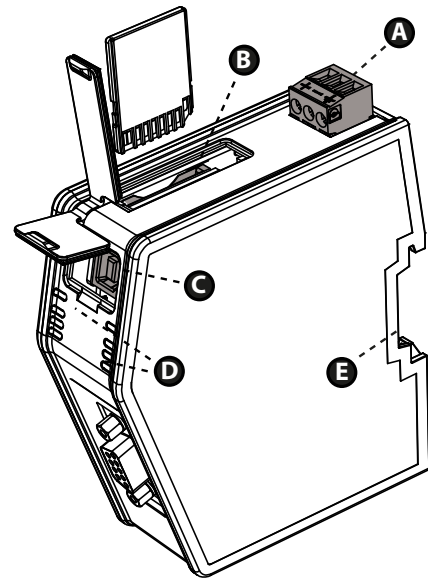

3.2 Mounting the X-gateway

The Anybus X-gateway Modbus-TCP can be physically installed either by mounting it onto a DIN-rail or, if installed in areas exposed to vibration, by mounting it on a wall for more stability.

3.2.1 DIN-rail Mounting

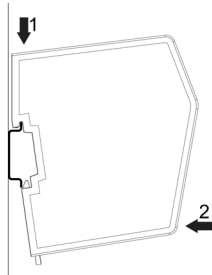

Make sure the DIN-rail fastening mechanism on the back of the module is in a fixed and closed position, i. e. pushed all the way up.

To mount the module, first hook it on to the DIN-rail (1), then push it against the DIN-rail to make it snap on (2).

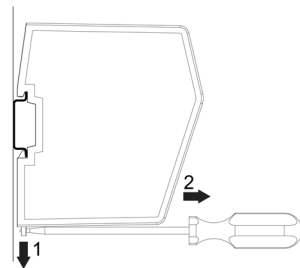

To unmount the module, a screwdriver is needed. Use the screwdriver to push the DIN-rail fastening mechanism on the back of the module down until it locks in a fixed and open position (1). Then unhook the module from the DIN-rail (2).

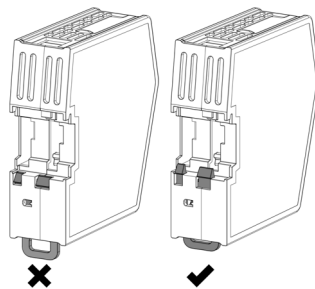

Note: Do not leave the module with the DIN-rail fastening mechanism in a fixed and open position. This may eventually wear the fastening mechanism out so it cannot be used efficiently. Be sure to push the DIN-rail fastening mechanism back into the fixed and closed position after unmounting the module.

3.2.2 Wall Mounting

Use the wall mounting option if there is a need to place the X-gateway in an environment exposed to vibration. This way of mounting the module offers more stability than the traditional DIN-rail mounting.

Note: The X-gateway should be fastened in a standing-up position, to ensure a constant air flow.

Note: When mounting the X-gateway to a wall using the wall mount option, do not forget to connect the module to protective earth (PE) via the power connector. See “Power Connector” on page 22.

Mounting Instructions

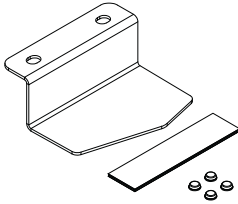
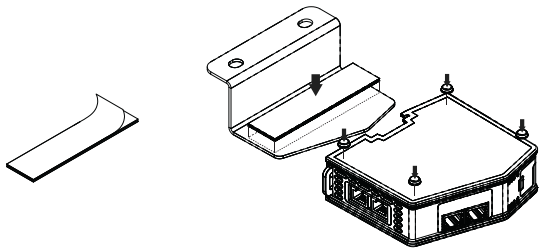
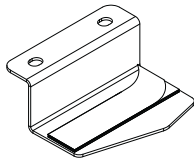
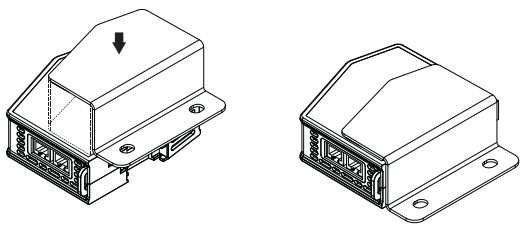
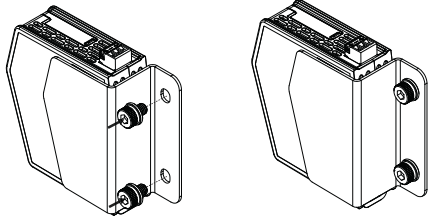
Step	Description	Visual description
1	<p>Open up the package containing the wall mounting accessories.</p> <ul style="list-style-type: none"> - One metal frame - Industrial velcro - Four plastic vibration dampers 	
2	<p>Remove the plastic protection from one side of the velcro.</p> <p>Attach the velcro to the metal frame.</p> <p>Attach the four plastic vibration dampers to the X-gateway, on the side that will face the wall.</p>	
3	<p>Remove the plastic protection from the other side of the velcro.</p>	
4	<p>Turn the X-gateway around, so that the plastic vibration dampers face downwards.</p> <p>Fasten the metal frame to the X-gateway by pressing the frame firmly against the X-gateway, making the two velcro parts attach to each other.</p>	
5	<p>Attach the metal frame and the X-gateway to a wall using screws and washers (not enclosed).</p>	

3.3 Status LEDs

Note: A test sequence is performed on all LEDs during startup.

Note: An identification LED sequence can be performed on LEDs 1, 5 and 6 by clicking the “Wink device” button in the X-gateway Management section in the web configuration interface.

X-gateway and Modbus-TCP Network LEDs

LED no	State	Status
1 - Gateway Status (GW)	Off	Power off
	Alternating red/green	Missing configuration
	Flashing green	Idle
	Green	Running
	Flashing red	Invalid configuration
	Red	Fatal error
5 - SD card (SD)	Green	Accessing SD card
	Flashing red	Failure
6 - Modbus-TCP Status (MTCP)	Off	Power off
	Green	Communicating with Modbus-TCP network
	Flashing red	Transaction error or timeout
	Red	Fatal error
7, 8 - Ethernet Link 1 (LA1), Ethernet Link 2 (LA2)	Off	No link
	Flashing green	Receiving/transmitting Ethernet packets at 10/100 Mbit

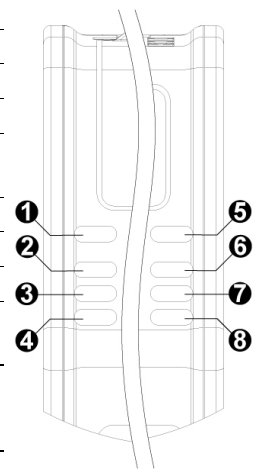

PROFIBUS DP-V1 Network LEDs

LED no	State	Status
2	Not used	-
3 - PROFIBUS DP-V1 Network Status (OP)	Off	Power off, not online
	Green	Online, data exchange
	Flashing green	Online, clear
	Flashing red (1 flash)	Parametrization error
	Flashing red (2 flashes)	Configuration error
4- Module Status (ST)	Off	Power off, not initialized
	Green	Initialized
	Red	Exception error

3.4 PROFIBUS DP-V1 Connector

The connector for the PROFIBUS DP-V1 network is found at the lower front of the module.

Pin no.	Description
1	-
2	-
3	B Line, positive RxD/TxD, RS485 level
4	RTS
5	GND bus
6	+5V bus output
7	-
8	A Line, negative RxD/TxD, RS485 level
9	-
Housing	Shield

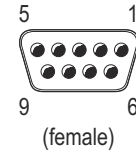

3.5 USB Connector

At the upper front of the module there is a USB connector used for firmware upgrades.

Pin no.	Description
1	+5V Input
2	USBDM (USB communication signals)
3	USBDP (USB communication signals)
4	Signal GND
Housing	Cable Shield

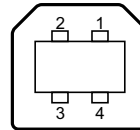

3.6 Modbus-TCP Connectors

The Modbus-TCP connectors are found at the bottom of the module. .

Pin no.	Description
1	TX+
2	TX-
3	RX+
4	Not connected
5	Not connected
6	RX-
7	Not connected
8	Not connected
Housing	Shield

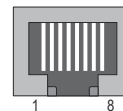

3.7 Power Connector

Pin no.	Description
1	+24V DC
2	GND
3	PE (Protective Earth)

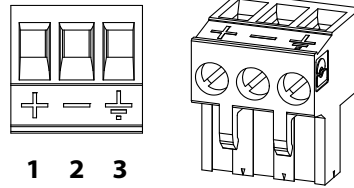

Notes:

- Use 60/75 or 75×C copper (CU) wire only.
- The terminal tightening torque must be between 5... 7 lbs-in (0.5... 0.8 Nm)

See also...

- “Power Supply” on page 41.

4. SD Card Functionality

Using an SD card with the X-gateway adds the following features:

- **Easy backup.**
Every applied change in the configuration will automatically be saved to the X-gateway and the SD card. See “Easy Backup” on page 24.
- **Simple configuration copy.**
Using the SD card, the configuration on one X-gateway can be copied to other X-gateways. See “Simple Configuration Copy” on page 24.
- **Easy replacement.**
If an X-gateway malfunctions during operation, a replacement module can easily be configured by moving the SD card to the new module. See “Easy Replacement” on page 24.

A configuration on the X-gateway is saved automatically to the SD card in any of these two events:

- A configuration is applied in the X-gateway Management section
- A configuration is restored from a backup file

Important

The SD card acts as a master in the X-gateway. When an X-gateway is turned on with an SD card inserted, and that SD card contains a valid configuration file, the configuration on the SD card will always overwrite any configuration on the X-gateway.

4.1 General Advice and Guidelines

Turn the power off before inserting or removing an SD card from the X-gateway.

Do not turn the X-gateway off while the SD LED indicates that the SD card is being accessed. Refer to “Status LEDs” on page 17 for more information.

The X-gateway will not write any data to a write-protected SD card.

4.2 Starting Up

1. Format the SD card for the FAT file system using a PC. The X-gateway cannot use an unformatted SD card.
2. Make sure the SD card is empty and that it is not write-protected.
3. Turn the X-gateway off.
4. Insert the SD card into the SD card slot in the X-gateway.
5. Turn the X-gateway on.
6. Create the configuration. When finished, press the apply button in the X-gateway Management section to reboot using the new configuration. During the reboot, the latest applied configuration will automatically be copied and saved to the SD card.
7. Now, the SD card is synchronized with the X-gateway. Both the SD card and the X-gateway contain the latest applied configuration.

Every time a new configuration is applied in the X-gateway Management section, it is also copied to the SD card to ensure synchronization.

4.3 Easy Backup

Every time a configuration change is applied in the X-gateway Management section using the configuration web pages, the configuration is saved both in the memory of the X-gateway and on the SD card. This is the easiest way of keeping a continuously updated configuration backup.

4.4 Simple Configuration Copy

If a configuration on one X-gateway needs to be copied to one or more other X-gateways, it is easily done using an SD card.

1. Turn the X-gateway running the desired configuration off.
2. Remove the SD card from the X-gateway containing the desired configuration and insert it into another one.
Note 1: The firmware version must be the same or higher in the new X-gateway.
Note 2: The new X-gateway must support the same network type as the first X-gateway.
3. Turn the new X-gateway on. The new X-gateway will automatically start up using the configuration found on the SD card.

Important

If the configuration was protected by authentication information, the same information will be needed to alter the configuration in the new X-gateway.

4.5 Easy Replacement

If an X-gateway malfunctions during operation, the SD card functionality makes it easy to get the application up and running again fast.

1. Turn the malfunctioning X-gateway off.
2. Replace the old X-gateway with a new one.
Note 1: The firmware version must be the same or higher in the new X-gateway.
Note 2: The new X-gateway must support the same network type as the old X-gateway.
3. Remove the SD card containing the configuration file from the old X-gateway and insert it into the new one.
4. Turn the new X-gateway on. If the SD card contains a valid configuration file, the X-gateway will automatically start up using the configuration found on the SD card.

Important

If the configuration was protected by authentication information, the same information will be needed to alter the configuration in the new X-gateway.

Depending on the settings of the master network, the communication link between the X-gateway and the master may no longer be valid. X-gateway settings that were configured from outside the configuration web pages will need to be set again.

4.6 SD Card Synchronization Failure

In the event of applying a configuration or restoring a configuration from a backup file, the SD card synchronization can fail. There are many possible reasons for an SD card write failure:

- The SD card is write-protected.
- The configuration file on the SD card is write-protected.
- The SD card memory is full.
- The SD card file system is corrupt.
- The SD card is damaged.

If the SD card write process fails, the reboot cycle of the X-gateway will halt. The GW LED will indicate “invalid configuration” and the SD LED will indicate “failure”. See “Status LEDs” on page 17.

To eliminate the problem, follow the steps below:

1. Turn the X-gateway off.
2. Remove the SD card. Find the cause of the problem.
3. Insert an SD card.

Note: This SD card must **not** contain a configuration file. If it does, the configuration on the SD card will overwrite the configuration on the X-gateway.

4. Turn the X-gateway on. The X-gateway will run the configuration that was applied or restored when the SD card write process failed.
5. Apply the configuration in the X-gateway Management section to save the configuration to the SD card.
6. Now, the SD card is synchronized with the X-gateway. Both the SD card and the X-gateway contain the latest applied configuration.

5. Modbus-TCP Functions

The Modbus-TCP protocol is an implementation of the standard Modbus protocol, running on top of TCP/IP. The same function codes and addressing model are used.

The Anybus X-gateway Modbus-TCP supports a subset of the functions described in the Modbus-TCP specification.

Modbus-TCP transactions are normally transmitted and received on TCP port no. 502. The X-gateway features the possibility to set TCP ports individually for each Modbus-TCP server.

For detailed information regarding the Modbus-TCP protocol, consult the Open Modbus-TCP Specification.

The Anybus X-gateway Modbus-TCP supports the following Modbus-TCP functions:

Modbus Function	Function Code	No. of Bits/Registers ^a	Direction	Associated with Buffer
Read Coils	1	1-2000	Modbus to Gateway	Input buffer
Read Discrete Inputs	2	1-2000		
Read Holding Registers	3	1-125		
Read Input Registers	4	1-125		
Write Single Coil	5	1	Gateway to Modbus	Output buffer
Write Single Register	6	1		
Write Multiple Coils	15	1-1968		
Write Multiple Registers	16	1-123		
Read/Write Multiple Registers	23	1-125 read 1-121 write	Bidirectional	Input and output buffers

a. Please refer to the Modbus Application Protocol Specification V1.1B for more detailed information.

Modbus-TCP functions are used as important parts of transactions to Modbus-TCP servers. After configuring a server within the Modbus-TCP network, functions can be assigned to it by clicking the ‘Add transaction’ button in the built-in web interface.

See also...

- “Network Configuration” on page 27
- “Modbus Servers” on page 33

6. Network Configuration

6.1 General Information

The Anybus X-gateway features built-in web pages for easy configuration. The web pages are all described in this chapter. To access the web configuration pages, the following system requirements need to be met:

- Internet Explorer 8.0 or 9.0
- Javascript enabled

Note: Altering the configuration while the X-gateway is exchanging data between the two networks may affect performance.

Note: Only one user at a time should be accessing the configuration web pages. If two or more users make simultaneous changes to the configuration, the configuration saved last will overwrite other changes.

There are things to take into consideration when making the configuration.

- Remember to apply the configuration in order for changes to take effect. See “X-gateway Management” on page 37. As soon as you have saved data to the configuration but not yet applied it, you will see the box below at the top of the web pages:

The configuration needs to be applied for changes to take effect. Go to [X-gateway Management](#) page to apply the configuration or cancel changes.

- A maximum of 64 Modbus-TCP servers can be added to the configuration.
- A maximum of 64 transactions can be set up to the servers in the configuration.
- Take care when choosing scan times for the transactions. The minimum allowed scan time (ms) is the total number of transactions multiplied by three and cannot be less than 10 ms.
- Take care not to map too much data.
 - The limits for I/O mapped data (process data) are 244 bytes input data and 244 bytes output data (with a maximum limit of 368 bytes for both input and output data), including optional control/status word and live list.
 - The limits for all data (process data and parameter data) are 256 bytes input data and 256 bytes output data. 512 bytes in total.

6.2 Introduction

To display the configuration and status web pages of the X-gateway, start a web browser and type the IP address of the module in the address field.

The default IP address of the X-gateway is 192.168.0.100. To connect a computer to the X-gateway, make sure that both the computer and the module are using the same subnet mask, e.g. 255.255.255.0. Change the IP address of the computer to 192.168.0.X, where X is any number between 0 and 255 except 100.

If, for example, there is a DHCP server on the network, the IP address might be unknown. In that case, use the Anybus IPconfig tool to find it. The Anybus IPconfig tool can be downloaded from www.anybus.com.

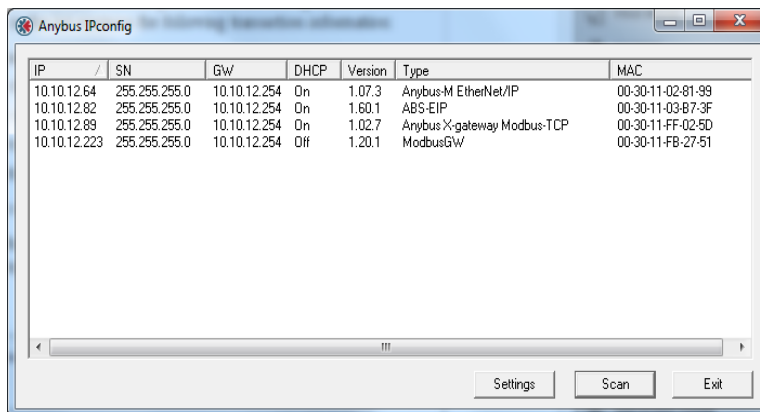

If a list of connected devices does not show automatically, press the scan button. Identify the IP address of the X-gateway by its type 'Anybus X-gateway Modbus-TCP' or by its MAC address. The MAC address of the X-gateway can be found at the bottom of the module.

For additional information about the Anybus IPconfig tool, see "Anybus IPconfig Tool" on page 43.

6.3 Overview

The configuration and status web pages are divided into three sections:

1 Anybus X-gateway Modbus-TCP - PROFIBUS DP-V1

OVERVIEW
[Home](#)
CONFIGURATION
 Authentication
 Modbus Client
 Modbus Servers
 PROFIBUS DP-V1
TOOLS
 X-gateway Management
 Backup & Restore
 Mapping Overview
 Transaction Monitor
 Monitor

Anybus X-gateway configuration and status web pages. Welcome to the configuration interface of the Anybus X-gateway. Use the left side menu to navigate. Changes to the configuration do not take effect until the X-gateway is restarted from the X-gateway Management page. 'Network 1' represents the controlling network, where the X-gateway acts as a server. 'Network 2' represents the controlled network, where the X-gateway acts as a client.

Identification		Ethernet link status	
Product name:	Anybus X-gateway Modbus-TCP	Port 1:	
Firmware version:	1.06	Speed:	-
Serial number:	A01842F5	Duplex:	-
Uptime:	0 days, 0h:0m:14s	Port 2:	
CPU Load:	7% (auto updated every 5s)	Speed:	100 Mbps
MAC ID (Modbus-TCP):	00:30:11:07:9B:F8	Duplex:	Full Duplex

Operation Mode		Ethernet link statistics	
PROFIBUS DP-V1 (Network 1):	No I/O data exchanged	In pkts:	55 Errors: 0
Modbus-TCP (Network 2):	Idle	Out pkts:	37 Errors: 0

© 2011 HMS Industrial Networks - All rights reserved Support Connecting Devices™

1. Headline Section

Shows the Anybus logo and the name of the product.

2. Navigation Section

All functionality is easily accessed from the different links. Every link and its corresponding functionality will be explained later in this chapter.

3. Content Section

Clicking a link will display its contents in the content section. A short text describing the functionality of the current page will be available at the top of the section.

6.3.1 Home

The introductory window of the configuration and status web pages presents important error tracking information, as well as general information and statistics.

OVERVIEW	Anybus X-gateway configuration and status web pages. Welcome to the configuration interface of the Anybus X-gateway. Use the left side menu to navigate. Changes to the configuration do not take effect until the X-gateway is restarted from the X-gateway Management page. 'Network 1' represents the controlling network, where the X-gateway acts as a server. 'Network 2' represents the controlled network, where the X-gateway acts as a client.	
Home		
CONFIGURATION		
Authentication		
Modbus Client		
Modbus Servers		
PROFIBUS DP-V1		
TOOLS		
X-gateway Management		
Backup & Restore		
Mapping Overview		
Transaction Monitor		
	Identification	Ethernet link status
	Product name: Anybus X-gateway Modbus-TCP	Port 1: Speed: -
	Firmware version: 1.06	Duplex: -
	Serial number: A01842F5	Port 2: Speed: 100 Mbps
	Uptime: 0 days, 0h:0m:14s	Duplex: Full Duplex
	CPU Load: 7% (auto updated every 5s)	
	MAC ID (Modbus-TCP): 00:30:11:07:9B:F8	
	Operation Mode	Ethernet link statistics
	PROFIBUS DP-V1 (Network 1): No I/O data exchanged	In pkts: 55 Errors: 0
	Modbus-TCP (Network 2): Idle	Out pkts: 37 Errors: 0

Operation Mode

The table below shows the correlation between the operation modes of the PROFIBUS DP-V1 network and the Modbus-TCP network.

		PROFIBUS DP-V1 (Network 1)	
		I/O data exchanged	No I/O data exchanged
Modbus-TCP (Network 2)	Run	Data is exchanged between the two networks.	The PROFIBUS DP-V1 network exchanges no data. Data to the Modbus-TCP network is in clear, freeze, stop or safe value state.
	Idle	The Modbus-TCP network exchanges no data. Data to the PROFIBUS DP-V1 network is in clear or freeze state.	No data is exchanged. Both networks, independently, are in clear, freeze, stop or safe value state.

In case of an error on the PROFIBUS DP-V1 network, the following additional fieldbus status may appear:

PROFIBUS DP-V1 (Network 1)	Description
Shutdown	Unexpected error (the X-gateway needs a restart)

6.4 Configuration

Please note that changes made to the configuration will not be used by the X-gateway until they have been applied and saved. See “X-gateway Management” on page 37.

6.4.1 Authentication

Authentication can be enabled or disabled. If enabled, it is possible to set a username and password to protect the configuration in the module.

The screenshot shows a web interface for configuring administrator authentication. The title bar reads "Administrator authentication". Underneath, there is a section labeled "Authentication" with a note: "If authentication is enabled username and password can be changed below. Current username and password is never shown when entering this page." To the right of this note is a dropdown menu currently set to "Disabled". Below the note are three input fields: "New username", "New password", and "Confirm new password". At the bottom of the form are two buttons: "Cancel" and "Save settings".

When choosing a username and a password, use only the valid characters shown below.

Item	Valid characters
Username	A-Z, a-z, 0-9, _ (underscore). Max length: 13 characters.
Password	A-Z, a-z, 0-9, _ (underscore). Max length: 12 characters.

Important Notice

Note that it is very important to save the authentication information. There is no way to retrieve a lost username or password. If the authentication information is lost, the only way to restore the X-gateway is to download new firmware via the USB interface. This will erase any configuration currently on the module.

6.4.2 Modbus Client

Configuration of the client side of the Modbus-TCP network. On this side, the X-gateway will act as a Modbus-TCP client. To the right, in the “Actual” column, the currently used values can be seen..

Anybus X-gateway Modbus-TCP - PROFIBUS DP-V1

Modbus client configuration (Network 2). Configure the Modbus-TCP (Network 2) settings.

IP Configuration		Actual
IP address	192.168.0.100	10.10.13.104
Subnet mask	255.255.255.0	255.255.255.0
Router IP address	127.0.0.1	10.10.13.1
DHCP	Enabled	
Anybus IPconfig (HICP)	Enabled	

Other settings

Start-up operation mode: Running

Action in case of irrecoverable error: Shutdown

Buttons: Cancel, Save settings

© 2011 HMS Industrial Networks - All rights reserved Support Connecting Devices™

Available IP Configuration Settings

Item	Description
IP address	If not set by DHCP (or HICP), set these values manually.
Subnet mask	
Router IP address	
DHCP	Enabled by default. When enabled, the X-gateway can obtain the TCP/IP settings dynamically from the DHCP server of the Modbus-TCP network.
Anybus IPconfig (HICP)	Enabled by default. When enabled, the TCP/IP settings for the Modbus-TCP network can be configured temporarily with the Anybus IPconfig tool. See “Anybus IPconfig Tool” on page 43.

Start-up Operation Mode

Value	Description
Running	The Modbus-TCP client starts to exchange data with the servers as soon as possible after start-up.
Idle	The Modbus-TCP client does not exchange any data with the servers and waits for instructions via the control word.

Action in Case of Irrecoverable Error

If the X-gateway encounters an irrecoverable error, there are two possible options.

Value	Description
Shutdown	The X-gateway will shut down. All LEDs will display red.
Restart	The X-gateway will restart.

When finished configuring the Modbus-TCP client, click ‘Save settings’. Note that the changes will not take effect until they are applied in the X-gateway management section. See “X-gateway Management” on page 37.

6.4.3 Modbus Servers

The configuration of the servers on the Modbus-TCP network is made here. The X-gateway can handle up to 64 different servers, and a maximum of 64 transactions distributed among those servers.

It is possible to exchange up to 244 bytes of I/O mapped data (process data) in either direction (but a total of 368 bytes in both input and output data), including control/status word and live list.

The total amount of data that can be exchanged (process data and parameter data) is 512 bytes (256 bytes in either direction).

The global configuration limits box keeps track of the number of added transactions, the current amount of I/O mapped input and output data and the total I/O mapped data. It also keeps track of the total amount of data in the configuration, including both I/O mapped data and not I/O mapped data.

Global configuration limits.
 Transactions: 1/64 | I/O mapped input data: 40/244 bytes | I/O mapped output data: 64/244 bytes | I/O mapped input bits: 0/1024 | I/O mapped output bits: 0/1024 | Input data: 32/256 bytes | Output data: 64/256 bytes | Total I/O mapped data: 104/368 bytes |

Add Server

Click 'Add server' to add a server to the configuration. Click 'Edit' to see and edit the settings:

Available editable settings:

Setting	Description
Name	While not required, renaming the server makes the configuration easier to comprehend. Note that it is only possible to use uppercase and lowercase characters, numerals and underscore (_). Default alias is 'New_Server', followed by an incremental suffix. Max length: 32 characters.
Server address	The IP address of the server.
Protocol	TCP.
Port	Default Modbus-TCP port is 502. If the server requires it, it is possible to change. Value range: 0 - 65535.

When the server is configured, click 'Ok'.

Note: When the server and its settings are configured, transactions must be added to the server. See "Add Transactions" on page 34. At any time, it is possible to have only one server without specified transactions.

Add Transactions

Transactions represent the data that is read from/written to the servers of the Modbus-TCP network.

The global configuration limits box keeps track of the number of added transactions, the current minimum allowed scan time, and the current amount of I/O mapped data as well as total amount of data (both I/O mapped and not I/O mapped data).

Global configuration limits.
 Transactions: 1/64 | Minimum allowed scan time: 10 | I/O mapped input data: 40/244 bytes | I/O mapped output data: 64/244 bytes | I/O mapped input bits: 0/1024 | I/O mapped output bits: 0/1024 | Input data: 32/256 bytes | Output data: 64/256 bytes | Total I/O mapped data: 104/368 bytes

To add transactions, find the server in the server list and click 'Transactions'. This presents a list of all transactions configured for that server. Click 'Add transaction' to add a new default transaction to the list and click 'edit'.

OVERVIEW

Home

CONFIGURATION

Authentication

Modbus Client

Modbus Servers

PROFIBUS DP-V1

TOOLS

X-gateway Management

Backup & Restore

Mapping Overview

Transaction Monitor

Transactions configuration. Add, edit or delete transactions used for a connections on this page. On each connection several transactions towards a Modbus server can be set up. Press 'Add transaction' button to add a new transaction, then edit it to set transaction properties. The global limit is 64 transaction and it is not possible to map more process data than the gateway can handle.

Global configuration limits.
 Transactions: 1/64 | Minimum allowed scan time: 10 | I/O mapped input data: 40/244 bytes | I/O mapped output data: 64/244 bytes | I/O mapped input bits: 0/1024 | I/O mapped output bits: 0/1024 | Input data: 32/256 bytes | Output data: 64/256 bytes | Total I/O mapped data: 104/368 bytes

Name			IP address			Port	Protocol			
New_Server1			0.0.0.0			502	TCP			
#	Function	Encoding	Scan time	Timeout	UID	Address / Bit	Data Type	Elements	Registers	Action on no Network1 I/O
New_Trans1	23	BBEWLE	250	5000	255	1/1	uint16/uint16	16/32	16/32	Freeze

Hovering mouse over an element where the cursor shows a question mark displays help.

Add/edit transaction

General transaction settings			
Function code	23-Read/Write Multiple registers	Name	New_Trans1
Data encoding	Byte Big Endian, Word Little Endian	Timeout (ms)	5000
Trigger	Cyclic	Scan time (ms)	250
I/O mapped	Yes	Unit Id	255
Read settings			
Starting register	1	Data type	uint16
Elements	16	Registers	16
Write settings			
Starting register	1	Data type	uint16
Elements	32	Registers	32
When PROFIBUS DP-V1 (Network1) is not exchanging I/O data	Freeze data to Modbus server	Safe Element Value	Not applicable
Startup-mode	Wait for data		

Available settings are explained in detail on the next page.

Available settings

Setting	Description
Function code	The function code defines the purpose of the transaction. Choose from the different available Modbus functions, see “Modbus-TCP Functions” on page 26.
Data encoding	Decides in what order the different bytes of the received/transmitted data shall be sent on the network.
Trigger	Only applicable for write transactions. Cyclic. On data change.
I/O mapped	Decides whether to map the data to the memory area that is cyclically exchanged between the PROFIBUS network and the Modbus-TCP network (I/O mapped data).
Name	While not required, renaming the transaction makes the configuration easier to comprehend. Note that it is only possible to use uppercase and lowercase characters, numerals and underscore (_). Default alias is 'New_Trans', followed by an incremental suffix. Max length: 32 characters.
Timeout (ms)	The time span within which the server must return a response to the transaction. If no response is received within the timeout period, the connection to the server will be closed. If the connection to the server is closed, all transactions to that server will be affected. Value range: 10 - 65535 (ms).
Scan time (ms)	The scan time defines how often the transaction shall be resent, e.g. the time cycle of a repeating transaction. Minimum scan time (ms) is calculated by multiplying the total number of transactions by three. The minimum scan time will increase by adding more transactions. Value range: 10 - 10000 (ms).
Unit ID	Only applicable for Modbus RTU servers. If the Modbus-TCP server functions as a router to Modbus RTU servers, it is possible to send transactions to a single Modbus RTU server using the unit ID. Value range: 0 - 247; 255. If not communicating with a Modbus RTU server, use the value 255 (default).
Starting register/bit	The starting Modbus server register or bit to write to/read from. Value range: 1 - 65536.
Elements	The number of elements to write/read. Value range: See “Modbus-TCP Functions” on page 26.
When PROFIBUS DP-V1 (Network1) is not exchanging I/O data	Note: Only available for I/O mapped write transactions. Clear data to Modbus server: only zeros will be transmitted. Freeze data to Modbus server: the data that was stored last will be repeated. Write safe value: choose a specific value to transmit for every element (See safe element value below). Stop: no data will be transmitted to the Modbus server.
Data type	Write/read data either as two byte integers (uint16) or four byte integers (uint32).
Registers	The resulting amount of registers to write/read. The calculation is based on the number of elements to read/write and the chosen data type.
Safe Element Value	Note: Only available for write transactions. A numeric value to send for every element if network 1 (PROFIBUS DP-V1) is not exchanging I/O data.
Startup-mode	Wait for data (default): all data for the transaction must have been sent from the PROFIBUS DP-V1 network and received by the X-gateway before the transaction is carried out. Directly: the data is sent as soon as possible after start-up.

When finished editing the transaction, click ‘Ok’. All data resulting from configured transactions will be mapped to the internal memory of the X-gateway. Read transactions will be mapped to the input area, and write transactions will be mapped to the output area. See “Mapping Overview” on page 38 for more information.

Note: The X-gateway needs to be restarted before any changes will take effect. See “X-gateway Management” on page 37.

6.4.4 PROFIBUS DP-V1 (Slave Interface)

Configuration of the PROFIBUS DP-V1 slave interface of the X-gateway.

OVERVIEW	PROFIBUS DP-V1 configuration (Network 1). Configure the Network 1 side of the X-gateway. Enabling or disabling the mapping of the control/status word or the live list affects the process data size.		
Home			
CONFIGURATION			
Authentication			
Modbus Client	Global configuration limits.		
Modbus Servers	Transactions: 1/64 I/O mapped input data: 40/244 bytes I/O mapped output data: 64/244 bytes I/O mapped input bits: 0/1024 I/O mapped output bits: 0/1024 Input data: 32/256 bytes Output data: 64/256 bytes Total I/O mapped data: 104/368 bytes		
PROFIBUS DP-V1			
TOOLS			
X-gateway Management			
Backup & Restore			
Mapping Overview			
Transaction Monitor			

Setting	Configured	Actual
Node address	126	126
When Modbus-TCP (Network 2) error	Freeze data to master	
I/O mapped control/status word	Disabled	
I/O mapped live list	Enabled	
Reserved bytes, read bit transactions	0	
Reserved bytes, write bit transactions	0	

Cancel Save settings

What is shown is the currently stored configuration, provided that all changes are saved and applied to the X-gateway.

The column 'Actual' presents the settings that are currently used. If enabled (see table below), the node address can be changed from the PROFIBUS DP-V1 network during runtime and will then override the chosen value in the configuration web pages.

Note that no changes will take effect until the configuration has been applied. See "X-gateway Management" on page 37.

Available settings for the PROFIBUS DP-V1 network

Setting	Description
Node Address	The X-gateway slave address on the PROFIBUS DP-V1 network. Default value: 126 (if set to this value, the node address of the X-gateway can be changed from the PROFIBUS network during runtime). Value range: 0 - 126.
When Modbus (Network 2) error	The "Freeze data to master" option instructs the X-gateway to keep sending the latest received data from the Modbus-TCP network to the PROFIBUS DP-V1 master. The "Clear data to master" option instructs the X-gateway to clear the input data area and send only zeros to the PROFIBUS DP-V1 master.
I/O mapped control/status word	If enabled, the control/status word is mapped to the output/input area respectively. See "I/O Mapped Data" on page 13.
I/O mapped live list	If enabled, the live list is mapped to the input area. See "Live List" on page 14.
Reserved bytes, read bit transactions	0: dynamic. 2 - 128: The number of bytes that shall be reserved for read bit transactions. Note: the chosen value must be even.
Reserved bytes, write bit transactions	0: dynamic. 2 - 128: The number of bytes that shall be reserved for read bit transactions. Note: the chosen value must be even.

6.5 Tools

6.5.1 X-gateway Management

Apply changes

Permanently store changes made to the configuration and reboot, using the new configuration.

No changes made in the configuration will be permanently stored or used by the X-gateway until they are applied by clicking 'Apply'.

Before storing and rebooting, the X-gateway will validate the not yet stored configuration. If errors are found, the X-gateway will produce an information message with instructions to correct the errors. The X-gateway will not store an invalid configuration.

Reboot and undo changes

The X-gateway will be restarted. All changes made since the last configuration was loaded will be undone.

Undo changes

Undo all changes made since the last configuration was loaded.

Factory reset

Reset the X-gateway to completely remove the configuration currently stored in the module.

Wink device

Clicking the "Wink" button will start a 15 second LED sequence on the X-gateway. For identification purposes.

6.5.2 Backup and Restore

Backup the configuration that is currently used to file, or restore a previously saved configuration from file.

It is not possible to backup or restore the configuration until all changes are either applied or undone. See "X-gateway Management" on page 37.

Two things can happen when loading an old configuration:

- **Configuration valid:**
The X-gateway will reboot and automatically use the previously stored configuration.
- **Configuration not valid:**
The X-gateway will produce an error message. The chosen configuration will not be accepted or loaded into memory.

Important Notice

Before loading a previously stored configuration, locate any authentication information associated with it. If a valid configuration is loaded that is protected by a password, the configuration can not be modified until the authentication information has been provided.

6.5.3 Mapping Overview

This page provides a description of all data resulting from the transactions of the currently applied configuration. It is divided into two parts. The first part describes the X-gateway interface to the PROFIBUS DP-V1 network, and the second part all applied transactions on the Modbus-TCP network.

If needed, it is possible to print the configuration to paper. Click the printer symbol to the right on the mapping overview page to access a printer friendly version of the mapping overview.

PROFIBUS DP-V1

- **Configuration data**

An overview of all I/O mapped data.

- **Slot details, cyclic I/O**

A description of the slots resulting from the I/O mapped transactions of the currently applied configuration. If I/O mapped control/status word and live list are enabled, they also show here in separate slots. The slots each contain a maximum of 64 words of data. If the configuration contains more than 64 words in either input or output data, the data will be split up in two or more slots. When configuring the PROFIBUS DP-V1 PLC, take care to retain the slot order as seen in the data section in the overview.

The I/O data will always be divided into slots according to the following priority order:

- Control/status word (optional)
- Live list (optional)
- Input data (bit transactions will always be mapped first)
- Output data (bit transactions will always be mapped first)

All data from the PROFIBUS DP-V1 network to the Modbus-TCP network (write data) will be mapped as output data. In the same way all data from the Modbus-TCP network to the PROFIBUS DP-V1 network (read data) will be mapped as input data.

- **Parameters, DP-V1 acyclic I/O**

A detailed list of all data, including both the I/O mapped and the not I/O mapped data, available from the X-gateway to the PROFIBUS DP-V1 network. This list also includes the transaction status and exception code lists, available for error identification.

- “Exception Code List” on page 16
- “Transaction status List” on page 15

Modbus-TCP network

A detailed list of all Modbus servers and transactions in the configuration.

6.5.4 Mapping Overview Example

Note that changes to the configuration that are not applied and saved will not show in the overview.

Data Mapping Overview. Shows how configured transactions, control word, status word and live list are mapped from Network 2 to Network 1 in the X-gateway and vice versa.

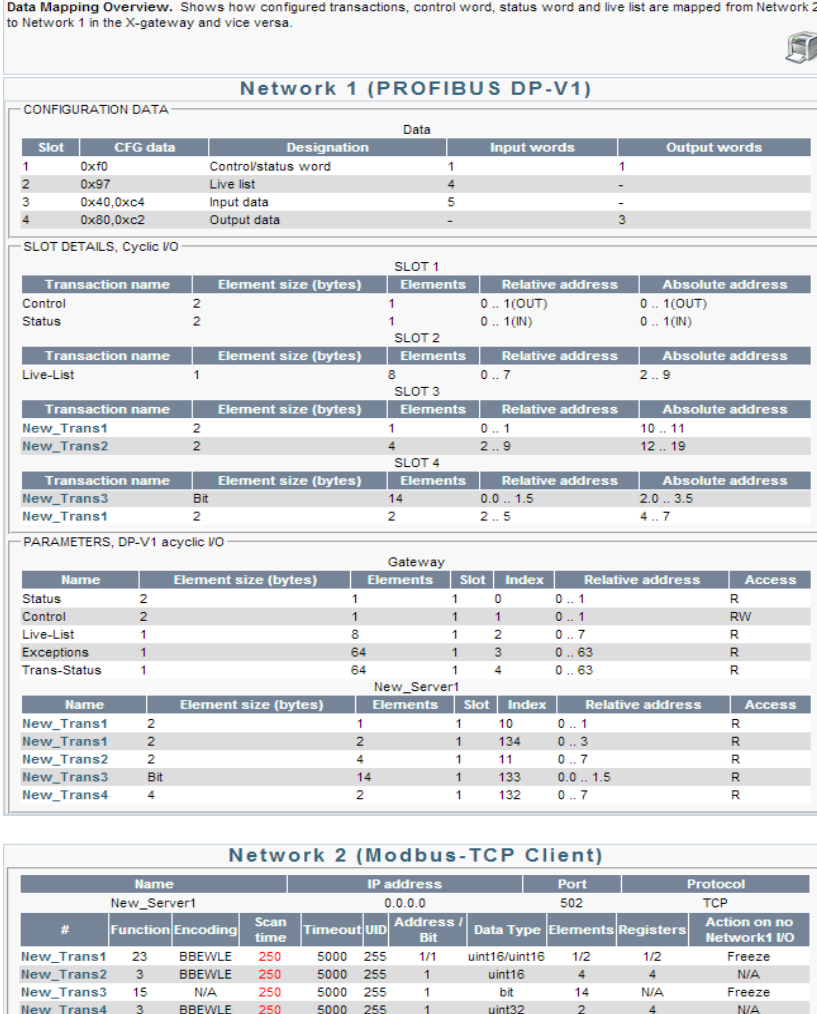

The screenshot displays the configuration for two networks: Network 1 (PROFIBUS DP-V1) and Network 2 (Modbus-TCP Client).

Network 1 (PROFIBUS DP-V1)

CONFIGURATION DATA

Slot	CFG data	Designation	Input words	Output words
1	0xf0	Control/status word	1	1
2	0x97	Live list	4	-
3	0x40,0xc4	Input data	5	-
4	0x80,0xc2	Output data	-	3

SLOT DETAILS, Cyclic I/O

SLOT 1

Transaction name	Element size (bytes)	Elements	Relative address	Absolute address
Control	2	1	0 .. 1 (OUT)	0 .. 1 (OUT)
Status	2	1	0 .. 1 (IN)	0 .. 1 (IN)

SLOT 2

Transaction name	Element size (bytes)	Elements	Relative address	Absolute address
Live-List	1	8	0 .. 7	2 .. 9

SLOT 3

Transaction name	Element size (bytes)	Elements	Relative address	Absolute address
New_Trans1	2	1	0 .. 1	10 .. 11
New_Trans2	2	4	2 .. 9	12 .. 19

SLOT 4

Transaction name	Element size (bytes)	Elements	Relative address	Absolute address
New_Trans3	Bit	14	0.0 .. 1.5	2.0 .. 3.5
New_Trans1	2	2	2 .. 5	4 .. 7

PARAMETERS, DP-V1 acyclic I/O

Gateway

Name	Element size (bytes)	Elements	Slot	Index	Relative address	Access
Status	2	1	1	0	0 .. 1	R
Control	2	1	1	1	0 .. 1	RW
Live-List	1	8	1	2	0 .. 7	R
Exceptions	1	64	1	3	0 .. 63	R
Trans-Status	1	64	1	4	0 .. 63	R

New_Server1

Name	Element size (bytes)	Elements	Slot	Index	Relative address	Access
New_Trans1	2	1	1	10	0 .. 1	R
New_Trans1	2	2	1	134	0 .. 3	R
New_Trans2	2	4	1	11	0 .. 7	R
New_Trans3	Bit	14	1	133	0.0 .. 1.5	R
New_Trans4	4	2	1	132	0 .. 7	R

Network 2 (Modbus-TCP Client)

Name		IP address		Port		Protocol				
New_Server1		0.0.0.0		502		TCP				
#	Function	Encoding	Scan time	Timeout	UID	Address / Bit	Data Type	Elements	Registers	Action on no Network1 I/O
New_Trans1	23	BBEWLE	250	5000	255	1/1	uint16/uint16	1/2	1/2	Freeze
New_Trans2	3	BBEWLE	250	5000	255	1	uint16	4	4	N/A
New_Trans3	15	N/A	250	5000	255	1	bit	14	N/A	Freeze
New_Trans4	3	BBEWLE	250	5000	255	1	uint32	2	4	N/A

This example includes four transactions. The control/status word and the live list are both I/O mapped. The resulting slots for the I/O mapped data can be found in the configuration data box and a detailed view is available in the slot details box:

- New_Trans1: an I/O mapped read/write transaction, reading two bytes and writing two bytes.
- New_Trans2: an I/O mapped read transaction, reading a total of eight bytes.
- New_Trans3: an I/O mapped write transaction, writing 14 bits. Notice how it is placed before New_Trans1 in the SLOT4 list.
- New_Trans4: a not I/O mapped read transaction, reading a total of eight bytes. Notice how this transaction is only available from the parameter data box.

In the parameter data box, all configured data is presented. Details for acyclically accessing control/status word, live list, exceptions list and transaction status list, as well as both I/O mapped and not I/O mapped data, are available here.

6.5.5 Transaction Monitor

The transaction monitor interface presents a detailed list of all transactions currently operating on the Modbus-TCP network. The data is automatically updated, and it is possible to choose to view the data either in decimal or in hexadecimal values. The time that has passed since the last update is visible at the top of the transaction list. Every post in the list contains the following transaction information:

- Server name and transaction name
- The type of Modbus function chosen for the transaction
- The size of the data read from or written to the Modbus-TCP network
- The actual data read from or written to the Modbus-TCP network
- The bit position of the transaction in the live list (also presented as byte.bit).

If there is a transaction error, an error code will appear instead of the data. See “Exception Code List” on page 16, for the standard Modbus exception codes.

A red frame around the list indicates that the web browser has lost connection to the web server of the X-gateway. If this happens, try reloading the page by clicking on “Transaction Monitor” in the menu to the left.

Data automatically updated from the X-gateway. Seconds since last update: 1	
Show hexadecimal Show decimal	
New_Server1 >> New_Trans1 >> 23-Read/Write Multiple registers	Live-List bit 0 (0.0)
Reading 1 uint16 elements >> 2 bytes 00 00	
Writing 1 uint16 elements >> 2 bytes 00 00	
New_Server1 >> New_Trans2 >> 23-Read/Write Multiple registers	Live-List bit 1 (0.1)
Reading 1 uint16 elements >> 0 bytes Transaction error (Modbus Exception), no data to display. Exception code 2 (Illegal Data Address).	
Writing 1 uint16 elements >> 0 bytes Transaction error (Modbus Exception), no data to display. Exception code 2 (Illegal Data Address).	
New_Server1 >> New_Trans3 >> 16-Write Multiple Registers	Live-List bit 2 (0.2)
Writing 1 uint16 elements >> 0 bytes Transaction error (No valid data), no data to display.	

Note: Viewing the transaction monitor may affect performance.

A. Technical Specification

A.1 Protective Earth (PE) Requirements

In order to achieve proper EMC behavior, the product must be connected to protective earth (PE) via the DIN-rail connector. If the DIN-rail cannot be used, PE must be connected to the power connector.

HMS Industrial Networks does not guarantee proper EMC behavior unless these PE requirements are fulfilled.

Note: Make sure the DIN-rail is properly connected to PE.

A.2 Power Supply

Supply Voltage

The X-gateway requires a regulated 24 V (20.4 V to 28.8 V) DC power source.

Power Consumption

The typical power consumption is 150 mA at 24 V.

A.3 Environmental Specification

A.3.1 Temperature

Operating

-25° to +70° Celsius

Non-operating

-40° to +85° Celsius

A.3.2 Relative Humidity

The product is designed for a relative humidity of 5% to 95% noncondensing.

A.4 EMC (CE) Compliance

EMC compliance testing has been conducted according to the Electromagnetic Compatibility Directive 2004/108/EC. For more information please consult the EMC compliance document, see product/support pages for Anybus X-gateway Modbus-TCP at www.anybus.com.

B. Anybus IPconfig Tool

The X-gateway supports the HICP protocol used by the Anybus IPconfig tool and all Anybus products.

It is possible to see and alter the TCP/IP settings for the X-gateway manually by using the IPconfig Tool.

At start-up, the IPconfig tool presents a list of all Anybus products that are connected to the network. The list can be refreshed by clicking 'scan'. The X-gateway is identified in the list by its type 'Anybus X-gateway Modbus-TCP' or by its MAC address (found at the bottom of the module).

Right-clicking a row in the list makes it possible to either visit the web interface of the product, or bring up the configuration window. Double-clicking a row also brings up the configuration window.

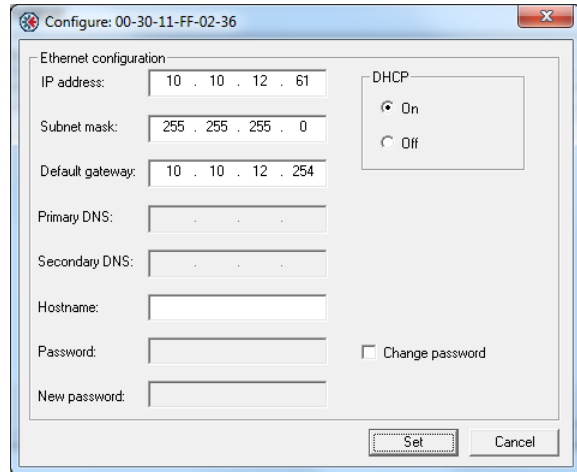

In the configuration window the TCP/IP settings can be set or changed. Save the new settings by clicking 'set', or exit without saving by clicking 'cancel'.

Note: the IPconfig tool provides the opportunity to set a username and a password. The X-gateway, however, will not accept any configuration changes where the password has been altered.

Note: if the X-gateway configuration is protected by a password, it is not possible to alter the TCP/IP settings.

C. Copyright Notices

This product includes software developed by Carnegie Mellon, the Massachusetts Institute of Technology, the University of California, and RSA Data Security:

Copyright 1986 by Carnegie Mellon.

Copyright 1983,1984,1985 by the Massachusetts Institute of Technology

Copyright (c) 1988 Stephen Deering.

Copyright (c) 1982, 1985, 1986, 1992, 1993

The Regents of the University of California. All rights reserved.

This code is derived from software contributed to Berkeley by Stephen Deering of Stanford University.

Redistribution and use in source and binary forms, with or without modification, are permitted provided that the following conditions are met:

- Redistributions of source code must retain the above copyright notice, this list of conditions and the following disclaimer.
- Redistributions in binary form must reproduce the above copyright notice, this list of conditions and the following disclaimer in the documentation and/or other materials provided with the distribution.
- Neither the name of the University nor the names of its contributors may be used to endorse or promote products derived from this software without specific prior written permission.

THIS SOFTWARE IS PROVIDED BY THE REGENTS AND CONTRIBUTORS "AS IS" AND ANY EXPRESS OR IMPLIED WARRANTIES, INCLUDING, BUT NOT LIMITED TO, THE IMPLIED WARRANTIES OF MERCHANTABILITY AND FITNESS FOR A PARTICULAR PURPOSE ARE DISCLAIMED. IN NO EVENT SHALL THE REGENTS OR CONTRIBUTORS BE LIABLE FOR ANY DIRECT, INDIRECT, INCIDENTAL, SPECIAL, EXEMPLARY, OR CONSEQUENTIAL DAMAGES (INCLUDING, BUT NOT LIMITED TO, PROCUREMENT OF SUBSTITUTE GOODS OR SERVICES; LOSS OF USE, DATA, OR PROFITS; OR BUSINESS INTERRUPTION) HOWEVER CAUSED AND ON ANY THEORY OF LIABILITY, WHETHER IN CONTRACT, STRICT LIABILITY, OR TORT (INCLUDING NEGLIGENCE OR OTHERWISE) ARISING IN ANY WAY OUT OF THE USE OF THIS SOFTWARE, EVEN IF ADVISED OF THE POSSIBILITY OF SUCH DAMAGE.

Copyright (C) 1990-2, RSA Data Security, Inc. All rights reserved.

License to copy and use this software is granted provided that it is identified as the "RSA Data Security, Inc. MD4 Message-Digest Algorithm" in all material mentioning or referencing this software or this function.

License is also granted to make and use derivative works provided that such works are identified as "derived from the RSA Data Security, Inc. MD4 Message-Digest Algorithm" in all material mentioning or referencing the derived work.

RSA Data Security, Inc. makes no representations concerning either the merchantability of this software or the suitability of this software for any particular purpose. It is provided "as is" without express or implied warranty of any kind.

These notices must be retained in any copies of any part of this documentation and/or software.

Copyright (C) 1991-2, RSA Data Security, Inc. Created 1991. All rights reserved.

License to copy and use this software is granted provided that it is identified as the "RSA Data Security, Inc. MD5 Message-Digest Algorithm" in all material mentioning or referencing this software or this function.

License is also granted to make and use derivative works provided that such works are identified as "derived from the RSA Data Security, Inc. MD5 Message-Digest Algorithm" in all material mentioning or referencing the derived work.

RSA Data Security, Inc. makes no representations concerning either the merchantability of this software or the suitability of this software for any particular purpose. It is provided "as is" without express or implied warranty of any kind.

These notices must be retained in any copies of any part of this documentation and/or software.