

# SMA 50 Ohm End Launch Jack Receptacle - Round Contact

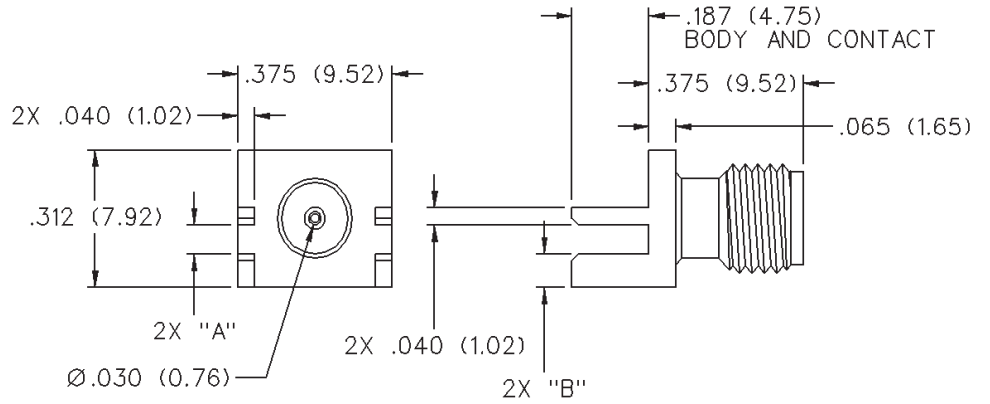

INCHES (MILLIMETERS)  
CUSTOMER DRAWINGS AVAILABLE UPON REQUEST



VSWR & FREQ. RANGE	BOARD THICKNESS	GOLD PLATED	NICKEL PLATED	"A"	"B"
VSWR: N/A 0-18 GHz	.062 (1.57)	142-0701-801	142-0701-806	.068 (1.73)	.073 (1.85)

# SMA - 50 Ohm Connectors

Specifications



INCHES (MILLIMETERS)  
CUSTOMER DRAWINGS AVAILABLE UPON REQUEST

## ELECTRICAL RATINGS

**Impedance:** 50 ohms

**Frequency Range:**

Dummy loads .....	0-2 GHz
Flexible cable connectors .....	0-12.4 GHz
Uncabled receptacles, RA semi-rigid and adapters .....	0-18.0 GHz
Straight semi-rigid cable connectors and field replaceable connectors .....	0-26.5 GHz

**VSWR:** (f = GHz)

	Straight Cabled Connectors	Right Angle Cabled Connectors
RG-178 cable .....	1.20 + .025f	1.20 + .03f
RG-316, LMR-100 cable .....	1.15 + .02f	1.15 + .03f
RG-58, LMR-195 cable .....	1.15 + .01f	1.15 + .02f
RG-142 cable .....	1.15 + .01f	1.15 + .02f
LMR-200, LMR-240 cable .....	1.10 + .03f	1.10 + .06f
.086 semi-rigid .....	1.07 + .008f	1.18 + .015f
.141 semi-rigid (w/contact) .....	1.05 + .008f	1.15 + .015f
.141 semi-rigid (w/o contact) .....	1.035 + .005f	
Jack-bulkhead jack adapter and plug-plug adapter .....	1.05 + .01f	
Jack-jack adapter and plug-jack adapter .....	1.05 + .005f	
Uncabled receptacles, dummy loads .....	N/A	
Field replaceable (see page 59) .....	N/A	

**Working Voltage:** (Vrms maximum)

Connectors for Cable Type	Sea Level	70K Feet
RG-178 .....	170	45
RG-316; LMR-100, 195, 200 .....	250	65
RG-58, RG-142, LMR-240, .086 semi-rigid, uncabled receptacles, .141 semi-rigid w/o contact ...	335	85
.141 semi-rigid with contact and adapters .....	500	125
Dummy loads .....	N/A	

**Dielectric Withstanding Voltage:** (VRMS minimum at sea level)

Connectors for RG-178 .....	500
Connectors for RG-316; LMR-100, 195, 200 .....	750
Connectors for RG-58, RG-142, LMR-240, .086 semi-rigid, field replaceable, uncabled receptacles .....	1000
Connectors for .141 semi-rigid with contact and adapters .....	1500
Connectors for .141 semi-rigid w/o contact, dummy loads .....	N/A

**Corona Level:** (Volts minimum at 70,000 feet)

Connectors for RG-178 .....	125
Connectors for RG-316; LMR-100, 195, 200 .....	190
Connectors for RG-58, RG-142, LMR-240, .086 semi-rigid, uncabled receptacles, .141 semi-rigid w/o contact .....	250
Connectors for .141 semi-rigid with contact and adapters .....	375
Dummy loads .....	N/A

**Corona Level:** (Volts minimum at 70,000 feet)

Connectors for RG-178 .....	125
Connectors for RG-316; LMR-100, 195, 200 .....	190
Connectors for RG-58, RG-142, LMR-240, .086 semi-rigid, uncabled receptacles, .141 semi-rigid w/o contact .....	250
Connectors for .141 semi-rigid with contact and adapters .....	375
Dummy loads .....	N/A

**Corona Level:** (Volts minimum at 70,000 feet)

**Corona Level:** (Volts minimum at 70,000 feet)

**Corona Level:** (Volts minimum at 70,000 feet)

**Corona Level:** (Volts minimum at 70,000 feet)

**Corona Level:** (Volts minimum at 70,000 feet)

**Corona Level:** (Volts minimum at 70,000 feet)

**Corona Level:** (Volts minimum at 70,000 feet)

**Corona Level:** (Volts minimum at 70,000 feet)

**Corona Level:** (Volts minimum at 70,000 feet)

**Corona Level:** (Volts minimum at 70,000 feet)

**Corona Level:** (Volts minimum at 70,000 feet)

**Corona Level:** (Volts minimum at 70,000 feet)

**Corona Level:** (Volts minimum at 70,000 feet)

**Corona Level:** (Volts minimum at 70,000 feet)

**Corona Level:** (Volts minimum at 70,000 feet)

**Corona Level:** (Volts minimum at 70,000 feet)

**Corona Level:** (Volts minimum at 70,000 feet)

**Corona Level:** (Volts minimum at 70,000 feet)

**Corona Level:** (Volts minimum at 70,000 feet)

**Corona Level:** (Volts minimum at 70,000 feet)

**Corona Level:** (Volts minimum at 70,000 feet)

**Corona Level:** (Volts minimum at 70,000 feet)

**Corona Level:** (Volts minimum at 70,000 feet)

**Corona Level:** (Volts minimum at 70,000 feet)

**Corona Level:** (Volts minimum at 70,000 feet)

**Corona Level:** (Volts minimum at 70,000 feet)

**Corona Level:** (Volts minimum at 70,000 feet)

**Insertion Loss:** (dB maximum)

Straight flexible cable connectors and adapters .....	0.06	$\sqrt{f}$ (GHz), tested at 6 GHz
Right angle flexible cable connectors .....	0.15	$\sqrt{f}$ (GHz), tested at 6 GHz
Straight semi-rigid cable connectors with contact .....	0.03	$\sqrt{f}$ (GHz), tested at 10 GHz
Right angle semi-rigid cable connectors .....	0.05	$\sqrt{f}$ (GHz), tested at 10 GHz
Straight semi-rigid cable connectors w/o contact .....	0.03	$\sqrt{f}$ (GHz), tested at 16 GHz
Straight low loss flexible cable connectors .....	0.06	$\sqrt{f}$ (GHz), tested at 1 GHz
Right Angle low loss flexible cable connectors .....	0.15	$\sqrt{f}$ (GHz), tested at 1 GHz
Uncabled receptacles, field replaceable, dummy loads .....		N/A

**Insulation Resistance:** 5000 megohms minimum

**Contact Resistance:** (milliohms maximum) Initial After Environmental

Center contact (straight cabled connectors and uncabled receptacles) .....	3.0*	4.0*
Center contact (right angle cabled connectors and adapters) .....	4.0	6.0
Field replaceable connectors .....	6.0	8.0
Outer contact (all connectors) .....	2.0	N/A
Braid to body (gold plated connectors) .....	0.5	N/A
Braid to body (nickel plated connectors) .....	5.0	N/A

\*N/A where the cable center conductor is used as a contact

**RF Leakage:** (dB minimum, tested at 2.5 GHz)

Flexible cable connectors, adapters and .141 semi-rigid connectors w/o contact .....	-60 dB
Field replaceable w/o EMI gasket .....	-70 dB
.086 semi-rigid connectors and .141 semi-rigid connectors with contact, and field replaceable with EMI Gasket .....	-90 dB
Two-way adapters .....	-90 dB
Uncabled receptacles, dummy loads .....	N/A

**RF High Potential Withstanding Voltage:** (Vrms minimum, tested at 4 and 7 MHz)

Connectors for RG-178 .....	335
Connectors for RG-316; LMR-100, 195, 200 .....	500
Connectors for RG-58, RG-142, LMR-240, .086 semi-rigid, .141 semi-rigid cable w/o contact, uncabled receptacles .....	670
Connectors for .141 semi-rigid with contact and adapters .....	1000

**Power Rating (Dummy Load):** 0.5 watt @ +25°C, derated to 0.25 watt @ +125°C

## MECHANICAL RATINGS

**Engagement Design:** MIL-C-39012, Series SMA

**Engagement/Disengagement Force:** 2 inch-pounds maximum

**Mating Torque:** 7 to 10 inch-pounds

**Bulkhead Mounting Nut Torque:** 15 inch-pounds

**Coupling Proof Torque:** 15 inch-pounds minimum

**Coupling Nut Retention:** 60 pounds minimum

**Contact Retention:**

6 lbs. minimum axial force (captivated contacts)

4 inch-ounce minimum torque (uncabled receptacles)

**Cable Retention:**

	Axial Force*(lbs)	Torque (in-oz)
Connectors for RG-178 .....	10	N/A
Connectors for RG-316, LMR-100 .....	20	N/A
Connectors for LMR-195, 200 .....	30	N/A
Connectors for RG-58, LMR-240 .....	40	N/A
Connectors for RG-142 .....	45	N/A
Connectors for .086 semi-rigid .....	30	16
Connectors for .141 semi-rigid .....	60	55

\*Or cable breaking strength whichever is less.

**Durability:** 500 cycles minimum

100 cycles minimum for .141 semi-rigid connectors w/o contact

**ENVIRONMENTAL RATINGS** (Meets or exceeds the applicable paragraph of MIL-C-39012)

**Temperature Range:** -65°C to +165°C

**Thermal Shock:** MIL-STD-202, Method 107, Condition B

**Corrosion:** MIL-STD-202, Method 101, Condition B

**Shock:** MIL-STD-202, Method 213, Condition I

**Vibration:** MIL-STD-202, Method 204, Condition D

**Moisture Resistance:** MIL-STD-202, Method 106

†Avoid user injury due to misapplication. See safety advisory definitions inside front cover.

Cinch Connectivity Solutions

299 Johnson Avenue SW, Waseca, MN 56093 USA • 800.247.8256 • +1 507 833 8822 • cinchconnectivity.com

# SMA - 50 Ohm Connectors

Specifications



INCHES (MILLIMETERS)  
CUSTOMER DRAWINGS AVAILABLE UPON REQUEST

## MATERIAL SPECIFICATIONS

**Bodies:** Brass per QQ-B-626, gold plated\* per MIL-G-45204 .00001" min. or nickel plated per QQ-N-290

**Contacts:** Male - brass per QQ-B-626, gold plated per MIL-G-45204 .00003" min.

Female - beryllium copper per QQ-C-530, gold plated per MIL-G-45204 .00003" min.

**Nut Retention Spring:** Beryllium copper per QQ-C-533. Unplated

**Insulators:** PTFE fluorocarbon per ASTM D 1710 and ASTM D 1457 or Tefzel per ASTM D 3159 or PFA 340 per ASTM

**Expansion Caps:** Brass per QQ-B-613, gold plated per MIL-G-45204 .00001" min. or nickel plated per QQ-N-290

**Crimp Sleeves:** Copper per WW-T-799 or brass per QQ-B-613, gold plated per MIL-G-45204 .00001" min. or nickel plated per QQ-N-290

**Mounting Hardware:** Brass per QQ-B-626 or QQ-B-613, gold plated per MIL-G-45204 .00001" min. or nickel plated per QQ-N-290

**Seal Rings:** Silicone rubber per ZZ-R-765

**EMI Gaskets:** Conductive silicone rubber per MIL-G-83528, Type M

\* All gold plated parts include a .00005" min. nickel underplate barrier layer.

### Mating Engagement for SMA Series per MIL-C-39012

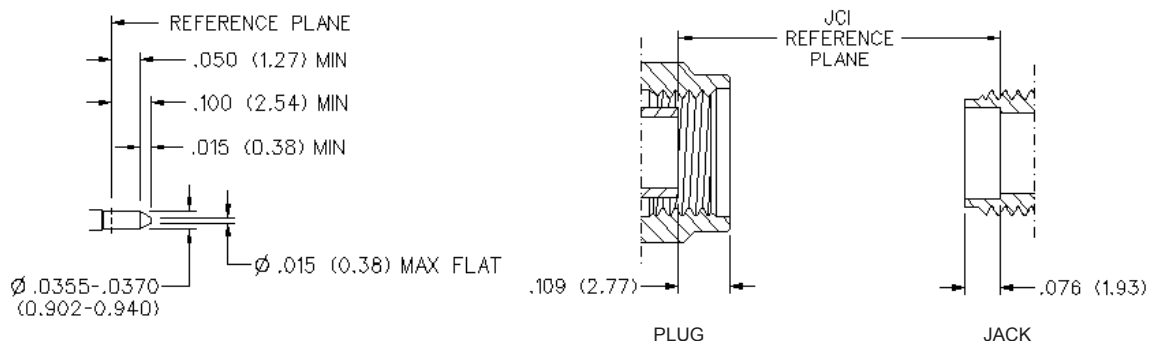
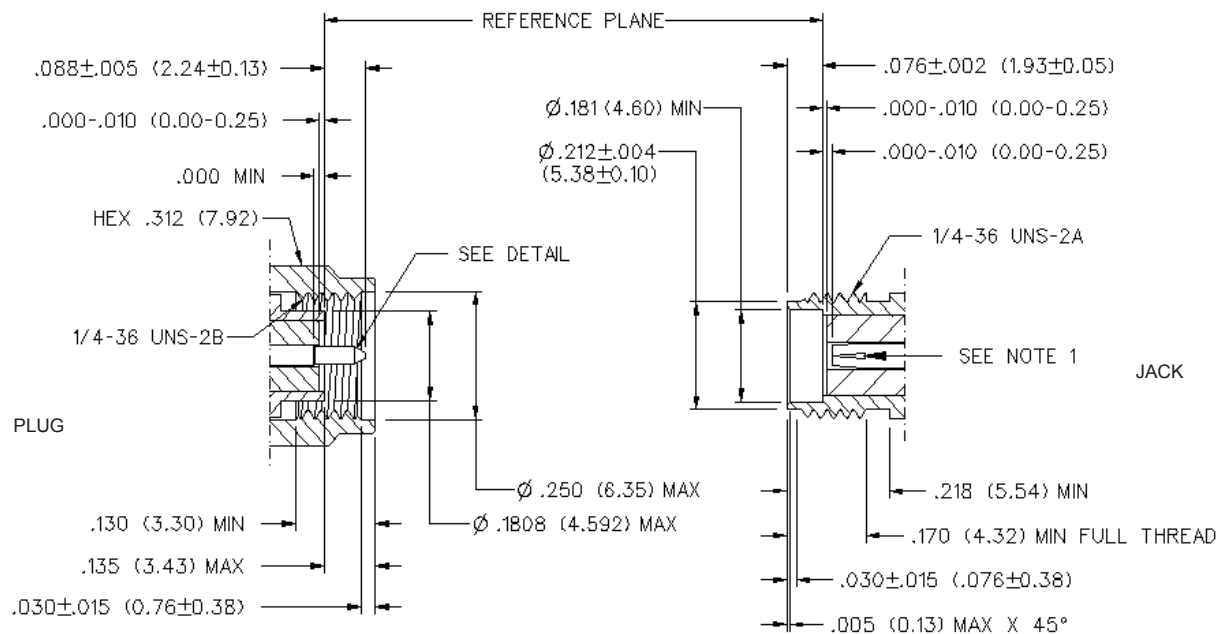

#### NOTES

1. ID OF CONTACT TO MEET VSWR, CONTACT RESISTANCE AND INSERTION WITHDRAWAL FORCES WHEN MATED WITH DIA .0355-.0370 MALE PIN.

Cinch Connectivity Solutions

299 Johnson Avenue SW, Waseca, MN 56093 USA • 800.247.8256 • +1 507 833 8822 • cinchconnectivity.com

# SMA - 50 Ohm Connectors

End Launch Connectors - A Johnson Components™ Original



INCHES (MILLIMETERS)  
CUSTOMER DRAWINGS AVAILABLE UPON REQUEST

The **End Launch** connector is attached to the circuit board by inserting the board edge between the legs and soldering the legs and center conductor to pads on the board. For optimum high frequency performance, the connector to circuit board transition must be adjusted for low VSWR. To compensate for the transition from coax to microstrip, trace widths "A" and "B" must be adjusted based on circuit board thickness. When properly adjusted, this technique yields a low VSWR over a wide bandwidth.

The tabulated dimensions "A", "B", "C", "D", and "E" were determined experimentally to achieve low VSWR (typically less than 1.5 up to 18 GHz). The circuit board used for these tests was double-sided FR 4 with 1 oz. copper on both sides. The copper was left on the bottom of the board to create a ground plane for the 50 Ohm microstrip structure. While not all inclusive, these dimensions are given as reference information for selected **SMA End Launch** connectors. Further adjustments may be necessary depending upon the application. All dimensions are in inches.

Tabulated Dimensions "A", "B", "C" and "D" are symmetrical about the center line



Part Number	Base Width	Board Thick	"A"	"B"	"C"	"D"	"E"
142-0701-801/806	.375	.062	.103	.090	.250	.440	.200
142-0701-851/861	.375	.062	.103	.090	.250	.440	.200
142-0711-871/876	.375	.062	.103	.090	.250	.440	.200
142-0711-821/826	.250	.062	.103	.070	.170	.380	.165
142-0711-871/876	.375	.047	.083	.075	.250	.440	.200
142-0711-881/886	.375	.047	.083	.075	.250	.440	.200
142-0701-881/886	.375	.031	.050	.045	.250	.440	.200

## Surface Mount Versions Available!

### SMA End Launch Specifications

#### ELECTRICAL RATINGS

**Impedance:** 50 Ohms  
**Frequency Range:** 0-18 GHz  
**VSWR:** Dependent upon application  
**Working Voltage (VRMS max.):** 335 @ Sea Level, 85 @ 70K Feet  
**Dielectric Withstanding Voltage (VRMS min. at sea level):** 1000  
**Corona Level (Volts min. at 70,000 feet):** 250  
**Insulation Resistance:** 5000 megohms min  
**Contact Resistance (milliohms max.):** 3.0 Initial, 4.0 after environmental  
**RF High Potential Withstanding Voltage (VRMS min. tested at 4 and 7 MHz):** 670

#### MECHANICAL RATINGS

**Engagement Design:** MIL-C-39012, Series SMA  
**Engagement/Disengagement Force:** 2 inch-pounds max.  
**Mating Torque:** 7 to 10 inch-pounds  
**Coupling Proof Torque:** 15 inch-pounds min.  
**Coupling Nut Retention:** 60 pounds min.  
**Contact Retention Force:** 6 lbs min. axial force, 4 inch-ounce min. torque  
**Durability:** 500 cycles min.

#### ENVIRONMENTAL RATINGS:

(Meets or exceeds the applicable paragraph of MIL-C-39012)  
**Temperature Range:** -65° to + 165° C  
**Thermal Shock:** MIL-STD-202, Method 107, Condition B  
**Corrosion:** MIL-STD-202, Method 101, Condition B  
**Shock:** MIL-STD-303, Method 213, Condition I  
**Vibration:** MIL-STD-202, Method 204, Condition D  
**Moisture Resistance:** MIL-STD-202, Method 106

#### MATERIAL SPECIFICATIONS

**Bodies:** Brass per QQ-B-626, gold plated\* per MIL-G-45204 .00001" min. or nickel plated per QQ-N-290  
**Contacts:** Male - brass per QQ-B-626, gold plated per MIL-G-45204 .00003" min.  
 Female - beryllium copper per QQ-C-530, gold plated per MIL-G-45204 .00003" min.  
**Nut Retention Spring:** Beryllium copper per QQ-C-533. Unplated  
**Insulators:** PTFE fluorocarbon per ASTM D 1710 and ASTM D 1457  
**Mounting Hardware:** Brass per QQ-B-626 or QQ-B-613, gold plated per MIL-G-45204 .00001" min. or nickel plated per QQ-N-290

\*All gold plated parts include a .00005" min. nickel underplate barrier layer.