

INTERNATIONAL HEADQUARTERS
20 Willow Springs Circle, York, Pa. 17402, (717) 767-6511
Web site- <http://www.redlion-controls.com>

RED LION CONTROLS (UK)
Tapton Park, Chesterfield, Derbyshire S41 0TZ
ENGLAND +44 1246 222122 FAX: +44 1246 221222

MODEL PRA1 - PULSE RATE TO ANALOG CONVERTER

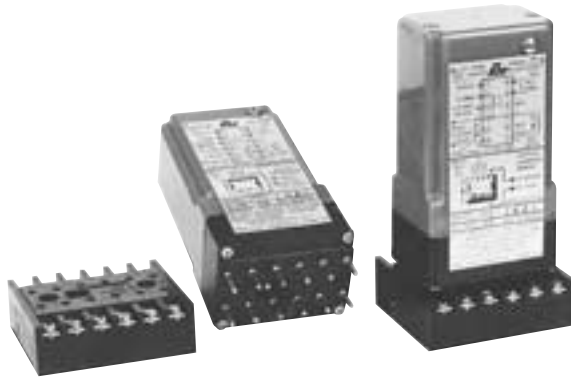

- DELIVERS ANALOG OUTPUT PROPORTIONAL TO INPUT PULSE-RATE (Frequency)
- ACCEPTS VARIABLE PULSE-RATE INPUTS FROM A WIDE VARIETY OF SENSORS
- DUAL SIGNAL OUTPUT, 0 to 10 VDC PLUS SELECTABLE SIGNAL CURRENT OUTPUT OF 0 to 1 mA OR 4 to 20 mA
- AVAILABLE IN 5 FREQUENCY RANGE RATINGS FROM 30 Hz to 10 KHz
- ACCURACY (Linearity) 0.25%

DESCRIPTION

The Model PRA1 is a convenient plug-in module that provides voltage and current analog output signals proportional to the pulse-rate (*frequency*) of the input signal. In typical applications the PRA1 input is supplied by a machine mounted sensor that generates a signal which has a frequency proportional to machine or process speed. The PRA1 converts the frequency content of this signal to analog form for operating chart recorders, supplying speed control signals, or driving other controls and indicators that require analog input.

The PRA1 develops an internal "constant-area" pulse from the trailing (*negative going*) edge of each input pulse or wave form cycle. These "Constant-area" pulses are fixed in voltage amplitude and time duration. The PRA1 then takes the average of a train of these pulses to generate an output voltage level proportional to the frequency. Another circuit within the PRA1 monitors the voltage output and produces a current output signal that will deliver either 0 to 1 or 4 to 20 mA, as determined by a set-up switch.

These units are available in five overlapping adjustable range ratings, each rating providing a calibration adjustment to deliver maximum output over an input frequency range of approximately 3.3:1. Since the PRA1 develops an output by averaging pulses, an inherent response time is involved (*See response table, next page*). The minimum response time is fixed for each range rating. It is longest for the lowest range rating and decreases as the frequency range rating increases. Response time must be considered, when using the PRA1 to provide closed-loop speed feedback signals, to avoid stability problems. For speed feedback applications it is usually advisable to select a high frequency range unit coupled with an appropriate sensor arrangement that delivers a high pulse rate.

The internal filtering supplied for averaging purposes is kept to a minimum

in order to provide the fastest practical response time for each range rating.

Additional external capacitance can be added to provide more filtering if required.

The plug-in module mates with a heavy duty, CSA approved base mounting socket with pressure clamp screw terminals that accept stripped wires without lugs. Closed back construction allows mounting directly on metal panel without an insulation barrier.

Note: Not recommended for closed loop speed control. Refer to the RLC Catalog for the MDC - Motor Drive Controller.

SPECIFICATIONS

1. **PRIMARY SUPPLY VOLTAGE:** Available for 115 or 230 VAC $\pm 10\%$, 50/60 Hz; 2.5 VA (*See Ordering Information*).
2. **SENSOR OUTPUT POWER:** +12 VDC $\pm 5\%$ regulated, 60 mA max.
3. **SIGNAL INPUT CHARACTERISTICS:** See "PRA1 & PRS1 Input Circuits, Sensor Connections & Configuration Switch Set-ups" section.
4. **FREQUENCY RANGES AVAILABLE:** (*See Ordering Information*)
5. **SIGNAL VOLTAGE OUTPUT:** 0 to 10 VDC @ 10 mA max.
6. **SIGNAL CURRENT OUTPUT (Selectable):**
0 to 1 mA into load resistance range 0 to 4 K Ω .
4 to 20 mA into load resistance range 0 to 250 Ω .
7. **LINEARITY:** $\pm 0.25\%$ of full range setting.
8. **VOLTAGE/CURRENT OUTPUT TRACKING:** Current Signals follow voltage signals within $\pm 3\%$ of full range setting.
9. **RESPONSE TIME:** See table on next page.
10. **OPERATING TEMPERATURE RANGE:** 0 to 60°C.
11. **WEIGHT:** PRA1 - 8 oz (226.8 g); Mating 12-Pin Socket - 2 oz (56.7 g).

DIMENSIONS "In inches (mm)"

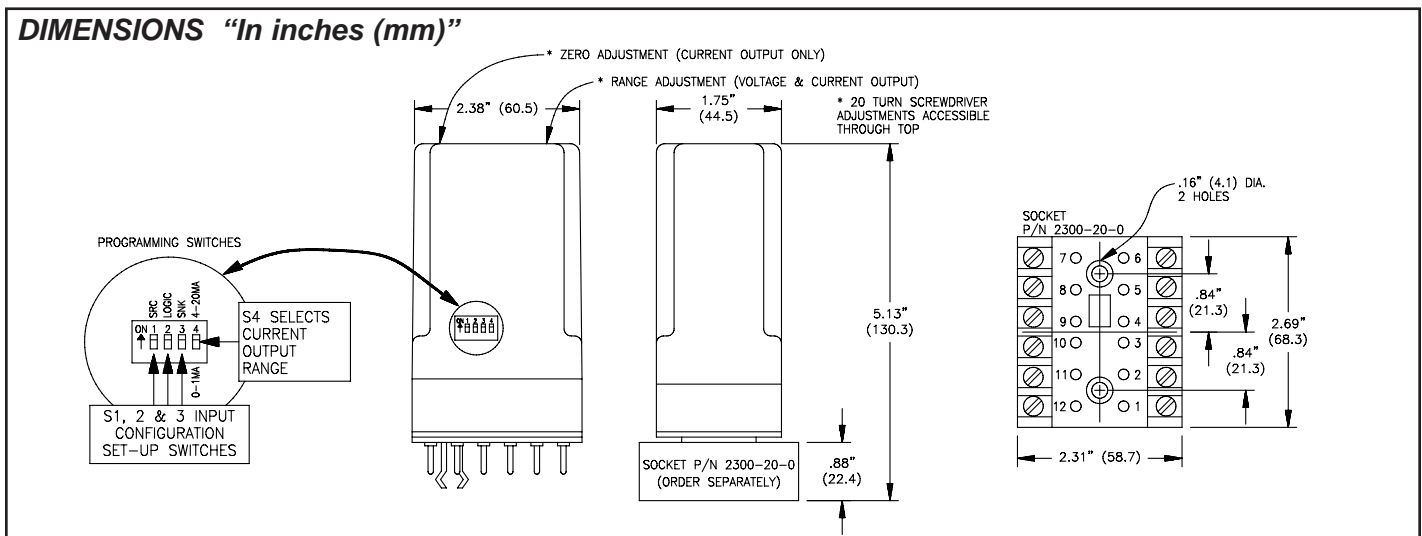

PRA1 APPLICATION CONSIDERATIONS

CONNECTIONS & SET-UP ADJUSTMENTS

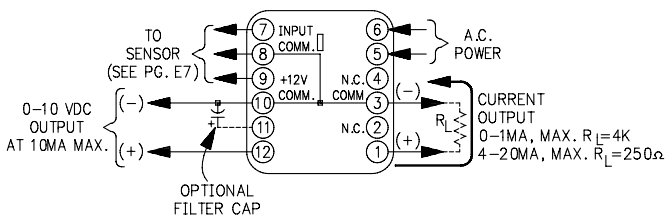

VOLTAGE OUTPUT ADJUSTMENT:

Only the RANGE ADJUSTMENT is effective when voltage output is used. (Zero Adjustment affects only current output.)

PROCEDURE

Apply the maximum input frequency and set the *RANGE ADJUSTMENT to obtain the desired output voltage.

CURRENT OUTPUT ADJUSTMENTS:

When current output is used, the ZERO ADJUSTMENT must be set before RANGE ADJUSTMENT setting is attempted.

PROCEDURE

- Select current range (0-1, or 4-20 mA) with switch S4.
- Connect a milliammeter in series with the current loop circuit from Term 1 to Term 3. CAUTION: DO **NOT** exceed maximum load resistance specified for the current range.
- Zero Adjustment:
 - 0-1 mA Range - With input signal removed (zero frequency) turn ZERO ADJUST CW until positive current flow is indicated. Then, turn back CCW until the current flow just reaches zero. Stop turning the adjustment at that point.
 - 4-20 mA Range - Set ZERO ADJUST until current is 4 mA.
- *Range Adjustment: Apply maximum frequency input signal and set RANGE ADJUSTMENT to get desired output.

* RANGE ADJUSTMENT - Turning CW decreases output at a given frequency (increases range) and turning CCW increases output (decreases range). To calibrate the RANGE ADJUST, apply a known oscillator frequency to the input, or operate the sensor-equipped machine at a known speed and frequency. Then, set the output as required.

ADJUSTABLE RANGE RATINGS & OVER RANGE OPERATION

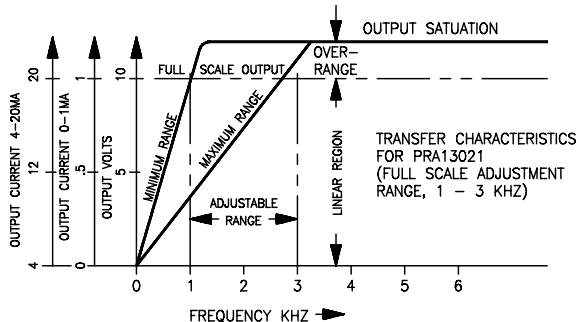

The Transfer Curve (at left) shows the frequency-input/voltage-output relationship for the PRA13021 for both Min. Range (0-1 KHz) and Max. Range (0-3 KHz) adjustment. These curves are typical and apply to all PRA1 ranges.

As shown by these curves, the PRA1 RANGE ADJUSTMENT allows the unit to be calibrated to deliver full scale output for any input frequency from the min. to max. range ratings. As long as the input frequency is equal-to or less-than the full-scale range setting, the PRA1 is operating in its linear region and the output voltage or current will be proportional to input frequency. If the input frequency exceeds the full-scale range setting (over range), the output will flatten out and saturate at some level above 10 V at all higher frequencies.

CAUTION: Maximum input frequency for PRA1 modules is 10 KHz. At input frequencies in excess of 10 KHz, the frequency roll-off characteristics of the input circuit will cause signal dropout and result in discontinuous operation.

OUTPUT RESPONSE & RIPPLE CHARACTERISTICS

PRA1 Modules are supplied with a minimum amount of output ripple filtering in order to avoid compromising response-time. The data presented below, permits a reasonable estimate of the amount of ripple and the response-time that will be experienced in a particular application. As shown by the curves below, the amount of output ripple depends on the range setting and the input frequency.

Ripple voltage can be reduced by adding external filter capacitance, but ripple-reduction is a trade-off against increased response times. This must be

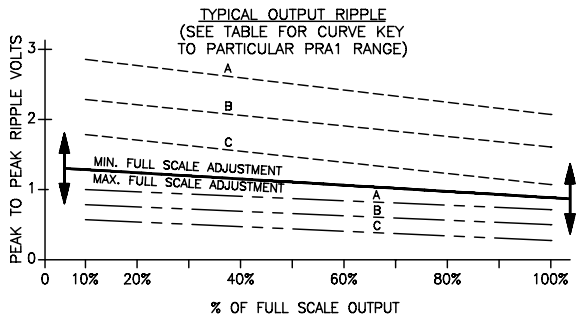

kept in mind, especially if the PRA1 is to be used to supply feedback control signals.

The values of capacitance given in the table are for reference only and do not imply a limit to the amount of capacitance that can be added. For example, an external filter capacitance may be 10 times the reference values shown for a very high degree of ripple reduction, provided that the resulting long response time is acceptable.

Note: If large capacitor values are required to achieve a high degree of ripple reduction, tantalum capacitors rated at 35 V or more are recommended. (Proper polarity must be observed. See Connection Drawing above.)

PART NUMBER	FULL SCALE RANGE ADJUSTMENT		RESPONSE TIME [1]	RIPPLE CURVE [2]	EXT CAP (REF) [3]
	MIN	MAX			
PRA1101-1 OR -2	30 Hz	100 Hz	250 msec	A	2.2 mfd
PRA1301-1 OR -2	100 Hz	300 Hz	75 msec	A	0.56 mfd
PRA1102-1 OR -2	0.3 KHz	1 KHz	25 msec	A	0.22 mfd
PRA1302-1 OR -2	1 KHz	3 KHz	10 msec	B	0.1 mfd
PRA1103-1 OR -2	3 KHz	10 KHz	8 msec	C	0.047 mfd

- [1] RESPONSE TIME - Time required for the output to reach 90% of final value when the frequency is instantly changed from 0 to full-scale range frequency.
- [2] See "Typical Output Ripple" Curves (at left).
- [3] External Capacitance can be added between terminals 10 and 11 to decrease ripple. Reference values shown in MFD, will reduce ripple approximately 50% and will roughly double response times.

ORDERING INFORMATION

MODEL NO.	DESCRIPTION	A.C. POWER	PART NUMBERS FOR AVAILABLE SUPPLY VOLTAGES				
			30-100 Hz	100-300 Hz	300-1 K Hz	1 K-3 K Hz	3 K-10 KHz
PRA1	Pulse Rate to Analog Converter	115VAC 230VAC	PRA11011	PRA13011	PRA11021	PRA13021	PRA11031
—	Socket, 12-Pin		PRA11012	PRA13012	PRA11022	PRA13022	PRA11032
			2300200				

PRA1 & PRS1 INPUT CIRCUITS, SENSOR CONNECTIONS & CONFIGURATION SWITCH SET-UP

The Model PRS1 Speed Switch and the Model PRA1 Pulse-Rate to Analog Converter both use the circuit shown on the right. The circuit uses a comparator amplifier connected as a Schmidt trigger circuit to convert the input wave form into the pulse form required for proper circuit operation. Three set-up switches are used to configure the input circuit to accept signals from a wide variety of sources, as follows:

- S1 - ON:** Connects a 1 K pull-down resistor for sensors with sourcing output. (Maximum sensor output current is 12 mA @ 12 V output.)
- S2 - ON:** Sets bias of input to trigger at $V_{IL} = 2.5$ V, $V_{IH} = 3.0$ V; for logic level signals.
OFF: Sets the bias of input to trigger at $V_{IL} = 0.25$ V, $V_{IH} = 0.75$ V; for increased sensitivity when used with magnetic pickups.
- S3 - ON:** Connects a 3.9 K pull-up resistor for sensors with current sinking output. (Maximum sensor current is 3 mA.)

OTHER CHARACTERISTICS & SPECIFICATIONS

- Maximum Operating Frequency:** 10 KHz with maximum pulse width ON and OFF times of 50 μ sec.
- Maximum Input Voltage:** Pin 7 (Input) may be driven from an external voltage up to ± 90 V provided S1 and S3 are "OFF" to disconnect internal load resistors. (Maximum Input Voltage with S1 "ON" is ± 16 V)
- Input Impedance:** With S1 and S3 "OFF", the resistive input impedance exceeds 1 Megohm, as long as Pin 7 voltage is greater than zero and less than +12 V.

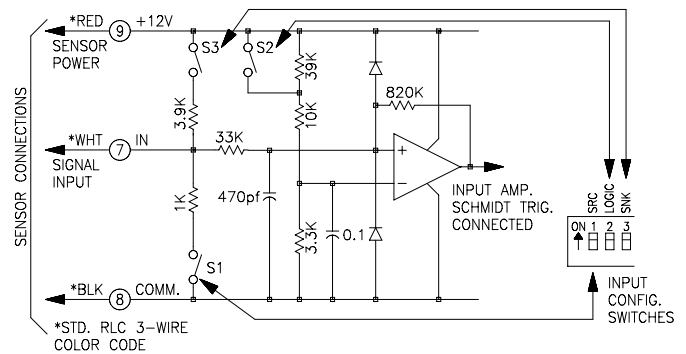

Paralleling With a Counter and/or Rate Indicator Inputs: The PRS1 and PRA1 can be operated from a common sensor with current sinking output that is also used to drive the input of a Counter or Rate Indicator. Connect Pin 8 to the Common Terminal and Pin 7 to the Input Terminal of the Counter or Rate Indicator; set S1 and S3 "OFF" and S2 "ON". DO NOT PARALLEL CONNECT THE +12V OUTPUTS (Pin 9) OF PRS1 AND PRA1 UNITS WITH THE +12V OUTPUTS OF COUNTERS, DITAKS, OR OTHER PRS1 OR PRA1 UNITS. These units have regulated supplies that will not load-share. Multiple inputs cannot be operated from sensing switches, 2-wire proximity sensors, or magnetic pickups.

CONNECTIONS & CONFIGURATION SWITCH SET-UP FOR VARIOUS SENSOR OUTPUTS

<h3>MAGNETIC PICKUPS</h3> <p>RECOMMENDED RULES FOR MAGNETIC PICKUP CONNECTIONS</p> <ol style="list-style-type: none"> Mount the PRS1 or PRA1 in a relatively "noise-free" environment, away from motor starters, control relays, or other sources of electrical interference. Use 2-wire shielded cable for magnetic pickup signal leads. Never run signal cable in conduit, troughs, or cable bundles with power carrying conductors. Connect the shield to the common Terminal "8" at the input of the PRS1 or PRA1. DO NOT connect the shield at the pickup end, leave it "open" and insulate the exposed shield to prevent electrical contact with the frame or case. (Shielded cable, supplied on some RLC magnetic pickups, has open shield on pickup end.) 	<h3>SENSORS WITH CURRENT SINK OUTPUT (NPN O.C.)</h3> <p>RLC SENSOR MODELS: ASTC, LMPC, PSAC, LSC, RPGC, RPGB, RPGH, RPGQ, HESS, etc.</p>
<h3>2-WIRE PROXIMITY SENSORS</h3>	<h3>SENSORS WITH CURRENT SOURCE OUTPUT (PNP O.C.)</h3>
<h3>OLDER STYLE RLC SENSORS WITH -EF OUTPUT</h3> <p>RLC SENSOR MODEL: LMPEC</p>	<h3>A.C. INPUTS FROM INVERTERS, A.C. TACHOMETERS GENERATORS, ETC.</h3> <p>R - Resistor to limit input current to 5 mA peak C - Filter cap required when input A.C. has "ringing" characteristics as with inverters.</p> <p>A.C. Power sources exceeding 50 V output should be coupled with an isolation transformer.</p>
<h3>INPUT FROM CMOS OR TTL</h3>	<h3>SWITCH CONTACT INPUT (Applies to PRS1 only)</h3> <p>The addition of two external resistors and a capacitor allows the PRS1 to be operated from input signals generated by a switch contact. The external RC network forms a Low-Pass Filter which operates in conjunction with the hysteresis of the input circuit to "De-bounce" the Switch Contact signal.</p> <p>Use of the Low-Pass RC Filter places a high-speed restriction on the circuit, and it cannot be used at frequencies of more than 200 to 300 cps. However, Switch Contact input is normally limited to low speed operation, so this does not impose a serious restriction.</p>

PRA1 & PRS1 SENSOR & FREQUENCY RANGE SELECTION

Both the PRA1 Pulse-Rate to Analog Converter and the PRS1 Speed-Switch normally operate from a variable frequency signal supplied by a machine mounted sensor. The sensor signal varies in frequency in direct proportion to machine speed, and may be a sinusoidal, triangular, square, or pulse-type waveform. The sensor arrangement can take a variety of forms such as a Magnetic Pickup or Proximity Sensor detecting passing teeth on a sprocket or gear, a Photo-Electric Scanner viewing passing pulley spokes, a Rotary Pulse Generator coupled to a machine shaft, or a Length Sensor driven by a web or ribbon of material passing through the machine. (See Sensor Section of the catalog for more information on sensors.)

Since both the PRA1 and PRS1 operate from the frequency content of the incoming signal, the response time of both devices is also related to the signal frequency. This gives rise to the cardinal rule of selecting a sensor arrangement:

WHEN RESPONSE TIME IS IMPORTANT, SELECT A SENSOR ARRANGEMENT & LOCATION THAT WILL PROVIDE A HIGH FREQUENCY OUTPUT AT OPERATING SPEED.

When a PRA1 or PRS1 application is first contemplated, it seems to be natural to think in terms of applying the sensor to the low speed end of the power drive train. In some cases this may be the only practical location for the sensor, and if fast response is needed from the PRA1 or PRS1, a sensor arrangement capable of delivering a high number of cycles or pulses/revolution (PPR) will be required. In a great number of applications however, generating a higher frequency sensor signal is simply a matter of locating the sensor on an intermediate or high speed shaft such as directly on the drive motor shaft.

Another advantage of moving the sensor location up toward the high speed end of the drive train is that the shaft rotary motion is usually much smoother and more regular. Slow speed shafts will often rotate irregularly due to gear backlash, "slop" in couplings, or slack in chain drives. This irregular motion can have an adverse effect on the resulting output, especially when using the PRS1 to perform a speed switching function near normal running speed.

SELECTING AN APPROPRIATE SENSOR ARRANGEMENT

There are no exact rules governing the selection of a sensor arrangement since machine geometry and conditions can vary widely from one application to the next. However, the following generalized criteria will prove useful as guidelines toward selecting the best sensor arrangement. (See Sensor Section of the catalog for more information.)

ULTRA-LOW SHAFT SPEEDS (10RPM or less) - Proximity Sensors, Photo-Electric Scanners, or Rotary Pulse Generators, are usually the best selections. In most ultra-low speed applications, it is advisable to provide as many pulses per revolution as possible (*high PPR*) to get acceptable response times.

LOW-SHAFT SPEEDS (10-100RPM) - LMPC (Super-Sensitive Magnetic Pickup), Proximity Sensors, Photo-Electric Scanners and RPG's can usually be applied in this speed range.

INTERMEDIATE SHAFT SPEEDS (10-1000RPM) - Magnetic Pickups, the LMPC, RPG's and some Proximity Sensors are appropriate at these speeds.

HIGH-SHAFT SPEEDS (1000RPM and up) - Magnetic Pickups, the LMPC and RPG's are usually the best choices.

FOR LINEAR SPEEDS ON PAPER WEBS, TEXTILE, RIBBON, STRIP AND WIRE - The LSC Length Sensor may prove desirable.

CAUTION: When selecting a sensor for operation at any speed, make sure the sensor is also capable of delivering an output for the entire speed range up through maximum machine speed.

DETERMINING SENSOR FREQUENCY OUTPUT & SELECTING THE PROPER FREQUENCY RANGE

Machine speeds are normally expressed in revolutions/minute (RPM) while the PRA1 and PRS1 have adjustable frequency ranges in cycles/second or Hz. In addition, sensor arrangements usually deliver a number of signal cycles or pulses for each shaft revolution. The following formula provides a convenient way to relate these variables:

$$\text{FRQ (CPS or Hz)} = \frac{\text{RPM} \times \text{PPR}}{60}$$

WHERE:

RPM is the speed of the shaft where the sensor is located in revolutions per minute.

PPR is the number of pulses (or cycles) produced by the sensor for one shaft revolution.

EXAMPLE 1

A machine is to be equipped with a PRS1 Speed Switch. A 42-tooth timing belt pulley is available in the power drive train, and an LMPC is to be used to sense passing teeth. The PRS1 set-point is to be adjusted to provide overspeed output when the timing belt pulley reaches 730 RPM. What should the frequency range of the PRS1 be?

$$\text{FRQ @ set-point} = \frac{730 \text{ RPM} \times 42 \text{ PPR}}{60} = 511 \text{ Hz}$$

SELECT: PRS11021 (or -2 for 230 VAC) which has an adjustable range of 100-1000 Hz.

EXAMPLE 2

A pulley with 6 spokes operates at 650 RPM maximum machine speed. The spokes are to be sensed with a Model RR Retro-Reflective Photo Sensor. The application requires a PRA1 to develop a 4-20 mA signal for a chart recorder (20 mA output at max. speed), and a PRS1 set to 5% of maximum speed for a "zero-speed" switching function. What are the frequency ranges to be used for the PRA1 and PRS1?

$$\text{FRQ @ max. speed} = \frac{650 \text{ RPM} \times 6 \text{ PPR}}{60} = 65 \text{ Hz}$$

SELECT: PRA11011 (adjustable for max. output 30-100 Hz)

$$\text{FRQ @ "zero-speed"} = 65 \times 5\% = 3.2 \text{ Hz}$$

SELECT: PRS10101 (adjustable set-point 1-10 Hz)

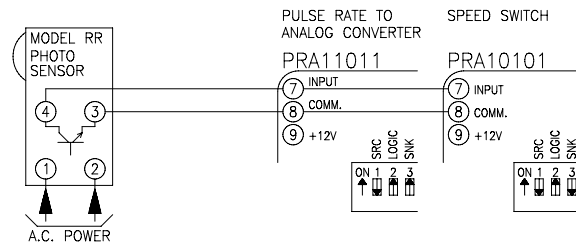

Note: The RR Photo Sensor output is limited to 5 mA max. Therefore, its output NPN Transistor is connected as a current sink output driving both PRA1 and PRS1 in parallel, and using only the pull-up resistor in the PRA1 as a load (S3 of PRA1 is ON, S3 of PRS1 is OFF). See "PRA1 & PRS1 Input Circuits, Sensor Connections & Configuration Switch Set-ups" section for more information.

EXAMPLE 3

The speed of a gravity-powered conveyor is restrained and controlled by a hydraulic brake (pump) which is coupled to a conveyor shaft. A PRA1 is to be used to supply a speed feed-back signal to the hydraulic control circuit, with 0-10 VDC corresponding to a speed range of 0-36 RPM on the conveyor shaft.

SOLUTION: Since the PRA1 is in the speed feed back control loop, fast response is important and a high PPR will be needed to minimize delay in output response. By using a 600 PPR Rotary Pulse Generator (RPGB) coupled by 3:1 speed-increasing instrument belt drive, the effective PPR of the conveyor shaft is 3 x 600 or 1800 PPR. The PRA1 input frequency then is:

$$\text{FRQ} = \frac{36 \text{ RPM (max. speed)} \times 1800 \text{ PPR}}{60} = 1080 \text{ Hz}$$

SELECT: PRA13021 (adjustable for max. output, 1-3 KHz)

Note: The smoothness of shaft motion can be a factor in this type of application. Direct coupling a high PPR Rotary Pulse Generator to a slow moving shaft that dithers or exhibits rotary oscillation can create false pulses reflected as an output that is erroneously high. A belt drive was chosen here to help dampen vibration effects. Adding some additional mass to the RPG shaft, such as a weighted drive pulley, will increase the inertia and dampen oscillation even further.