

FEATURES

- 12-bit, 80 MSPS output data rate per channel
- 1.8 V analog supply operation (AVDD)
- 1.8 V to 3.3 V output supply (DRVDD)
- Integrated noise shaping requantizer (NSR)
- Integrated quadrature error correction (QEC)
- Performance with NSR enabled
 - SNR = 81 dBFS in 16 MHz band up to 30 MHz at 80 MSPS
- Performance with NSR disabled
 - SNR = 72 dBFS up to 70 MHz at 80 MSPS
 - SFDR = 90 dBc up to 70 MHz input at 80 MSPS
- Low power: 98 mW per channel at 80 MSPS
- Differential input with 700 MHz bandwidth
- On-chip voltage reference and sample-and-hold circuit
- 2 V p-p differential analog input
- Serial port control options
 - Offset binary, gray code, or twos complement data format
 - Optional clock duty cycle stabilizer
 - Integer 1-to-6 input clock divider
 - Data output multiplex option
 - Built-in selectable digital test pattern generation
 - Energy-saving power-down modes
 - Data clock out with programmable clock and data alignment

APPLICATIONS

- Communications
- Diversity radio systems
- Multimode digital receivers
 - 3G, W-CDMA, LTE, CDMA2000, TD-SCDMA, MC-GSM
- I/Q demodulation systems
- Smart antenna systems
- Battery-powered instruments
- General-purpose software radios

FUNCTIONAL BLOCK DIAGRAM

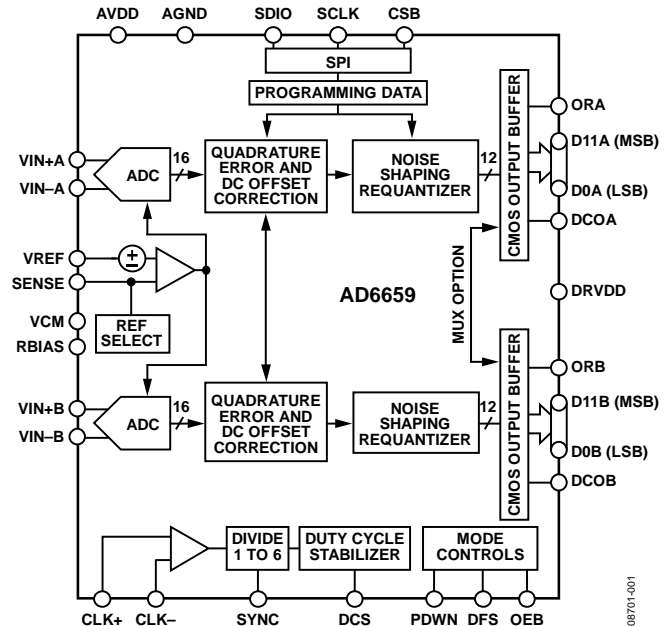

Figure 1.

PRODUCT HIGHLIGHTS

1. The AD6659 operates from a single 1.8 V analog power supply and features a separate digital output driver supply to accommodate 1.8 V to 3.3 V logic families.
2. SPI-selectable noise shaping requantizer (NSR) function that allows for improved SNR within a reduced bandwidth of up to 70 MHz at 80 MSPS.
3. SPI-selectable dc correction and quadrature error correction (QEC) that corrects for dc offset, gain, and phase mismatches between the two channels.
4. A standard serial port interface supports various product features and functions, such as data output formatting, internal clock divider, power-down, DCO/data timing, offset adjustments, and voltage reference modes.
5. The AD6659 is packaged in a 64-lead RoHS-compliant LFCSP that is pin compatible with the AD9269 16-bit ADC, the AD9268 16-bit ADC, the AD9258 14-bit ADC, the AD9251 14-bit ADC, the AD9231 12-bit ADC, and the AD9204 10-bit ADC, enabling a simple migration path between 10-bit and 16-bit converters sampling from 20 MSPS to 125 MSPS.

Rev. A

Information furnished by Analog Devices is believed to be accurate and reliable. However, no responsibility is assumed by Analog Devices for its use, nor for any infringements of patents or other rights of third parties that may result from its use. Specifications subject to change without notice. No license is granted by implication or otherwise under any patent or patent rights of Analog Devices. Trademarks and registered trademarks are the property of their respective owners.

TABLE OF CONTENTS

Features	1	Digital Outputs	22
Applications	1	Timing	22
Functional Block Diagram	1	Built-In Self-Test and Output Test	24
Product Highlights	1	BIST	24
Revision History	2	Output Test Modes	24
General Description	3	Channel/Chip Synchronization	25
Specifications	4	Noise Shaping Requantizer (NSR)	26
DC Specifications	4	20% BW NSR Mode (16 MHz BW at 80 MSPS)	26
AC Specifications	5	DC and Quadrature Error Correction (QEC)	27
Digital Specifications	6	Serial Port Interface (SPI)	29
Switching Specifications	7	Configuration Using the SPI	29
Timing Specifications	8	Hardware Interface	30
Absolute Maximum Ratings	9	Configuration Without the SPI	30
Thermal Characteristics	9	SPI Accessible Features	30
ESD Caution	9	Memory Map	31
Pin Configuration and Function Descriptions	10	Reading the Memory Map Register Table	31
Typical Performance Characteristics	12	Open Locations	31
Equivalent Circuits	14	Default Values	31
Theory of Operation	16	Memory Map Register Table	32
ADC Architecture	16	Memory Map Register Descriptions	35
Analog Input Considerations	16	Applications Information	37
Voltage Reference	19	Design Guidelines	37
Clock Input Considerations	20	Outline Dimensions	38
Power Dissipation and Standby Mode	21	Ordering Guide	38

REVISION HISTORY

2/10—Rev. 0 to Rev. A

Changes to Title	1
Changes to Features Section	1
Changes to General Description Section	3

1/10—Revision 0: Initial Version

GENERAL DESCRIPTION

The AD6659 is a mixed-signal, dual-channel IF receiver supporting radio topologies requiring two receiver signal paths, such as in main/diversity or direct conversion. This communications systems processor consists of two high performance analog-to-digital converters (ADCs) and noise shaping requantizer (NSR) digital blocks. It is designed to support various communications applications where high dynamic range performance and small size are desired.

The high dynamic range ADC core features a multistage differential pipelined architecture with integrated output error correction logic. Each ADC features a wide bandwidth switch capacitor sampling network within the first stage of the differential pipeline. An integrated voltage reference eases design considerations.

Each ADC output is connected internally to an NSR block. The integrated NSR circuitry allows for improved SNR performance in a smaller frequency band within the Nyquist region. The device supports two different output modes selectable via the serial port interface (SPI).

With the NSR feature enabled, the outputs of the ADCs are processed such that the AD6659 supports enhanced SNR performance within a limited region of the Nyquist bandwidth while maintaining a 12-bit output resolution. The NSR block is programmed to provide a bandwidth of 20% of the sample clock. For example, with a sample clock rate of 80 MSPS, the AD6659 can achieve up to 81.5 dBFS SNR for a 16 MHz bandwidth at 9.7 MHz AIN.

With the NSR block disabled, the ADC data is provided directly to the output with an output resolution of 12 bits. The AD6659 can achieve up to 72 dBFS SNR for the entire Nyquist bandwidth when operated in this mode.

After digital processing, output data is routed into two 12-bit output ports that support 1.8 V or 3.3 V CMOS levels.

The AD6659 receiver digitizes a wide spectrum of IF frequencies. Each receiver is designed for simultaneous reception of the main and diversity channel. This IF sampling architecture greatly reduces component cost and complexity compared with traditional analog techniques or less integrated digital methods.

The AD6659 also incorporates an optional integrated dc offset correction and quadrature error correction (QEC) block that corrects for gain and phase mismatch between the two channels. This functional block proves invaluable in complex signal processing applications such as direct conversion receivers.

The ADC contains several features designed to maximize flexibility and minimize system cost, such as programmable clock and data alignment and programmable digital test pattern generation. The available digital test patterns include built-in deterministic and pseudorandom patterns, along with custom user-defined test patterns entered via the serial port interface (SPI).

A differential clock input controls all internal conversion cycles. An optional duty cycle stabilizer (DCS) compensates for wide variations in the clock duty cycle while maintaining excellent overall ADC performance.

The digital output data is presented in offset binary, gray code, or twos complement format. A data clock output (DCO) is provided for each ADC channel to ensure proper latch timing with receiving logic. Both 1.8 V and 3.3 V CMOS levels are supported, and output data can be multiplexed onto a single output bus.

The AD6659 is available in a 64-lead, RoHS-compliant LFCSP, and it is specified over the industrial temperature range (-40°C to $+85^{\circ}\text{C}$).

AD6659

SPECIFICATIONS

DC SPECIFICATIONS

AVDD = 1.8 V; DRVDD = 1.8 V, maximum sample rate, 2 V p-p differential input, 1.0 V internal reference; AIN = -1.0 dBFS, DCS disabled, unless otherwise noted.

Table 1.

Parameter	Temp	Min	Typ	Max	Unit
RESOLUTION	Full	12			Bits
ACCURACY					
No Missing Codes	Full		Guaranteed		
Offset Error	Full		±0.05	±0.5	% FSR
Gain Error ¹	Full		-1.9		% FSR
Differential Nonlinearity (DNL) ²	Full			±0.30	LSB
	25°C		±0.13		LSB
Integral Nonlinearity (INL) ²	Full			±0.40	LSB
	25°C		±0.17		LSB
MATCHING CHARACTERISTICS					
Offset Error	25°C		±0.0	±0.65	% FSR
Gain Error ¹	25°C		0.4		% FSR
TEMPERATURE DRIFT					
Offset Error	Full		±2		ppm/°C
INTERNAL VOLTAGE REFERENCE					
Output Voltage (1 V Mode)	Full	0.981	0.993	1.005	V
Load Regulation Error at 1.0 mA	Full		2		mV
INPUT REFERRED NOISE					
VREF = 1.0 V	25°C		0.25		LSB rms
ANALOG INPUT					
Input Span, VREF = 1.0 V	Full		2		V p-p
Input Capacitance ³	Full		6.5		pF
Input Common-Mode Voltage	Full		0.9		V
Input Common-Mode Range	Full	0.5		1.3	V
REFERENCE INPUT RESISTANCE	Full		7.5		kΩ
POWER SUPPLIES					
Supply Voltage					
AVDD	Full	1.7	1.8	1.9	V
DRVDD	Full	1.7		3.6	V
Supply Current					
IAVDD ²	Full		113	119	mA
IDRVDD ² (1.8 V)	Full		9.3		mA
IDRVDD ² (3.3 V)	Full		18.5		mA
POWER CONSUMPTION					
DC Input	Full		196		mW
Sine Wave Input ² (DRVDD = 1.8 V)	Full		220	240	mW
Sine Wave Input ² (DRVDD = 3.3 V)	Full		264		mW
Standby Power ⁴	Full		37		mW
Power-Down Power	Full		1.0		mW

¹ Measured with 1.0 V external reference.

² Measured with a 10 MHz input frequency at rated sample rate, full-scale sine wave, with approximately 5 pF loading on each output bit.

³ Input capacitance refers to the effective capacitance between one differential input pin and AGND.

⁴ Standby power is measured with a dc input and the CLK active.

AC SPECIFICATIONS

AVDD = 1.8 V; DRVDD = 1.8 V, maximum sample rate, 2 V p-p differential input, 1.0 V internal reference; AIN = -1.0 dBFS, DCS disabled, unless otherwise noted.

Table 2.

Parameter ¹	Temp	Min	Typ	Max	Unit
SIGNAL-TO-NOISE RATIO (SNR)—NSR DISABLED					
$f_{IN} = 9.7$ MHz	25°C		72.4		dBFS
$f_{IN} = 30.5$ MHz	25°C		72.3		dBFS
$f_{IN} = 70$ MHz	25°C		72.0		dBFS
	Full	71.4			dBFS
SIGNAL-TO-NOISE RATIO (SNR)—NSR ENABLED					
20% Bandwidth (16 MHz @ 80 MSPS)					
$f_{IN} = 9.7$ MHz	25°C		81.5		dBFS
$f_{IN} = 30.5$ MHz	25°C		81.2		dBFS
$f_{IN} = 70$ MHz	25°C		80.3		dBFS
SIGNAL-TO-NOISE-AND-DISTORTION (SINAD)					
$f_{IN} = 9.7$ MHz	25°C		72.4		dBFS
$f_{IN} = 30.5$ MHz	25°C		72.2		dBFS
$f_{IN} = 70$ MHz	25°C		71.9		dBFS
	Full	71.5			dBFS
EFFECTIVE NUMBER OF BITS (ENOB)					
$f_{IN} = 9.7$ MHz	25°C		11.7		Bits
$f_{IN} = 30.5$ MHz	25°C		11.7		Bits
$f_{IN} = 70$ MHz	25°C		11.7		Bits
WORST SECOND OR THIRD HARMONIC					
$f_{IN} = 9.7$ MHz	25°C		-93		dBc
$f_{IN} = 30.5$ MHz	25°C		-92		dBc
$f_{IN} = 70$ MHz	25°C		-90		dBc
	Full			-80	dBc
SPURIOUS-FREE DYNAMIC RANGE (SFDR)					
$f_{IN} = 9.7$ MHz	25°C		93		dBc
$f_{IN} = 30.5$ MHz	25°C		92		dBc
$f_{IN} = 70$ MHz	25°C		90		dBc
	Full	80			dBc
WORST OTHER (HARMONIC OR SPUR)					
$f_{IN} = 9.7$ MHz	25°C		-99		dBc
$f_{IN} = 30.5$ MHz	25°C		-99		dBc
$f_{IN} = 70$ MHz	25°C		-98		dBc
	Full			-91	dBc
TWO-TONE SFDR					
$f_{IN} = 28.3$ MHz (-7 dBFS), 30.6 MHz (-7 dBFS)	25°C		90		dBc
CROSSTALK ²	Full		-110		dBc
ANALOG INPUT BANDWIDTH	25°C		700		MHz

¹ See the AN-835 Application Note, *Understanding High Speed ADC Testing and Evaluation*, for a complete set of definitions.

² Crosstalk is measured at 100 MHz with -1.0 dBFS on one channel and no input on the alternate channel.

AD6659

DIGITAL SPECIFICATIONS

AVDD = 1.8 V; DRVDD = 1.8 V, maximum sample rate, 2 V p-p differential input, 1.0 V internal reference; AIN = -1.0 dBFS, DCS disabled, unless otherwise noted.

Table 3.

Parameter	Temp	Min	Typ	Max	Unit
DIFFERENTIAL CLOCK INPUTS (CLK+, CLK-)					
Logic Compliance			CMOS/LVDS/LVPECL		
Internal Common-Mode Bias	Full		0.9		V
Differential Input Voltage	Full	0.2		3.6	V p-p
Input Voltage Range	Full	GND - 0.3		AVDD + 0.2	V
High Level Input Current	Full	-10		+10	μA
Low Level Input Current	Full	-10		+10	μA
Input Resistance	Full	8	10	12	kΩ
Input Capacitance	Full		4		pF
LOGIC INPUTS (SCLK/DFS, SYNC, PDWN)¹					
High Level Input Voltage	Full	1.2		DRVDD + 0.3	V
Low Level Input Voltage	Full	0		0.8	V
High Level Input Current	Full	-50		-75	μA
Low Level Input Current	Full	-10		+10	μA
Input Resistance	Full		30		kΩ
Input Capacitance	Full		2		pF
LOGIC INPUTS (CSB)²					
High Level Input Voltage	Full	1.2		DRVDD + 0.3	V
Low Level Input Voltage	Full	0		0.8	V
High Level Input Current	Full	-10		+10	μA
Low Level Input Current	Full	40		135	μA
Input Resistance	Full		26		kΩ
Input Capacitance	Full		2		pF
LOGIC INPUTS (SDIO¹/DCS²)					
High Level Input Voltage	Full	1.2		DRVDD + 0.3	V
Low Level Input Voltage	Full	0		0.8	V
High Level Input Current	Full	-10		+10	μA
Low Level Input Current	Full	40		130	μA
Input Resistance	Full		26		kΩ
Input Capacitance	Full		5		pF
DIGITAL OUTPUTS					
DRVDD = 3.3 V					
High Level Output Voltage, I _{OH} = 50 μA	Full	3.29			V
High Level Output Voltage, I _{OH} = 0.5 mA	Full	3.25			V
Low Level Output Voltage, I _{OL} = 1.6 mA	Full			0.2	V
Low Level Output Voltage, I _{OL} = 50 μA	Full			0.05	V
DRVDD = 1.8 V					
High Level Output Voltage, I _{OH} = 50 μA	Full	1.79			V
High Level Output Voltage, I _{OH} = 0.5 mA	Full	1.75			V
Low Level Output Voltage, I _{OL} = 1.6 mA	Full			0.2	V
Low Level Output Voltage, I _{OL} = 50 μA	Full			0.05	V

¹ Internal 30 kΩ pull-down.

² Internal 30 kΩ pull-up.

SWITCHING SPECIFICATIONS

AVDD = 1.8 V; DRVDD = 1.8 V, maximum sample rate, 2 V p-p differential input, 1.0 V internal reference; AIN = -1.0 dBFS, DCS disabled, unless otherwise noted.

Table 4.

Parameter	Temp	Min	Typ	Max	Unit
CLOCK INPUT PARAMETERS					
Input Clock Rate	Full			480	MHz
Conversion Rate ¹	Full	3		80	MSPS
CLK Period—Divide-by-1 Mode (t_{CLK})	Full	12.5			ns
CLK Pulse Width High (t_{CH})	Full		6.25		ns
Aperture Delay (t_A)	Full		1.0		ns
Aperture Uncertainty (Jitter, t_j)	Full		0.1		ps rms
DATA OUTPUT PARAMETERS					
Data Propagation Delay (t_{PD})	Full		3		ns
DCO Propagation Delay (t_{DCO})	Full		3		ns
DCO to Data Skew (t_{SKEW})	Full		0.1		ns
Pipeline Delay (Latency)	Full		9		Cycles
With NSR Enabled	Full		10		Cycles
With QEC Enabled	Full		11		Cycles
Wake-Up Time ²	Full		350		μ s
Standby	Full		260		ns
OUT-OF-RANGE RECOVERY TIME	Full		2		Cycles

¹ Conversion rate is the clock rate after the CLK divider.

² Wake-up time is dependent on the value of the decoupling capacitors.

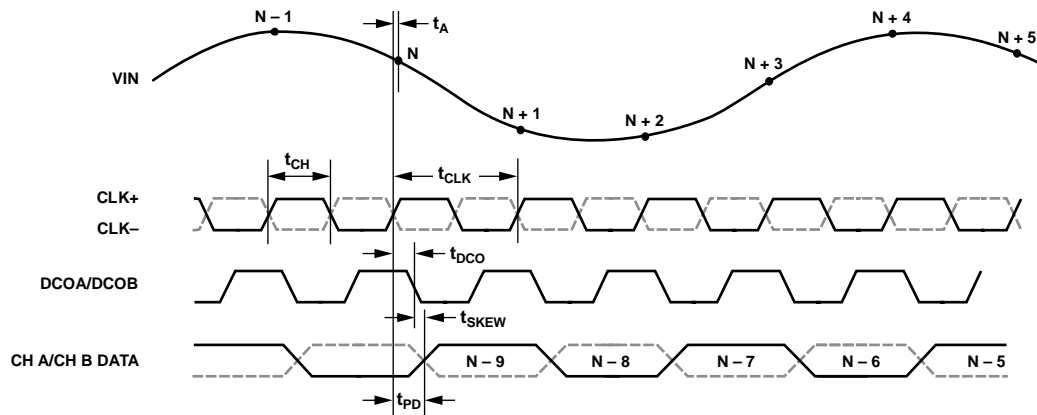

Figure 2. CMOS Output Data Timing

06701-002

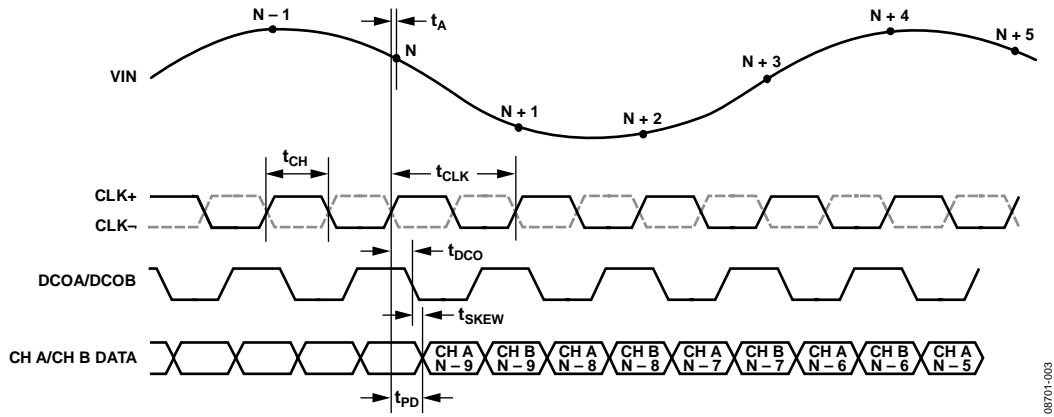

Figure 3. CMOS Interleaved Output Timing

08701-003

TIMING SPECIFICATIONS

Table 5.

Parameter	Test Conditions/Comments	Min	Typ	Max	Unit
SYNC TIMING REQUIREMENTS					
t_{SSYNC}	SYNC to rising edge of CLK setup time (see Figure 4)		0.24		ns
t_{HSYNC}	SYNC to rising edge of CLK hold time (see Figure 4)		0.40		ns
SPI TIMING REQUIREMENTS					
t_{DS}	Setup time between the data and the rising edge of SCLK (see Figure 50)	2			ns
t_{DH}	Hold time between the data and the rising edge of SCLK (see Figure 50)	2			ns
t_{CLK}	Period of the SCLK (see Figure 50)	40			ns
t_S	Setup time between CSB and SCLK (see Figure 50)	2			ns
t_H	Hold time between CSB and SCLK (see Figure 50)	2			ns
t_{HIGH}	SCLK pulse width high (see Figure 50)	10			ns
t_{LOW}	SCLK pulse width low (see Figure 50)	10			ns
t_{EN_SDIO}	Time required for the SDIO pin to switch from an input to an output relative to the SCLK falling edge	10			ns
t_{DIS_SDIO}	Time required for the SDIO pin to switch from an output to an input relative to the SCLK rising edge	10			ns

Timing Diagram

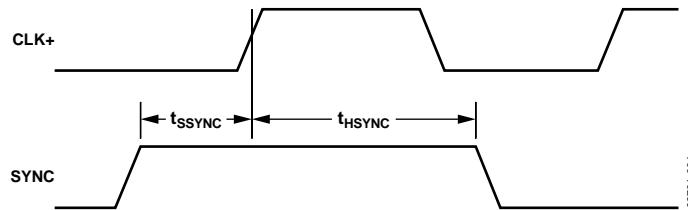

Figure 4. SYNC Input Timing Requirements

08701-004

ABSOLUTE MAXIMUM RATINGS

Table 6.

Parameter	Rating
AVDD to AGND	−0.3 V to +2.0 V
DRVDD to AGND	−0.3 V to +3.9 V
VIN+A, VIN+B, VIN−A, VIN−B to AGND	−0.3 V to AVDD + 0.2 V
CLK+, CLK− to AGND	−0.3 V to AVDD + 0.2 V
SYNC to AGND	−0.3 V to DRVDD + 0.3 V
VREF to AGND	−0.3 V to AVDD + 0.2 V
SENSE to AGND	−0.3 V to AVDD + 0.2 V
VCM to AGND	−0.3 V to AVDD + 0.2 V
RBIAS to AGND	−0.3 V to AVDD + 0.2 V
CSB to AGND	−0.3 V to DRVDD + 0.3 V
SCLK/DFS to AGND	−0.3 V to DRVDD + 0.3 V
SDIO/DCS to AGND	−0.3 V to DRVDD + 0.3 V
OEB to AGND	−0.3 V to DRVDD + 0.3 V
PDWN to AGND	−0.3 V to DRVDD + 0.3 V
D0x through D11x to AGND	−0.3 V to DRVDD + 0.3 V
DCOx to AGND	−0.3 V to DRVDD + 0.3 V
Operating Temperature Range (Ambient)	−40°C to +85°C
Maximum Junction Temperature Under Bias	150°C
Storage Temperature Range (Ambient)	−65°C to +150°C

Stresses above those listed under Absolute Maximum Ratings may cause permanent damage to the device. This is a stress rating only; functional operation of the device at these or any other conditions above those indicated in the operational section of this specification is not implied. Exposure to absolute maximum rating conditions for extended periods may affect device reliability.

THERMAL CHARACTERISTICS

The exposed paddle is the only ground connection for the chip. The exposed paddle must be soldered to the AGND plane of the user's circuit board. Soldering the exposed paddle to the user's board also increases the reliability of the solder joints and maximizes the thermal capability of the package.

Typical θ_{JA} is specified for a 4-layer PCB with a solid ground plane. As listed in Table 7, airflow improves heat dissipation, which reduces θ_{JA} . In addition, metal in direct contact with the package leads from metal traces, through holes, ground, and power planes, reduces the θ_{JA} .

Table 7. Thermal Resistance

Package Type	Airflow Velocity (m/sec)	$\theta_{JA}^{1,2}$	$\theta_{JC}^{1,3}$	$\theta_{JB}^{1,4}$
64-Lead LFCSP 9 mm × 9 mm (CP-64-4)	0	23°C/W	2.0°C/W	12°C/W
	1.0	20°C/W		
	2.5	18°C/W		

¹ Per JEDEC 51-7, plus JEDEC 25-5 2S2P test board.

² Per JEDEC JESD51-2 (still air) or JEDEC JESD51-6 (moving air).

³ Per MIL-STD 883, Method 1012.1.

⁴ Per JEDEC JESD51-8 (still air).

ESD CAUTION



ESD (electrostatic discharge) sensitive device. Charged devices and circuit boards can discharge without detection. Although this product features patented or proprietary protection circuitry, damage may occur on devices subjected to high energy ESD. Therefore, proper ESD precautions should be taken to avoid performance degradation or loss of functionality.

PIN CONFIGURATION AND FUNCTION DESCRIPTIONS

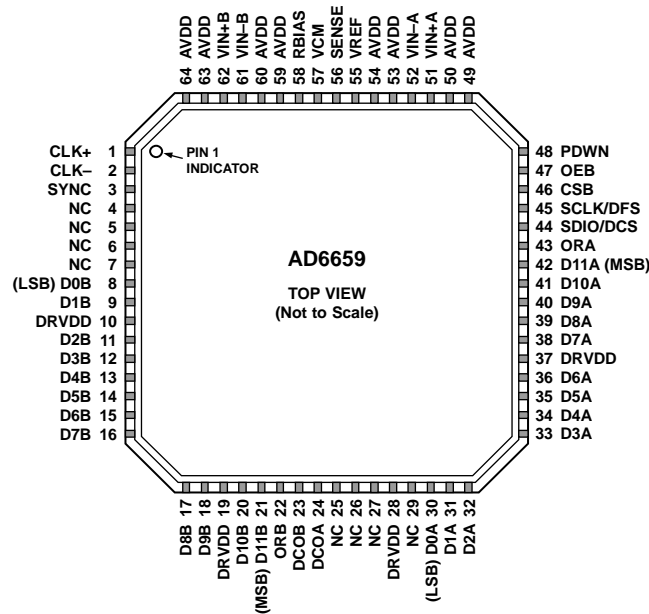

- NOTES**
1. NC = NO CONNECT.
 2. THE EXPOSED PADDLE MUST BE SOLDERED TO THE PCB GROUND TO ENSURE PROPER HEAT DISSIPATION, NOISE, AND MECHANICAL STRENGTH BENEFITS.

08701-005

Figure 5. Pin Configuration

Table 8. Pin Function Descriptions

Pin No.	Mnemonic	Description
0, EP	AGND	Exposed paddle is the only ground connection for the chip. It must be connected to the printed circuit board (PCB) AGND.
1, 2	CLK+, CLK-	Differential Encode Clock. PECL, LVDS, or 1.8 V CMOS inputs.
3	SYNC	Digital Input. SYNC input to clock divider. 30 kΩ internal pull-down.
4 to 7, 25 to 27, 29	NC	Do Not Connect.
8, 9, 11 to 18, 20, 21	D0B to D11B	Channel B Digital Outputs. D11B is the MSB and D0B is the LSB.
10, 19, 28, 37	DRVDD	Digital Output Driver Supply (1.8 V to 3.3 V).
22	ORB	Channel B Out-of-Range Digital Output.
23	DCOB	Channel B Data Clock Digital Output.
24	DCOA	Channel A Data Clock Digital Output.
30 to 36, 38 to 42	D0A to D11A	Channel A Digital Outputs. D11A is the MSB and D0A is the LSB.
43	ORA	Channel A Out-of-Range Digital Output.
44	SDIO/DCS	SPI Data Input/Output (SDIO). The SDIO function provides bidirectional SPI data I/O in SPI mode with a 30 kΩ internal pull-down in SPI mode. The duty cycle stabilizer (DCS pin function) is the static enable input for the duty cycle stabilizer in non-SPI mode with a 30 kΩ internal pull-up in non-SPI (DCS) mode.
45	SCLK/DFS	SPI Clock (SCLK) Input in SPI Mode/Data Format Select (DFS). 30 kΩ internal pull-down for both SCLK and DFS. The DFS function provides static control of data output format in non-SPI mode. When DFS is high, it equals twos complement output. When DFS is low, it equals offset binary output.
46	CSB	SPI Chip Select. Active low enable; 30 kΩ internal pull-up.
47	OEB	Digital Input. When OEB is low, it enables the Channel A and Channel B digital outputs; when OEB is high, the outputs are tristated. 30 kΩ internal pull-down.
48	PDWN	Digital Input. 30 kΩ internal pull-down. When PDWN is high, it powers down the device. When PDWN is low, the device runs in normal operation.

Pin No.	Mnemonic	Description
49, 50, 53, 54, 59, 60, 63, 64	AVDD	1.8 V Analog Supply Pins.
51, 52	VIN+A, VIN-A	Channel A Analog Inputs.
55	VREF	Voltage Reference Input/Output.
56	SENSE	Reference Mode Selection.
57	VCM	Analog output voltage at midsupply to set common mode of the analog inputs.
58	RBIAS	Sets Analog Current Bias. Connect to a 10 k Ω (1% tolerance) resistor to ground.
61, 62	VIN-B, VIN+B	Channel B Analog Inputs.

TYPICAL PERFORMANCE CHARACTERISTICS

AVDD = 1.8 V; DRVDD = 1.8 V, maximum sample rate, 2 V p-p differential input, 1.0 V internal reference; AIN = -1.0 dBFS, DCS disabled, unless otherwise noted.

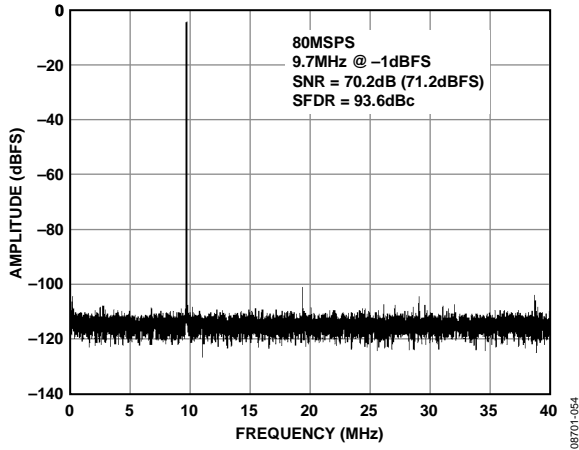

Figure 6. Single-Tone FFT with $f_{IN} = 9.7$ MHz

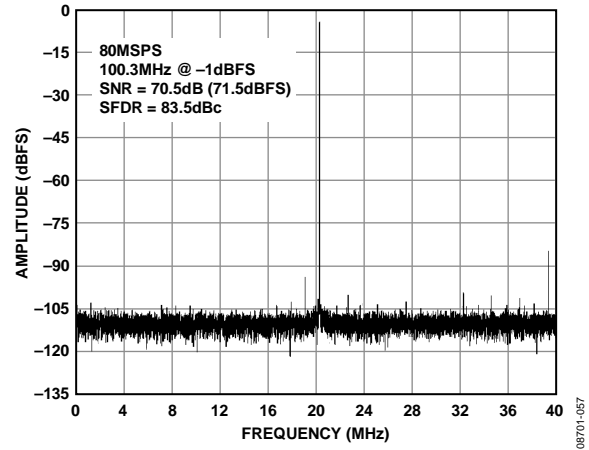

Figure 9. Single-Tone FFT with $f_{IN} = 100.3$ MHz

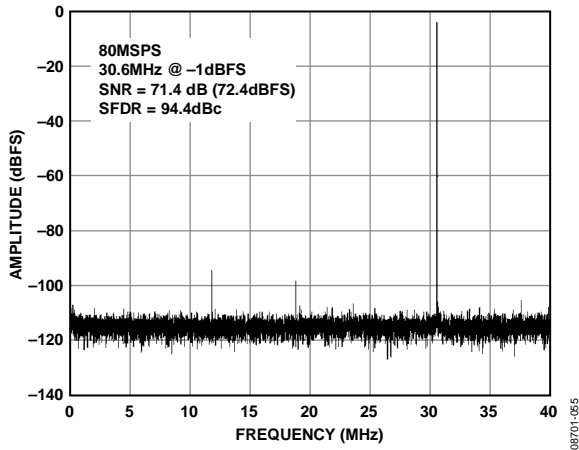

Figure 7. Single-Tone FFT with $f_{IN} = 30.6$ MHz

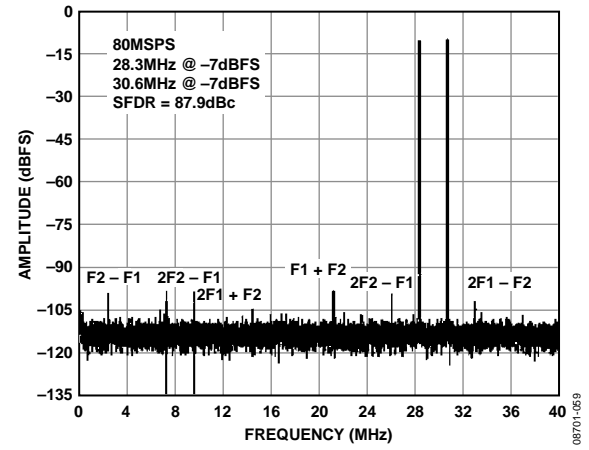

Figure 10. Two-Tone FFT with $f_{IN1} = 28.3$ MHz and $f_{IN2} = 30.6$ MHz

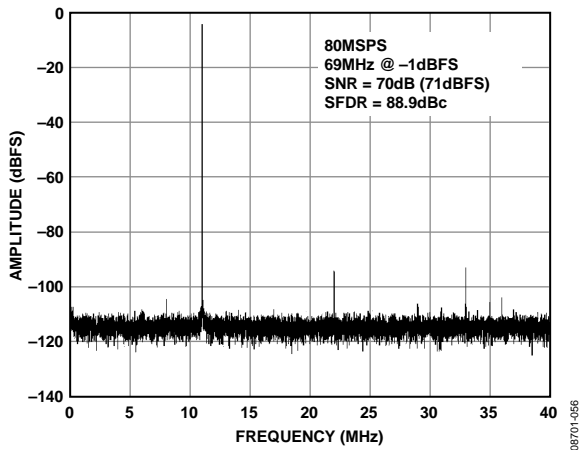

Figure 8. Single-Tone FFT with $f_{IN} = 69$ MHz

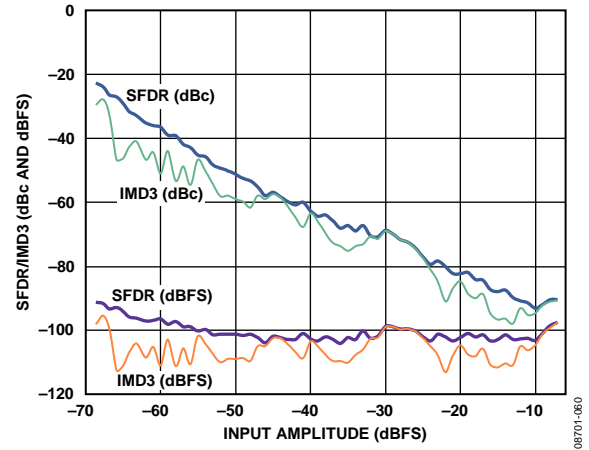

Figure 11. Two-Tone SFDR/IMD3 vs. Input Amplitude (AIN) with $f_{IN1} = 28.3$ MHz and $f_{IN2} = 30.6$ MHz

AVDD = 1.8 V; DRVDD = 1.8 V, maximum sample rate, 2 V p-p differential input, 1.0 V internal reference; AIN = -1.0 dBFS, DCS disabled, unless otherwise noted.

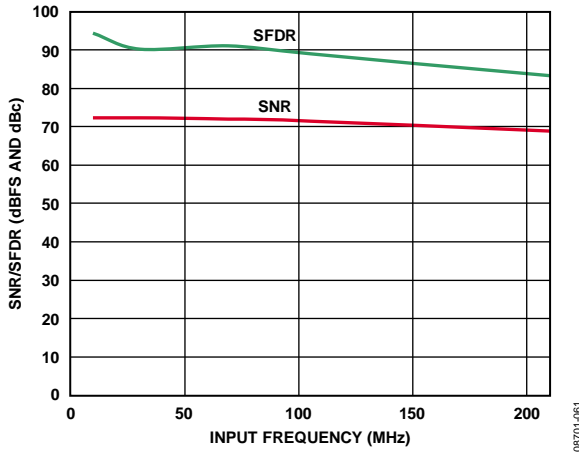

Figure 12. SNR/SFDR vs. Input Frequency (AIN) with 2 V p-p Full Scale

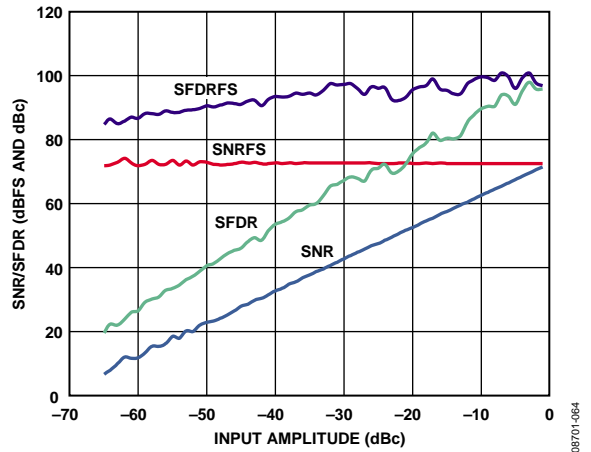

Figure 15. SNR/SFDR vs. Input Amplitude (AIN) with $f_{IN} = 9.7$ MHz

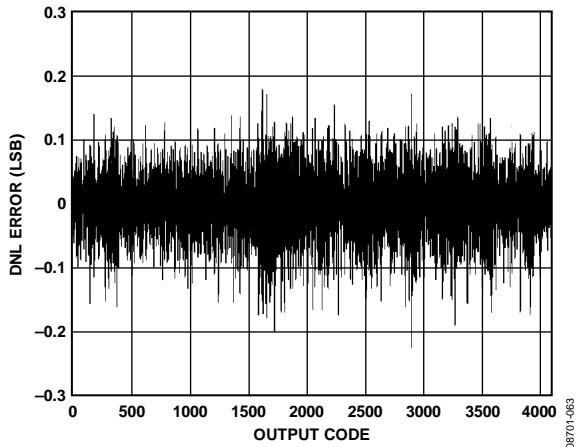

Figure 13. DNL Error with $f_{IN} = 9.7$ MHz

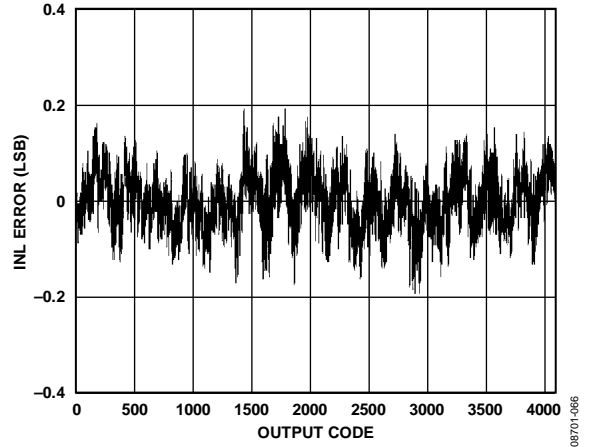

Figure 16. INL Error with $f_{IN} = 9.7$ MHz

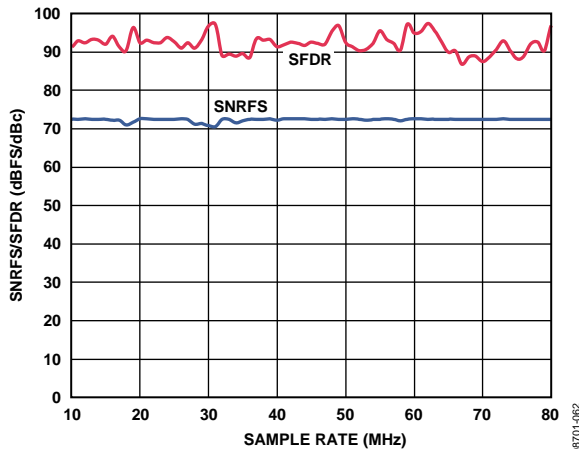

Figure 14. SNR/SFDR vs. Sample Rate with AIN = 9.7 MHz

EQUIVALENT CIRCUITS

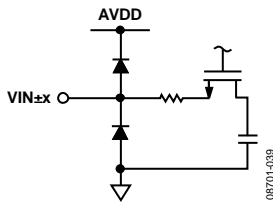

Figure 17. Equivalent Analog Input Circuit

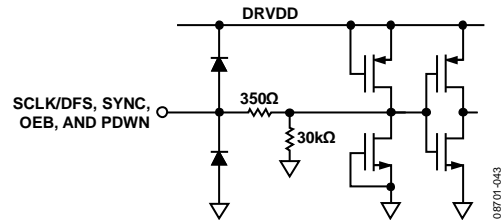

Figure 21. Equivalent SCLK/DFS, SYNC, OEB, and PDWN Input Circuit

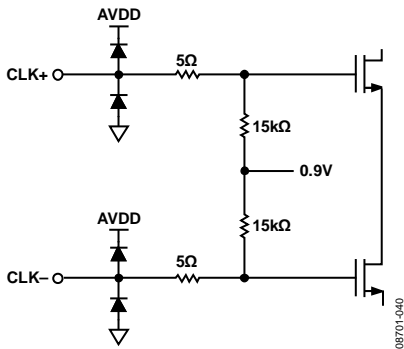

Figure 18. Equivalent Clock Input Circuit

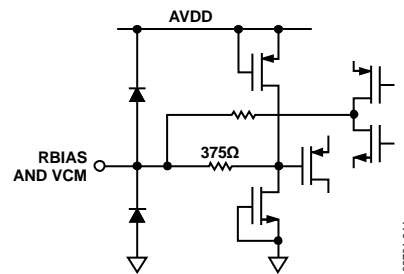

Figure 22. Equivalent RBIAS and VCM Circuit

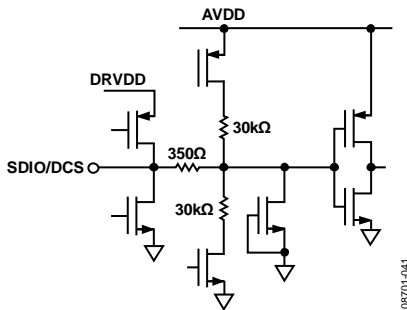

Figure 19. Equivalent SDIO/DCS Input Circuit

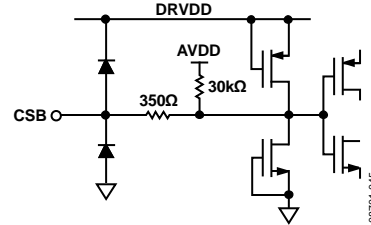

Figure 23. Equivalent CSB Input Circuit

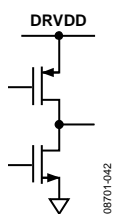

Figure 20. Equivalent Digital Output Circuit

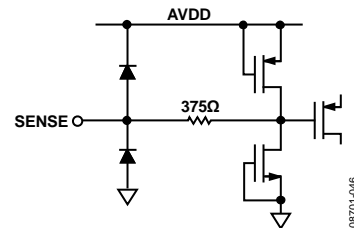

Figure 24. Equivalent SENSE Circuit

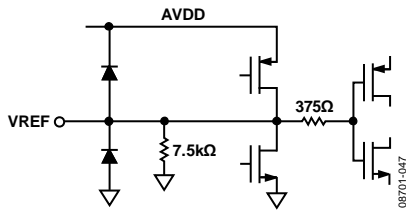

Figure 25. Equivalent VREF Circuit

THEORY OF OPERATION

The AD6659 dual ADC design can be used for diversity reception of signals, where the ADCs are operating identically on the same carrier but from two separate antennae. The ADCs can be operated with independent analog inputs. The user can sample any $f_s/2$ frequency segment from dc to 200 MHz, using appropriate low-pass or band-pass filtering at the ADC inputs with little loss in ADC performance. Operation to 300 MHz analog input is permitted but occurs at the expense of increased ADC noise and distortion.

In nondiversity applications, the AD6659 can be used as a base-band or direct downconversion receiver, where one ADC is used for I input data and the other ADC is used for Q input data.

Synchronization capability is provided to allow synchronized timing between multiple channels or multiple devices.

The AD6659 features a noise shaping requantizer (NSR) to allow higher than 12-bit SNR to be maintained in a subset of the Nyquist band.

The AD6659 also incorporates an optional integrated dc offset correction and quadrature error correction (QEC) block that can correct for dc offset, gain, and phase mismatch between the two channels. This functional block can be very beneficial to complex signal processing applications such as direct conversion receivers.

Programming and control of the AD6659 is accomplished using a 3-wire, SPI-compatible serial interface.

ADC ARCHITECTURE

The AD6659 architecture consists of a multistage, pipelined ADC. Each stage provides sufficient overlap to correct for flash errors in the preceding stage. The quantized outputs from each stage are combined into a final 12-bit result in the digital correction logic. Alternately, the 12-bit result can be processed through the noise shaping requantizer (NSR) block before it is sent to the digital correction logic.

The pipelined architecture permits the first stage to operate with a new input sample while the remaining stages operate with preceding samples. Sampling occurs on the rising edge of the clock.

Each stage of the pipeline, excluding the last, consists of a low resolution flash ADC connected to a switched capacitor DAC and an interstage residue amplifier (for example, a multiplying digital-to-analog converter (MDAC)). The residue amplifier magnifies the difference between the reconstructed DAC output and the flash input for the next stage in the pipeline. One bit of redundancy is used in each stage to facilitate digital correction of flash errors. The last stage simply consists of a flash ADC.

Each ADC output is connected internally to an NSR block. The integrated NSR circuitry allows for improved SNR performance in a smaller frequency band within the Nyquist region. The device supports two different output modes selectable via the SPI. With the NSR feature enabled, the outputs of the ADCs are processed such that the AD6659 supports enhanced SNR performance within a limited region of the Nyquist bandwidth while maintaining a 12-bit output resolution. With the NSR block disabled, the ADC data is provided directly to the output with an output resolution of 12 bits. The output staging block aligns the data, corrects errors, and passes the data to the CMOS output buffers. The output buffers are powered from a separate (DRVDD) supply, allowing adjustment of the output voltage swing. During power-down, the output buffers go into a high impedance state.

ANALOG INPUT CONSIDERATIONS

The analog input to the AD6659 is a differential switched capacitor circuit designed for processing differential input signals. This circuit can support a wide common-mode range while maintaining excellent performance. By using an input common-mode voltage of midsupply, users can minimize signal dependent errors and achieve optimum performance.

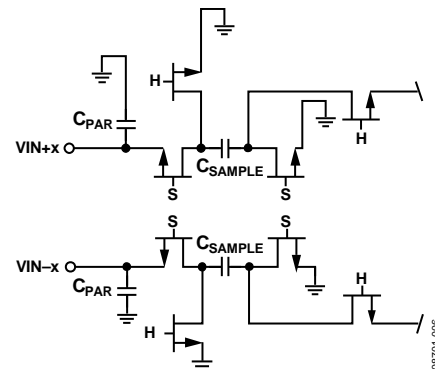

Figure 26. Switched Capacitor Input Circuit

The clock signal alternately switches the input circuit between sample and hold mode (see Figure 26). When the input circuit is switched to sample mode, the signal source must be capable of charging the sample capacitors and settling within one-half of a clock cycle. A small resistor in series with each input can help reduce the peak transient current injected from the output stage of the driving source. In addition, low Q inductors or ferrite beads can be placed on each leg of the input to reduce high differential capacitance at the analog inputs and, therefore, achieve the maximum bandwidth of the ADC. Such use of low Q inductors or ferrite beads is required when driving the converter front end at high IF frequencies. Either a shunt capacitor or two single-ended capacitors can be placed on the inputs to provide a matching passive network. This ultimately creates a low-pass filter at the input to limit unwanted broadband noise. See the

AN-742 Application Note, the AN-827 Application Note, and the *Analog Dialogue* article “Transformer-Coupled Front-End for Wideband A/D Converters” (Volume 39, April 2005) for more information. In general, the precise values depend on the application.

Input Common Mode

The analog inputs of the AD6659 are not internally dc-biased. Therefore, in ac-coupled applications, the user must provide a dc bias externally. Setting the device so that $V_{CM} = AV_{DD}/2$ is recommended for optimum performance, but the device can function over a wider range with reasonable performance, as shown in Figure 27.

An on-board, common-mode voltage reference is included in the design and is available from the VCM pin. The VCM pin must be decoupled to ground by a 0.1 μF capacitor, as described in the Applications Information section.

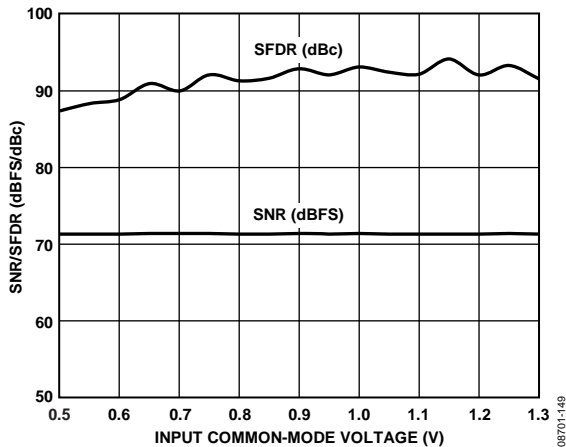

Figure 27. SNR/SFDR vs. Input Common-Mode Voltage, $f_{IN} = 30.5$ MHz, $f_s = 80$ MSPS

Differential Input Configurations

Optimum performance is achieved while driving the AD6659 in a differential input configuration. For baseband applications, the AD8138, ADA4937-2, and ADA4938-2 differential drivers provide excellent performance and a flexible interface to the ADC.

The output common-mode voltage of the ADA4938-2 is easily set with the VCM pin of the AD6659 (see Figure 28), and the driver can be configured in a Sallen-Key filter topology to provide band limiting of the input signal.

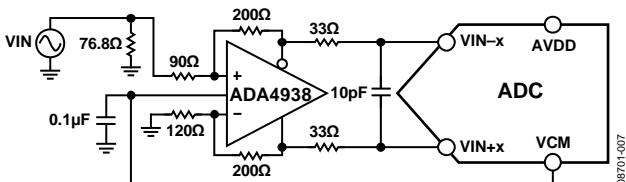

Figure 28. Differential Input Configuration Using the ADA4938

For baseband applications below ~10 MHz where SNR is a key parameter, differential transformer coupling is the recommended input configuration. An example is shown in Figure 29. To bias

the analog input, the VCM voltage can be connected to the center tap of the secondary winding of the transformer.

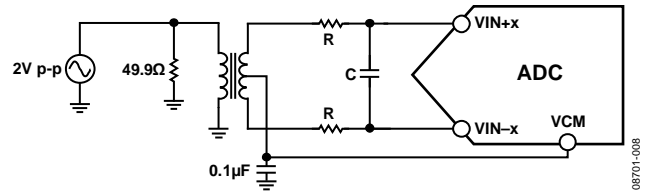

Figure 29. Differential Transformer-Coupled Configuration

The signal characteristics must be considered when selecting a transformer. Most RF transformers saturate at frequencies below a few megahertz (MHz). Excessive signal power can also cause core saturation, which leads to distortion.

At input frequencies in the second Nyquist zone and above, the noise performance of most amplifiers is not adequate to achieve the true SNR performance of the AD6659. For applications above ~10 MHz where SNR is a key parameter, differential double balun coupling is the recommended input configuration (see Figure 31).

An alternative to using a transformer-coupled input at frequencies in the second Nyquist zone is to use the AD8352 differential driver. An example is shown in Figure 32. See the AD8352 data sheet for more information.

In any configuration, the value of Shunt Capacitor C is dependent on the input frequency and source impedance and may need to be reduced or removed. Table 9 displays the suggested values to set the RC network. However, these values are dependent on the input signal and should be used only as a starting guide.

Table 9. Example RC Network

Frequency Range (MHz)	R Series (Ω Each)	C Differential (pF)
0 to 70	33	22
70 to 200	125	Open

Single-Ended Input Configuration

A single-ended input can provide adequate performance in cost-sensitive applications. In this configuration, SFDR and distortion performance degrade due to the large input common-mode swing. If the source impedances on each input are matched, there should be little effect on SNR performance. Figure 30 shows a typical single-ended input configuration.

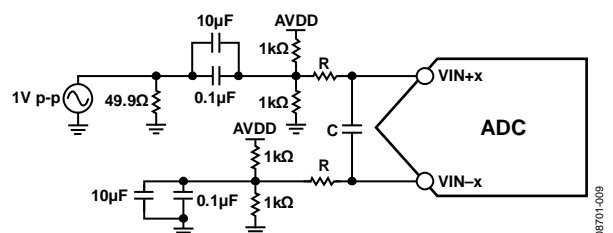

Figure 30. Single-Ended Input Configuration

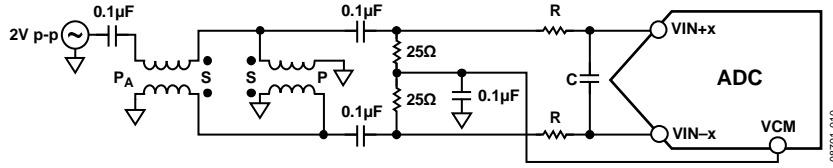

Figure 31. Differential Double Balun Input Configuration

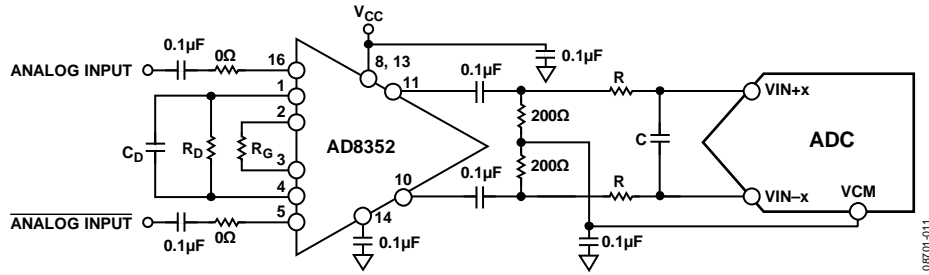

Figure 32. Differential Input Configuration Using the AD8352

VOLTAGE REFERENCE

A stable and accurate 1.0 V voltage reference is built into the AD6659. The VREF can be configured using either the internal 1.0 V reference or an externally applied 1.0 V reference voltage. The various reference modes are summarized in the sections that follow. The Reference Decoupling section describes best practices for PCB layout of the reference.

Internal Reference Connection

A comparator within the AD6659 detects the potential at the SENSE pin and configures the reference in one of two possible modes, which are summarized in Table 10. If SENSE is grounded, the reference amplifier switch is connected to the internal resistor divider (see Figure 33), setting V_{REF} to 1.0 V.

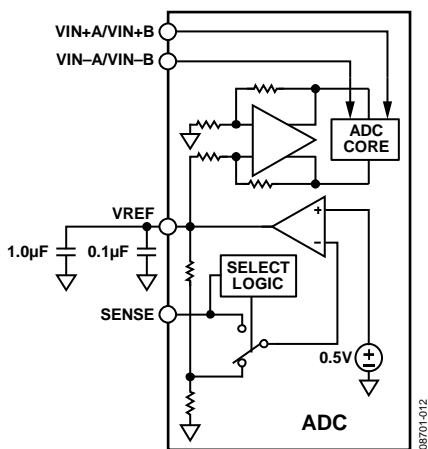

Figure 33. Internal Reference Configuration

If the internal reference of the AD6659 is used to drive multiple converters to improve gain matching, the loading of the reference by the other converters must be considered. Figure 34 shows how the internal reference voltage is affected by loading.

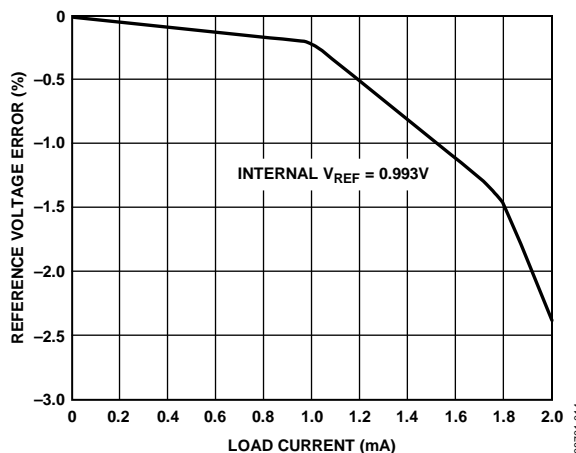

Figure 34. V_{REF} Accuracy vs. Load Current

External Reference Operation

The use of an external reference may be necessary to enhance the gain accuracy of the ADC or improve thermal drift characteristics. Figure 35 shows the typical drift characteristics of the internal reference in 1.0 V mode.

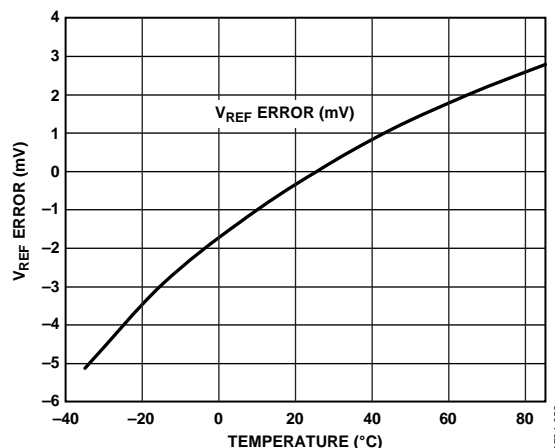

Figure 35. Typical V_{REF} Drift

When the SENSE pin is tied to AVDD, the internal reference is disabled, allowing the use of an external reference. An internal reference buffer loads the external reference with an equivalent 7.5 kΩ load (see Figure 25). The internal buffer generates the positive and negative full-scale references for the ADC core. Therefore, the external reference must be limited to a maximum of 1.0 V.

Table 10. Reference Configuration Summary

Selected Mode	SENSE Voltage (V)	Resulting V_{REF} (V)	Resulting Differential Span (V p-p)
Fixed Internal Reference	AGND to 0.2	1.0 internal	2.0
Fixed External Reference	AVDD	1.0 applied to external VREF pin	2.0

CLOCK INPUT CONSIDERATIONS

For optimum performance, clock the AD6659 sample clock inputs, CLK+ and CLK-, with a differential signal. The signal is typically ac-coupled into the CLK+ and CLK- pins via a transformer or capacitors. These pins are biased internally (see Figure 36) and require no external bias.

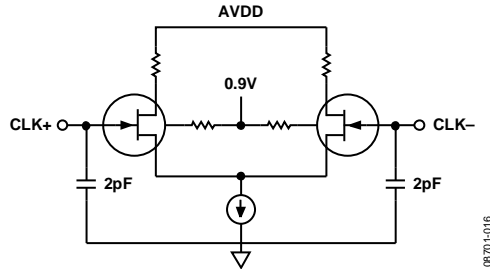

Figure 36. Equivalent Clock Input Circuit

Clock Input Options

The AD6659 has a very flexible clock input structure. The clock input can be a CMOS, LVDS, LVPECL, or sine wave signal. Regardless of the type of signal being used, clock source jitter is of the most concern, as described in the Jitter Considerations section.

Figure 37 and Figure 38 show two preferred methods for clocking the AD6659 (at clock rates up to 480 MHz before the internal CLK divider). A low jitter clock source is converted from a single-ended signal to a differential signal using either an RF transformer or an RF balun.

The RF balun configuration is recommended for clock frequencies between 125 MHz and 480 MHz, and the RF transformer is recommended for clock frequencies from 10 MHz to 200 MHz. The back-to-back Schottky diodes across the transformer/balun secondary limit clock excursions into the AD6659 to approximately 0.8 V p-p differential.

This limit helps prevent the large voltage swings of the clock from feeding through to other portions of the AD6659 while preserving the fast rise and fall times of the signal that are critical to a low jitter performance.

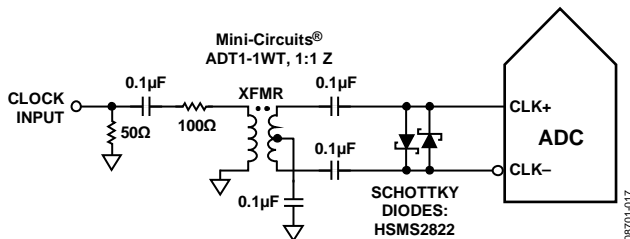

Figure 37. Transformer-Coupled Differential Clock (Up to 200 MHz)

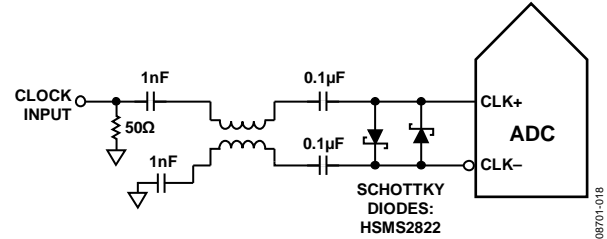

Figure 38. Balun-Coupled Differential Clock (Up to 480 MHz)

If a low jitter clock source is not available, another option is to ac couple a differential PECL signal to the sample clock input pins, as shown in Figure 39. The AD9510/AD9511/AD9512/AD9513/AD9514/AD9515/AD9516/AD9517 clock drivers offer excellent jitter performance.

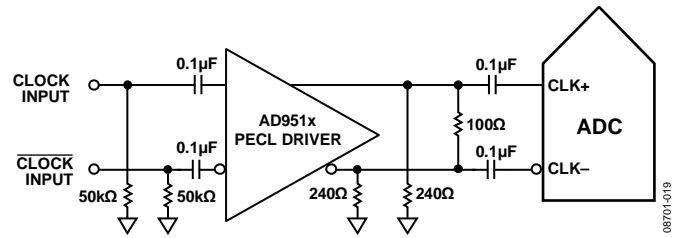

Figure 39. Differential PECL Sample Clock (Up to 480 MHz)

Another option is to ac couple a differential LVDS signal to the sample clock input pins, as shown in Figure 40. The AD9510/AD9511/AD9512/AD9513/AD9514/AD9515/AD9516/AD9517 clock drivers offer excellent jitter performance.

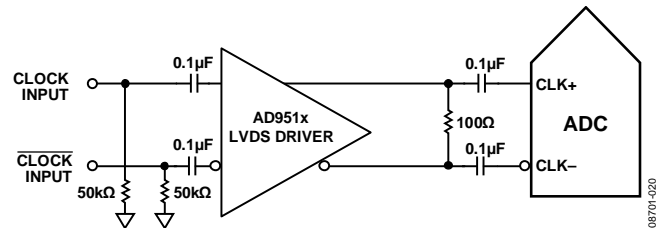
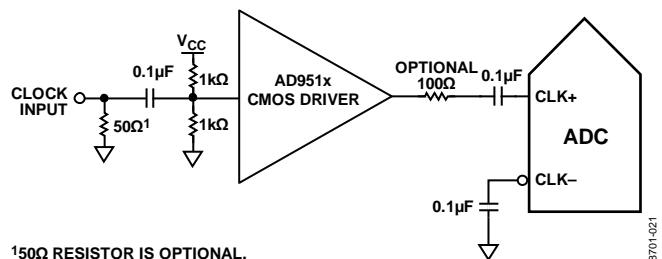

Figure 40. Differential LVDS Sample Clock (Up to 480 MHz)

In some applications, it may be acceptable to drive the sample clock inputs with a single-ended 1.8 V CMOS signal. In such applications, drive the CLK+ pin directly from a CMOS gate and bypass the CLK- pin to ground with a 0.1 μF capacitor (see Figure 41).



150Ω RESISTOR IS OPTIONAL.

Figure 41. Single-Ended 1.8 V CMOS Input Clock (Up to 200 MHz)

Input Clock Divider

The AD6659 contains an input clock divider with the ability to divide the input clock by integer values from 1 to 6. Optimum performance is obtained by enabling the internal DCS when using divide ratios other than 1, 2, or 4.

The AD6659 clock divider can be synchronized using the external SYNC input. Bit 1 and Bit 2 of Register 0x100 allow the clock divider to be resynchronized on every SYNC signal or only on the first SYNC signal after the register is written. A valid SYNC causes the clock divider to reset to its initial state. This synchronization feature allows multiple parts to have their clock dividers aligned to guarantee simultaneous input sampling.

Clock Duty Cycle

Typical high speed ADCs use both clock edges to generate a variety of internal timing signals and, as a result, may be sensitive to clock duty cycle. Commonly, a $\pm 5\%$ tolerance is required on the clock duty cycle to maintain dynamic performance characteristics.

The AD6659 contains a DCS that retimes the nonsampling (falling) edge, providing an internal clock signal with a nominal 50% duty cycle. This allows the user to provide a wide range of clock input duty cycles without affecting the performance of the AD6659. Noise and distortion performance are nearly flat for a wide range of duty cycles with the DCS on, as shown in Figure 42.

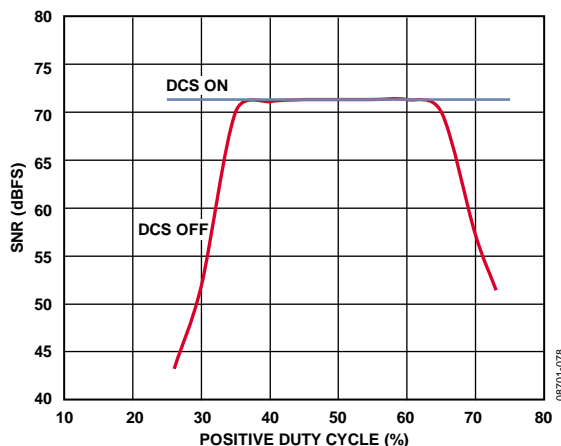

Figure 42. SNR vs. DCS On/Off

Jitter in the rising edge of the input is still of concern and is not easily reduced by the internal stabilization circuit. The duty cycle control loop does not function for clock rates less than 20 MHz nominal. The loop has a time constant associated with it that must be considered in applications in which the clock rate can change dynamically. A wait time of 1.5 μs to 5 μs is required after the dynamic clock frequency increases or decreases before the DCS loop is relocked to the input signal.

Jitter Considerations

High speed, high resolution ADCs are sensitive to the quality of the clock input. The degradation in SNR from the low frequency SNR (SNR_{LF}) at a given input frequency (f_{INPUT}) due to jitter (t_{RMS}) can be calculated by

$$\text{SNR}_{HF} = -10 \log[(2\pi \times f_{\text{INPUT}} \times t_{\text{RMS}})^2 + 10^{(-\text{SNR}_{LF}/10)}]$$

In the previous equation, the rms aperture jitter represents the clock input jitter specification. IF undersampling applications are particularly sensitive to jitter, as illustrated in Figure 43.

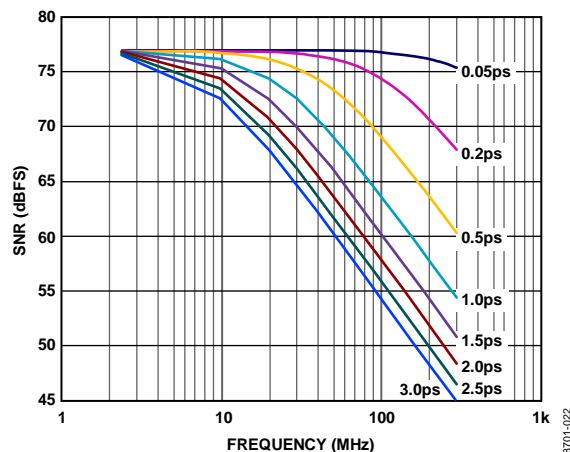

Figure 43. SNR vs. Input Frequency and Jitter

Treat the clock input as an analog signal in cases in which aperture jitter may affect the dynamic range of the AD6659. To avoid modulating the clock signal with digital noise, keep power supplies for clock drivers separate from the ADC output driver supplies. Low jitter, crystal controlled oscillators make the best clock sources. If the clock is generated from another type of source (by gating, dividing, or another method), it should be retimed by the original clock at the last step.

For more information, see the AN-501 Application Note and the AN-756 Application Note, available at www.analog.com.

POWER DISSIPATION AND STANDBY MODE

As shown in Figure 44, the analog core power dissipated by the AD6659 is proportional to its sample rate. The digital power dissipation of the CMOS outputs is determined primarily by the strength of the digital drivers and the load on each output bit.

The maximum DRVDD current (I_{DRVDD}) can be calculated as

$$I_{\text{DRVDD}} = V_{\text{DRVDD}} \times C_{\text{LOAD}} \times f_{\text{CLK}} \times N$$

where N is the number of output bits (26 bits, in the case of the AD6659).

This maximum current occurs when every output bit switches on every clock cycle, that is, a full-scale square wave at the Nyquist frequency of $f_{\text{CLK}}/2$. In practice, the DRVDD current is established by the average number of output bits switching,

AD6659

which is determined by the sample rate and the characteristics of the analog input signal.

Reducing the capacitive load presented to the output drivers can minimize digital power consumption. The data in Figure 44 was taken using the same operating conditions as those used for the Typical Performance Characteristics, with a 5 pF load on each output driver.

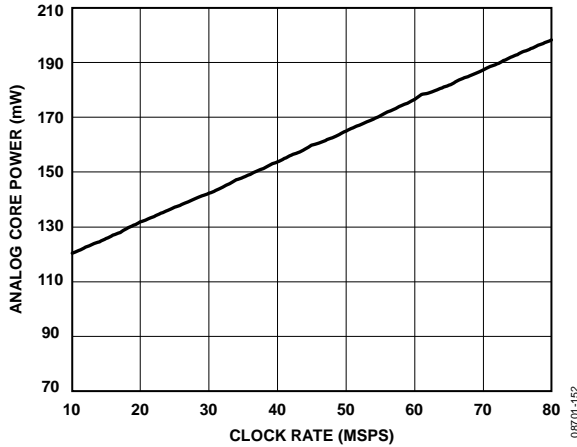

Figure 44. Analog Core Power vs. Clock Rate

The AD6659 is placed in power-down mode either by the SPI port or by asserting the PDWN pin high. In this state, the ADC typically dissipates 1.0 mW. During power-down, the output drivers are placed in a high impedance state. By asserting the PDWN pin low returns the AD6659 to its normal operating mode. Note that PDWN is referenced to the digital output driver supply (DRVDD) and should not exceed that supply voltage.

Low power dissipation in power-down mode is achieved by shutting down the reference, reference buffer, biasing networks, and clock. Internal capacitors are discharged when entering power-down mode and must then be recharged when returning to normal operation. As a result, wake-up time is related to the time spent in power-down mode, and shorter power-down cycles result in proportionally shorter wake-up times.

When using the SPI port interface, the user can place the ADC in power-down mode or standby mode. Standby mode allows the user to keep the internal reference circuitry powered when faster wake-up times are required. See the Memory Map section for more details.

DIGITAL OUTPUTS

The AD6659 output drivers can be configured to interface with 1.8 V to 3.3 V CMOS logic families. Output data can also be multiplexed onto a single output bus to reduce the total number of traces required.

The CMOS output drivers are sized to provide sufficient output current to drive a wide variety of logic families. However, large drive currents tend to cause current glitches on the supplies and may affect converter performance.

Applications that require the ADC to drive large capacitive loads or large fanouts may require external buffers or latches.

The output data format can be selected to be either offset binary or twos complement by setting the SCLK/DFS pin when operating in the external pin mode (see Table 11). Output codings for the respective data formats are shown in Table 12.

As detailed in the AN-877 Application Note, *Interfacing to High Speed ADCs via SPI*, the data format can be selected for offset binary, twos complement, or gray code when using the SPI control.

Table 11. SCLK/DFS Mode Selection (External Pin Mode)

Voltage at Pin	SCLK/DFS	SDIO/DCS
AGND	Offset binary (default)	DCS disabled (default)
DRVDD	Twos complement	DCS enabled

Digital Output Enable Function (OEB)

The AD6659 has a flexible three-state ability for the digital output pins. The three-state mode is enabled using the OEB pin or through the SPI interface. If the OEB pin is low, the output data drivers and DCOs are enabled. If the OEB pin is high, the output data drivers and DCOs are placed in a high impedance state. This OEB function is not intended for rapid access to the data bus. Note that OEB is referenced to the digital output driver supply (DRVDD) and should not exceed that supply voltage.

When using the SPI interface, the data outputs and DCO of each channel can be independently three-stated by using the output disable (OEB) bit (Bit 4) in Register 0x14.

TIMING

The AD6659 provides latched data with a pipeline delay of nine clock cycles. Data outputs are available one propagation delay (t_{PD}) after the rising edge of the clock signal.

Minimize the length of the output data lines and loads placed on them to reduce transients within the AD6659. These transients can degrade converter dynamic performance.

The lowest typical conversion rate of the AD6659 is 3 MSPS. At clock rates below 3 MSPS, dynamic performance can degrade.

Data Clock Output (DCOx)

The AD6659 provides two data clock output (DCOx) signals intended for capturing the data in an external register. The CMOS data outputs are valid on the rising edge of DCOx, unless the DCOx clock polarity was changed via the SPI. See Figure 2 and Figure 3 for graphical timing descriptions.

Table 12. Output Data Format

Input (V)	Condition (V)	Offset Binary Output Mode	Twos Complement Mode	OR
VIN+ – VIN–	$< -V_{REF} - 0.5 \text{ LSB}$	0000 0000 0000	1000 0000 0000	1
VIN+ – VIN–	$= -V_{REF}$	0000 0000 0000	1000 0000 0000	0
VIN+ – VIN–	$= 0$	1000 0000 0000	0000 0000 0000	0
VIN+ – VIN–	$= +V_{REF} - 1.0 \text{ LSB}$	1111 1111 1111	0111 1111 1111	0
VIN+ – VIN–	$> +V_{REF} - 0.5 \text{ LSB}$	1111 1111 1111	0111 1111 1111	1

BUILT-IN SELF-TEST AND OUTPUT TEST

The AD6659 includes a built-in self-test (BIST) feature designed to enable verification of the integrity of each channel as well as to facilitate board level debugging. A BIST feature that verifies the integrity of the digital datapath of the AD6659 is included.

Various output test options are also provided to place predictable values on the outputs of the AD6659.

BIST

The BIST is a thorough test of the digital portion of the selected AD6659 signal path. Perform the BIST test after a reset to ensure that the part is in a known state. During BIST, data from an internal pseudorandom noise (PN) source is driven through the digital datapath of both channels, starting at the ADC block output. At the datapath output, CRC logic calculates a signature from the data. The BIST sequence runs for 512 cycles and then stops.

When completed, the BIST compares the signature results with a predetermined value. If the signatures match, the BIST sets Bit 0 of Register 0x24, signifying that the test passed. If the BIST test failed, Bit 0 of Register 0x24 is cleared. The outputs are connected during this test so that the PN sequence can be observed as it runs. Writing the value of 0x05 to Register 0x0E

runs the BIST. This enables Bit 0 (BIST enable) of Register 0x0E and resets the PN sequence generator, Bit 2 (BIST INIT) of Register 0x0E. At the completion of the BIST, Bit 0 of Register 0x24 automatically clears. The PN sequence can be continued from its last value by writing a 0 in Bit 2 of Register 0x0E. However, if the PN sequence is not reset, the signature calculation does not equal the predetermined value at the end of the test. At that point, the user must rely on verifying the output data.

OUTPUT TEST MODES

The output test options are described in Table 17 at Address 0x0D. When an output test mode is enabled, the analog section of the ADC is disconnected from the digital back end blocks and the test pattern is run through the output formatting block. Some of the test patterns are subject to output formatting, and some of the test patterns are not. The PN generators from the PN sequence tests can be reset by setting Bit 4 or Bit 5 of Register 0x0D.

These tests can be performed with or without an analog signal (if present, the analog signal is ignored), but they do require an encode clock. For more information, see the AN-877 Application Note, *Interfacing to High Speed ADCs via SPI*.

CHANNEL/CHIP SYNCHRONIZATION

The AD6659 has a SYNC input that offers the user flexible synchronization options for synchronizing sample clocks across multiple ADCs. The input clock divider can be enabled to synchronize on a single occurrence of the SYNC signal or on every occurrence. The SYNC input is internally synchronized to the

sample clock; however, to ensure that there is no timing uncertainty exists between multiple parts, the SYNC input signal should be externally synchronized to the input clock signal, meeting the setup and hold times shown in Table 5. Drive the SYNC input using a single-ended CMOS-type signal.

NOISE SHAPING REQUANTIZER

The AD6659 features a noise shaping requantizer (NSR) to allow higher than 12-bit SNR to be maintained in a subset of the Nyquist band. Enabling and disabling the NSR mode is controlled via Bit 0 in the 0x11E SPI register. In NSR mode, the band of interest can be tuned using a low-pass, band-pass, or high-pass filter setting via Bits[2:1] in the 0x11E SPI register.

20% BW NSR MODE (16 MHz BW AT 80 MSPS)

NSR mode offers excellent noise performance over 20% of the ADC sample rate (40% of Nyquist). The fundamental can be tuned using a low-pass, band-pass, or high-pass filter by setting the NSR Mode Bits[2:1] in the 0x11E SPI register.

Figure 45 to Figure 47 shows the typical spectrum that can be expected from the AD6659 with the 20% BW NSR mode enabled for the three different filter settings.

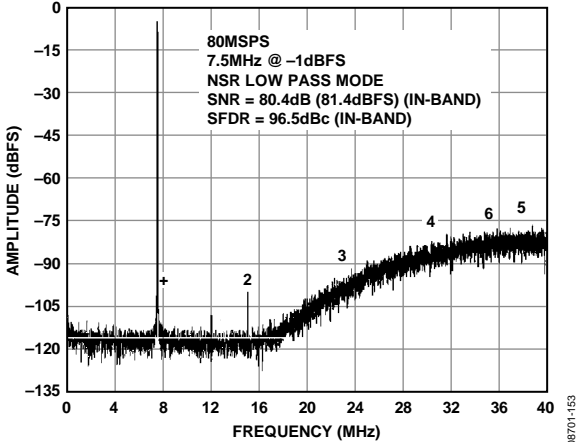

Figure 45. Low Pass NSR Mode: 7.5 MHz AIN @ 80 MSPS (16 MHz BW)

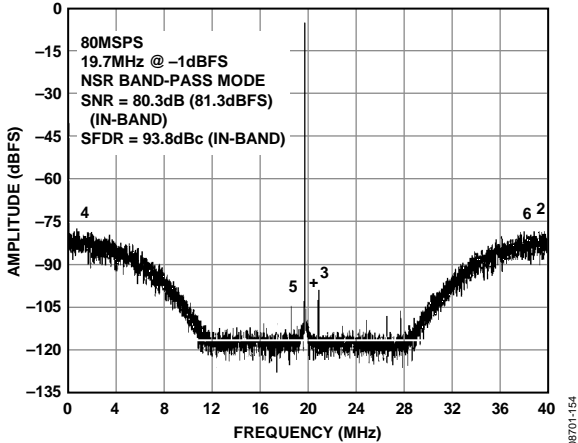

Figure 46. Band-Pass NSR Mode: 19.7 MHz AIN @ 80 MSPS (16 MHz BW)

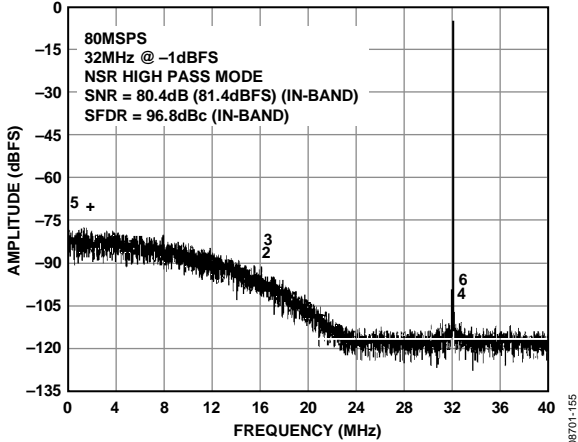

Figure 47. High Pass NSR Mode: 32 MHz AIN @ 80 MSPS (16 MHz BW)

DC AND QUADRATURE ERROR CORRECTION (QEC)

In direct conversion or other quadrature systems, mismatches between the real (I) and imaginary (Q) signal paths cause frequencies in the positive spectrum to image into the negative spectrum and vice versa. From an RF point of view, this is equivalent to information above the LO frequency interfering with information below the LO frequency, and vice versa. These mismatches may occur from gain and/or phase mismatches in the analog quadrature demodulator or in any other mismatches between the I and Q signal chains. In a single-carrier zero-IF system where the carrier has been placed symmetrically around dc, this causes self-distortion of the carrier as the two sidebands fold onto one another and degrade the EVM of the signal.

In a multicarrier communication system, this mismatch can be even more problematic because carriers of widely different power levels can interfere with one another. For example, a large carrier centered at $+f_1$ can have an image appear at $-f_1$ that is much larger than the desired carrier at $-f_1$.

The integrated quadrature error correction (QEC) algorithm of the AD6659 attempts to measure and correct the amplitude and phase imbalances of the I and Q signal paths to achieve higher levels of image suppression than is achievable by analog means alone. These errors can be corrected in an adapted manner, where the I and Q gain and quadrature phase mismatches are constantly estimated and corrected, allowing slow changes in mismatches due to supply and temperature to be constantly tracked.

The quadrature errors are corrected in a frequency independent manner on the AD6659; therefore, systems with significant mismatch in the baseband I and Q signal chains may have reduced image suppression. The AD6659 QEC still corrects the systematic imbalances.

The convergence time of the QEC algorithm is dependent on the statistics of the input signal. For large signals and large imbalance errors, this convergence time is typically less than 2M samples of the AD6659 data rate.

LO Leakage (DC) Correction

In a direct conversion receiver subsystem, LO to RF leakage of the quadrature modulator shows up as dc offsets at baseband. These offsets are added to dc offsets in the baseband signal paths and both contribute to a carrier at dc. In a zero-IF receiver, this dc energy can cause problems because it appears in the band of a desired channel. As part of the AD6659 QEC function, the dc offset is suppressed by applying a low frequency notch filter to form a null around dc. In applications where constant tracking of the dc offsets and quadrature errors is not needed, the algorithms can be independently frozen to save power. When frozen, the image and LO leakage (dc) correction are still performed, but changes are no longer tracked. Bits[5:3] in Register 0x110 disable the respective correction when frozen.

The default configuration of the AD6659 has the QEC and dc correction blocks disabled, and Bits[2:0] in Register 0x110 must be pulled high to enable the correction blocks. The quadrature gain, quadrature phase, and dc correction algorithms can also be disabled independently for system debugging or to save power by pulling Bits[2:0] low in Register 0x110.

When the QEC is enabled and a correction value has been calculated, the value remains active as long as any of the QEC functions (dc, gain, or phase correction) are used.

QEC and DC Correction Range

Table 13 gives the minimum and maximum correction ranges of the QEC algorithms on the AD6659; if the mismatches are greater than these ranges, an imperfect correction results.

Table 13. QEC and DC Correction Range

Parameter	Minimum	Maximum
Gain	-1.1 dB	+1.0 dB
Phase	-1.79°	+1.79°
DC	-6%	+6%

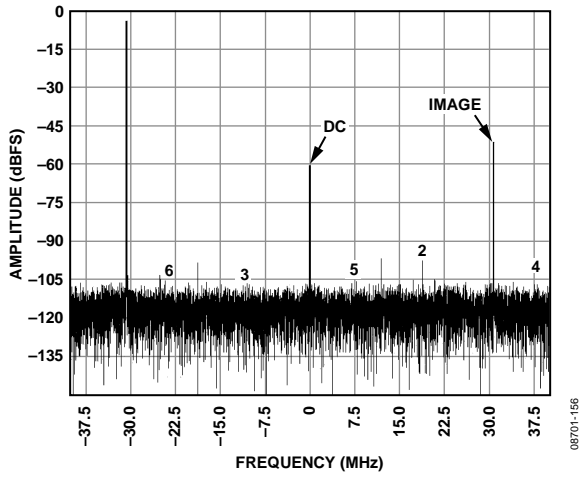

Figure 48. QEC Mode Off

087701-156

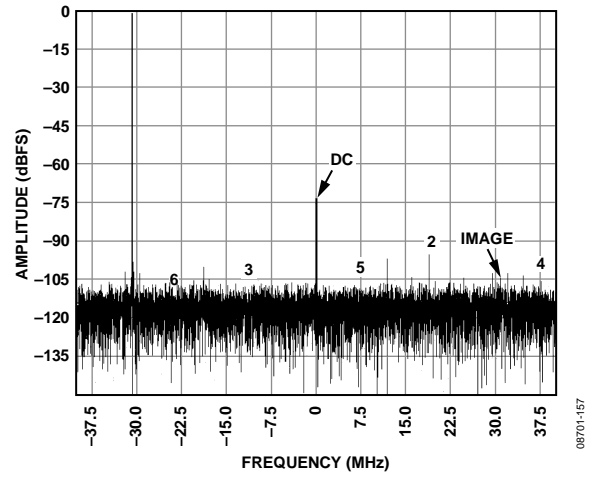

Figure 49. QEC Mode On

087701-157

SERIAL PORT INTERFACE (SPI)

The AD6659 SPI allows the user to configure the converter for specific functions or operations through a structured register space provided inside the ADC. The SPI gives the user added flexibility and customization, depending on the application. Addresses are accessed via the serial port and can be written to or read from the port. Memory is organized into bytes that can be further divided into fields, which are documented in the Memory Map section. For detailed operational information, see the AN-877 Application Note, *Interfacing to High Speed ADCs via SPI*.

CONFIGURATION USING THE SPI

Three pins define the SPI of this ADC: SCLK, SDIO, and CSB (see Table 14). SCLK (a serial clock) is used to synchronize the read and write data presented from and to the ADC. SDIO (serial data input/output) is a dual-purpose pin that allows data to be sent to and read from the internal ADC memory map registers. CSB (chip select bar) is an active low control that enables or disables the read and write cycles.

Table 14. Serial Port Interface Pins

Pin	Description
SCLK	Serial Clock. The serial shift clock input, which is used to synchronize serial interface reads and writes.
SDIO	Serial Data Input/Output. A dual-purpose pin that typically serves as an input or an output, depending on the instruction being sent and the relative position in the timing frame.
CSB	Chip Select Bar. An active low control that gates the read and write cycles.

The falling edge of CSB, in conjunction with the rising edge of SCLK, determines the start of the framing. An example of the serial timing and its definitions can be found in Figure 50 and Table 5.

Other modes involving CSB are available. CSB can be held low indefinitely, which permanently enables the device; this is called streaming. CSB can stall high between bytes to allow for additional external timing. When CSB is tied high, SPI functions are placed in high impedance mode. This mode turns on any SPI pin secondary functions.

During an instruction phase, a 16-bit instruction is transmitted. Data follows the instruction phase, and its length is determined by the W1 and W0 bits, as shown in Figure 50.

All data is composed of 8-bit words. The first bit of the first byte in a multibyte serial data transfer frame indicates whether a read command or a write command is issued. This allows the serial data input/output (SDIO) pin to change direction from an input to an output at the appropriate point in the serial frame.

In addition to word length, the instruction phase determines whether the serial frame is a read or write operation, allowing the serial port to be used both to program the chip and to read the contents of the on-chip memory. If the instruction is a readback operation, performing a readback causes the serial data input/output (SDIO) pin to change direction from an input to an output at the appropriate point in the serial frame.

Data can be sent in MSB-first mode or LSB-first mode. MSB-first mode is the default on power-up and can be changed via the SPI port configuration register. For more information about this and other features, see the AN-877 Application Note, *Interfacing to High Speed ADCs via SPI*.

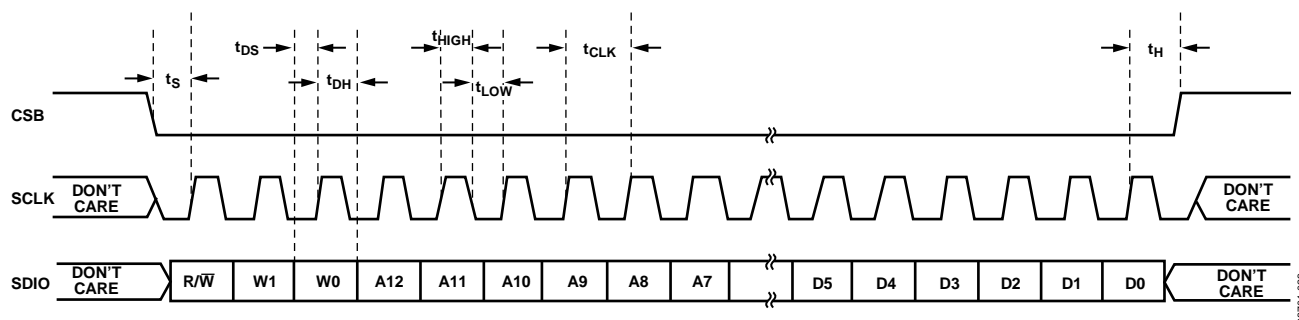

Figure 50. Serial Port Interface Timing Diagram

HARDWARE INTERFACE

The pins described in Table 14 constitute the physical interface between the programming device of the user and the serial port of the AD6659. When using the SPI interface, SCLK and CSB function as inputs. SDIO is bidirectional, functioning as an input during write phases and as an output during readback.

The SPI interface is flexible enough to be controlled by either FPGAs or microcontrollers. One method for SPI configuration is described in detail in the AN-812 Application Note, *Microcontroller-Based Serial Port Interface (SPI) Boot Circuit*.

The SPI port should not be active during periods when the full dynamic performance of the converter is required. Because the SCLK signal, the CSB signal, and the SDIO signal are typically asynchronous to the ADC clock, noise from these signals can degrade converter performance. If the on-board SPI bus is used for other devices, it may be necessary to provide buffers between this bus and the AD6659 to prevent these signals from transitioning at the converter inputs during critical sampling periods.

SDIO/DCS and SCLK/DFS serve a dual function when the SPI interface is not being used. When the pins are strapped to DRVDD or ground during device power-on, they are associated with a specific function. The Digital Outputs section describes the strappable functions supported on the AD6659.

CONFIGURATION WITHOUT THE SPI

In applications that do not interface to the SPI control registers, SDIO/DCS, SCLK/DFS, OEB, and PDWN serve as standalone CMOS-compatible control pins. When the device is powered up, it is assumed that the user intends to use the pins as static control lines for the duty cycle stabilizer, output data format, output enable, and power-down feature control. In this mode, connect the CSB pin to DRVDD, which disables the serial port interface.

Table 15. Mode Selection

Pin	External Voltage	Configuration
SDIO/DCS	DRVDD	Duty cycle stabilizer enabled
	AGND (default)	Duty cycle stabilizer disabled
SCLK/DFS	DRVDD	Twos complement enabled
	AGND (default)	Offset binary enabled
OEB	DRVDD	Outputs in high impedance
	AGND (default)	Outputs enabled
PDWN	DRVDD	Chip in power-down or standby
	AGND (default)	Normal operation

SPI ACCESSIBLE FEATURES

Table 16 provides a brief description of the general features that are accessible via the SPI. These features are described in detail in the AN-877 Application Note, *Interfacing to High Speed ADCs via SPI*. The AD6659 part-specific features are described in detail in Table 17.

Table 16. Features Accessible Using the SPI

Feature	Description
Mode	Allows the user to set either power-down mode or standby mode
Clock Offset	Allows the user to access the DCS via the SPI
Test I/O	Allows the user to digitally adjust the converter offset
Output Mode	Allows the user to set test modes to place known data on output bits
Output Phase	Allows the user to set up outputs
Output Delay	Allows the user to set the output clock polarity
	Allows the user to vary the DCO delay

MEMORY MAP

READING THE MEMORY MAP REGISTER TABLE

Each row in the memory map register table (see Table 17) has eight bit locations. The memory map is roughly divided into four sections: the chip configuration registers (Address 0x00 to Address 0x02); the device index and transfer registers (Address 0x05 and Address 0xFF); the program registers, including setup, control, and test (Address 0x08 to Address 0x2E); and the digital feature control registers (Address 0x100 to Address 0x11E).

Table 17 documents the default hexadecimal value for each hexadecimal address shown. The column with the heading Bit 7 (MSB) is the start of the default hexadecimal value given. For example, Address 0x05, the channel index register, has a hexadecimal default value of 0x03. This means that in Address 0x05 Bits[7:2] = 0, and the remaining Bits[1:0] = 1. This setting is the default channel index setting. The default value results in both ADC channels receiving the next write command. For more information on this function and others, see the AN-877 Application Note, *Interfacing to High Speed ADCs via SPI*. This application note details the functions controlled by Register 0x00 to Register 0xFF. The remaining AD6659 specific registers, Register 0x100 through Register 0x11E, are documented in the Memory Map Register Descriptions section following Table 17.

OPEN LOCATIONS

All address and bit locations excluded in the SPI map are not currently supported for this device. Unused bits of a valid address location should be written with 0s. Writing to these locations is required only when part of an address location is open (for example, Address 0x05). If the entire address location is open, it is omitted from the SPI map (for example, Address 0x13) and should not be written.

DEFAULT VALUES

After the AD6659 is reset, critical registers are loaded with default values. The default values for the registers are given in the memory map register table (see Table 17).

Logic Levels

An explanation of logic level terminology follows:

- “Bit is set” is synonymous with “bit is set to Logic 1” or “writing Logic 1 for the bit.”
- “Bit is cleared” is synonymous with “bit is set to Logic 0” or “writing Logic 0 for the bit.”

Transfer Register Map

Address 0x08 to Address 0x18 are shadowed. Writes to these addresses do not affect part operation until a transfer command is issued by writing 0x01 to Address 0xFF, setting the transfer bit. This allows these registers to be updated internally and simultaneously when the transfer bit is set. The internal update takes place when the transfer bit is set, and then the bit autoclears.

Channel-Specific Registers

Some channel setup functions can be programmed differently for each channel. In these cases, channel address locations are internally duplicated for each channel. These registers and bits are designated in the memory map register table as local. These local registers and bits can be accessed by setting the appropriate Channel A (Bit 0) or Channel B (Bit 1) bit in Register 0x05.

If both bits are set, the subsequent write affects the registers of both channels. In a read cycle, set only Channel A or Channel B to read one of the two registers. If both bits are set during an SPI read cycle, the part returns the value for Channel A. Registers and bits designated as global in the memory map register table (see Table 17) affect the entire part or the channel features for which independent settings are not allowed between channels. The settings in Register 0x05 do not affect the global registers and bits.

AD6659

MEMORY MAP REGISTER TABLE

All address and bit locations excluded from Table 17 are not currently supported for this device.

Table 17.

Addr (Hex)	Register Name	Bit 7 (MSB)	Bit 6	Bit 5	Bit 4	Bit 3	Bit 2	Bit 1	Bit 0 (LSB)	Default Value (Hex)	Comments
Chip Configuration Registers											
0x00	SPI port configuration (global)	0	LSB first	Soft reset	1	1	Soft reset	LSB first	0	0x18	The nibbles are mirrored so that LSB- or MSB-first mode registers correctly, regardless of shift mode
0x01	Chip ID (global)	8-bit Chip ID Bits[7:0] AD6659 = 0x76									Unique chip ID used to differentiate devices; read only
0x02	Chip grade (global)	Open	Speed Grade ID[6:4] 80 MSPS = 011			Open				Unique speed grade ID used to differentiate devices; read only	
Device Index and Transfer Registers											
0x05	Channel index	Open	Open	Open	Open	Open	Open	ADC B default	ADC A default	0x03	Bits are set to determine which device on chip receives the next write command; the default is all devices on chip
0xFF	Transfer	Open	Open	Open	Open	Open	Open	Open	Transfer	0x00	Synchronously transfers data from the master shift register to the slave
Program Registers (May or May Not Be Indexed by Device Index)											
0x08	Modes	External power-down enable (local)	External pin function 0x00 full power-down 0x01 standby (local)		Open	Open		00 = chip run 01 = full power-down 10 = standby 11 = chip wide digital reset (local)		0x80	Determines various generic modes of chip operation
0x09	Clock (global)	Open	Open	Open	Open			Open	Duty cycle stabilize	0x00	Enables or disables theDCS
0x0B	Clock divide (global)	Open					Clock Divider[2:0] Clock divide ratio 000 = divide by 1 001 = divide by 2 010 = divide by 3 011 = divide by 4 100 = divide by 5 101 = divide by 6			0x00	The divide ratio is the value plus 1

Addr (Hex)	Register Name	Bit 7 (MSB)	Bit 6	Bit 5	Bit 4	Bit 3	Bit 2	Bit 1	Bit 0 (LSB)	Default Value (Hex)	Comments
0x0D	Test mode (local)	User test mode (local) 00 = single 01 = alternate 10 = single once 11 = alternate once		Reset PN long gen	Reset PN short gen	Output test mode [3:0] (local) 0000 = off (default) 0001 = midscale short 0010 = positive FS 0011 = negative FS 0100 = alternating checkerboard 0101 = PN 23 sequence 0110 = PN 9 sequence 0111 = 1-/0-word toggle 1000 = user input 1001 = 1-/0-bit toggle 1010 = 1× sync 1011 = one bit high 1100 = mixed bit frequency				0x00	When set, the test data is placed on the output pins in place of normal data
0x0E	BIST enable	Open	Open	Open	Open	Open	BIST INIT	Open	BIST enable	0x00	When Bit 0 is set, the BIST function is initiated
0x10	Offset adjust (local)	8-bit Device Offset Adjustment[7:0] (local) Offset adjust in LSBs from +127 to -128 (twos complement format)								0x00	Device offset trim
0x14	Output mode	00 = 3.3 V CMOS 10 = 1.8 V CMOS		Output mux enable (interleaved)	Output disable (local)	Open	Output invert (local)	00 = offset binary 01 = twos complement 10 = gray code 11 = offset binary (local)		0x00	Configures the outputs and the format of the data
0x15	Output adjust	3.3 V DCO drive strength 00 = 1 stripe (default) 01 = 2 stripes 10 = 3 stripes 11 = 4 stripes		1.8 V DCO drive strength 00 = 1 stripe 01 = 2 stripes 10 = 3 stripes (default) 11 = 4 stripes		3.3 V data drive strength 00 = 1 stripe (default) 01 = 2 stripes 10 = 3 stripes 11 = 4 stripes		1.8 V data drive strength 00 = 1 stripe 01 = 2 stripes 10 = 3 stripes (default) 11 = 4 stripes		0x22	Determines CMOS output drive strength properties
0x16	Output phase	DCO output polarity 0 = normal 1 = inverted (local)	Open	Open	Open	Open	Input Clock Phase Adjust[2:0] (Value is number of input clock cycles of phase delay) 000 = no delay 001 = 1 input clock cycle 010 = 2 input clock cycles 011 = 3 input clock cycles 100 = 4 input clock cycles 101 = 5 input clock cycles 110 = 6 input clock cycles 111 = 7 input clock cycles			0x00	On devices that use global clock divide, this register determines which phase of the divider output is used to supply the output clock; internal latching is unaffected
0x17	Output delay	Enable DCO delay	Open	Enable data delay	Open	Open	DCO/Data Delay[2:0] 000 = 0.56 ns 001 = 1.12 ns 010 = 1.68 ns 011 = 2.24 ns 100 = 2.80 ns 101 = 3.36 ns 110 = 3.92 ns 111 = 4.48 ns			0x00	Sets the fine output delay of the output clock but does not change internal timing
0x19	USER_PATT1_LSB	B7	B6	B5	B4	B3	B2	B1	B0	0x00	User-defined Pattern 1, LSB

AD6659

Addr (Hex)	Register Name	Bit 7 (MSB)	Bit 6	Bit 5	Bit 4	Bit 3	Bit 2	Bit 1	Bit 0 (LSB)	Default Value (Hex)	Comments	
0x1A	USER_PATT1_MSB	B15	B14	B13	B12	B11	B10	B9	B8	0x00	User-defined Pattern 1, MSB	
0x1B	USER_PATT2_LSB	B7	B6	B5	B4	B3	B2	B1	B0	0x00	User-defined Pattern 2, LSB	
0x1C	USER_PATT2_MSB	B15	B14	B13	B12	B11	B10	B9	B8	0x00	User-defined Pattern 2, MSB	
0x24	BIST signature LSB	BIST signature [7:0]								0x00	Least significant byte of BIST signature, read only	
0x2A	Features	Open	Open	Open	Open	Open	Open	Open	OR OE (local)	0x01	Disable the ORx pin for the indexed channel	
0x2E	Output assign	Open	Open	Open	Open	Open	Open	Open	0 = ADC A 1 = ADC B (local)	Ch A = 0x00 Ch B = 0x01	Assigns an ADC to an output channel	
Digital Feature Control Registers												
0x100	Sync control (global)	Open	Open	Open	Open	Open	Clock divider next sync only	Clock divider sync enable	Master sync enable	0x01		
0x101	USR2	Enable OEB Pin 47 (local)	Open	Open	Open	Enable GCLK detect	Run GCLK	Open	Disable SDIO pull-down	0x88	Enables internal oscillator for clock rates < 5 MHz	
0x110	QEC Control 0	Open	Open	Freeze dc	Freeze phase	Freeze gain	DC enable	Phase enable	Gain enable	0x00		
0x111	QEC Control 1	Open	Open	Open	Open	Open	Force dc	Force phase	Force gain	0x00		
0x112	QEC gain bandwidth control	Open			Kexp_gain, Bits[4:0]						0x02	
0x113	QEC phase bandwidth control	Open			Kexp_phase, Bits[4:0]						0x02	
0x114	QEC dc bandwidth control	Open			Kexp_DC, Bits[4:0]						0x02	
0x116	QEC Initial Gain 0	Initial gain, Bits[7:0]									0x00	
0x117	QEC Initial Gain 1	Open	Initial gain, Bits[14:8]								0x00	
0x118	QEC Initial Phase 0	Initial phase, Bits[7:0]									0x00	
0x119	QEC Initial Phase 1	Open			Initial phase, Bits[12:8]						0x00	
0x11A	QEC Initial DC I 0	Initial DC I, Bits[7:0]									0x00	
0x11B	QEC Initial DC I 1	Open	Initial DC I, Bits[13:8]								0x00	
0x11C	QEC Initial DC Q 0	Initial DC Q, Bits[7:0]									0x00	
0x11D	QEC Initial DC Q 1	Open	Initial DC Q, Bits[13:8]								0x00	
0x11E	NSR Control	Open					Noise shaping mode: 00 = low pass 01 = high pass 1x = band-pass			Enable NSR	0x00	

MEMORY MAP REGISTER DESCRIPTIONS

For additional information about functions controlled in Register 0x00 to Register 0xFF, see the AN-877 Application Note, *Interfacing to High Speed ADCs via SPI*.

SynC Control (Register 0x100)

Bits[7:3]—Open

Bit 2—Clock Divider Next Sync Only

If the master sync enable bit (Address 0x100, Bit 0) and the clock divider sync enable bit (Address 0x100, Bit 1) are high, Bit 2 allows the clock divider to sync to the first sync pulse that it receives and to ignore the rest. The clock divider sync enable bit (Address 0x100, Bit 1) resets after it syncs.

Bit 1—Clock Divider Sync Enable

Bit 1 gates the sync pulse to the clock divider. The sync signal is enabled when Bit 1 and Bit 0 are high and the device is operating in continuous sync mode as long as Bit 2 of the sync control register is low.

Bit 0—Master Sync Enable

Bit 0 must be high to enable any of the sync functions.

USR2 (Register 0x101)

Bit 7—Enable OEB Pin 47 (Local)

Normally set high, this bit allows Pin 47 to function as the output enable. If it is set low, it disables Pin 47.

Bits[6:4]—Open

Bit 3—Enable GCLK Detect

Normally set high, this bit enables a circuit that detects encode rates below approximately 5 MSPS. When a low encode rate is detected, an internal oscillator, GCLK, is enabled ensuring the proper operation of several circuits. If set low, the detector is disabled.

Bit 2—Run GCLK

This bit enables the GCLK oscillator. For some applications with encode rates below 10 MSPS, it may be preferable to set this bit high to supersede the GCLK detector (Bit 3).

Bit 1—Open

Bit 0—Disable SDIO Pull-Down

This bit can be set high to disable the internal 30 k Ω pull-down on the SDIO pin, which can be used to limit the loading when many devices are connected to the SPI bus.

QEC Control 0 (Register 0x110)

Bits[7:6]—Open

Bits[5:3]—Freeze DC/Freeze Phase/Freeze Gain

These bits can be used to freeze the corresponding dc, phase, and gain offset corrections of the quadrature error correction (QEC) independently. When asserted high, QEC is applied using frozen values, and the estimation of the quadrature errors is halted.

Bits[2:0]—DC Enable/Phase Enable/Gain Enable

These bits allow the corresponding dc, phase, and gain offset corrections to be enabled independently.

QEC Control 1 (Register 0x111)

Bits[7:3]—Open

Bit 2—Force DC

When set high, this bit forces the initial static correction values from Register 0x11A and Register 0x11B for the I data and Register 0x11C and Register 0x11D for the Q data.

Bit 1—Force Phase

When set high, this bit forces the initial static correction values from Register 0x118 and Register 0x119.

Bit 0—Force Gain

When set high, this bit forces the initial static correction values from Register 0x116 and Register 0x117.

QEC Gain Bandwidth Control (Register 0x112)

Bits[7:5]—Open

Bits[4:0]—Kexp_Gain[4:0]

These bits adjust the time constants of the gain control feedback loop for quadrature error correction.

QEC Phase Bandwidth Control (Register 0x113)

Bits[7:5]—Open

Bits[4:0]—Kexp_Phase[4:0]

These bits adjust the time constants of the phase control feedback loop for quadrature error correction.

QEC DC Bandwidth Control (Register 0x114)

Bits[7:5]—Open

Bits[4:0]—Kexp_DC[4:0]

These bits adjust the time constants of the dc control feedback loop for quadrature error correction.

QEC Initial Gain 0 and QEC Initial Gain 1 (Register 0x116 and Register 0x117)

Bits[14:0]—Initial Gain[14:0]

When the force gain bit (Register 0x111, Bit 0) is set high, these values are used for gain error correction.

QEC Initial Phase 0 and QEC Initial Phase 1 (Register 0x118 and Register 0x119)

Bits[12:0]—Initial Phase[12:0]

When the force phase bit (Register 0x111, Bit 1) is set high, these values are used for phase error correction.

QEC Initial DC I (Register 0x11A and Register 0x11B)

Bits[13:0]—Initial DC I[13:0]

When the force dc bit (Register 0x111, Bit 2) is set high, these values are used for dc error correction.

QEC Initial DC Q (Register 0x11C and Register 0x11D)

Bits[13:0]—Initial DC Q[13:0]

When the force dc bit (Register 0x111, Bit 2) is set high, these values are used for dc error correction.

NSR Control (Register 0x11E)

Bits[7:3]—Open

Bits[2:1]—Noise Shaping Mode

These bits select the mode of the noise shaping requantizer as shown in Table 18.

Bit 0—NSR On and Off Control

When set high, this bit enables the NSR function.

Table 18.

Setting	Mode
00	Low pass mode
01	High pass mode
1x	Band-pass mode

APPLICATIONS INFORMATION

DESIGN GUIDELINES

Before starting design and layout of the AD6659 as a system, it is recommended that the designer become familiar with these guidelines, which discuss the special circuit connections and layout requirements needed for certain pins.

Power and Ground Recommendations

When connecting power to the AD6659, it is strongly recommended that two separate supplies be used. Use one 1.8 V supply for analog (AVDD); use a separate 1.8 V to 3.3 V supply for the digital output supply (DRVDD). If a common 1.8 V AVDD and DRVDD supply must be used, the AVDD and DRVDD domains must be isolated with a ferrite bead or filter choke and separate decoupling capacitors. Several different decoupling capacitors can be used to cover both high and low frequencies. Locate these capacitors close to the point of entry at the PCB level and close to the pins of the part, with minimal trace length.

A single PCB ground plane should be sufficient when using the AD6659. With proper decoupling and smart partitioning of the PCB analog, digital, and clock sections, optimum performance is easily achieved.

Exposed Paddle Thermal Heat Sink Recommendations

The exposed paddle (Pin 0) is the only ground connection for the AD6659; therefore, it must be connected to analog ground (AGND) on the customer's PCB. To achieve the best electrical and thermal performance, mate an exposed (no solder mask) continuous copper plane on the PCB to the AD6659 exposed paddle, Pin 0.

The copper plane should have several vias to achieve the lowest possible resistive thermal path for heat dissipation to flow through the bottom of the PCB. Fill or plug these vias with nonconductive epoxy.

To maximize the coverage and adhesion between the ADC and the PCB, a silkscreen should be overlaid to partition the continuous plane on the PCB into several uniform sections. This provides several tie points between the ADC and the PCB during the reflow process. Using one continuous plane with no partitions guarantees only one tie point between the ADC and the PCB. For detailed information about packaging and PCB layout of chip scale packages, see the AN-772 Application Note, *A Design and Manufacturing Guide for the Lead Frame Chip Scale Package (LFCSP)*, at www.analog.com.

VCM

The VCM pin should be decoupled to ground with a 0.1 μF capacitor, as shown in Figure 29.

RBIAS

The AD6659 requires that a 10 k Ω resistor be placed between the RBIAS pin and ground. This resistor sets the master current reference of the ADC core and should have at least a 1% tolerance.

Reference Decoupling

Externally decouple the VREF pin to ground with a low ESR, 1.0 μF capacitor in parallel with a low ESR, 0.1 μF ceramic capacitor.

SPI Port

The SPI port should not be active during periods when the full dynamic performance of the converter is required. Because the SCLK, CSB, and SDIO signals are typically asynchronous to the ADC clock, noise from these signals can degrade converter performance. If the on-board SPI bus is used for other devices, it may be necessary to provide buffers between this bus and the AD6659 to keep these signals from transitioning at the converter inputs during critical sampling periods.

OUTLINE DIMENSIONS

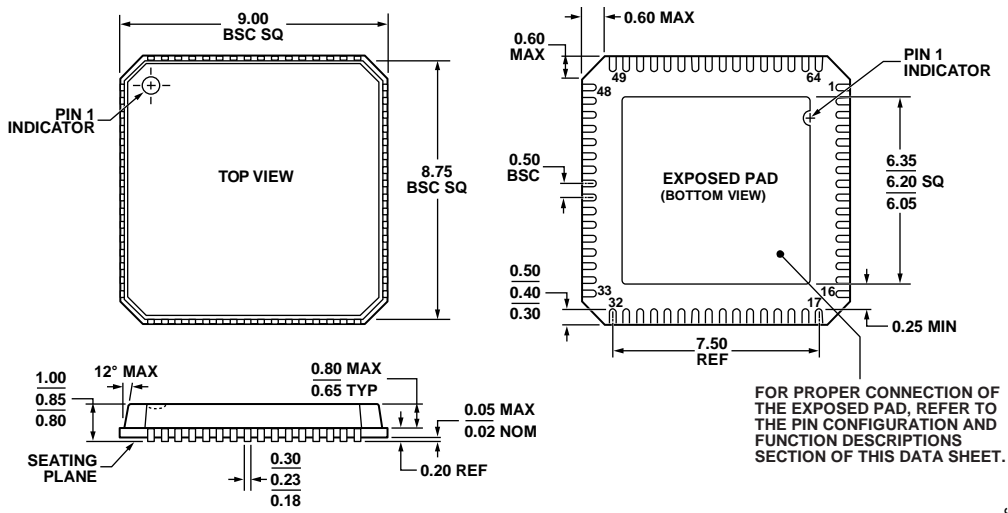

COMPLIANT TO JEDEC STANDARDS MO-220-VMM4-4

Figure 51. 64-Lead Lead Frame Chip Scale Package [LFCSP_VQ]
 9 mm × 9 mm Body, Very Thin Quad (CP-64-4)
 Dimensions shown in millimeters

091707-C

ORDERING GUIDE

Model ¹	Temperature Range	Package Description	Package Option
AD6659BCPZ-80	-40°C to +85°C	64-Lead Lead Frame Chip Scale Package [LFCSP_VQ] ²	CP-64-4
AD6659BCPZRL7-80	-40°C to +85°C	64-Lead Lead Frame Chip Scale Package [LFCSP_VQ] ²	CP-64-4
AD6659-80EBZ		Evaluation Board	

¹ Z = RoHS Compliant Part.

² The exposed paddle (Pin 0) is the only ground connection on the chip and must be connected to the PCB AGND.

NOTES

AD6659

NOTES