



64-pin CK505 w/Fully Integrated Voltage Regulator + Integrated Series Resistor

Recommended Application:

CK505 compliant clock with fully integrated voltage regulator and Internal series resistor on differential outputs

Output Features:

- 2 - CPU differential low power push-pull pairs
- 9 - SRC differential low power push-pull pairs
- 1 - CPU/SRC selectable differential low power push-pull pair
- 1 - SRC/DOT selectable differential low power push-pull pair
- 5 - PCI, 33MHz
- 1 - PCI_F, 33MHz free running
- 1 - USB, 48MHz
- 1 - REF, 14.318MHz

Key Specifications:

- CPU outputs cycle-cycle jitter < 85ps
- SRC output cycle-cycle jitter < 125ps
- PCI outputs cycle-cycle jitter < 250ps
- +/- 100ppm frequency accuracy on CPU & SRC clocks

Features/Benefits:

- Does not require external pass transistor for voltage regulator
- Integrated 30ohm series resistors on differential outputs, $Z_o=50\Omega$
- Supports spread spectrum modulation, default is 0.5% down spread
- Uses external 14.318MHz crystal, external crystal load caps are required for frequency tuning
- Selectable between one SRC differential push-pull pair and two single-ended outputs

Table 1: CPU Frequency Select Table

FS _L C ² B0b7	FS _L B ¹ B0b6	FS _L A ¹ B0b5	CPU MHz	SRC MHz	PCI MHz	REF MHz	USB MHz	DOT MHz
0	0	0	266.66	100.00	33.33	14.318	48.00	96.00
0	0	1	133.33					
0	1	0	200.00					
0	1	1	166.66					
1	0	0	333.33					
1	0	1	100.00					
1	1	0	400.00					
1	1	1	Reserved					

1. FS_LA and FS_LB are low-threshold inputs. Please see $V_{IL,FS}$ and $V_{IH,FS}$ specifications in the Input/Supply/Common Output Parameters Table for correct values. Also refer to the Test Clarification Table.

2. FS_LC is a three-level input. Please see the $V_{IL,FS}$ and $V_{IH,FS}$ specifications in the Input/Supply/Common Output Parameters Table for correct values.

Pin Configuration

Pin	Signal	Pin	Signal
1	PCI0/CR#_A	64	SCLK
2	VDDPC1	63	SDATA
3	PCI1/CR#_B	62	REF0/FSLC/TEST_SEL
4	PCI2/TME	61	VDDREF
5	PCI3	60	X1
6	PCI4/27_Select	59	X2
7	PCI_F5/ITP_EN	58	GNDREF
8	GNDPC1	57	FSLB/TEST_MODE
9	VDD48	56	CK_PWRGD/PD#
10	USB_48MHz/FSLA	55	VDDCPU
11	GND48	54	CPUT0
12	VDD96_IO	53	CPUC0
13	SRCT0/DOTT_96	52	GNDCPU
14	SRCC0/DOTC_96	51	CPUT1_F
15	GND	50	CPUC1_F
16	VDDPLL3	49	VDDCPU_IO
17	27MHz_NonSS/SRCT1/SE1/LCD-SST	48	NC
18	27MHz_SS/SRCC1/SE2/LCD-SSC	47	CPUT2_ITP/SRCT8
19	GND	46	CPUC2_ITP/SRCC8
20	VDDPLL3_IO	45	VDDSRC_IO
21	SRCT2/SATA1	44	SRCT7/CR#_F
22	SRCC2/SATA2	43	SRCC7/CR#_E
23	GNDSRC	42	GNDSRC
24	SRCT3/CR#_C	41	SRCT6
25	SRCC3/CR#_D	40	SRCC6
26	VDDSRC_IO	39	VDDSRC
27	SRCT4	38	PCI_STOP#
28	SRCC4	37	CPU_STOP#
29	GNDSRC	36	VDDSRC_IO
30	SRCT9	35	SRCC10
31	SRCC9	34	SRCT10
32	SRCC11/CR#_G	33	SRCT11/CR#_H

9LPRS355

64-TSSOP
* Internal Pull-Up Resistor
** Internal Pull-Down Resistor

64-pin TSSOP

64-TSSOP

27_Select (power on latch)	0	1
Pin13/14 & Pin17/18	DOT96, LCD_SS Byte1 bit7 = 1.	SRCC0, 27MHz Non SS & SS Byte1 bit7 = 0.

64-MLF

27_Select (power on latch)	0	1
Pin20/21 & Pin24/25	DOT96, LCD_SS Byte1 bit7 = 1	SRCC0, 27MHz Non SS & SS Byte1 bit7= 0.

Preferred drive strengths using CK505 clock sources.

Transmission lines to load do not share series resistors.

Desktop ($Z_o=50\Omega$) and mobile ($Z_o=55\Omega$) have the same drive strength.

D.C. Drive Strength	Number of Loads to Drive	Match Point for N & P Voltage / Current (mA)	Number of Loads Actually Driven. [$Z_o=55\Omega$]		
			1 Load Rs =	2 Loads Rs =	3 Loads Rs =
	1	0.56 / 33 (17 Ω)	33 Ω [39 Ω]	-	-
	2	0.92 / 66 (14 Ω)	39 Ω [43 Ω]	22 Ω [27 Ω]	-
	3	1.15 / 99 (11.6 Ω)	43 Ω [43 Ω]	27 Ω [33 Ω]	15 Ω [22 Ω]



TSSOP Pin Description

PIN #	PIN NAME	TYPE	DESCRIPTION
1	PCI0/CR#_A	I/O	3.3V PCI clock output or Clock Request control A for either SRC0 or SRC2 pair The power-up default is PCI0 output, but this pin may also be used as a Clock Request control of SRC pair 0 or SRC pair 2 via SMBus. Before configuring this pin as a Clock Request Pin, the PCI output must first be disabled in byte 2, bit 0 of SMBus address space . After the PCI output is disabled (high-Z), the pin can then be set to serve as a Clock Request pin for either SRC pair 2 or pair 0 using the CR#_A_EN bit located in byte 5 of SMBUs address space. Byte 5, bit 7 0 = PCI0 enabled (default) 1 = CR#_A enabled. Byte 5, bit 6 controls whether CR#_A controls SRC0 or SRC2 pair Byte 5, bit 6 0 = CR#_A controls SRC0 pair (default), 1 = CR#_A controls SRC2 pair
2	VDDPCI	PWR	Power supply pin for the PCI outputs, 3.3V nominal
3	PCI1/CR#_B	I/O	3.3V PCI clock output/Clock Request control B for either SRC1 or SRC4 pair The power-up default is PCI1 output, but this pin may also be used as a Clock Request control of SRC pair 1 or SRC pair 4 via SMBus. Before configuring this pin as a Clock Request Pin, the PCI output must first be disabled in byte 2, bit 1 of SMBus address space . After the PCI output is disabled (high-Z), the pin can then be set to serve as a Clock Request pin for either SRC pair 1 or pair 4 using the CR#_B_EN bit located in byte 5 of SMBUs address space. Byte 5, bit 5 0 = PCI1 enabled (default) 1 = CR#_B enabled. Byte 5, bit 6 controls whether CR#_B controls SRC1 or SRC4 pair Byte 5, bit 4 0 = CR#_B controls SRC1 pair (default) 1 = CR#_B controls SRC4 pair
4	PCI2/TME	I/O	3.3V PCI clock output / Trusted Mode Enable (TME) Latched Input. This pin is sampled on power-up as follows 0 = Overclocking of CPU and SRC Allowed 1 = Overclocking of CPU and SRC NOT allowed After being sampled on power-up, this pin becomes a 3.3V PCI Output
5	PCI3	OUT	3.3V PCI clock output.
6	PCI4/27_Select	I/O	3.3V PCI clock output / 27MHz mode select for pin17, 18 strap. On powerup, the logic value on this pin determines the power-up default of DOT_96/SRC0 and 27MHz/SRC1 output and the function table for the pin17 and pin18.
7	PCI_F5/ITP_EN	I/O	Free running PCI clock output and ITP/SRC8 enable strap. This output is not affected by the state of the PCI_STOP# pin. On powerup, the state of this pin determines whether pins 38 and 39 are an ITP or SRC pair. 0 =SRC8/SRC8# 1 = ITP/ITP#
8	GNDPCI	PWR	Ground for PCI clocks.
9	VDD48	PWR	Power supply for USB clock, nominal 3.3V.
10	USB_48MHz/FSLA	I/O	Fixed 48MHz USB clock output. 3.3V./ 3.3V tolerant input for CPU frequency selection. Refer to input electrical characteristics for Vil_FS and Vih_FS values.
11	GND48	PWR	Ground pin for the 48MHz outputs.
12	VDD96_IO	PWR	1.05V to 3.3V from external power supply
13	DOTT_96/SRCT0	OUT	True clock of SRC or DOT96. The power-up default function depends on 27_Select,1= SRC0 0=DOT96
14	DOTC_96/SRCC0	OUT	Complement clock of SRC or DOT96. The power-up default function depends on 27_Select,1= SRC0 0=DOT96
15	GND	PWR	Ground pin for the DOT96 clocks.
16	VDD	PWR	Power supply for SRC / SE1 and SE2 clocks, 3.3V nominal.



TSSOP Pin Description (Continued)

PIN #	PIN NAME	TYPE	DESCRIPTION
17	27MHz_NonSS/SRCT1/SE1/LCD-SST	OUT	True clock of differential SRC1 clock pair / 3.3V single-ended output. 27_Select determines the power-up default, 1=27MHz non-spread SE clock, 0 = LCD_SST 100MHz differential clock. See table 2 for more information.
18	27MHz_SS/SRCC1/SE2/LCD-SSC	OUT	Complement clock of differential SRC1 clock pair / 3.3V single-ended output. 27_Select determines the power-up default, 1=27MHz spread SE clock, 0 = LCD_SSC 100MHz differential clock. See table 2 for more information.
19	GND	PWR	Ground pin for SRC / SE1 and SE2 clocks, PLL3.
20	VDDPLL3_IO	PWR	1.05V to 3.3V from external power supply
21	SRCT2/SATAT	OUT	True clock of differential SRC/SATA clock pair.
22	SRCC2/SATAC	OUT	Complement clock of differential SRC/SATA clock pair.
23	GNDSRC	PWR	Ground pin for SRC clocks.
24	SRCT3/CR#_C	I/O	True clock of differential SRC clock pair/ Clock Request control C for either SRC0 or SRC2 pair The power-up default is SRCCLK3 output, but this pin may also be used as a Clock Request control of SRC pair 0 or SRC pair 2 via SMBus. Before configuring this pin as a Clock Request Pin, the SRC3 output must first be disabled in byte 4, bit 7 of SMBus address space . After the SRC3 output is disabled, the pin can then be set to serve as a Clock Request pin for either SRC pair 2 or pair 0 using the CR#_C_EN bit located in byte 5 of SMBUs address space. Byte 5, bit 3 0 = SRC3 enabled (default) 1 = CR#_C enabled. Byte 5, bit 2 controls whether CR#_C controls SRC0 or SRC2 pair Byte 5, bit 2 0 = CR#_C controls SRC0 pair (default), 1 = CR#_C controls SRC2 pair
25	SRCC3/CR#_D	I/O	Complement clock of differential SRC clock pair/ Clock Request control D for either SRC1 or SRC4 pair The power-up default is SRCCLK3 output, but this pin may also be used as a Clock Request control of SRC pair 1 or SRC pair 4 via SMBus. Before configuring this pin as a Clock Request Pin, the SRC3 output must first be disabled in byte 4, bit 7 of SMBus address space . After the SRC3 output is disabled, the pin can then be set to serve as a Clock Request pin for either SRC pair 1 or pair 4 using the CR#_D_EN bit located in byte 5 of SMBUs address space. Byte 5, bit 1 0 = SRC3 enabled (default) 1 = CR#_D enabled. Byte 5, bit 0 controls whether CR#_D controls SRC1 or SRC4 pair Byte 5, bit 0 0 = CR#_D controls SRC1 pair (default), 1 = CR#_D controls SRC4 pair
26	VDDSRC_IO	PWR	1.05V to 3.3V from external power supply
27	SRCT4	I/O	True clock of differential SRC clock pair 4
28	SRCC4	I/O	Complement clock of differential SRC clock pair 4
29	GNDSRC	PWR	Ground pin for SRC clocks.
30	SRCT9	OUT	True clock of differential SRC clock pair.
31	SRCC9	OUT	Complement clock of differential SRC clock pair.
32	SRCC11/CR#_G	I/O	SRC11 complement /Clock Request control for SRC9 pair The power-up default is SRC11#, but this pin may also be used as a Clock Request control of SRC9 via SMBus. Before configuring this pin as a Clock Request Pin, the SRC11 output pair must first be disabled in byte 3, bit 7 of SMBus configuration space After the SRC11 output is disabled (high-Z), the pin can then be set to serve as a Clock Request for SRC9 pair using byte 6, bit 5 of SMBus configuration space Byte 6, bit 5 0 = SRC11# enabled (default) 1 = CR#_G controls SRC9



TSSOP Pin Description (Continued)

PIN #	PIN NAME	TYPE	DESCRIPTION
33	SRCT11/CR#_H	I/O	SRC11 true or Clock Request control H for SRC10 pair The power-up default is SRC11, but this pin may also be used as a Clock Request control of SRC10 via SMBus. Before configuring this pin as a Clock Request Pin, the SRC11 output pair must first be disabled in byte 3, bit 7 of SMBus configuration space After the SRC11 output is disabled (high-Z), the pin can then be set to serve as a Clock Request for SRC10 pair using byte 6, bit 4 of SMBus configuration space Byte 6, bit 4 0 = SRC11 enabled (default) 1 = CR#_H controls SRC10.
34	SRCT10	OUT	True clock of differential SRC clock pair.
35	SRCC10	OUT	Complement clock of differential SRC clock pair.
36	VDDSRC_IO	PWR	1.05V to 3.3V from external power supply
37	CPU_STOP#	IN	Stops all CPU Clocks, except those set to be free running clocks. In AMT mode 3 bits are shifted in from the ICH to set the FSC, FSB, FSA values
38	PCI_STOP#	IN	Stops all PCI Clocks, except those set to be free running clocks. In AMT mode 3 bits are shifted in from the ICH to set the FSC, FSB, FSA values
39	VDDSRC	PWR	VDD pin for SRC Pre-drivers, 3.3V nominal
40	SRCC6	OUT	Complement clock of low power differential SRC clock pair.
41	SRCT6	OUT	True clock of low power differential SRC clock pair.
42	GNDSRC	PWR	Ground for SRC clocks
43	SRCC7/CR#_E	I/O	SRC7 complement or Clock Request control E for SRC6 pair The power-up default is SRC7#, but this pin may also be used as a Clock Request control of SRC6 via SMBus. Before configuring this pin as a Clock Request Pin, the SRC7 output pair must first be disabled in byte 3, bit 3 of SMBus configuration space. After the SRC output is disabled (high-Z), the pin can then be set to serve as a Clock Request for SRC6 pair using byte 6, bit 7 of SMBus configuration space Byte 6, bit 7 0 = SRC7# enabled (default) 1 = CR#_E controls SRC6.
44	SRCT7/CR#_F	I/O	SRC7 true or Clock Request control 8 for SRC8 pair The power-up default is SRC7, but this pin may also be used as a Clock Request control of SRC8 via SMBus. Before configuring this pin as a Clock Request Pin, the SRC7 output pair must first be disabled in byte 3, bit 3 of SMBus configuration space After the SRC output is disabled (high-Z), the pin can then be set to serve as a Clock Request for SRC8 pair using byte 6, bit 6 of SMBus configuration space Byte 6, bit 6 0 = SRC7# enabled (default) 1 = CR#_F controls SRC8.
45	VDDSRC_IO	PWR	1.05V to 3.3V from external power supply
46	CPUC2_ITP/SRCC8	OUT	Complement clock of low power differential CPU2/Complement clock of differential SRC pair. The function of this pin is determined by the latched input value on pin 7, PCIF5/ITP_EN on powerup. The function is as follows: Pin 7 latched input Value 0 = SRC8# 1 = ITP#
47	CPUT2_ITP/SRCT8	OUT	True clock of low power differential CPU2/True clock of differential SRC pair. The function of this pin is determined by the latched input value on pin 7, PCIF5/ITP_EN on powerup. The function is as follows: Pin 7 latched input Value 0 = SRC8 1 = ITP
48	NC	N/A	No Connect



TSSOP Pin Description (Continued)

PIN #	PIN NAME	TYPE	DESCRIPTION
49	VDDCPU_IO	PWR	1.05V to 3.3V from external power supply
50	CPUC1_F	OUT	Complement clock of low power differential CPU clock pair. This clock will be free-running during iAMT.
51	CPUC1_F	OUT	True clock of low power differential CPU clock pair. This clock will be free-running during iAMT.
52	GNDCPU	PWR	Ground Pin for CPU Outputs
53	CPUC0	OUT	Complement clock of low power differential CPU clock pair.
54	CPUC0	OUT	True clock of low power differential CPU clock pair.
55	VDDCPU	PWR	Power Supply 3.3V nominal.
56	CK_PWRGD/PD#	IN	Notifies CK505 to sample latched inputs, or iAMT entry/exit, or PWRDWN# mode
57	FSLB/TEST_MODE	IN	3.3V tolerant input for CPU frequency selection. Refer to input electrical characteristics for V_{il_FS} and V_{ih_FS} values. TEST_MODE is a real time input to select between Hi-Z and REF/N divider mode while in test mode. Refer to Test Clarification Table.
58	GNDREF	PWR	Ground pin for crystal oscillator circuit
59	X2	OUT	Crystal output, nominally 14.318MHz.
60	X1	IN	Crystal input, Nominally 14.318MHz.
61	VDDREF	PWR	Power pin for the REF outputs, 3.3V nominal.
62	REF0/FSLC/TEST_SEL	I/O	3.3V 14.318MHz reference clock/3.3V tolerant low threshold input for CPU frequency selection. Refer to input electrical characteristics for V_{il_FS} and V_{ih_FS} values/ TEST_SEL: 3-level latched input to enable test mode. Refer to Test Clarification Table.
63	SDATA	I/O	Data pin for SMBus circuitry, 5V tolerant.
64	SCLK	IN	Clock pin of SMBus circuitry, 5V tolerant.



Pin Configuration

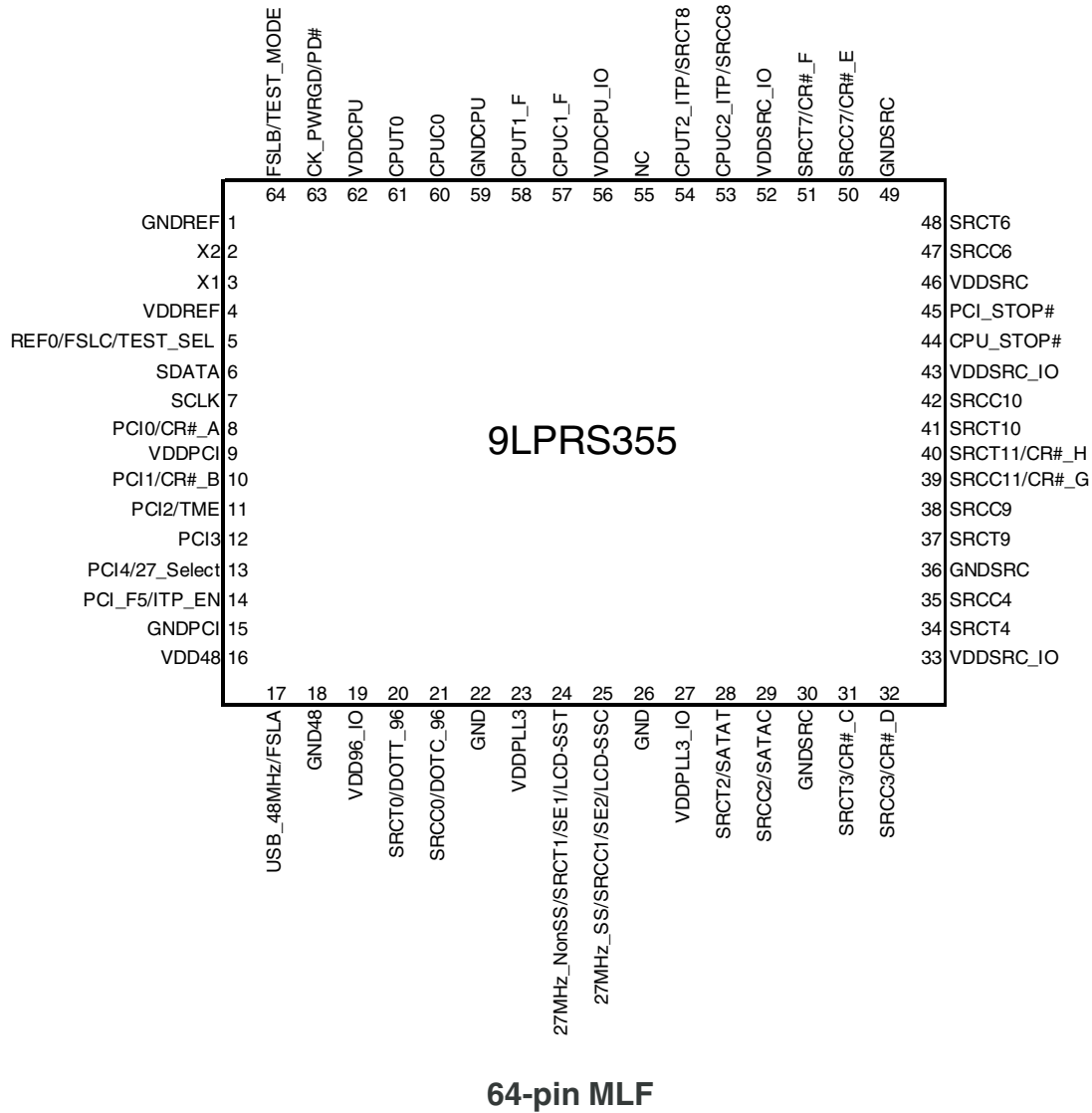



MLF Pin Description

PIN #	PIN NAME	TYPE	DESCRIPTION
1	GNDREF	PWR	Ground pin for crystal oscillator circuit
2	X2	OUT	Crystal output, nominally 14.318MHz.
3	X1	IN	Crystal input, Nominally 14.318MHz.
4	VDDREF	PWR	Power pin for the REF outputs, 3.3V nominal.
5	REF0/FSLC/TEST_SEL	I/O	3.3V 14.318MHz reference clock/3.3V tolerant low threshold input for CPU frequency selection. Refer to input electrical characteristics for V _{IL} _FS and V _{IH} _FS values/ TEST_SEL: 3-level latched input to enable test mode. Refer to Test Clarification Table.
6	SDATA	I/O	Data pin for SMBus circuitry, 5V tolerant.
7	SCLK	IN	Clock pin of SMBus circuitry, 5V tolerant.
8	PCI0/CR#_A	I/O	3.3V PCI clock output or Clock Request control A for either SRC0 or SRC2 pair The power-up default is PCI0 output, but this pin may also be used as a Clock Request control of SRC pair 0 or SRC pair 2 via SMBus. Before configuring this pin as a Clock Request Pin, the PCI output must first be disabled in byte 2, bit 0 of SMBus address space . After the PCI output is disabled (high-Z), the pin can then be set to serve as a Clock Request pin for either SRC pair 2 or pair 0 using the CR#_A_EN bit located in byte 5 of SMBUs address space. Byte 5, bit 7 0 = PCI0 enabled (default) 1= CR#_A enabled. Byte 5, bit 6 controls whether CR#_A controls SRC0 or SRC2 pair Byte 5, bit 6 0 = CR#_A controls SRC0 pair (default), 1= CR#_A controls SRC2 pair
9	VDDPCI	PWR	Power supply pin for the PCI outputs, 3.3V nominal
10	PCI1/CR#_B	I/O	3.3V PCI clock output/Clock Request control B for either SRC1 or SRC4 pair The power-up default is PCI1 output, but this pin may also be used as a Clock Request control of SRC pair 1 or SRC pair 4 via SMBus. Before configuring this pin as a Clock Request Pin, the PCI output must first be disabled in byte 2, bit 1 of SMBus address space . After the PCI output is disabled (high-Z), the pin can then be set to serve as a Clock Request pin for either SRC pair 1 or pair 4 using the CR#_B_EN bit located in byte 5 of SMBUs address space. Byte 5, bit 5 0 = PCI1 enabled (default) 1= CR#_B enabled. Byte 5, bit 6 controls whether CR#_B controls SRC1 or SRC4 pair Byte 5, bit 4 0 = CR#_B controls SRC1 pair (default) 1= CR#_B controls SRC4 pair
11	PCI2/TME	I/O	3.3V PCI clock output / Trusted Mode Enable (TME) Latched Input. This pin is sampled on power-up as follows 0 = Overclocking of CPU and SRC Allowed 1 = Overclocking of CPU and SRC <u>NOT</u> allowed After being sampled on power-up, this pin becomes a 3.3V PCI Output
12	PCI3	OUT	3.3V PCI clock output.
13	PCI4/27_Select	I/O	3.3V PCI clock output / 27MH mode select for pin24, 25 strap. On powerup, the logic value on this pin determines the power-up default of DOT_96/SRC0 and 27MHz/SRC1 output and the function table for the pin24 and pin25.
14	PCI_F5/ITP_EN	I/O	Free running PCI clock output and ITP/SRC8 enable strap. This output is not affected by the state of the PCI_STOP# pin. On powerup, the state of this pin determines whether pins 38 and 39 are an ITP or SRC pair. 0 =SRC8/SRC8# 1 = ITP/ITP#
15	GNDPCI	PWR	Ground for PCI clocks.
16	VDD48	PWR	Power supply for USB clock, nominal 3.3V.



MLF Pin Description (Continued)

PIN #	PIN NAME	TYPE	DESCRIPTION
17	USB_48MHz/FSLA	I/O	Fixed 48MHz USB clock output. 3.3V/ 3.3V tolerant input for CPU frequency selection. Refer to input electrical characteristics for V_{il_FS} and V_{ih_FS} values.
18	GND48	PWR	Ground pin for the 48MHz outputs.
19	VDD96_IO	PWR	1.05V to 3.3V from external power supply
20	SRCT0/DOTT_96	OUT	True clock of SRC or DOT96. The power-up default function depends on 27_Select, 1= SRC0 0=DOT96
21	SRCC0/DOTC_96	OUT	Complement clock of SRC or DOT96. The power-up default function depends on 27_Select, 1= SRC0 0=DOT96
22	GND	PWR	Ground pin for the DOT96 clocks.
23	VDDPLL3	PWR	Power supply for SRC / SE1 and SE2 clocks, 3.3V nominal.
24	27MHz_NonSS/SRCT1/SE1/LCD-SST	OUT	True clock of differential SRC1 clock pair / 3.3V single-ended output. 27_Select determines the power-up default, 1=27MHz non-spread SE clock, 0 = LCD_SST 100MHz differential clock. See table 2 for more information.
25	27MHz_SS/SRCC1/SE2/LCD-SSC	OUT	Complement clock of differential SRC1 clock pair / 3.3V single-ended output. 27_Select determines the power-up default, 1=27MHz spread SE clock, 0 = LCD_SSC 100MHz differential clock. See table 2 for more information.
26	GND	PWR	Ground pin for SRC / SE1 and SE2 clocks, PLL3.
27	VDDPLL3_IO	PWR	1.05V to 3.3V from external power supply
28	SRCT2/SATAT	OUT	True clock of differential SRC/SATA clock pair.
29	SRCC2/SATAC	OUT	Complement clock of differential SRC/SATA clock pair.
30	GNDSRC	PWR	Ground pin for SRC clocks.
31	SRCT3/CR#_C	I/O	<p>True clock of differential SRC clock pair/ Clock Request control C for either SRC0 or SRC2 pair</p> <p>The power-up default is SRCCLK3 output, but this pin may also be used as a Clock Request control of SRC pair 0 or SRC pair 2 via SMBus. Before configuring this pin as a Clock Request Pin, the SRC3 output must first be disabled in byte 4, bit 7 of SMBus address space . After the SRC3 output is disabled, the pin can then be set to serve as a Clock Request pin for either SRC pair 2 or pair 0 using the CR#_C_EN bit located in byte 5 of SMBus address space.</p> <p>Byte 5, bit 3 0 = SRC3 enabled (default) 1= CR#_C enabled. Byte 5, bit 2 controls whether CR#_C controls SRC0 or SRC2 pair</p> <p>Byte 5, bit 2 0 = CR#_C controls SRC0 pair (default), 1= CR#_C controls SRC2 pair</p>
32	SRCC3/CR#_D	I/O	<p>Complementary clock of differential SRC clock pair/ Clock Request control D for either SRC1 or SRC4 pair</p> <p>The power-up default is SRCCLK3 output, but this pin may also be used as a Clock Request control of SRC pair 1 or SRC pair 4 via SMBus. Before configuring this pin as a Clock Request Pin, the SRC3 output must first be disabled in byte 4, bit 7 of SMBus address space . After the SRC3 output is disabled, the pin can then be set to serve as a Clock Request pin for either SRC pair 1 or pair 4 using the CR#_D_EN bit located in byte 5 of SMBus address space.</p> <p>Byte 5, bit 1 0 = SRC3 enabled (default) 1= CR#_D enabled. Byte 5, bit 0 controls whether CR#_D controls SRC1 or SRC4 pair</p> <p>Byte 5, bit 0 0 = CR#_D controls SRC1 pair (default), 1= CR#_D controls SRC4 pair</p>



MLF Pin Description (Continued)

PIN #	PIN NAME	TYPE	DESCRIPTION
33	VDDSRC_IO	PWR	1.05V to 3.3V from external power supply
34	SRCT4	I/O	True clock of differential SRC clock pair 4
35	SRCC4	I/O	Complement clock of differential SRC clock pair 4
36	GNDSRC	PWR	Ground pin for SRC clocks.
37	SRCT9	OUT	True clock of differential SRC clock pair.
38	SRCC9	OUT	Complement clock of differential SRC clock pair.
39	SRCC11/CR#_G	I/O	<p>SRC11 complement /Clock Request control for SRC9 pair The power-up default is SRC11#, but this pin may also be used as a Clock Request control of SRC9 via SMBus. Before configuring this pin as a Clock Request Pin, the SRC11 output pair must first be disabled in byte 3, bit 7 of SMBus configuration space After the SRC11 output is disabled (high-Z), the pin can then be set to serve as a Clock Request for SRC9 pair using byte 6, bit 5 of SMBus configuration space</p> <p>Byte 6, bit 5 0 = SRC11# enabled (default) 1 = CR#_G controls SRC9</p>
40	SRCT11/CR#_H	I/O	<p>SRC11 true or Clock Request control H for SRC10 pair The power-up default is SRC11, but this pin may also be used as a Clock Request control of SRC10 via SMBus. Before configuring this pin as a Clock Request Pin, the SRC11 output pair must first be disabled in byte 3, bit 7 of SMBus configuration space After the SRC11 output is disabled (high-Z), the pin can then be set to serve as a Clock Request for SRC10 pair using byte 6, bit 4 of SMBus configuration space</p> <p>Byte 6, bit 4 0 = SRC11 enabled (default) 1 = CR#_H controls SRC10.</p>
41	SRCT10	OUT	True clock of differential SRC clock pair.
42	SRCC10	OUT	Complement clock of differential SRC clock pair.
43	VDDSRC_IO	PWR	1.05V to 3.3V from external power supply
44	CPU_STOP#	IN	Stops all CPU Clocks, except those set to be free running clocks. In AMT mode 3 bits are shifted in from the ICH to set the FSC, FSB, FSA values
45	PCI_STOP#	IN	Stops all PCI Clocks, except those set to be free running clocks. In AMT mode 3 bits are shifted in from the ICH to set the FSC, FSB, FSA values
46	VDDSRC	PWR	VDD pin for SRC Pre-drivers, 3.3V nominal
47	SRCC6	OUT	Complement clock of low power differential SRC clock pair.
48	SRCT6	OUT	True clock of low power differential SRC clock pair.



MLF Pin Description (Continued)

PIN #	PIN NAME	TYPE	DESCRIPTION
49	GNDSRC	PWR	Ground for SRC clocks
50	SRCC7/CR#_E	I/O	<p>SRC7 complement or Clock Request control E for SRC6 pair The power-up default is SRC7#, but this pin may also be used as a Clock Request control of SRC6 via SMBus. Before configuring this pin as a Clock Request Pin, the SRC7 output pair must first be disabled in byte 3, bit 3 of SMBus configuration space. After the SRC output is disabled (high-Z), the pin can then be set to serve as a Clock Request for SRC6 pair using byte 6, bit 7 of SMBus configuration space</p> <p>Byte 6, bit 7 0 = SRC7# enabled (default) 1 = CR#_E controls SRC6.</p>
51	SRCT7/CR#_F	I/O	<p>SRC7 true or Clock Request control 8 for SRC8 pair The power-up default is SRC7, but this pin may also be used as a Clock Request control of SRC8 via SMBus. Before configuring this pin as a Clock Request Pin, the SRC7 output pair must first be disabled in byte 3, bit 3 of SMBus configuration space After the SRC output is disabled (high-Z), the pin can then be set to serve as a Clock Request for SRC8 pair using byte 6, bit 6 of SMBus configuration space</p> <p>Byte 6, bit 6 0 = SRC7# enabled (default) 1 = CR#_F controls SRC8.</p>
52	VDDSRC_IO	PWR	1.05V to 3.3V from external power supply
53	CPUC2_ITP/SRCC8	OUT	<p>Complement clock of low power differential CPU2/Complement clock of differential SRC pair. The function of this pin is determined by the latched input value on pin 7, PCIF5/ITP_EN on powerup. The function is as follows: Pin 7 latched input Value 0 = SRC8# 1 = ITP#</p>
54	CPUT2_ITP/SRCT8	OUT	<p>True clock of low power differential CPU2/True clock of differential SRC pair. The function of this pin is determined by the latched input value on pin 7, PCIF5/ITP_EN on powerup. The function is as follows: Pin 7 latched input Value 0 = SRC8 1 = ITP</p>
55	NC	N/A	No Connect
56	VDDCPU_IO	PWR	1.05V to 3.3V from external power supply
57	CPUC1_F	OUT	Complement clock of low power differential CPU clock pair. This clock will be free-running during iAMT.
58	CPUT1_F	OUT	True clock of low power differential CPU clock pair. This clock will be free-running during iAMT.
59	GNDCPU	PWR	Ground Pin for CPU Outputs
60	CPUC0	OUT	Complement clock of low power differential CPU clock pair.
61	CPUT0	OUT	True clock of low power differential CPU clock pair.
62	VDDCPU	PWR	Power Supply 3.3V nominal.
63	CK_PWRGD/PD#	IN	Notifies CK505 to sample latched inputs, or iAMT entry/exit, or PWRDWN# mode
64	FSLB/TEST_MODE	IN	3.3V tolerant input for CPU frequency selection. Refer to input electrical characteristics for V_{iL_FS} and V_{iH_FS} values. TEST_MODE is a real time input to select between Hi-Z and REF/N divider mode while in test mode. Refer to Test Clarification Table.



General Description

ICS9LPRS355 follows Intel CK505 Yellow Cover specification. This clock synthesizer provides a single chip solution for next generation P4 Intel processors and Intel chipsets. ICS9LPRS355 is driven with a 14.318MHz crystal. It also provides a tight ppm accuracy output for Serial ATA and PCI-Express support.

Block Diagram

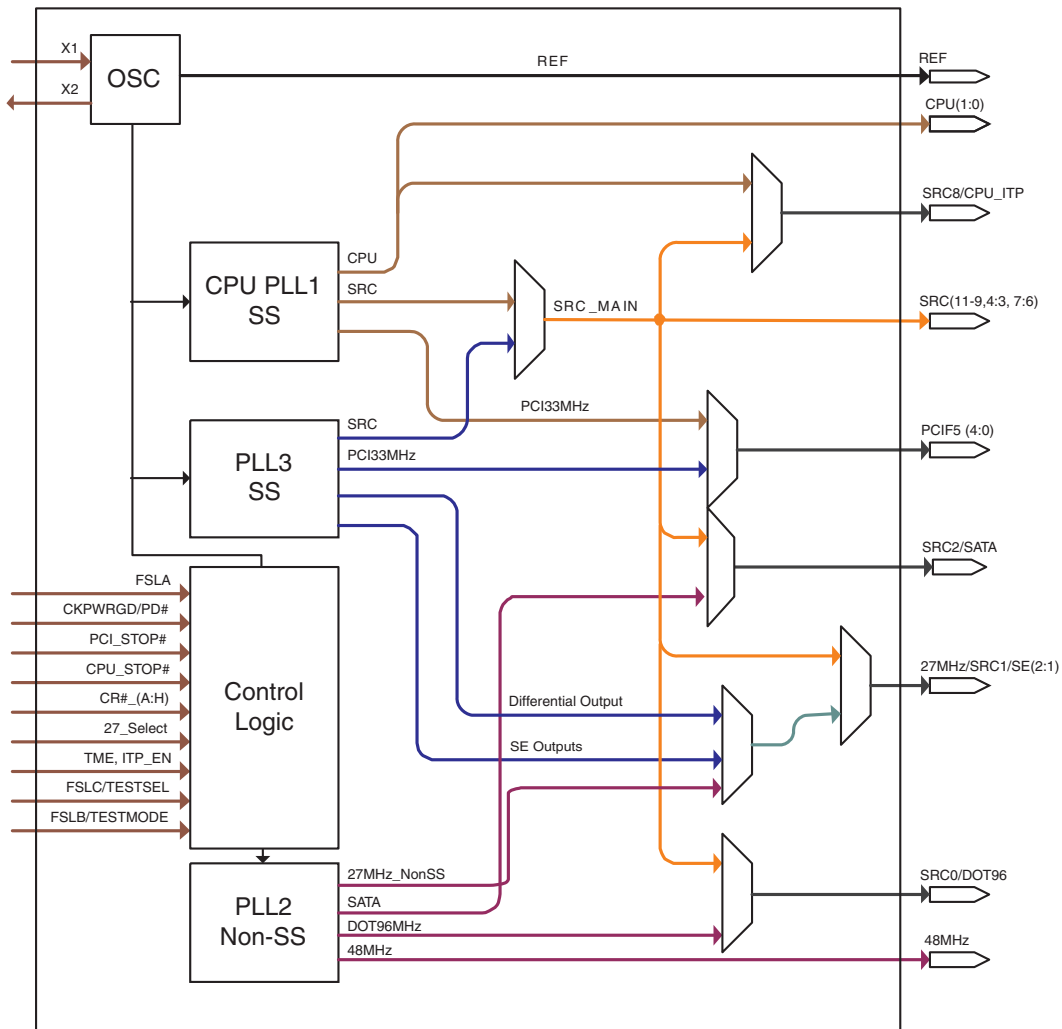

Power Groups

Pin Number		Description	
VDD	GND		
49	52	CPUCLK	Low power outputs
55	52	Master Clock, Analog	
26, 36, 45	23, 29, 42	SRCCLK	Low power outputs
39	23, 29, 42		PLL 1
20	19	PLL3/SE	Low power outputs
16	19		PLL 3
12	11	DOT 96Mhz	Low power outputs
9	11	USB 48	
61	58	Xtal, REF	
2	8	PCICLK	



Absolute Maximum Ratings

PARAMETER	SYMBOL	CONDITIONS	MIN	MAX	UNITS	Notes
Maximum Supply Voltage	VDDxxx	Supply Voltage		4.6	V	1,7
Maximum Supply Voltage	VDDxxx_IO	Low-Voltage Differential I/O Supply		3.8	V	1,7
Maximum Input Voltage	V _{IH}	3.3V LVCMOS Inputs		4.6	V	1,7,8
Minimum Input Voltage	V _{IL}	Any Input	GND - 0.5		V	1,7
Storage Temperature	T _s	-	-65	150	°C	1,7
Case Temperature	T _{case}			115	°C	1
Input ESD protection	ESD prot	Human Body Model	2000		V	1,7

Electrical Characteristics - Input/Supply/Common Output Parameters

PARAMETER	SYMBOL	CONDITIONS	MIN	TYPICAL	MAX	UNITS	Notes
Ambient Operating Temp	T _{ambient}	-	0		70	°C	1
Supply Voltage	VDDxxx	Supply Voltage	3.135		3.465	V	1
Supply Voltage	VDDxxx_IO	Low-Voltage Differential I/O Supply	1		3.465	V	1
Input High Voltage	V _{IHSE}	Single-ended inputs	2		V _{DD} + 0.3	V	1
Input Low Voltage	V _{ILSE}	Single-ended inputs	V _{SS} - 0.3		0.8	V	1
Input Leakage Current	I _{IN}	V _{IN} = V _{DD} , V _{IN} = GND	-5		5	uA	1
Input Leakage Current	I _{INRES}	Inputs with pull or pull down resistors V _{IN} = V _{DD} , V _{IN} = GND	-200		200	uA	1
Output High Voltage	V _{OHSE}	Single-ended outputs, I _{OH} = -1mA	2.4			V	1
Output Low Voltage	V _{OLSE}	Single-ended outputs, I _{OL} = 1 mA			0.4	V	1
Output High Voltage	V _{OHDIF}	Differential Outputs, I _{OH} = TBD mA	0.7		0.9	V	1
Output Low Voltage	V _{OLDIF}	Differential Outputs, I _{OL} = TBD mA			0.4	V	1
Low Threshold Input-High Voltage (Test Mode)	V _{IH_FS_TEST}	3.3 V +/-5%	2		V _{DD} + 0.3	V	1
Low Threshold Input-High Voltage	V _{IH_FS}	3.3 V +/-5%	0.7		1.5	V	1
Low Threshold Input-Low Voltage	V _{IL_FS}	3.3 V +/-5%	V _{SS} - 0.3		0.35	V	1
Operating Supply Current	I _{DD_DEFAULT}	3.3V supply, PLL3 off		95	250	mA	1
	I _{DD_PLL3DIF}	3.3V supply, PLL3 Differential Out		106	250	mA	1
	I _{DD_PLL3SE}	3.3V supply, PLL3 Single-ended Out		101	250	mA	1
	I _{DD_IO}	VDD_IO supply, Differential IO current, all outputs enabled	25	32	80	mA	1
Power Down Current	I _{DD_PD3.3}	3.3V supply, Power Down Mode		26	30	mA	1
	I _{DD_PDIO}	VDD_IO IO supply, Power Down Mode		0.23	0.5	mA	1
iAMT Mode Current	I _{DD_iAMT3.3}	3.3V supply, iAMT Mode		47	80	mA	1
	I _{DD_iAMT0.8}	VDD_IO IO supply, iAMTMode		5	10	mA	1
Input Frequency	F _i	V _{DD} = 3.3 V			14.318	MHz	2
Pin Inductance	L _{pin}				7	nH	1
Input Capacitance	C _{IN}	Logic Inputs	1.5		5	pF	1
	C _{OUT}	Output pin capacitance			6	pF	1
	C _{INX}	X1 & X2 pins			5	pF	1
Spread Spectrum Modulation Frequency	f _{SSMOD}	Triangular Modulation	30		33	kHz	1



AC Electrical Characteristics - Input/Common Parameters

PARAMETER	SYMBOL	CONDITIONS	MIN	MAX	UNITS	Notes
Clk Stabilization	T_{STAB}	From VDD Power-Up or de-assertion of PD# to 1st clock		1.8	ms	1
Tdrive_SRC	T_{DRSRC}	SRC output enable after PCI_STOP# de-assertion		15	ns	1
Tdrive_PD#	T_{DRPD}	Differential output enable after PD# de-assertion		300	us	1
Tdrive_CPU	T_{DRSRC}	CPU output enable after CPU_STOP# de-assertion		10	ns	1
Tfall_PD#	T_{FALL}	Fall/rise time of PD#, PCI_STOP# and CPU_STOP# inputs		5	ns	1
Trise_PD#	T_{RISE}			5	ns	1

AC Electrical Characteristics - Low Power Differential Outputs

PARAMETER	SYMBOL	CONDITIONS	MIN	MAX	UNITS	NOTES
Rising Edge Slew Rate	t_{SLR}	Differential Measurement	2.5	8	V/ns	1,2
Falling Edge Slew Rate	t_{FLR}	Differential Measurement	2.5	8	V/ns	1,2
Slew Rate Variation	t_{SLVAR}	Single-ended Measurement		20	%	1
Maximum Output Voltage	V_{HIGH}	Includes overshoot		1150	mV	1
Minimum Output Voltage	V_{LOW}	Includes undershoot	-300		mV	1
Differential Voltage Swing	V_{SWING}	Differential Measurement	300		mV	1
Crossing Point Voltage	V_{XABS}	Single-ended Measurement	300	550	mV	1,3,4
Crossing Point Variation	$V_{XABSVAR}$	Single-ended Measurement		140	mV	1,3,5
Duty Cycle	D_{CYC}	Differential Measurement	45	55	%	1
CPU Jitter - Cycle to Cycle	$CPUJ_{C2C}$	Differential Measurement		85	ps	1
SRC Jitter - Cycle to Cycle	$SRCJ_{C2C}$	Differential Measurement		125	ps	1
DOT Jitter - Cycle to Cycle	$DOTJ_{C2C}$	Differential Measurement		250	ps	1
CPU[1:0] Skew	CPU_{SKEW10}	Differential Measurement		100	ps	1
CPU[2:ITP:0] Skew	CPU_{SKEW20}	Differential Measurement		150	ps	1
SRC[10:0] Skew	SRC_{SKEW}	Differential Measurement		TBD	ps	1

Electrical Characteristics - 27MHz_Spread / 27MHz_NonSpread

PARAMETER	SYMBOL	CONDITIONS	MIN	TYP	MAX	UNITS	Notes
Long Accuracy	ppm	see Tperiod min-max values	-50		50	ppm	1,2
			-15		15		1,2,3
Clock period	T_{period}	27.000MHz output nominal	37.0365		37.0376		
Output High Voltage	V_{OH}	$I_{OH} = -1 \text{ mA}$	2.4			V	1
Output Low Voltage	V_{OL}	$I_{OL} = 1 \text{ mA}$			0.55	V	1
Output High Current	I_{OH}	$V_{OH} @ \text{MIN} = 1.0 \text{ V}$	-29			mA	1
		$V_{OH} @ \text{MAX} = 3.135 \text{ V}$			-23	mA	1
Output Low Current	I_{OL}	$V_{OL} @ \text{MIN} = 1.95 \text{ V}$	29			mA	1
		$V_{OL} @ \text{MAX} = 0.4 \text{ V}$			27	mA	1
Edge Rate	t_{slewff}	Rising/Falling edge rate	1		4	V/ns	1
Rise Time	t_{r1}	$V_{OL} = 0.4 \text{ V}, V_{OH} = 2.4 \text{ V}$	0.5		2	ns	1
Fall Time	t_{f1}	$V_{OH} = 2.4 \text{ V}, V_{OL} = 0.4 \text{ V}$	0.5		2	ns	1
Duty Cycle	d_{T1}	$V_T = 1.5 \text{ V}$	45		55	%	1
Jitter	t_{Tj}	Long Term (10us)			800	ps	1
	t_{jpk-pk}		-200		200	ps	1
	$t_{cyc-cyc}$	$V_T = 1.5 \text{ V}$			200	ps	1

*TA = 0 - 70°C; Supply Voltage VDD = 3.3 V +/-5%, CL = 20 pF with Rs = 7Ω

¹Guaranteed by design and characterization, not 100% tested in production.

²All Long Term Accuracy and Clock Period specifications are guaranteed assuming that REFOUT is at 14.31818MHz

³At nominal voltage and temperature



Electrical Characteristics - PCICLK/PCICLK_F

PARAMETER	SYMBOL	CONDITIONS	MIN	MAX	UNITS	NOTES
Long Accuracy	ppm	see Tperiod min-max values	-300	300	ppm	1,6
Clock period	T _{period}	33.33MHz output nominal	29.99100	30.00900	ns	6
		33.33MHz output spread		30.15980	ns	6
Absolute min/max period	T _{abs}	33.33MHz output nominal/spread	29.49100	30.65980	ns	6
Output High Voltage	V _{OH}	I _{OH} = -1 mA	2.4		V	1
Output Low Voltage	V _{OL}	I _{OL} = 1 mA		0.4	V	1
Output High Current	I _{OH}	V _{OH} @ MIN = 1.0 V	-33		mA	1
		V _{OH} @ MAX = 3.135 V		-33	mA	1
Output Low Current	I _{OL}	V _{OL} @ MIN = 1.95 V	30		mA	1
		V _{OL} @ MAX = 0.4 V		38	mA	1
Rising Edge Slew Rate	t _{SLR}	Measured from 0.8 to 2.0 V	1	4	V/ns	1
Falling Edge Slew Rate	t _{FLR}	Measured from 2.0 to 0.8 V	1	4	V/ns	1
Duty Cycle	d _{tt}	V _T = 1.5 V	45	55	%	1
Skew	t _{skew}	V _T = 1.5 V		250	ps	1
Intentional PCI-PCI delay	t _{delay}	V _T = 1.5 V	200 nominal		ps	1,9
Jitter, Cycle to cycle	t _{jcy-cyc}	V _T = 1.5 V		500	ps	1

Intentional PCI Clock to Clock Delay

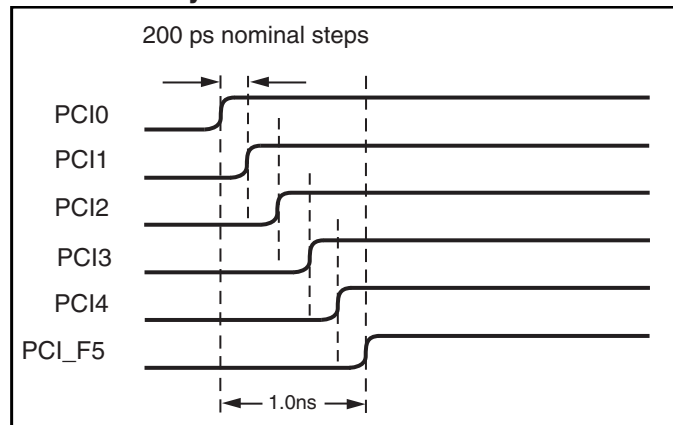

Electrical Characteristics - USB48MHz

PARAMETER	SYMBOL	CONDITIONS	MIN	MAX	UNITS	NOTES
Long Accuracy	ppm	see Tperiod min-max values	-100	100	ppm	1,2
Clock period	T _{period}	48.00MHz output nominal	20.83125	20.83542	ns	2
Absolute min/max period	T _{abs}	48.00MHz output nominal	20.48130	21.18540	ns	2
Output High Voltage	V _{OH}	I _{OH} = -1 mA	2.4		V	1
Output Low Voltage	V _{OL}	I _{OL} = 1 mA		0.4	V	1
Output High Current	I _{OH}	V _{OH} @ MIN = 1.0 V	-29		mA	1
		V _{OH} @ MAX = 3.135 V		-23	mA	1
Output Low Current	I _{OL}	V _{OL} @ MIN = 1.95 V	29		mA	1
		V _{OL} @ MAX = 0.4 V		27	mA	1
Rising Edge Slew Rate	t _{SLR}	Measured from 0.8 to 2.0 V	1	2	V/ns	1
Falling Edge Slew Rate	t _{FLR}	Measured from 2.0 to 0.8 V	1	2	V/ns	1
Duty Cycle	d _{tt}	V _T = 1.5 V	45	55	%	1
Jitter, Cycle to cycle	t _{jcy-cyc}	V _T = 1.5 V		350	ps	1



Electrical Characteristics - SMBus Interface

PARAMETER	SYMBOL	CONDITIONS	MIN	MAX	UNITS	Notes
SMBus Voltage	V_{DD}		2.7	5.5	V	1
Low-level Output Voltage	V_{OLSMB}	@ I_{PULLUP}		0.4	V	1
Current sinking at $V_{OLSMB} = 0.4$ V	I_{PULLUP}	SMB Data Pin	4		mA	1
SCLK/SDATA Clock/Data Rise Time	T_{R12C}	(Max $V_{IL} - 0.15$) to (Min $V_{IH} + 0.15$)		1000	ns	1
SCLK/SDATA Clock/Data Fall Time	T_{F12C}	(Min $V_{IH} + 0.15$) to (Max $V_{IL} - 0.15$)		300	ns	1
Maximum SMBus Operating Frequency	F_{SMBUS}	Block Mode		100	kHz	1

Electrical Characteristics - REF-14.318MHz

PARAMETER	SYMBOL	CONDITIONS	MIN	MAX	UNITS	Notes
Long Accuracy	ppm	see Tperiod min-max values	-300	300	ppm	1,2
Clock period	T_{period}	14.318MHz output nominal	69.8203	69.8622	ns	2
Absolute min/max period	T_{abs}	14.318MHz output nominal	69.8203	70.86224	ns	2
Output High Voltage	V_{OH}	$I_{OH} = -1$ mA	2.4		V	1
Output Low Voltage	V_{OL}	$I_{OL} = 1$ mA		0.4	V	1
Output High Current	I_{OH}	V_{OH} @ MIN = 1.0 V, V_{OH} @ MAX = 3.135 V	-33	-33	mA	1
Output Low Current	I_{OL}	V_{OL} @ MIN = 1.95 V, V_{OL} @ MAX = 0.4 V	30	38	mA	1
Rising Edge Slew Rate	t_{SLR}	Measured from 0.8 to 2.0 V	1	4	V/ns	1
Falling Edge Slew Rate	t_{FLR}	Measured from 2.0 to 0.8 V	1	4	V/ns	1
Duty Cycle	d_{11}	$V_T = 1.5$ V	45	55	%	1
Jitter	$t_{jyc-cyc}$	$V_T = 1.5$ V		1000	ps	1

Notes on Electrical Characteristics:

- ¹ Guaranteed by design and characterization, not 100% tested in production.
- ² Slew rate measured through V_{swing} centered around differential zero
- ³ V_{xabs} is defined as the voltage where $CLK = CLK\#$
- ⁴ Only applies to the differential rising edge (CLK rising and CLK# falling)
- ⁵ Defined as the total variation of all crossing voltages of CLK rising and CLK# falling. Matching applies to rising edge rate of CLK and falling edge of CLK#. It is measured using a +/-75mV window centered on the average cross point where CLK meets CLK#.
- ⁶ All Long Term Accuracy and Clock Period specifications are guaranteed assuming that REFOUT is at 14.31818MHz
- ⁷ Operation under these conditions is neither implied, nor guaranteed.
- ⁸ Maximum input voltage is not to exceed maximum VDD
- ⁹ See PCI Clock-to-Clock Delay Figure



Table 1: CPU Frequency Select Table

FS _L C ² B0b7	FS _L B ¹ B0b6	FS _L A ¹ B0b5	CPU MHz	SRC MHz	PCI MHz	REF MHz	USB MHz	DOT MHz
0	0	0	266.66	100.00	33.33	14.318	48.00	96.00
0	0	1	133.33					
0	1	0	200.00					
0	1	1	166.66					
1	0	0	333.33					
1	0	1	100.00					
1	1	0	400.00					
1	1	1	Reserved					

1. FS_LA and FS_LB are low-threshold inputs. Please see V_{IL_FS} and V_{IH_FS} specifications in the Input/Supply/Common Output Parameters Table for correct values.

Also refer to the Test Clarification Table.

2. FS_LC is a three-level input. Please see the V_{IL_FS} and V_{IH_FS} specifications in the Input/Supply/Common Output Parameters Table for correct values.

Table 2: PLL3 Quick Configuration

27 Select	B1b4	B1b3	B1b2	B1b1	Pin17 (TSSOP) / Pin24 (MLF)	Pin18 (TSSOP) / Pin25 (MLF)	Spread	Comment
					MHz	MHz	%	
0	0	0	0	0	PLL 3 disabled			
0	0	0	0	1	100.00	100.00	0.5% Down Spread	SRCCLK1 from SRC_MAIN
0	0	0	1	0	100.00	100.00	0.5% Down Spread	Only SRCCLK1 from PLL3
0	0	0	1	1	100.00	100.00	1% Down Spread	Only SRCCLK1 from PLL3
0	0	1	0	0	100.00	100.00	1.5% Down Spread	Only SRCCLK1 from PLL3
0	0	1	0	1	100.00	100.00	2% Down Spread	Only SRCCLK1 from PLL3
0	0	1	1	0	100.00	100.00	2.5% Down Spread	Only SRCCLK1 from PLL3
0	0	1	1	1	N/A	N/A	N/A	N/A
0	1	0	0	0	24.576	24.576	None	24.576Mhz on SE1 and SE2
0	1	0	0	1	24.576	98.304	None	24.576Mhz on SE1, 98.304Mhz on SE2
0	1	0	1	0	98.304	98.304	None	98.304Mhz on SE1 and SE2
0	1	0	1	1	27.000	27.000	None	27Mhz on SE1 and SE2
0	1	1	0	0	25.000	25.000	None	25Mhz on SE1 and SE2
0	1	1	0	1	N/A	N/A	N/A	N/A
0	1	1	1	0	N/A	N/A	N/A	N/A
0	1	1	1	1	N/A	N/A	N/A	N/A
1	0	0	0	0	N/A	N/A	N/A	
1	0	0	0	1	N/A	N/A	N/A	
1	0	0	1	0	27MHz_nonSS	27MHz_SS	0.5% Down Spread	
1	0	0	1	1	27MHz_nonSS	27MHz_SS	1% Down Spread	
1	0	1	0	0	27MHz_nonSS	27MHz_SS	1.5% Down Spread	
1	0	1	0	1	27MHz_nonSS	27MHz_SS	2% Down Spread	
1	0	1	1	0	27MHz_nonSS	27MHz_SS	0.75% Down Spread	
1	0	1	1	1	27MHz_nonSS	27MHz_SS	1.25% Down Spread	
1	1	0	0	0	27MHz_nonSS	27MHz_SS	1.75% Down Spread	
1	1	0	0	1	27MHz_nonSS	27MHz_SS	0.5% Center Spread	
1	1	0	1	0	27MHz_nonSS	27MHz_SS	0.75% Center Spread	
1	1	0	1	1	N/A	N/A		
1	1	1	0	0	N/A	N/A		
1	1	1	0	1	N/A	N/A		
1	1	1	1	0	N/A	N/A		
1	1	1	1	1	N/A	N/A		



Table 3: IO_Vout select table

B9b2	B9b1	B9b0	IO_Vout
0	0	0	0.3V
0	0	1	0.4V
0	1	0	0.5V
0	1	1	0.6V
1	0	0	0.7V
1	0	1	0.8V
1	1	0	0.9V
1	1	1	1.0V

CPU Power Management Table

PD#	CPU_STOP#	PCI_STOP#	CR#	SMBus Register OE	CPU1	CPU1#	CPU(0,2)	CPU(0,2)#
1	1	1	X	Enable	Running	Running	Running	Running
0	X	X	X	Enable	Low/20K	Low	Low/20K	Low
1	0	X	X	Enable	High	Low	High	Low
1	X	X	X	Disable	Low/20K	Low	Low/20K	Low
M1					Running	Running	Low/20K	Low

SRC, LCD, DOT Power Management Table

PD#	CPU_STOP#	PCI_STOP#	CR#	SMBus Register OE	SRC/LCD	SRC#/LCD#	SRC/LCD	SRC#/LCD#	DOT	DOT#
					Free-Run		PCI Stoppable/CR Selected			
1	X	1	0	Enable	Running	Running	Running	Running	Running	Running
0	X	X	X	Enable	Low/20K	Low	Low/20K	Low	Low/20K	Low
1	X	0	X	Enable	Running	Running	High	Low	Running	Running
1	X	X	1	Enable	Running	Running	Low/20K	Low	Running	Running
1	X	X	X	Disable	Low/20K	Low	Low/20K	Low	Low/20K	Low
M1					Low/20K	Low	Low/20K	Low	Low/20K	Low

Singled-ended Power Management Table

PD#	CPU_STOP#	PCI_STOP#	CR#	SMBus Register OE	PCIF/PCI	PCIF/PCI	USB	REF
					Free-run	Stoppable		
1	X	1	X	Enable	Running	Running	Running	Running
0	X	X	X	Enable	Low	Low	Low	Low
1	X	0	X	Enable	Running	Low	Running	Running
1	X	X	X	Disable	Low	Low	Low	Low
M1					Low	Low	Low	Low



General SMBus serial interface information for the ICS9LPRS355

How to Write:

- Controller (host) sends a start bit.
- Controller (host) sends the write address D2_(H)
- ICS clock will **acknowledge**
- Controller (host) sends the beginning byte location = N
- ICS clock will **acknowledge**
- Controller (host) sends the data byte count = X
- ICS clock will **acknowledge**
- Controller (host) starts sending **Byte N through Byte N + X - 1**
- ICS clock will **acknowledge** each byte **one at a time**
- Controller (host) sends a Stop bit

How to Read:

- Controller (host) will send start bit.
- Controller (host) sends the write address D2_(H)
- ICS clock will **acknowledge**
- Controller (host) sends the beginning byte location = N
- ICS clock will **acknowledge**
- Controller (host) will send a separate start bit.
- Controller (host) sends the read address D3_(H)
- ICS clock will **acknowledge**
- ICS clock will send the data byte count = X
- ICS clock sends **Byte N + X - 1**
- ICS clock sends **Byte 0 through byte X (if X_(H) was written to byte 8).**
- Controller (host) will need to acknowledge each byte
- Controller (host) will send a not acknowledge bit
- Controller (host) will send a stop bit

Index Block Write Operation		
Controller (Host)		ICS (Slave/Receiver)
T	starT bit	
Slave Address D2 _(H)		
WR	WRite	
		ACK
Beginning Byte = N		
		ACK
Data Byte Count = X		
		ACK
Beginning Byte N		X Byte
○		
○		
○		
Byte N + X - 1		
		ACK
P	stoP bit	

Index Block Read Operation		
Controller (Host)		ICS (Slave/Receiver)
T	starT bit	
Slave Address D2 _(H)		
WR	WRite	
		ACK
Beginning Byte = N		
		ACK
RT	Repeat starT	
Slave Address D3 _(H)		
RD	ReaD	
		ACK
		Data Byte Count = X
ACK		X Byte
ACK		
○		
○		
○		
		Byte N + X - 1
N	Not acknowledge	
P	stoP bit	



Byte 0 FS Readback and PLL Selection Register

Bit	Pin	Name	Description	Type	0	1	Default
7	-	FSLC	CPU Freq. Sel. Bit (Most Significant)	R	See Table 1 : CPU Frequency Select Table		Latch
6	-	FSLB	CPU Freq. Sel. Bit	R			Latch
5	-	FSLA	CPU Freq. Sel. Bit (Least Significant)	R			Latch
4	-	iAMT_EN	Set via SMBus or dynamically by CK505 if detects dynamic M1	RW (Sticky Bit)	Legacy Mode	iAMT Enabled	0
3		Reserved	Reserved	RW			0
2	-	SRC_Main_SEL	Select source for SRC Main	RW	SRC Main = PLL1	SRC Main = PLL3	0
1	-	SATA_SEL	Select source for SATA clock	RW	SATA = SRC_Main	SATA = PLL2	0
0	-	PD_Restore	If config saved, on deassert return to last known state else clear all config as if cold power on and go to latches open state	RW	Configuration Not Saved	Configuration Saved	1

Byte 1 DOT96 Select and PLL3 Quick Config Register

Bit	Pin	Name	Description	Type	0	1	Default
7	13/14	SRC0_SEL	Select SRC0 or DOT96	R	SRC0	DOT96	Note 1
6	-	PLL1_SSC_SEL	Select 0.5% down or center SSC	RW	Down spread	Center spread	0
5		Reserved		RW			0
4	17/18	PLL3_CF3	PLL3 Quick Config Bit 3	RW	See Table 2: pin17, 18 Configuration Only applies if Byte 0, bit 2 = 0.		0
3		PLL3_CF2	PLL3 Quick Config Bit 2	RW			0
2		PLL3_CF1	PLL3 Quick Config Bit 1	RW			1
1		PLL3_CF0	PLL3 Quick Config Bit 0	RW			0
0		PCI_SEL	PCI_SEL	RW	PCI from PLL1	PCI from PLL3	1

Note 1 : When 27_Select pin = 0, B1b7 PWD = 1, , when 27_Select pin = 1, PWD = 0

Byte 2 Output Enable Register

Bit	Pin	Name	Description	Type	0	1	Default
7		REF_OE	Output enable for REF, if disabled output is tri-stated	RW	Output Disabled	Output Enabled	1
6		USB_OE	Output enable for USB	RW	Output Disabled	Output Enabled	1
5		PCI5_OE	Output enable for PCI5	RW	Output Disabled	Output Enabled	1
4		PCI4_OE	Output enable for PCI4	RW	Output Disabled	Output Enabled	1
3		PCI3_OE	Output enable for PCI3	RW	Output Disabled	Output Enabled	1
2		PCI2_OE	Output enable for PCI2	RW	Output Disabled	Output Enabled	1
1		PCI1_OE	Output enable for PCI1	RW	Output Disabled	Output Enabled	1
0		PCI0_OE	Output enable for PCI0	RW	Output Disabled	Output Enabled	1

Byte 3 Output Enable Register

Bit	Pin	Name	Description	Type	0	1	Default
7		SRC11_OE	Output enable for SRC11	RW	Output Disabled	Output Enabled	1
6		SRC10_OE	Output enable for SRC10	RW	Output Disabled	Output Enabled	1
5		SRC9_OE	Output enable for SRC9	RW	Output Disabled	Output Enabled	1
4		SRC8/ITP_OE	Output enable for SRC8 or ITP	RW	Output Disabled	Output Enabled	1
3		SRC7_OE	Output enable for SRC7	RW	Output Disabled	Output Enabled	1
2		SRC6_OE	Output enable for SRC6	RW	Output Disabled	Output Enabled	1
1		Reserved	Reserved	RW	Output Disabled	Output Enabled	1
0		SRC4_OE	Output enable for SRC4	RW	Output Disabled	Output Enabled	1

Byte 4 Output Enable and Spread Spectrum Disable Register

Bit	Pin	Name	Description	Type	0	1	Default
7		SRC3_OE	Output enable for SRC3	RW	Output Disabled	Output Enabled	1
6		SATA/SRC2_OE	Output enable for SATA/SRC2	RW	Output Disabled	Output Enabled	1
5		SRC1_OE	Output enable for SRC1	RW	Output Disabled	Output Enabled	1
4		SRC0/DOT96_OE	Output enable for SRC0/DOT96	RW	Output Disabled	Output Enabled	1
3		CPU1_OE	Output enable for CPU1	RW	Output Disabled	Output Enabled	1
2		CPU0_OE	Output enable for CPU0	RW	Output Disabled	Output Enabled	1
1		PLL1_SSC_ON	Enable PLL1's spread modulation	RW	Spread Disabled	Spread Enabled	1
0		PLL3_SSC_ON	Enable PLL3's spread modulation	RW	Spread Disabled	Spread Enabled	1



Byte 5 Clock Request Enable/Configuration Register

Bit	Pin	Name	Description	Type	0	1	Default
7		CR#_A_EN	Enable CR#_A (clk req), PCI0_OE must be = 0 for this bit to take effect	RW	Disable CR#_A	Enable CR#_A	0
6		CR#_A_SEL	Sets CR#_A to control either SRC0 or SRC2	RW	CR#_A -> SRC0	CR#_A -> SRC2	0
5		CR#_B_EN	Enable CR#_B (clk req)	RW	Disable CR#_B	Enable CR#_B	0
4		CR#_B_SEL	Sets CR#_B -> SRC1 or SRC4	RW	CR#_B -> SRC1	CR#_B -> SRC4	0
3		CR#_C_EN	Enable CR#_C (clk req)	RW	Disable CR#_C	Enable CR#_C	0
2		CR#_C_SEL	Sets CR#_C -> SRC0 or SRC2	RW	CR#_C -> SRC0	CR#_C -> SRC2	0
1		CR#_D_EN	Enable CR#_D (clk req)	RW	Disable CR#_D	Enable CR#_D	0
0		CR#_D_SEL	Sets CR#_D -> SRC1 or SRC4	RW	CR#_D -> SRC1	CR#_D -> SRC4	0

Byte 6 Clock Request Enable/Configuration and Stop Control Register

Bit	Pin	Name	Description	Type	0	1	Default
7		CR#_E_EN	Enable CR#_E (clk req) -> SRC6	RW	Disable CR#_E	Enable CR#_E	0
6		CR#_F_EN	Enable CR#_F (clk req) -> SRC8	RW	Disable CR#_F	Enable CR#_F	0
5		CR#_G_EN	Enable CR#_G (clk req) -> SRC9	RW	Disable CR#_G	Enable CR#_G	0
4		CR#_H_EN	Enable CR#_H (clk req) -> SRC10	RW	Disable CR#_H	Enable CR#_H	0
3		Reserved	Reserved	RW			0
2		Reserved	Reserved	RW			0
1		SSCD_STP_CRTL	If set, LCD_SS stops with PCI_STOP#	RW	Free Running	Stops with PCI_STOP# assertion	0
0		SRC_STP_CRTL	If set, SRCs stop with PCI_STOP#	RW	Free Running	Stops with PCI_STOP# assertion	0

Byte 7 Vendor ID/ Revision ID

Bit	Pin	Name	Description	Type	0	1	Default
7		Rev Code Bit 3	Revision ID	R	Vendor specific		0
6		Rev Code Bit 2		R			0
5		Rev Code Bit 1		R			1
4		Rev Code Bit 0		R			0
3		Vendor ID bit 3	Vendor ID ICS is 0001, binary	R			0
2		Vendor ID bit 2		R			0
1		Vendor ID bit 1		R			0
0		Vendor ID bit 0		R			1

Byte 8 Device ID and Output Enable Register

Bit	Pin	Name	Description	Type	0	1	Default
7		Device_ID3	Table of Device identifier codes, used for differentiating between CK505 package options, etc.	R	See Device ID Table		1
6		Device_ID2		R			1
5		Device_ID1		R			0
4		Device_ID0		R			1
3		Reserved	Reserved	RW	-	-	0
2		Reserved	Reserved	RW	-	-	0
1		SE1_OE	Output enable for SE1	RW	Disabled	Enabled	27_Select power on latch
0		SE2_OE	Output enable for SE2	RW	Disabled	Enabled	27_Select power on latch



Byte 9 Output Control Register

Bit	Pin	Name	Description	Type	0	1	Default
7		PCIF5 STOP EN	Allows control of PCIF5 with assertion of PCI_STOP#	RW	Free running	Stops with PCI_STOP# assertion	0
6		TME_Readback	Trusted Mode Enable (TME) strap status	R	normal operation	no overclocking	0
5		REF Strength	Sets the REF output drive strength	RW	1X (2Loads)	2X (3 Loads)	1
4		Test Mode Select	Allows test select, ignores REF/FSC/TestSel	RW	Outputs HI-Z	Outputs = REF/N	0
3		Test Mode Entry	Allows entry into test mode, ignores FSB/TestMode	RW	Normal operation	Test mode	0
2		IO_VOUT2	IO Output Voltage Select (Most Significant Bit)	RW	See Table 3: V_IO Selection (Default is 0.8V)		1
1		IO_VOUT1	IO Output Voltage Select	RW			0
0		IO_VOUT0	IO Output Voltage Select (Least Significant Bit)	RW			1

Byte 10 Free-Running Control Register

Bit	Pin	Name	Description	Type	0	1	Default
7		27_Select Latch read back	Readback of 27_Select latch	R	Dot96/ LCD_SS /SE	SRC0/ 27MHz	27_Select latch
6		Reserved	Reserved	RW	-	-	1
5		Reserved	Reserved	RW	-	-	1
4		CPU1_AMT_EN*	M1 mode clk enable	RW	Disable	Enable	1
3		Reserved	Reserved	RW	-	-	1
2		CPU 2 Stop Enable*	Enables control of CPU2 with CPU_STOP#	RW	Free Running	Stoppable	1
1		CPU 1 Stop Enable	Enables control of CPU1 with CPU_STOP#	RW	Free Running	Stoppable	1
0		CPU 0 Stop Enable	Enables control of CPU 0 with CPU_STOP#	RW	Free Running	Stoppable	1

*9LPRS355C Only

Byte 11 Strength Control Register

Bit	Pin	Name	Description	Type	0	1	Default
7		48MHz	Strength control	RW	1x	2x	0
6		PCIF5		RW	1x	2x	0
5		PCI4		RW	1x	2x	0
4		PCI3		RW	1x	2x	0
3		PCI2		RW	1x	2x	0
2		PCI1		RW	1x	2x	0
1		PCI0		RW	1x	2x	0
0		Reserved		RW			0

Byte 12 Byte Count Register

Bit	Pin	Name	Description	Type	0	1	Default
7		Reserved	Read Back byte count register, max bytes = 32	RW			0
6		Reserved		RW			0
5		BC5		RW			0
4		BC4		RW			0
3		BC3		RW			1
2		BC2		RW			1
1		BC1		RW			0
0		BC0		RW			1

Byte 13 VCO Frequency Control Register PLL1

Bit	Pin	Name	Description	Type	0	1	Default
7		N Div8	N Divider 8	RW	-	-	X
6		N Div9	N Divider 9	RW	-	-	X
5		M Div5	The decimal representation of M Div (5:0) is equal to reference divider value. Default at power up = latch-in or Byte 0 Rom table.	RW	-	-	X
4		M Div4		RW	-	-	X
3		M Div3		RW	-	-	X
2		M Div2		RW	-	-	X
1		M Div1		RW	-	-	X
0		M Div0		RW	-	-	X



Byte 14 VCO Frequency Control Register PLL1

Bit	Pin	Name	Description	Type	0	1	Default
7		N Div7	The decimal representation of N Div (9:0) is equal to VCO divider value. Default at power up = latch-in or Byte 0 Rom table.	RW	-	-	X
6		N Div6		RW	-	-	X
5		N Div5		RW	-	-	X
4		N Div4		RW	-	-	X
3		N Div3		RW	-	-	X
2		N Div2		RW	-	-	X
1		N Div1		RW	-	-	X
0		N Div0		RW	-	-	X

Byte 15 Spread Spectrum Control Register PLL1

Bit	Pin	Name	Description	Type	0	1	Default
7		SSP7	These Spread Spectrum bits will program the spread percentage. Contact ICS for the correct values.	RW	-	-	X
6		SSP6		RW	-	-	X
5		SSP5		RW	-	-	X
4		SSP4		RW	-	-	X
3		SSP3		RW	-	-	X
2		SSP2		RW	-	-	X
1		SSP1		RW	-	-	X
0		SSP0		RW	-	-	X

Byte 16 Spread Spectrum Control Register PLL1

Bit	Pin	Name	Description	Type	0	1	Default
7		Reserved	Reserved	RW	-	-	0
6		SSP14	These Spread Spectrum bits will program the spread percentage. Contact ICS for the correct values.	RW	-	-	x
5		SSP13		RW	-	-	X
4		SSP12		RW	-	-	X
3		SSP11		RW	-	-	X
2		SSP10		RW	-	-	X
1		SSP9		RW	-	-	X
0		SSP8		RW	-	-	X

Byte 17 VCO Frequency Control Register PLL3

Bit	Pin	Name	Description	Type	0	1	Default
7		N Div8	N Divider 8	RW	-	-	X
6		N Div9	N Divider 9	RW	-	-	X
5		M Div5	The decimal representation of M Div (5:0) is equal to reference divider value. Default at power up = latch-in or Byte 0 Rom table.	RW	-	-	X
4		M Div4		RW	-	-	X
3		M Div3		RW	-	-	X
2		M Div2		RW	-	-	X
1		M Div1		RW	-	-	X
0		M Div0		RW	-	-	X

Byte 18 VCO Frequency Control Register PLL3

Bit	Pin	Name	Description	Type	0	1	Default
7		N Div7	The decimal representation of N Div (9:0) is equal to VCO divider value. Default at power up = latch-in or Byte 0 Rom table.	RW	-	-	X
6		N Div6		RW	-	-	X
5		N Div5		RW	-	-	X
4		N Div4		RW	-	-	X
3		N Div3		RW	-	-	X
2		N Div2		RW	-	-	X
1		N Div1		RW	-	-	X
0		N Div0		RW	-	-	X



Byte 19 Spread Spectrum Control Register PLL3

Bit	Pin	Name	Description	Type	0	1	Default
7		SSP7	These Spread Spectrum bits will program the spread percentage. Contact ICS for the correct values.	RW	-	-	X
6		SSP6		RW	-	-	X
5		SSP5		RW	-	-	X
4		SSP4		RW	-	-	X
3		SSP3		RW	-	-	X
2		SSP2		RW	-	-	X
1		SSP1		RW	-	-	X
0		SSP0		RW	-	-	X

Byte 20 Spread Spectrum Control Register PLL3

Bit	Pin	Name	Description	Type	0	1	Default
7		Reserved	Reserved	RW	-	-	0
6		SSP14	These Spread Spectrum bits will program the spread percentage. Contact ICS for the correct values.	RW	-	-	x
5		SSP13		RW	-	-	X
4		SSP12		RW	-	-	X
3		SSP11		RW	-	-	X
2		SSP10		RW	-	-	X
1		SSP9		RW	-	-	X
0		SSP8		RW	-	-	X

Byte 21 M/N Enables

Bit	Pin	Name	Description	RW	0	1	Default
7		Reserved		RW			0
6		Reserved		RW			0
5		Reserved		RW			0
4		Reserved		RW			0
3		Reserved		RW			0
2		Reserved		RW			0
1		Reserved		RW			0
0		M/N Enable	M/N Enable	RW	Disable	Enable	0

*These bits are disabled if TME is latched to 1



Test Clarification Table

Comments	HW		SW		OUTPUT
	FSLC/ TEST_SEL HW PIN	FSLB/ TEST_MODE HW PIN	TEST ENTRY BIT B9b3	REF/N or HI-Z B9b4	
	<2.0V	X	0	0	NORMAL
Power-up w/ TEST_SEL = 1 to enter test mode	>2.0V	0	X	0	HI-Z
Cycle power to disable test mode	>2.0V	0	X	1	REF/N
FSLC./TEST_SEL -->3-level latched input	>2.0V	1	X	0	REF/N
If power-up w/ V>2.0V then use TEST_SEL					
If power-up w/ V<2.0V then use FSLC					
FSLB/TEST_MODE -->low Vth input	>2.0V	1	X	1	REF/N
TEST_MODE is a real time input					
If TEST_SEL HW pin is 0 during power-up, test mode can be invoked through B9b3.	<2.0V	X	1	0	HI-Z
If test mode is invoked by B9b3, only B9b4 is used to select HI-Z or REF/N	<2.0V	X	1	1	REF/N
FSLB/TEST_Mode pin is not used.					
Cycle power to disable test mode, one shot control					

B9b3: 1= ENTER TEST MODE, Default = 0 (NORMAL OPERATION)

B9b4: 1= REF/N, Default = 0 (HI-Z)

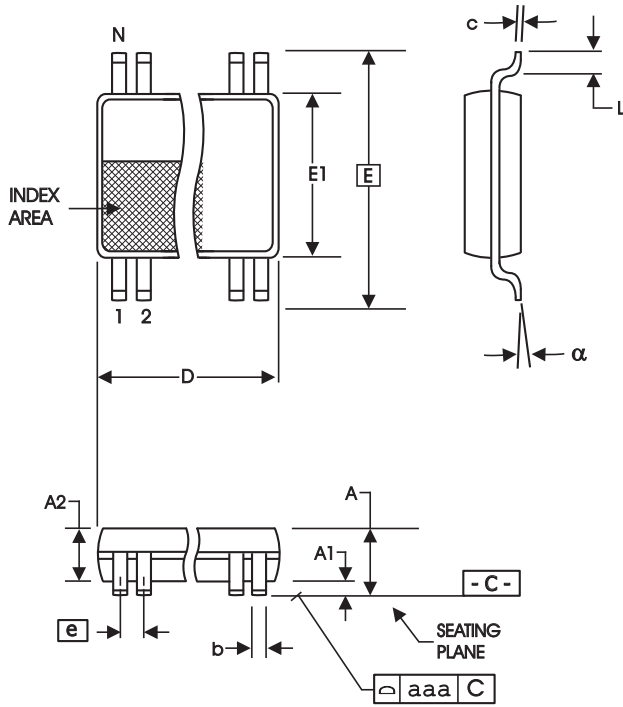

6.10 mm. Body, 0.50 mm. Pitch TSSOP
(240 mil) (20 mil)

SYMBOL	In Millimeters COMMON DIMENSIONS		In Inches COMMON DIMENSIONS	
	MIN	MAX	MIN	MAX
A	--	1.20	--	.047
A1	0.05	0.15	.002	.006
A2	0.80	1.05	.032	.041
b	0.17	0.27	.007	.011
c	0.09	0.20	.0035	.008
D	SEE VARIATIONS		SEE VARIATIONS	
E	8.10 BASIC		0.319 BASIC	
E1	6.00	6.20	.236	.244
e	0.50 BASIC		0.020 BASIC	
L	0.45	0.75	.018	.030
N	SEE VARIATIONS		SEE VARIATIONS	
α	0°	8°	0°	8°
aaa	--	0.10	--	.004

VARIATIONS

N	D mm.		D (inch)	
	MIN	MAX	MIN	MAX
64	16.90	17.10	.665	.673

Reference Doc.: JEDEC Publication 95, MO-153

10-0039

Ordering Information

9LPRS355BGLFT

Example:

XXXX y G LFT

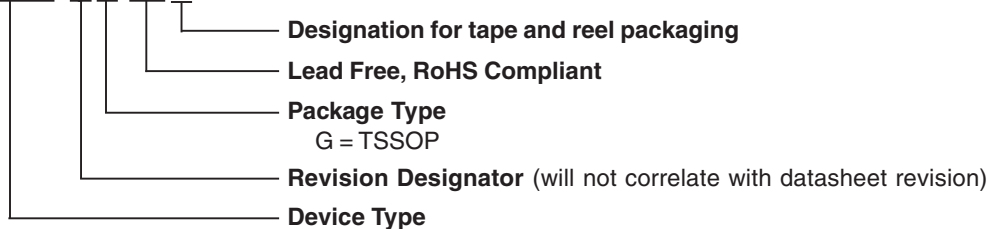

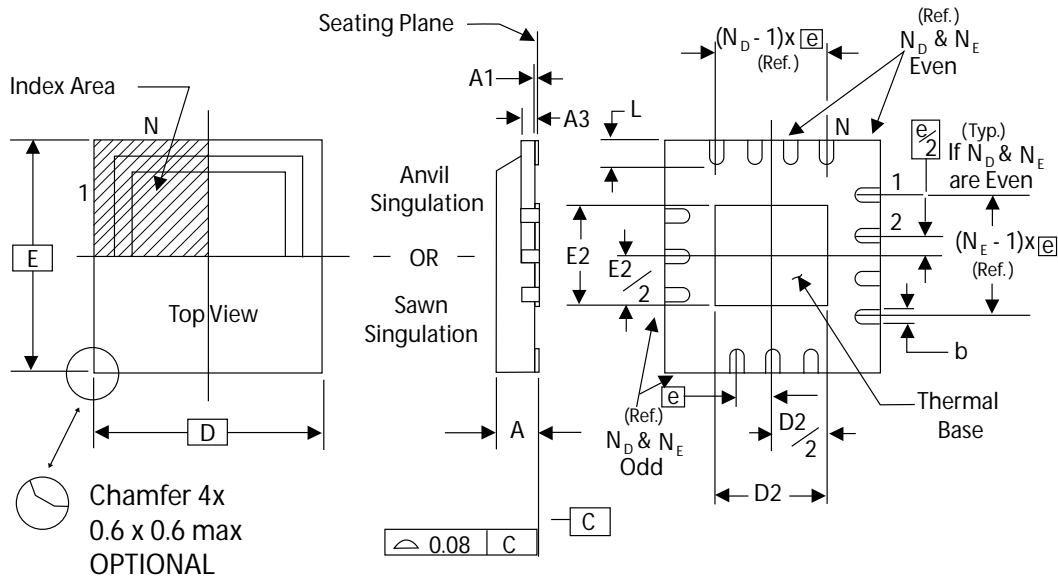

**THERMALLY ENHANCED, VERY THIN, FINE PITCH
QUAD FLAT / NO LEAD PLASTIC PACKAGE**

DIMENSIONS

SYMBOL	64L
N	64
N _D	16
N _E	16

OPTION 1 DIMENSIONS (mm)

SYMBOL	MIN.	MAX.
A	0.8	1.0
A1	0	0.05
A3	0.25 Reference	
b	0.18	0.3
e	0.50 BASIC	
D x E BASIC	9.00 x 9.00	
D2 MIN. / MAX.	7.00	7.25
E2 MIN. / MAX.	7.00	7.25
L MIN. / MAX.	0.30	0.50

OPTION 2 DIMENSIONS (mm)

SYMBOL	MIN.	MAX.
A	0.8	1.0
A1	0	0.05
A3	0.25 Reference	
b	0.18	0.3
e	0.50 BASIC	
D x E BASIC	9.00 x 9.00	
D2 MIN. / MAX.	6.00	6.25
E2 MIN. / MAX.	6.00	6.25
L MIN. / MAX.	0.30	0.50

Ordering Information

9LPRS355BKLFT

*Due to package size constraints actual top side marking may differ from the full orderable part number.

Example:

XXXX y K LFT

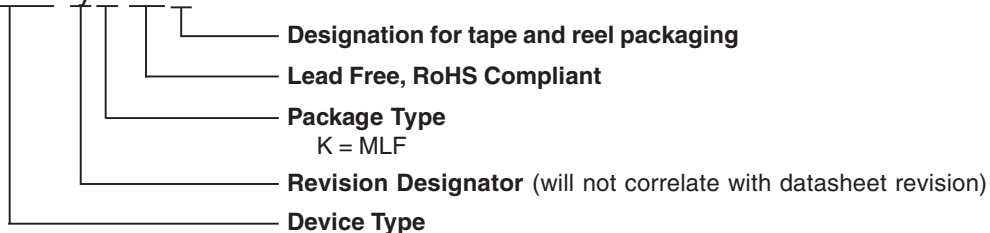



Revision History

Rev.	Issue Date	Description	Page #
A	6/24/2014	Moved to final.	Various