

SPEAKER-916-3-S9-WILDCAT-O-950

The 9 x 16 x 3 mm rectangular WILDCAT speaker is a high end miniature speaker specifically designed for portable devices, music phones and smartphones where high quality sound is required.

The use of a high performance magnet system leads to high sensitivity and coupled with a power handling capacity of 700mW. It enables extremely high sound pressure for the loudest 9x16x3mm speaker currently available on the market.

All materials used on the top surface of the speaker are tested to be water resistant. 100% leak measurement guarantees IPx8 waterproof compliance.

In addition to waterproof compliance this component provides the same performance as the standard Wildcat speaker device (available under part number 2403 263 00165).

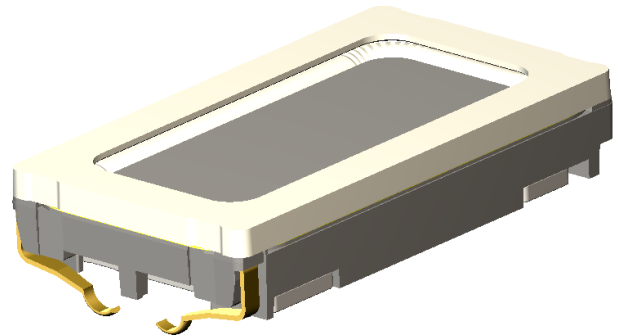

Features:

- Best-in-class 75dB (1W, 1m) sensitivity
- Maximum power handling capacity: 700mW
- Low THD between 4 and 8kHz due to lightweight membrane technology
- Designed for N'Bass™ - ultimate sound experience combined with Knowles N'Bass™ technology
- Industry-standard dimensions: 9x16x3.0mm
- 100% in-line measurement of all specified acoustical and electrical parameters

n'bass™

Virtual Back Volume Technology

Contents

1. Theory of Operation	3
2. Mechanical Layout and Dimensions.....	4
2.1. Main Dimensions.....	4
2.2. PWB Layout & electric polarity	5
2.3. Magnetic polarity	5
2.4. Spring Force.....	6
2.5. Forces on Component	7
2.6. Part Marking/Labeling.....	8
2.7. Material List.....	9
2.8. Water/ gas tightness	9
Electrical and Acoustical Specifications.....	10
2.9. Frequency Response and THD.....	10
2.10. Electro-Acoustic Parameters	11
2.11. Power Handling	11
2.12. Measurement Setup.....	12
2.13. Measured Parameters.....	12
2.14. Measurement adapter	13
3. Environmental Conditions.....	14
3.1. Storage.....	14
3.2. Transportation.....	14
3.3. Functionality.....	14
4. Environmental Tests.....	15
4.1. Qualification Tests.....	15
4.2. Reliability Tests.....	15
4.3. Sample Size, Sequence	15
4.4. Period of Shelf-Life	15
4.5. Testing Procedures	15
Related Documents	20
5. Change History	21
6. Disclaimer	21

1. Theory of Operation

SPEAKER-916-3-S9-WILDCAT-O-950 is a high end micro size speaker specifically designed for mobile phones and other mobile applications where high quality sound is needed and only very little space for components is available.

2. Mechanical Layout and Dimensions

2.1. Main Dimensions

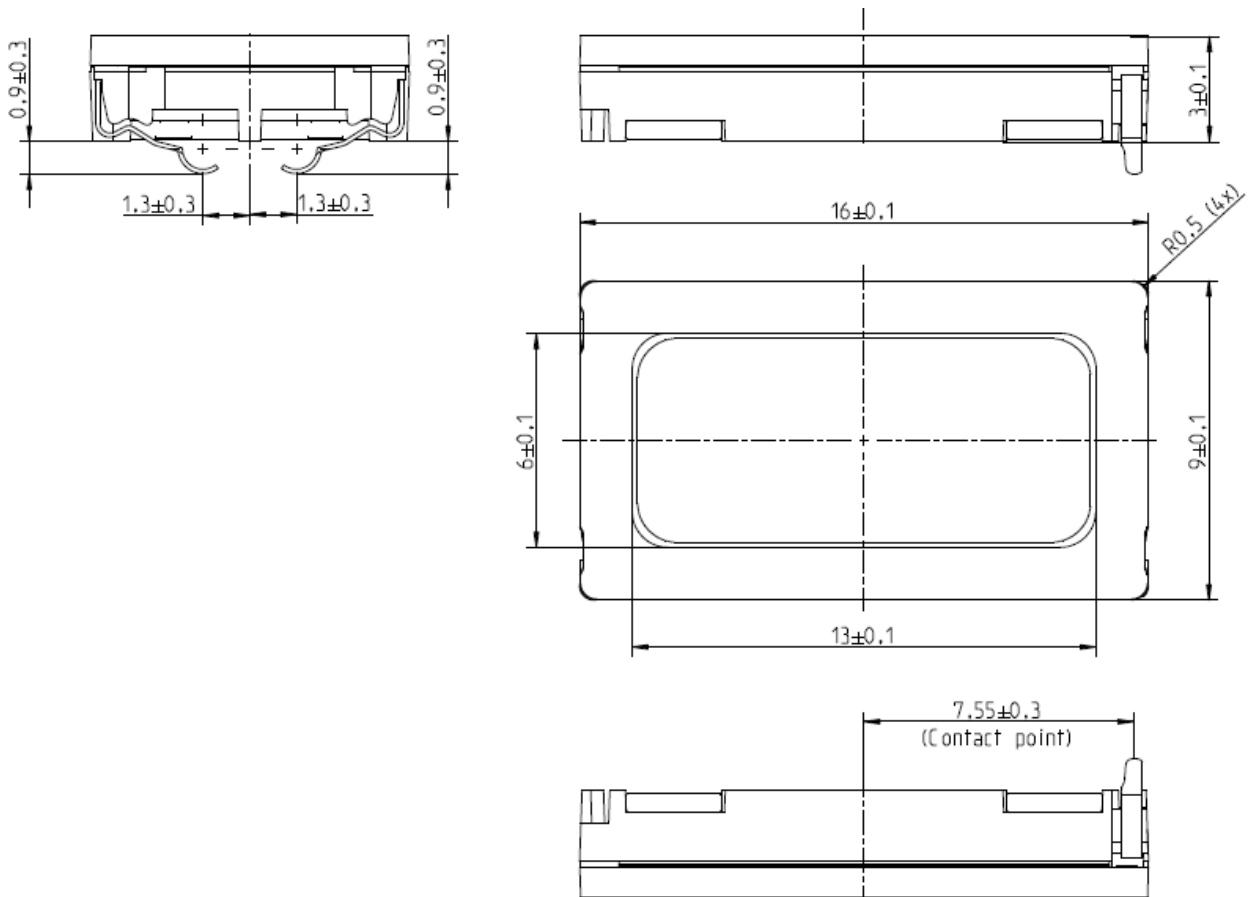

2.2. PWB Layout & electric polarity

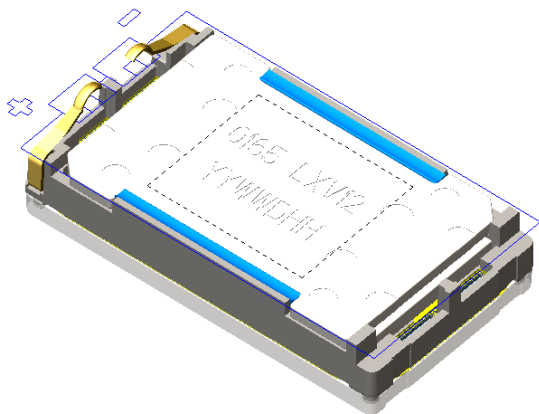
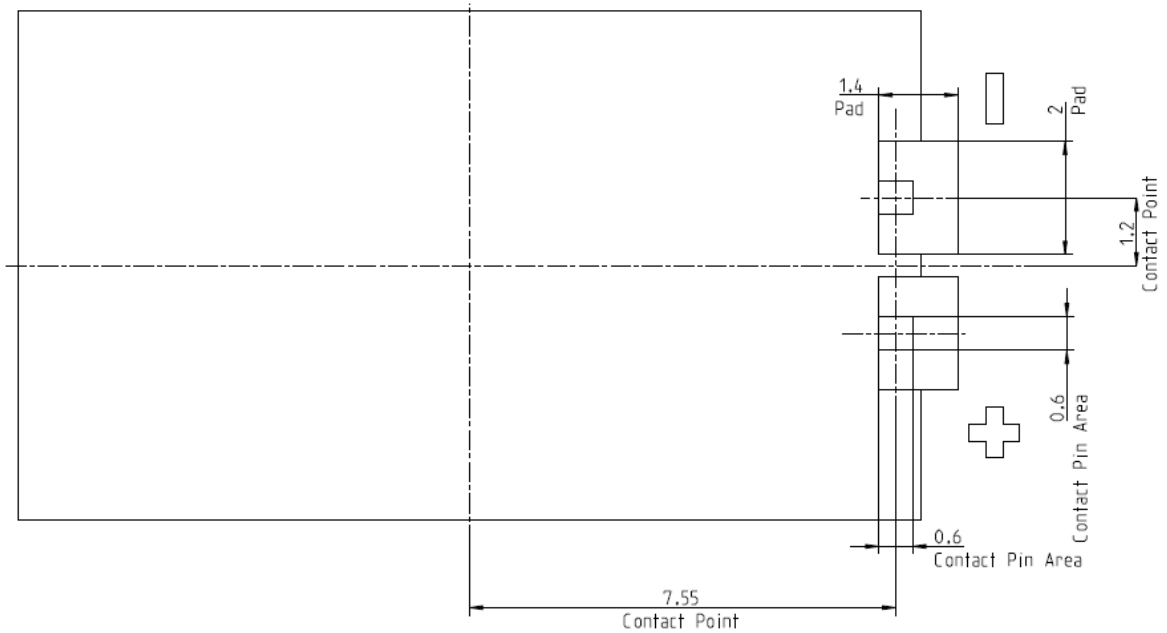

2.3. Magnetic polarity

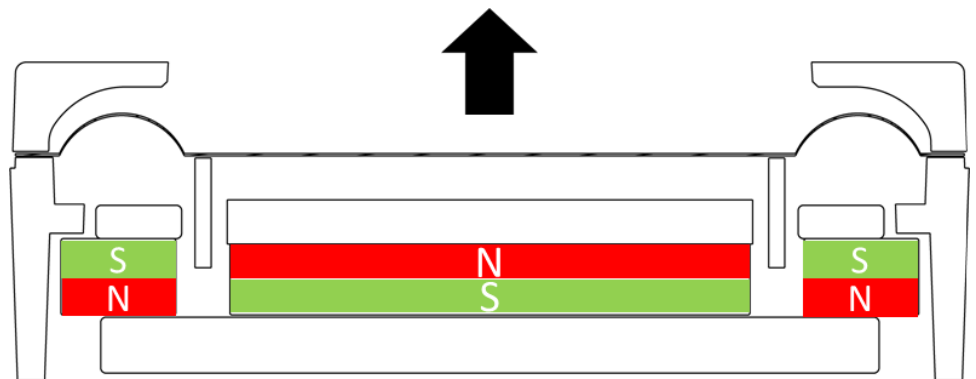
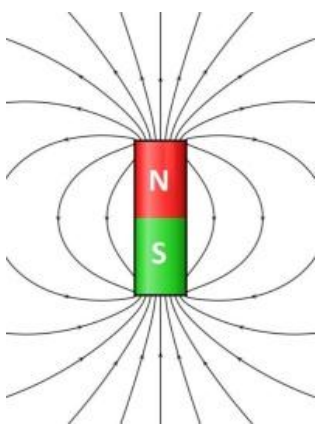

Positive voltage on pin +
Moves the membrane in direction of arrow

2.4. Spring Force

Ra 9x16x3 springforce

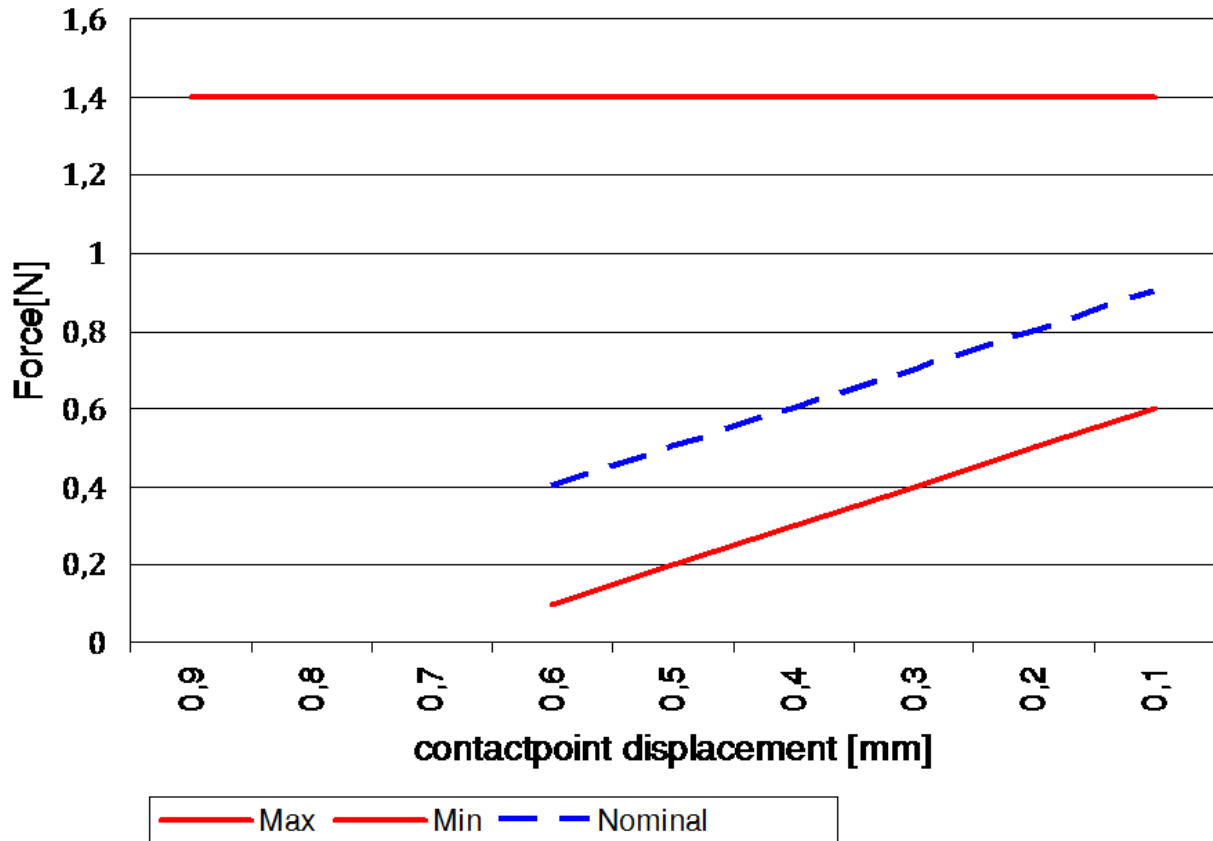

2.5. Forces on Component

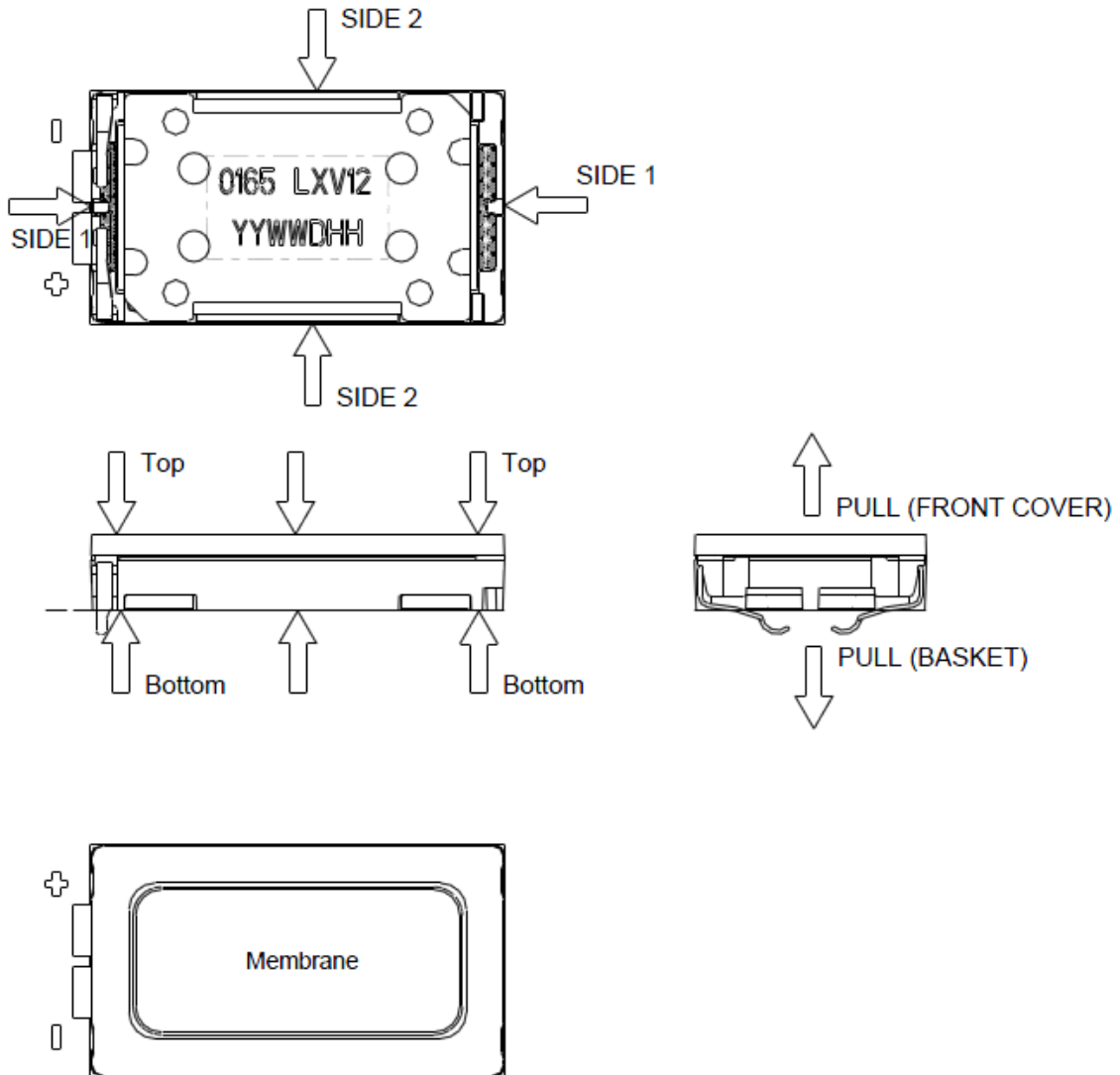

STATE	MINIMUM AREA OF FORCE APPLIED [mm ²]	MAXIMUM PERMANENT FORCE [N]	MAXIMUM HANDLING FORCE [N]
FROM FRONT (DISTRIBUTED TO GASKET AREA TO BACK (BASKET))	-	10	25
FROM SIDE 1 TO SIDE 1	3	10	20
FROM SIDE 2 TO SIDE 2	10	10	20
TO POT	-	10	25
TO MEMBRANE	-	0	0
PULL OFF FORCE (COVER/BASKET)	-	-	10

2.6. Part Marking/Labeling

The products have a serial number on bottom side, and laser on POT

Auto Line/ Semi Line:

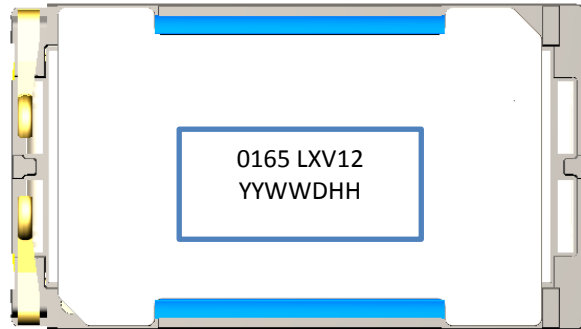

BAR CODE: XXXXLXV121412411

Position	Item	Example
1	Product 12NC [last 4 digitals]	0165
2	Production Line	LX
3	Product Version	V12
4	Year/Week/Date/Time	1412411

XXXX LX V12 14 12 4 11

Last 4 digitals of 12NC
 Production line
 Production version
 Year
 Week
 Date
 Time

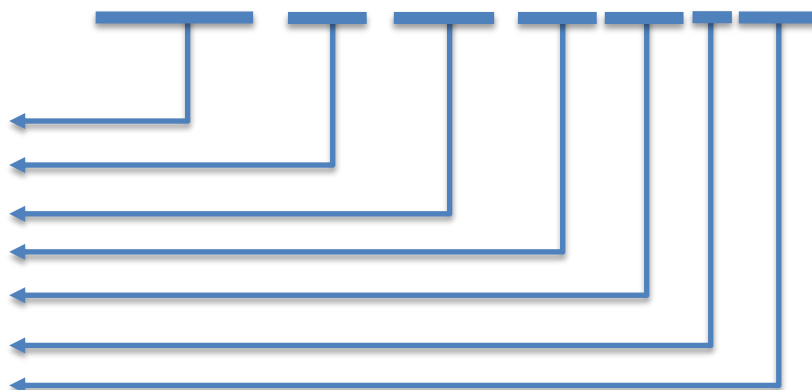

2.7. Material List

- | | |
|--------------------------|-------------------------|
| 1. Material of basket: | Polycarbonate |
| 2. Material of membrane: | PEEK-Compound |
| 3. Material of pot: | Soft magnetic Iron |
| 4. Material of magnet: | Nd Fe B |
| 5. Material of contact | CrNi-Steel, gold plated |
| 6. Material of cover: | Polycarbonate |
| 7. Dimensions: | 9x16x3.0mm |
| 8. Mass: | 1.2g |

2.8. Water/ gas tightness

The products are 100% tested for leaks between cover and membrane.

- Method: Differential pressure measurement
Down force on cover: 5 +/- 1 N
Air pressure: 15 Kpa
Allowed leakage: <133pa at duration of 10s
Air pressure direction: blow from membrane to magnet side

Electrical and Acoustical Specifications

Typical frequency response measured on baffle acc. Chapter 2.12
 distance $d=10\text{cm}$, with rear volume 1cm^3 at 2.37V (700mW)

2.9. Frequency Response and THD

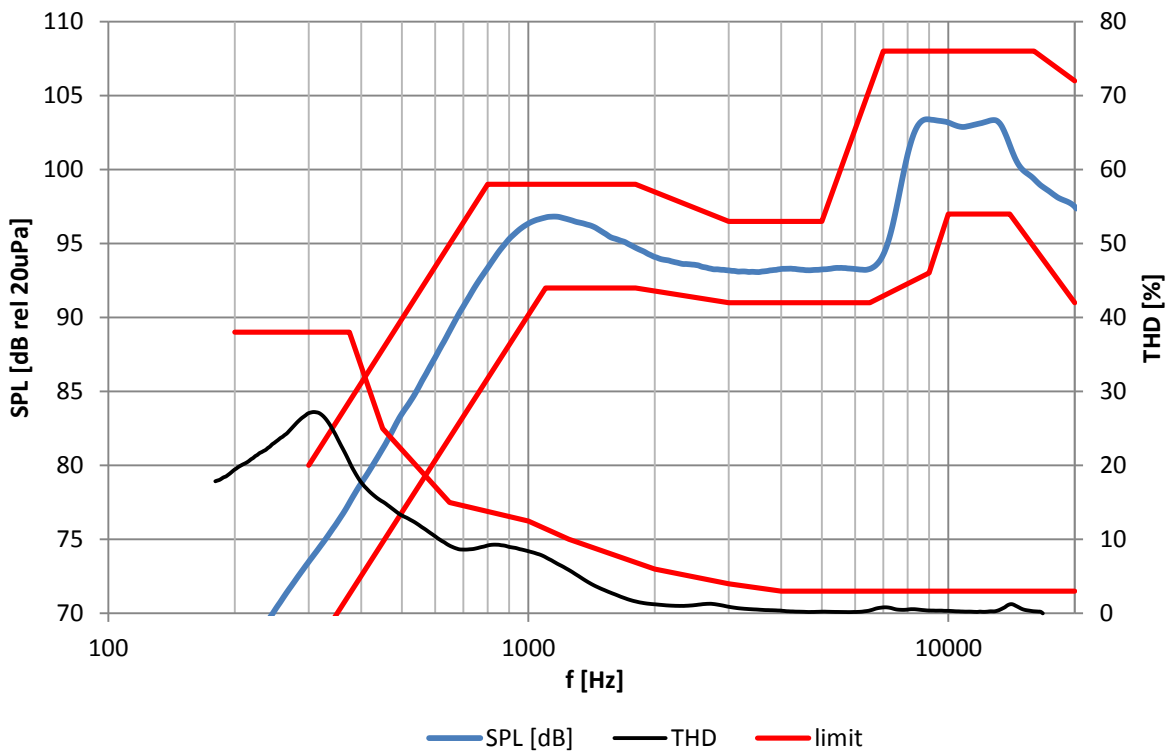

Tolerance window					
f [Hz]	lower limit [dB SPL] (floating)	f [Hz]	upper limit [dB SPL] (floating)	F [Hz]	upper limit [%THD]
300	67	300	80	200	38
1100	92	800	99	375	38
1800	92	1800	99	450	25
3000	91	3000	97	650	15
6500	91	5000	97	1000	13
9000	93	7000	108	1250	10
10000	97	16000	108	2000	6
14000	97	20000	106	3000	4
20000	91			4000	3
				20000	3

2.10. Electro-Acoustic Parameters

Loudspeaker mounted in adapter acc. to 2.11 and 2.13. Measurement signal: Logarithmic sine sweep, 1.5s, 22kHz-180Hz. All acoustic measurements at 23±2°C.

1. Rated impedance	Z:	8Ω
2. Voice coil resistance	R:	6.9Ω±10%
3. Resonance frequency (in 1cm ³ rear volume @ 700mW)	f _C :	950Hz±7.5%
3.1 Typical resonance frequency without rear volume	f _S :	510Hz
4. Maximum usable excursion x _{max}	p-p:	0.64mm _{p-p}
5. Nominal characteristic sensitivity (measured at 1V in 10cm, calculated to 1W, 1m average from 2kHz to 4.5kHz)		75±2dB
5.1. Measured characteristic sensitivity (at 700mW in 10cm) average from 2kHz to 4.5kHz, thermal compression included		92,8±2dB
6. THD	according chapter 2.9	
7. Rub & Buzz	no audible R&B at max sine power	

2.11. Power Handling

Speaker mounted in test device 1cm³ rear volume (open front).

1. Max sine power		700mW
2. Max short term power (thermal limit test: pink noise, 2 nd order high pass filtered, -3dB at 1kHz, crest factor 2)	(70°, 1sec. ON / 60sec. OFF)	1000mW (RMS)
3. Max continuous power (pink noise, 2 nd order high pass filtered, -3dB at 400Hz, crest factor 2)	(70°, 500h)	700mW (RMS)

2.12. Measurement Setup

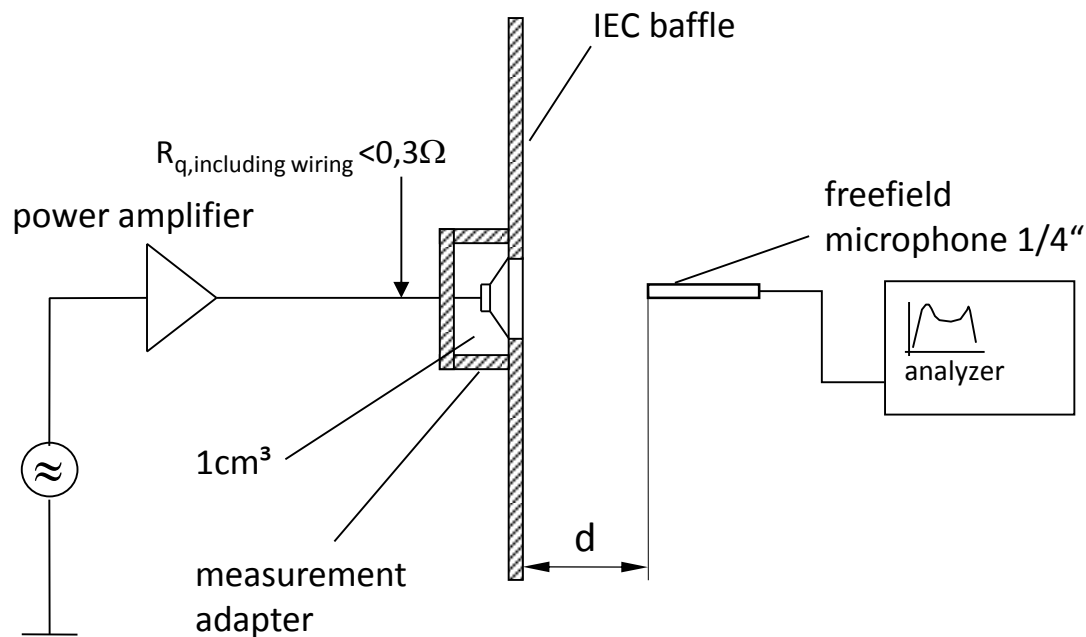

Measurement signal: Logarithmic sine sweep, 1.5s, 22kHz-180Hz

2.13. Measured Parameters

2.13.1. Sensitivity

SPL is expressed in dB rel $20\mu\text{Pa}$, computed according to IEC 268-5. Measurement set up and parameters according chapter 2.11. This test is performed for 100% of products in the production line.

2.13.2. Frequency response

Frequency response is measured according test set up in chapter 2.11. data sheet and checked against the tolerance window defined in chapter 2.8. This Test is performed for 100% of products in the production line.

2.13.3. Total harmonic distortion (THD)

Is measured according IEEE 1241 (2nd to 5th harmonics) and test set up in chapter 2.11. This test is performed for 100% of products in the production line.

2.13.4. Rub & Buzz

Rub & Buzz will be measured in the Inline-measuring device with a sinusoidal sweep. Rub & Buzz is defined as the maximum level of signal energy in a certain frequency-range. Signal and evaluation criteria are according to chapter 3.3. This test is performed for 100% of products in the production line.

2.14. Measurement adapter

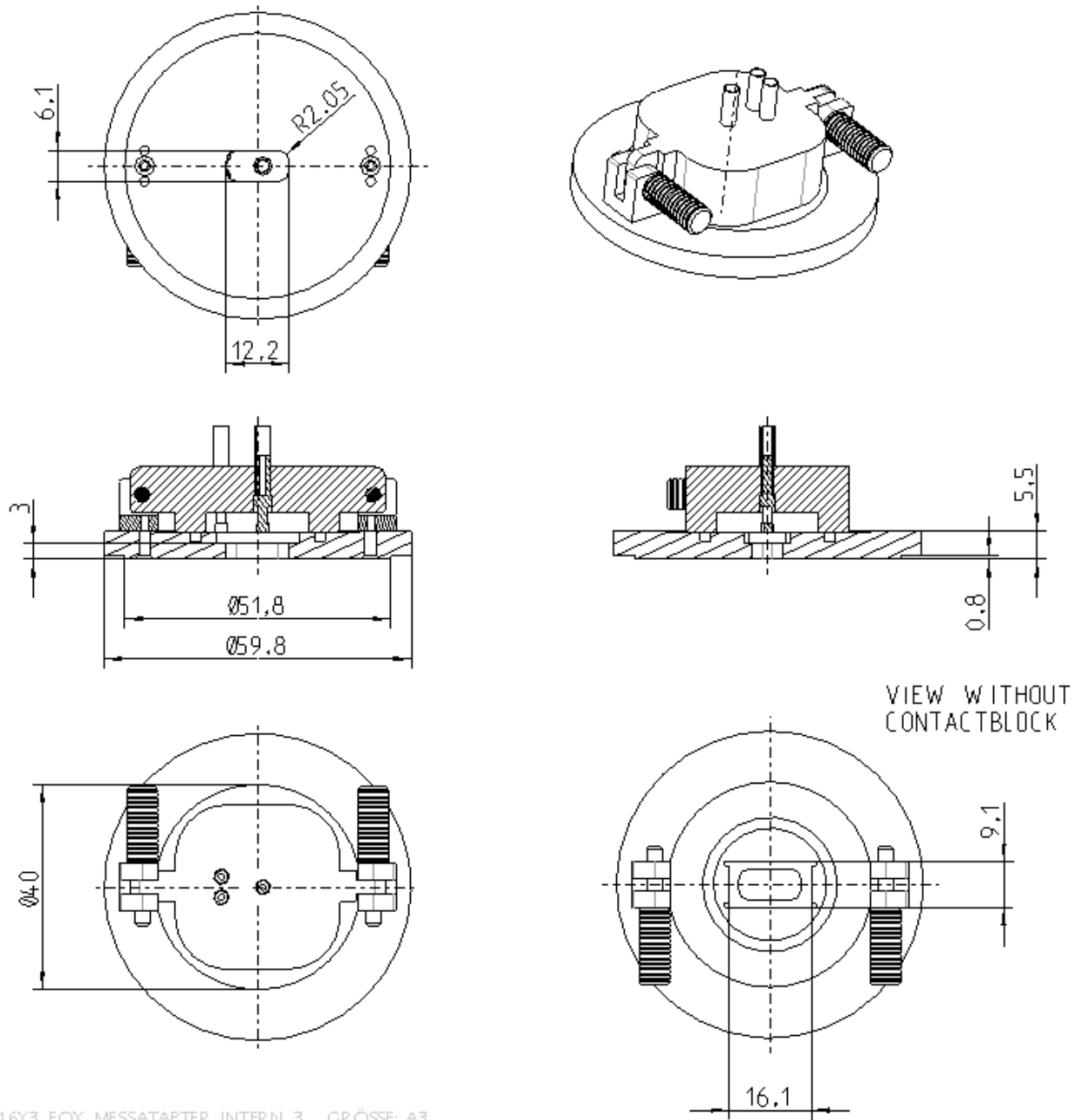

16X3 FOX MESSADAPTER INTERN 3 GRÖSSE A3

3. Environmental Conditions

3.1. Storage

The transducer fulfills the specified data after treatment according to the conditions of

ETS 300 019-2-1 Specification of environmental test: Storage
Test spec. T 1.2: Weather protected, not temperature controlled storage locations.

3.2. Transportation

The transducer fulfills the specified data after treatment according to the conditions of

ETS 300 019-2-2 Specification of environmental test: Transportation
Test Spec. T 2.3: Public Transportation

3.3. Functionality

The transducer fulfills the specified data after treatment according to the conditions of

ETS 300 019-2-5 Specification of environmental test: Ground vehicle installations
Test spec. T 5.1: Protected installation

ETS 300 019-2-7 Specification of environmental test: Portable and non-stationary use
Test spec. T 7.3E: Partly weather protected and non-weather protected locations.

4. Environmental Tests

4.1. Qualification Tests

A complete qualification test will be done at design validation of products manufactured under serial conditions.

1x per year and product family a requalification takes place. The qualification process covers all tests described under 4.5 and a complete inspection.

4.2. Reliability Tests

1x per month and product family samples are taken and submitted to tests described under 4.5.2

4.3. Sample Size, Sequence

Unless otherwise stated 20 arbitrary new samples will be used to perform each test for both, qualification and requalification test as described under 4.1 and 4.2.

4.4. Period of Shelf-Life

The period of shelf-life is 2 years.

4.5. Testing Procedures

4.5.1. Storage Tests

4.5.1.1. Cold Storage Test

Parameter	Test Method and Conditions	Duration	Evaluation Standard
Low Temperature Storage (Ref. EN 60068-2-1)	-40°C rel. humidity not controlled	168h	Measurements after 2 hours recovery time. All samples fully operable. All acoustical parameters according specification with tolerances increased by 50 %.

4.5.1.2. Heat Storage Test

Parameter	Test Method and Conditions	Duration	Evaluation Standard
Dry Heat Storage (Ref. EN 60068-2-2)	+85°C rel. humidity not controlled	168h	Measurements after 2 hours recovery time. All samples fully operable. All acoustical parameters according specification with tolerances increased by 50 %.

4.5.1.3. Temperature Cycle Test

Parameter	Test Method and Conditions	Duration	Evaluation Standard
Change of Temperature (Ref. EN 60068-2-14)	-40°C/+85°C Transition time <3 min. See Figure 4-1 below	5 cycles >2h for each temperature	Measurements after 2 hours recovery time. All samples fully operable. All acoustical parameters according specification with tolerances increased by 50 %.

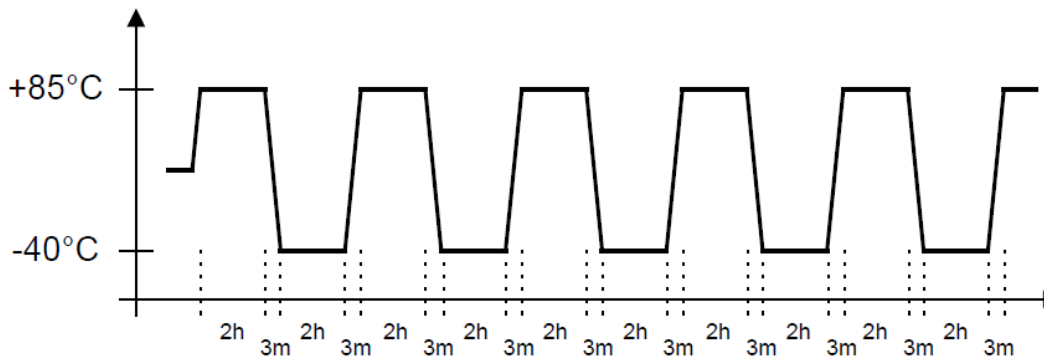

Figure 4-1: Temperature Cycle Test

4.5.1.4. Temperature / Humidity Cycle Test

Parameter	Test Method and Conditions	Duration	Evaluation Standard
Damp heat, cyclic (Ref. IEC 60068-2-30)	+25°C/+55°C 90% to 95% RH. Temp. change time <3h See Figure 4-2 below <u>Caution:</u> no condensed water on products!	6 cycles / 144h 12h at each temperature (inclusive temp ramp up/down)	Measurements after 2 hours recovery time. All samples fully operable. All acoustical parameters according specification with tolerances increased by 50 %.

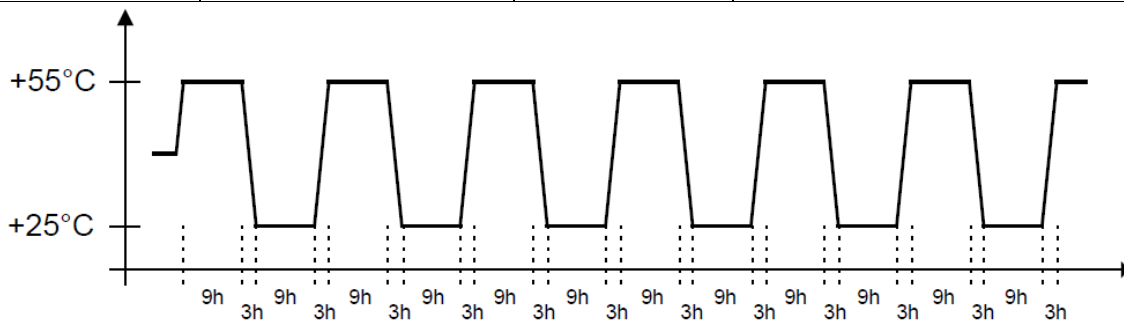

Figure 4-2: Temperature / Relative Humidity Cycle Test

4.5.2. Operating Tests

4.5.2.1. Cold Operation Test

Parameter	Test Method and Conditions	Duration	Evaluation Standard
Cold Operation Test (Ref. EN 60068-2-1)	-20°C rel. humidity not controlled signal acc. Chapter 2.10	72h	Measurements after 2 hours recovery time. All samples fully operable. THD may be increased after test. All other acoustical parameters according specification with tolerances increased by 50 %.

4.5.2.2. Dry Heat Operation Test

Parameter	Test Method and Conditions	Duration	Evaluation Standard
Dry Heat Operation (Ref. EN 60068-2-2)	+70°C rel. humidity not controlled signal acc. Chapter 2.10	500h	Measurements after 2 hours recovery time. All samples fully operable. The allowable change in sensitivity shall not be greater than 3 dB. All other acoustical parameters according specification with tolerances increased by 50 %.

4.5.3. Salt Mist Test

Parameter	Test Method and Conditions	Duration	Evaluation Standard
Salt Mist (Ref. IEC60068-2-52, Kb / Severity 2)	The part must be subjected to 2 hours spray of 5% NaCl salt mist, at 35°C then be left at 40°C and 95% RH for 22h.	3 cycles	The samples shall be washed after the test with distilled water and dried at T < 50°C. Component may have reduced performance, but must still function properly. The allowable sensitivity difference shall not be greater than ±3dB from initial sensitivity.

4.5.4. Guided Free Fall Test - Protected Product

Parameter	Test Method and Conditions	Conditions / Sample size	Evaluation Standard
Mechanical shock (Ref. IEC60068-2-32 Ed), Procedure 1	Speaker in drop test box or representative mechanics from a height of 1.5m onto concrete floor.	30 units Two drops on each side (2x6) One drop on each edge (1x12) Two drops on each corner (2x8) (40 drops in total)	Component may have reduced performance, but must still function properly. The allowable sensitivity difference shall not be greater than ± 3 dB from initial sensitivity.

4.5.5. Random Free Fall Test (Tumble Test) – Protected Product

Parameter	Test Method and Conditions	Conditions / Sample size	Evaluation Standard
Impact durability (in a Tumble Tester) (Ref. IEC60068-2-32 Ed) (SPR a7.1.1)	Speaker in drop test box or representative mechanics. Random drops on steel base.	30 units 300 drops, 1m DUT power off	Component may have reduced performance, but must still function properly. The allowable sensitivity difference shall not be greater than ± 3 dB from initial sensitivity.

4.5.6. Resistance to Electrostatic Discharge

Parameter	Test Method and Conditions	Conditions / Sample size	Evaluation Standard
Resistance to ESD IEC61000-4-2 Level 4 (SPR c 2.5.1)	One pole is grounded and the ESD pulse is applied to the other pole. The speaker must be stressed first with one polarisation and then with the other polarisation. DUT must be discharged between each ESD exposure. Level 4: contact +/- 8kV, air +/- 15kV	10 exposures on each polarity / 5 units DUT Power off	All samples fully operable. All acoustical parameters according specification with tolerances increased by 50%.

4.5.7. DC endurance

Parameter	Test Method and Conditions	Conditions / Sample size	Evaluation Standard
DC endurance	Apply $\pm 1.5V$ DC voltage to the speaker for 3 minutes	5 units per each voltage polarity	All samples fully operable. All acoustical parameters according specification with tolerances increased by 50%.

Related Documents

IEC 268-5	Sound System equipment Part 5: Loudspeaker
IEEE 1241	Terminology and test methods for analog-to-digital converters
IEC 68-2	Environmental testing
EN 60068-2	Environmental testing
ISO 2859 - 1	Sampling procedures for inspection by attributes Part 1: Sampling plans indexed by acceptable quality level (AQL) for lot-by-lot inspection
ISO 3951	Sampling procedures and charts for inspection by variables for percent defectives.
ETS 300 019-2-1	Specification of environmental test: Storage Test spec. T 1.2: Weather protected, not temperature controlled storage locations
ETS 300 019-2-2	Specification of environmental test: Transportation Test spec. T 2.3: Public Transportation
ETS 300 019-2-5	Specification of environmental test: Ground vehicle installations Test spec. T 5.1: Protected installation
ETS 300 019-2-7	Specification of environmental test: Portable and non-stationary use Test spec. T 7.3E: Partly weather protected and non-weather protected locations

5. Change History

Status	Version	Date	ECR	Comment / Changes	Initials of owner
Release	A	23.12.14		First Release	Henry / Dean

6. Disclaimer

Stresses above the Absolute Maximum Ratings may cause permanent damage to the device. These are stress ratings only. The device may not function when operated at these or any other conditions beyond those indicated under “Electrical and Acoustical Specifications”. Exposure beyond those indicated under “Electrical and Acoustical Specifications” for extended periods may affect device reliability.

This product is not qualified for use in automotive applications

Frequency range for Telecom use

The information contained in this literature is based on our experience to date and is believed to be reliable and it is subject to change without notice. It is intended as a guide for use by persons having technical skill at their own discretion and risk. We do not guarantee favorable results or assume any liability in connection with its use. Dimensions contained herein are for reference purposes only. For specific dimensional requirements consult factory. This publication is not to be taken as a license to operate under, or recommendation to infringe any exiting patents. This supersedes and voids all previous literature.