

HC5

High Power Resonant Capacitors

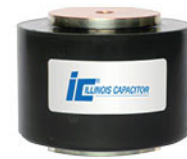

FEATURES

High AC Voltage - High current

APPLICATIONS

Induction Heating - Tank Circuits

KVAR	500
CAPACITANCE TOLERANCE	+/-10%
MAXIMUM CORE TEMPERATURE	+85°C
SURFACE TEMPERATURE	+45°C (Above 45°C the KVAR rating must be de-rated by 2.25%/°C)
CONSTRUCTION	Self-healing
SELF INDUCTANCE	<3 nH
DIELECTRIC	Polypropylene
FLAME RETARDANT	UL94V0

Standard part listing

Capacitance (µF)	VAC	IC part number	Maximum RMS current (A)	MAX power kvar	Frequency range (kHz)	ESR (mΩ) 100kHz, +25°C	Dimensions (mm)			Terminal Style
							D	H	d	
1.2	1100	125HC5112KR	600	500	55-96	1.5	80	71.5	60	R
1.4	1100	145HC5112KR	600	500	46-83	1.2	80	71.5	60	R
3.0	750	305HC5750KR	800	500	47-68	1.1	80	71.5	60	R
3.3	750	335HC5750KR	800	500	43-62	1.0	80	71.5	60	R
4.0	900	405HC5900KR	700	500	25-39	0.9	102	71.5	60	R
5.6	700	565HC5700KR	1000	500	29-57	0.9	80	71.5	60	R
6.3	700	635HC5700KR	1000	500	26-51	0.8	80	71.5	60	R
8.5	700	855HC5700KR	1000	500	19-38	0.7	88	71.5	60	R
10	700	106HC5700KR	1000	500	16-32	0.6	95	71.5	60	R
21	500	216HC5500KR	1000	500	15	0.4	80	71.5	60	R
27	550	276HC5550KR	1000	500	10-12	0.3	102	71.5	60	R
33	500	336HC5500KR	1000	500	10	0.3	102	71.5	60	R
37	500	376HC5500KR	1000	500	9	0.2	102	71.5	60	R



Your Global Source for World-Class Capacitors

© 2013 Illinois Capacitor, Inc.

North America
Tel: 847.675.1760
sales@illcap.com

Asia
Tel: 852.2793 0931
sales@illcap.com.hk

HC5

High Power Resonant Capacitors

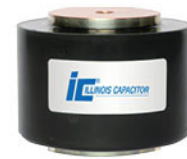

Terminal Style: R

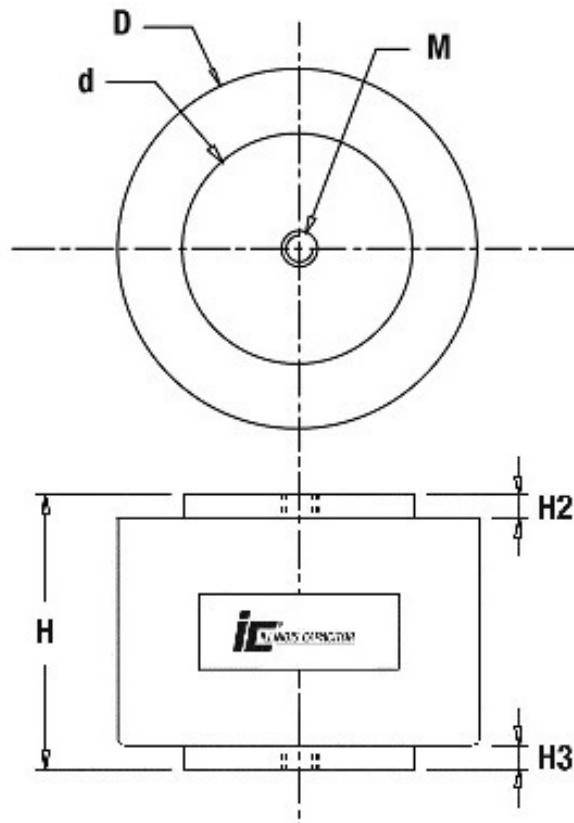

D	H	d	H2	H3
80 \pm 1	71.5 \pm 0.1	60 \pm 1	6 \pm 0.5	6 \pm 0.5
88 \pm 1				
95 \pm 1				
102 \pm 1				
Mounting holes (M): M8x1.25, 9.5mm deep with SS helicoil				
Terminations: Copper finish Rz6.3				
Tightening torque: 15Nm Max				

HC5

High Power Resonant Capacitors

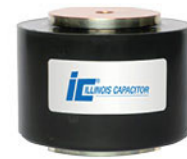

Frequency Derating

—●— Voltage —■— Current —▲— Power

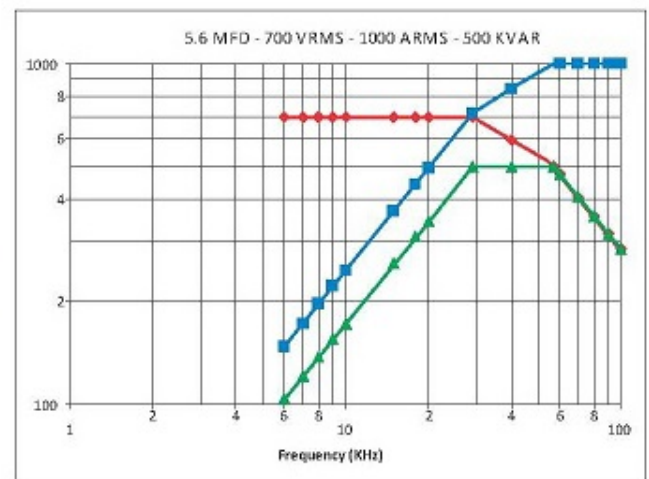
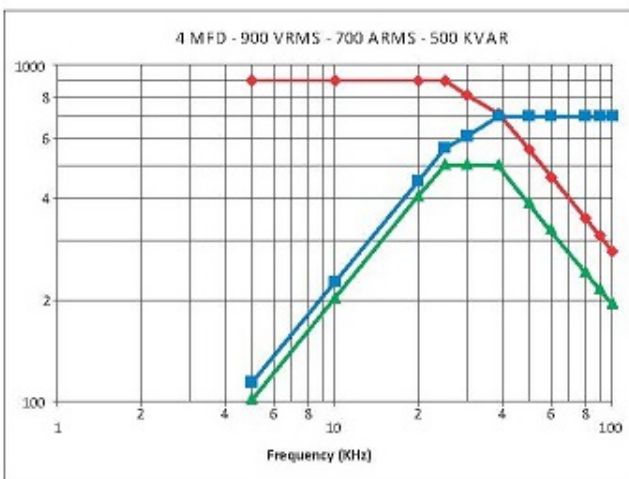
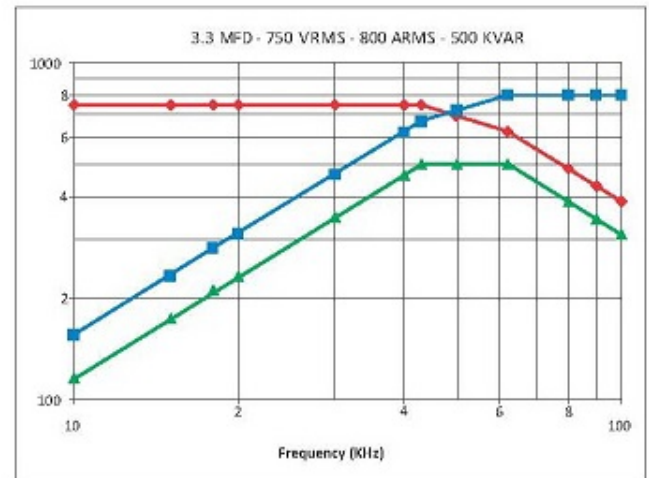
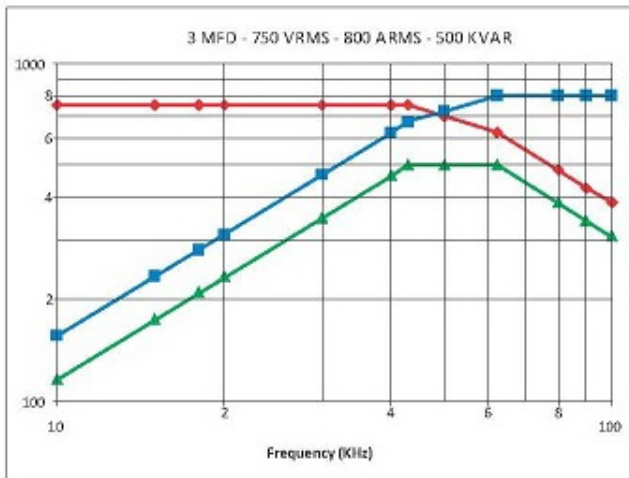
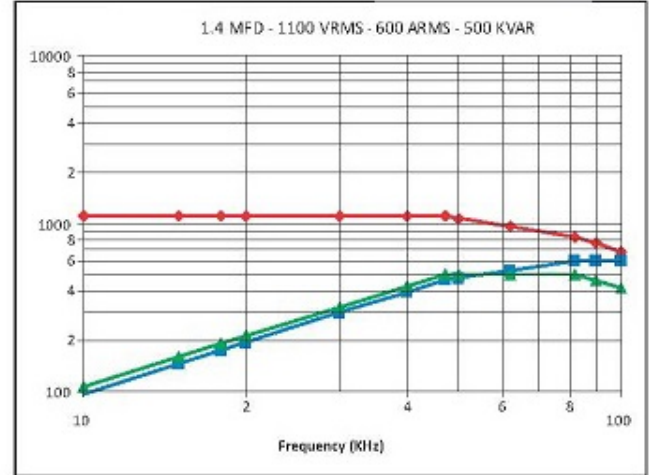
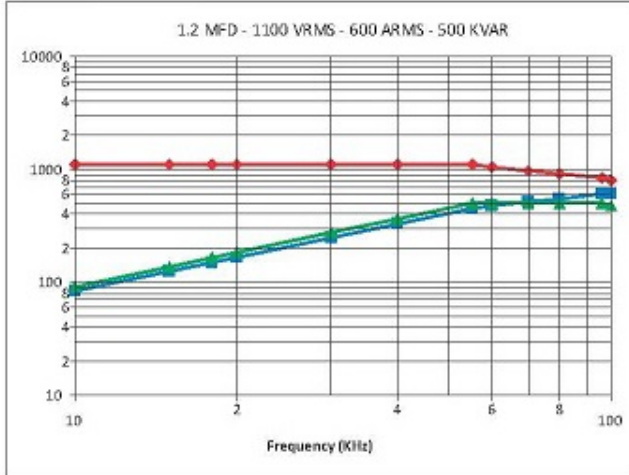

Your Global Source for World-Class Capacitors

© 2013 Illinois Capacitor, Inc.

North America
Tel: 847.675.1760
sales@illcap.com

Asia
Tel: 852.2793 0931
sales@illcap.com.hk

HC5

High Power Resonant Capacitors

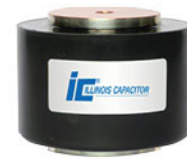

Frequency Derating

—●— Voltage —■— Current —▲— Power

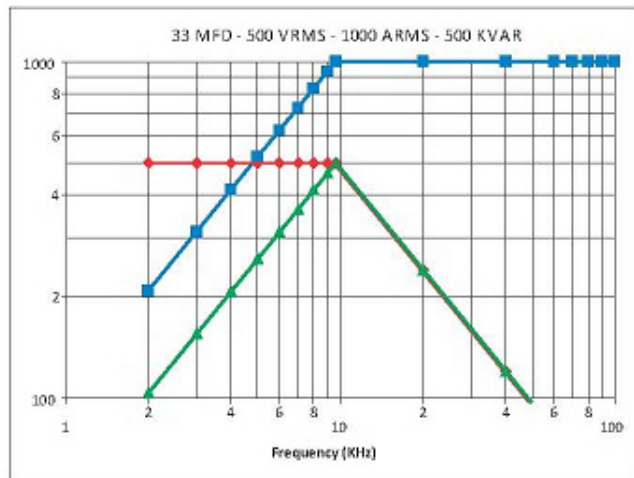
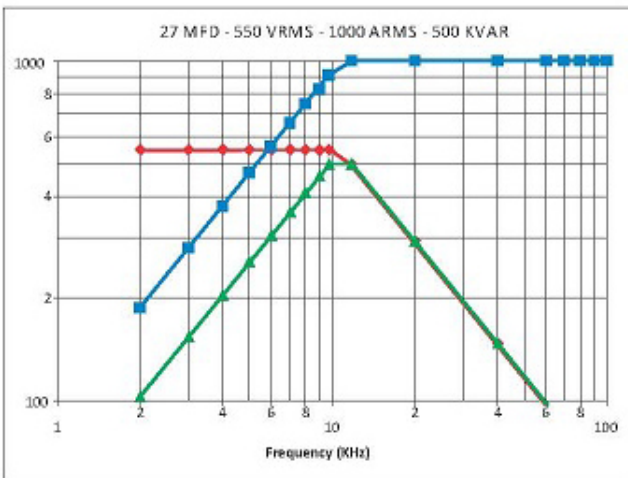
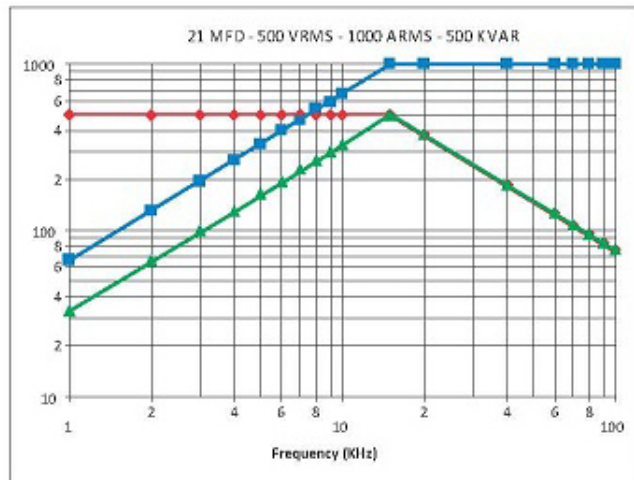
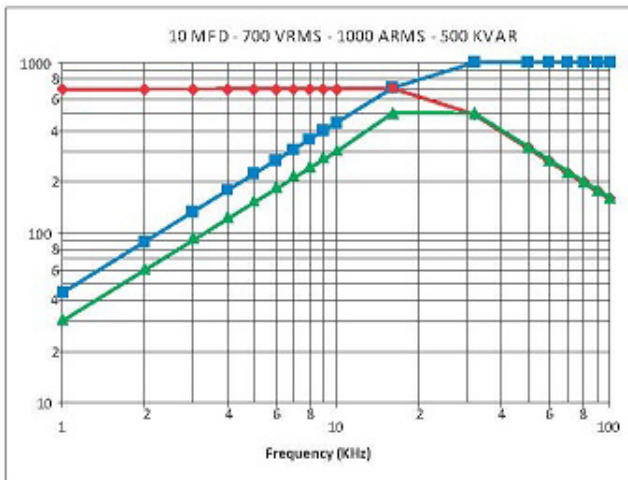
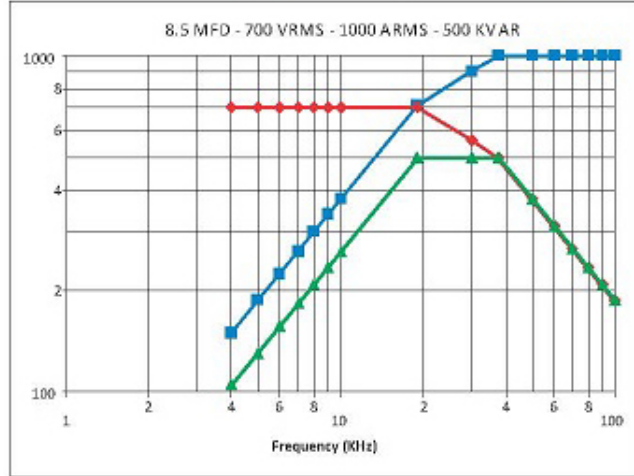
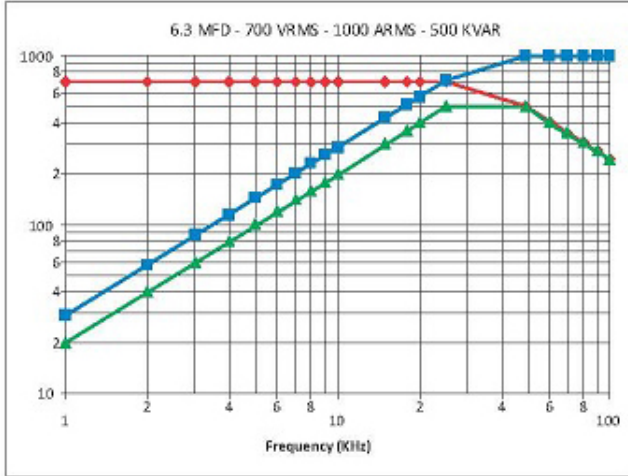

Your Global Source for World-Class Capacitors

© 2013 Illinois Capacitor, Inc.

North America
Tel: 847.675.1760
sales@illcap.com

Asia
Tel: 852.2793 0931
sales@illcap.com.hk

HC5

High Power Resonant Capacitors

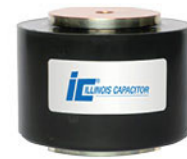

Frequency Derating

