

# Fast Recovery Epitaxial Diode (FRED)

## DSEI 2x61

$I_{FAVM} = 2x71 \text{ A}$   
 $V_{RRM} = 200 \text{ V}$   
 $t_{rr} = 35 \text{ ns}$

$V_{RSM}$ V	$V_{RRM}$ V	Type
200	200	DSEI 2x 61-02P

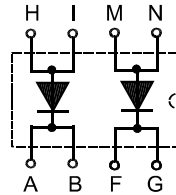

Symbol	Conditions	Maximum Ratings (per diode)	
$I_{FRMS}$	$T_{VJ} = T_{VJM}$	100	A
$I_{FAVM}$ ①	$T_C = 85^\circ\text{C}$ ; rectangular; $d = 0.5$	71	A
$I_{FRM}$	$t_p < 10 \mu\text{s}$ ; rep. rating; pulse width limited by $T_{VJM}$	800	A
$I_{FSM}$	$T_{VJ} = 45^\circ\text{C}$ ; $t = 10 \text{ ms}$ (50 Hz), sine	950	A
$T_{VJ}$		-40...+150	$^\circ\text{C}$
$T_{VJM}$		150	$^\circ\text{C}$
$T_{stg}$		-40...+150	$^\circ\text{C}$
$P_{tot}$	$T_C = 25^\circ\text{C}$	150	W
$V_{ISOL}$	50/60 Hz, RMS $I_{ISOL} \leq 1 \text{ mA}$	$t = 1 \text{ min}$ 2500 $t = 1 \text{ s}$ 3000	V~ V~
$M_d$	Mounting torque (M4)	1.5 - 2.0 14 - 18	Nm lb.in.
Weight		18	g

### Features

- 2 independent FRED in 1 package
- Isolation voltage 3000 V~
- Planar passivated chips
- Leads suitable for PC board soldering
- Very short recovery time
- Soft recovery behaviour

### Applications

- Antiparallel diode for high frequency switching devices
- Anti saturation diode
- Snubber diode
- Free wheeling diode in converters and motor control circuits
- Rectifiers in switch mode power supplies (SMPS)
- Inductive heating and melting
- Uninterruptible power supplies (UPS)
- Ultrasonic cleaners and welders

### Advantages

- Easy to mount with two screws
- Space and weight savings
- Improved temperature and power cycling capability
- Low noise switching
- Small and light weight

Symbol	Conditions	Characteristic Values (per diode)	
		typ.	max.
$I_R$	$T_{VJ} = 25^\circ\text{C}$ $V_R = V_{RRM}$		50 $\mu\text{A}$
	$T_{VJ} = 25^\circ\text{C}$ $V_R = 0.8 \cdot V_{RRM}$		40 $\mu\text{A}$
	$T_{VJ} = 125^\circ\text{C}$ $V_R = 0.8 \cdot V_{RRM}$		11 mA
$V_F$	$I_F = 60 \text{ A}$ ; $T_{VJ} = 150^\circ\text{C}$ $T_{VJ} = 25^\circ\text{C}$		0.88 V
			1.08 V
$V_{T0}$	For power-loss calculations only		0.7 V
$r_T$	$T_{VJ} = T_{VJM}$		3.0 m $\Omega$
$R_{thJC}$			0.8 K/W
$R_{thCK}$	0.05		K/W
$t_{rr}$	$I_F = 1 \text{ A}$ ; $-di/dt = 200 \text{ A}/\mu\text{s}$ $V_R = 30 \text{ V}$ ; $T_{VJ} = 25^\circ\text{C}$	35	50 ns
$I_{RM}$	$V_R = 100 \text{ V}$ ; $I_F = 60 \text{ A}$ ; $-di/dt = 200 \text{ A}/\mu\text{s}$ $T_{VJ} = 100^\circ\text{C}$	8	10 A
$d_S$	Creeping distance on surface	min. 11.2	mm
$d_A$	Creeping distance in air	min. 11.2	mm
$a$	Allowable acceleration	max. 50	m/s <sup>2</sup>

①  $I_{FAVM}$  rating includes reverse blocking losses at  $T_{VJM}$ ,  $V_R = 0.8 V_{RRM}$ , duty cycle  $d = 0.5$   
Data according to IEC 60747

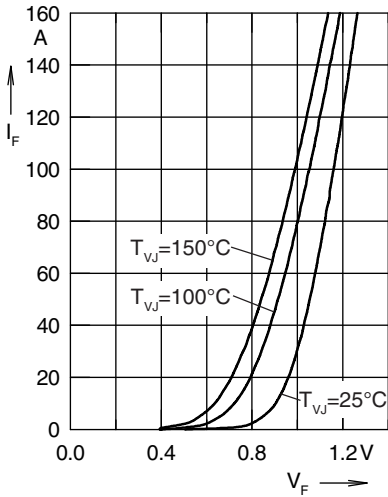

Fig. 1 Forward current  $I_F$  versus  $V_F$

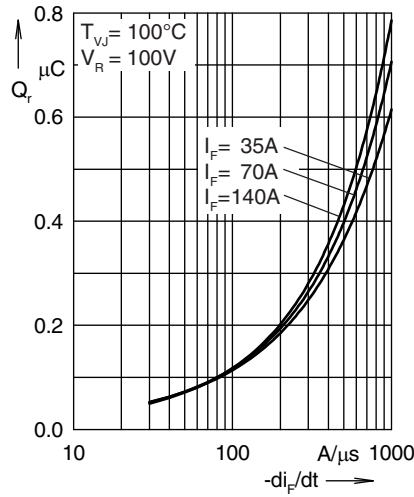

Fig. 2 Typ. reverse recovery charge  $Q_r$  versus  $-di_F/dt$

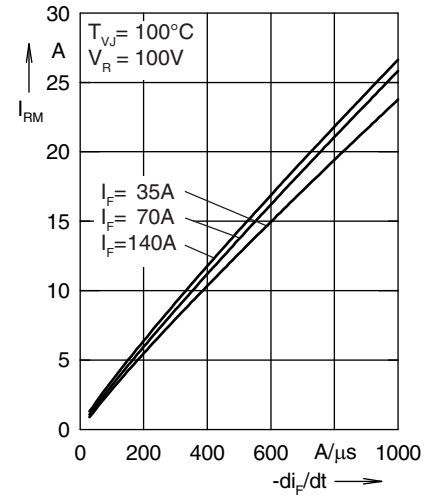

Fig. 3 Typ. peak reverse current  $I_{RM}$  versus  $-di_F/dt$

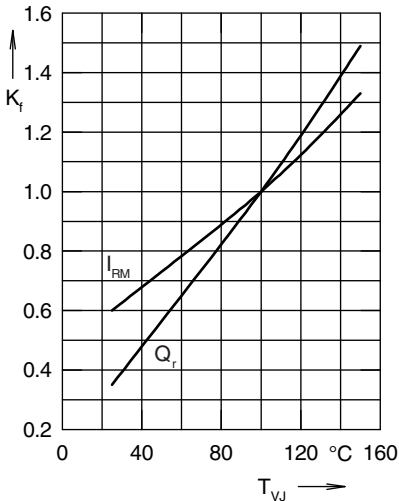

Fig. 4 Dynamic parameters  $Q_r$ ,  $I_{RM}$  versus  $T_{VJ}$

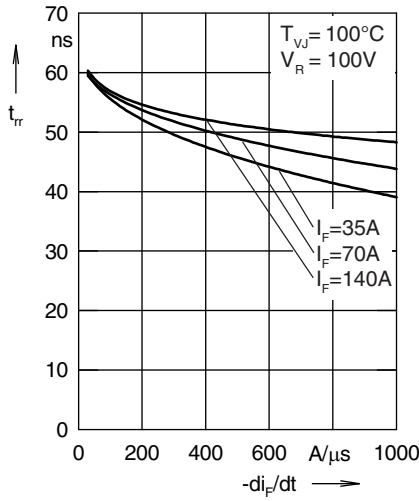

Fig. 5 Typ. recovery time  $t_{rr}$  versus  $-di_F/dt$

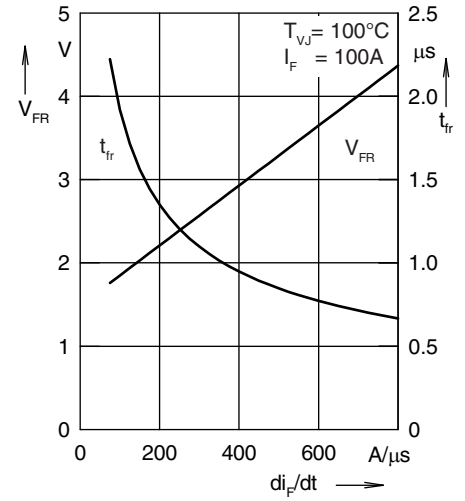

Fig. 6 Typ. peak forward voltage  $V_{FR}$  and  $t_{fr}$  versus  $di_F/dt$

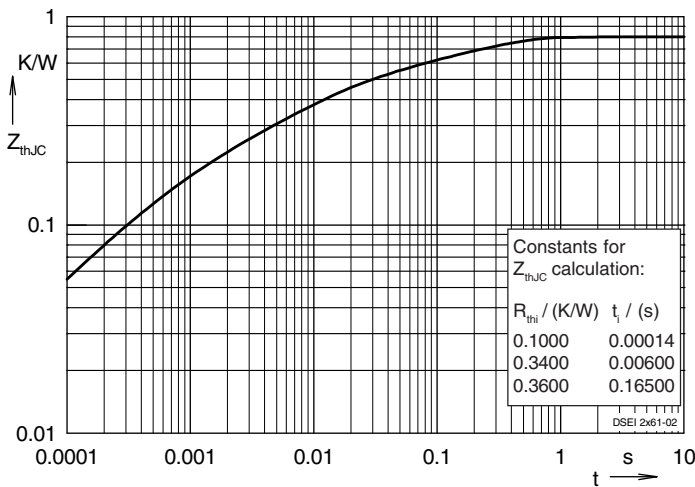
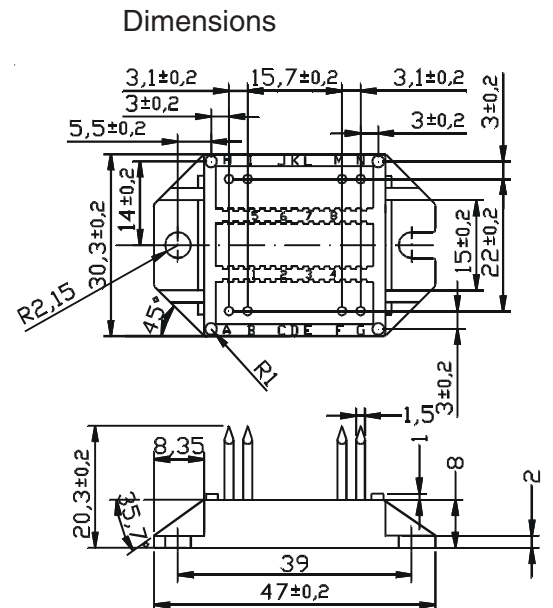

Fig. 7 Transient thermal impedance junction to case



20080125a