

TOUCH/LRACOMBOGEVB

TOUCH/LRACOMBOGEVB Evaluation Board User's Manual



ON Semiconductor®

<http://onsemi.com>

EVAL BOARD USER'S MANUAL

Scope

The TOUCH/LRACOMBOGEVB demo showcases ON Semiconductor's High-Accuracy Capacitive Touch Sensor (LC717A10AR) along with Linear Vibrator Driver (LC898301XA) for haptic feedback and an 8-bit Microcontroller (LC87F1M16A). The following is an instruction manual for the operation of this evaluation board.

Necessary Equipment

- 1 Mini-B USB Cable with PC (Figure 1) or
- 1 AC to DC 5 V USB Adapter (Figure 2)



Figure 1. Mini-B USB Cable



Figure 2. USB Adapter

Overview

Microcontroller (LC87F1M16A) distinguishes the keys of Touch Switch (LC717A10AR) by using I²C and control the actuator of Haptics (LC898301XA), LED and speaker.

The power supply is supplied from USB.

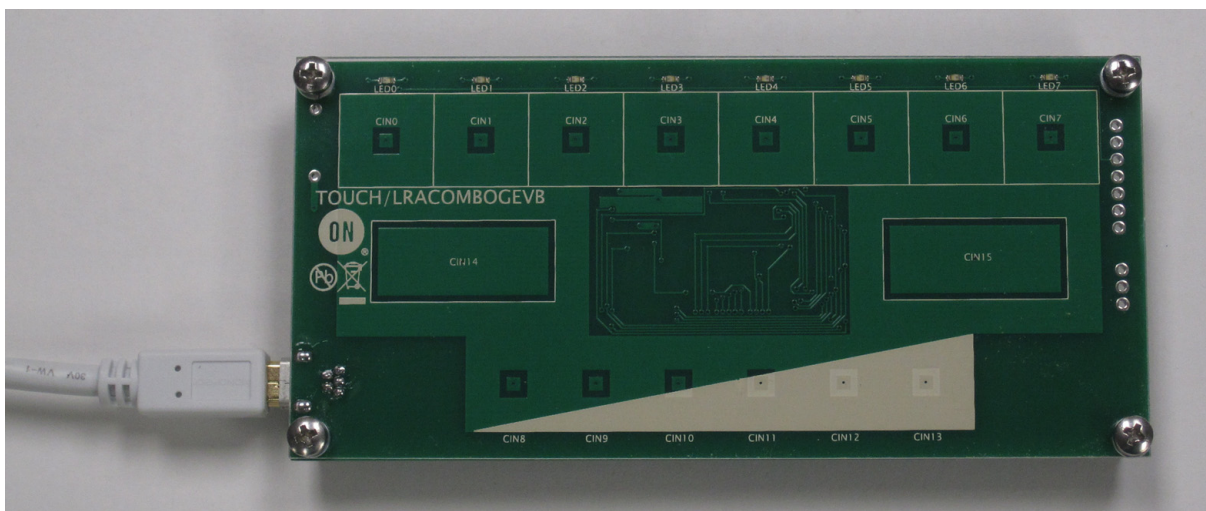

Figure 3. Board with USB Cable

TOUCH/LRACOMBOGEVB

BLOCK DIAGRAM

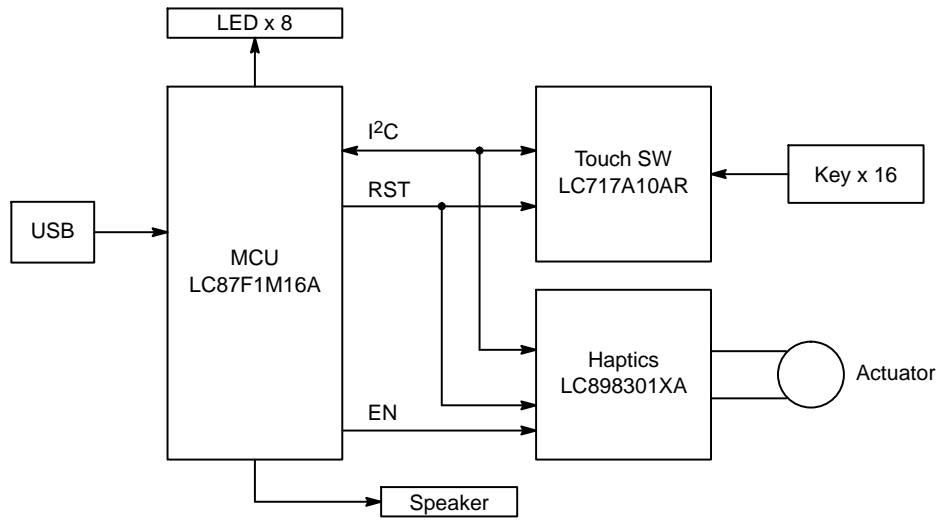
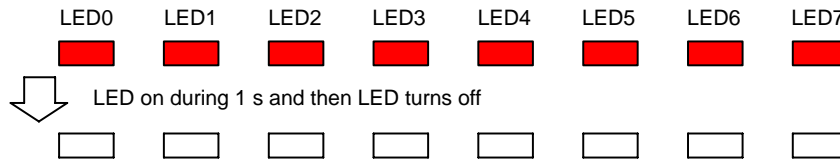

Figure 4. Block Diagram

TOUCH KEY FUNCTIONS

Connect USB Cable

LED turns on for one second when 5 V is applied to VDD.



LED blinks three times when USB is connected if the USB driver is available. (USB driver is optional. It is necessary when updating the firmware.)

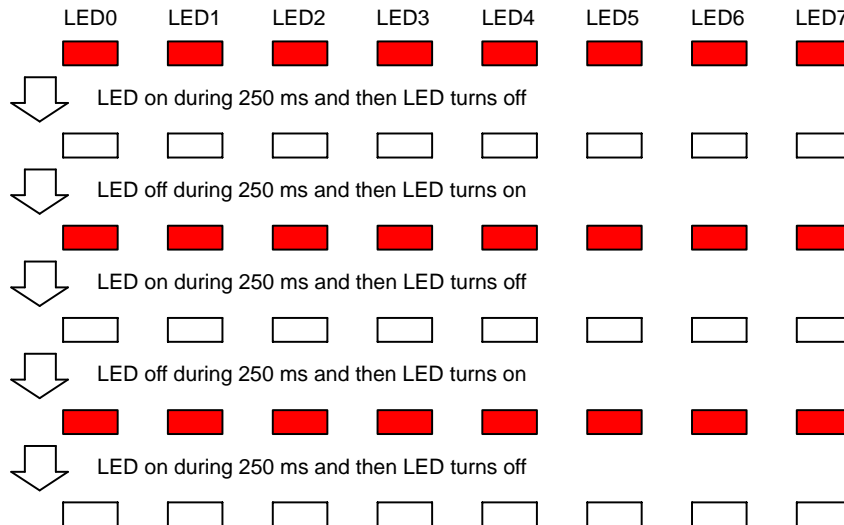

TOUCH/LRACOMBOGEVB

Key Layout

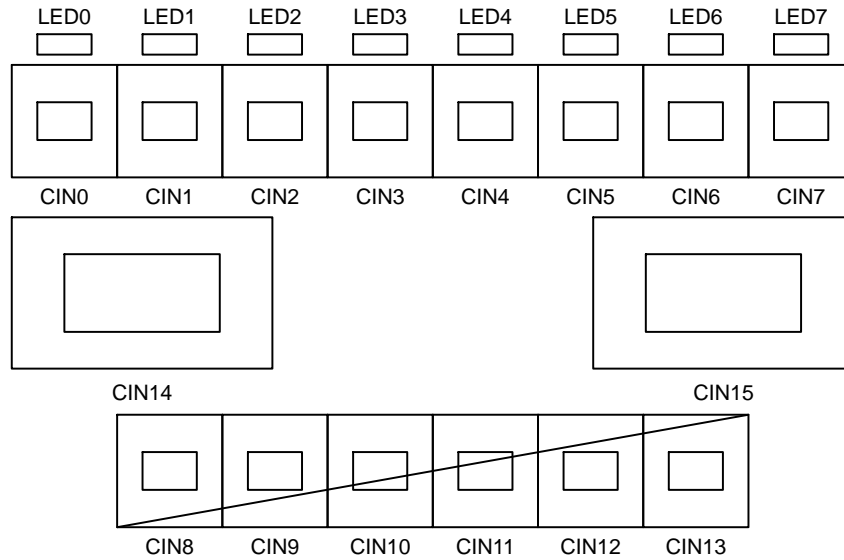

Normal Key Action

When key is touched upper LED of each key turns ON.
e.g. CIN0 is touched LED0 turns ON.

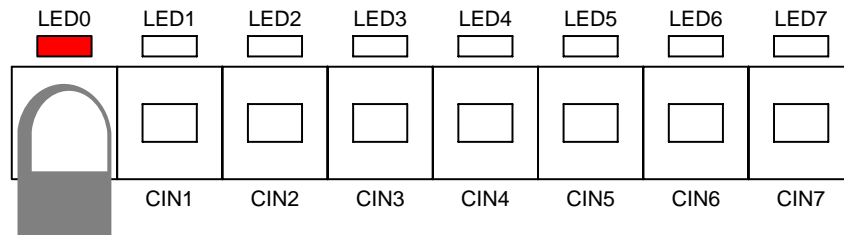

When multiple keys are touched.

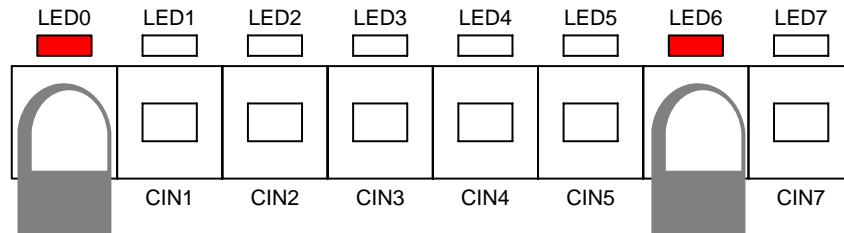

When key is touched, speaker plays respected musical scale. CIN0 is “Do”, CIN1 is “Re”...CIN6 is “Si”, and CIN7 is upper “Do”.

TOUCH/LRACOMBOGEVB

Slide Key Action

These slide keys can change the sensitivity (AMP gain and threshold level) of the Proximity Keys (CIN14, CIN15).

The slide keys have 11 kinds of sensitivity levels. When touch the slide key, the LED of each level is ON. e.g. Level 3

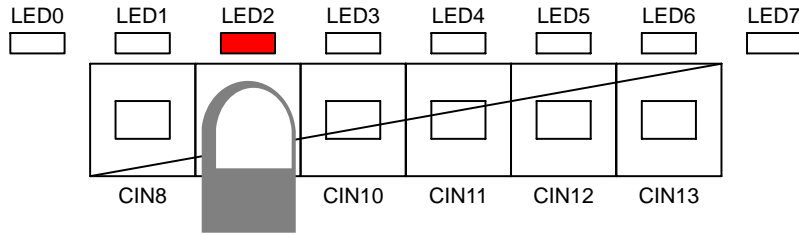

move right on the Touch key,

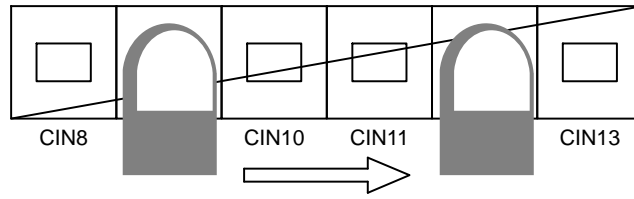

to increase the sensitivity level.

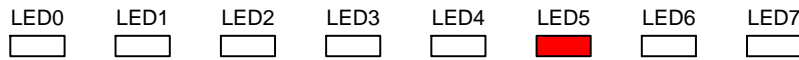

move left on the Touch key,

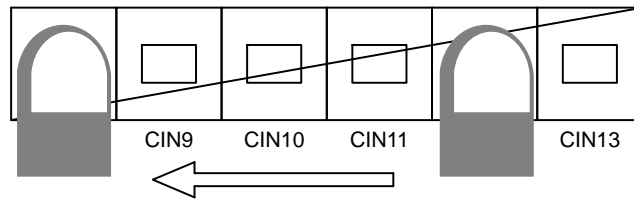

to decrease the sensitivity level.

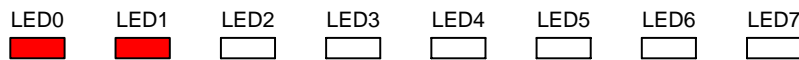

TOUCH/LRACOMBOGEVB

Correspondence of the sensitivity levels of LED and touch key.

Level	LED0	LED1	LED2	LED3	LED4	LED5	LED6	LED7	Touch Key
1									CIN8
2									CIN8 and CIN9
3									CIN9
4									CIN9 and CIN10
5									CIN10
6									CIN10 and CIN11
7									CIN11
8									CIN11 and CIN12
9									CIN12
10									CIN12 and CIN13
11									CIN13

Proximity Key Action

These proximity keys react without touch. Bleep sounds when keys are approached. When close to CIN14 LEDs on left side turn ON.

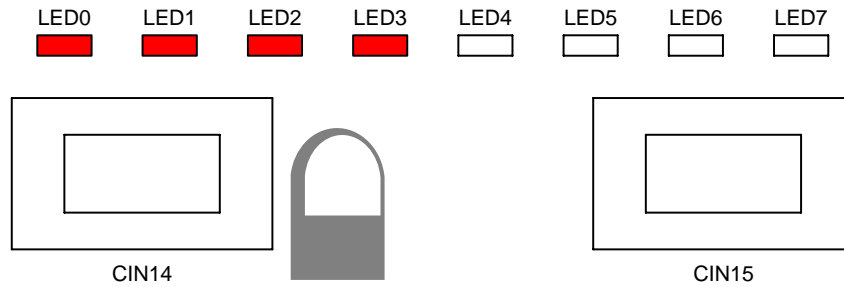

When close to CIN15 LEDs on right side turn ON.

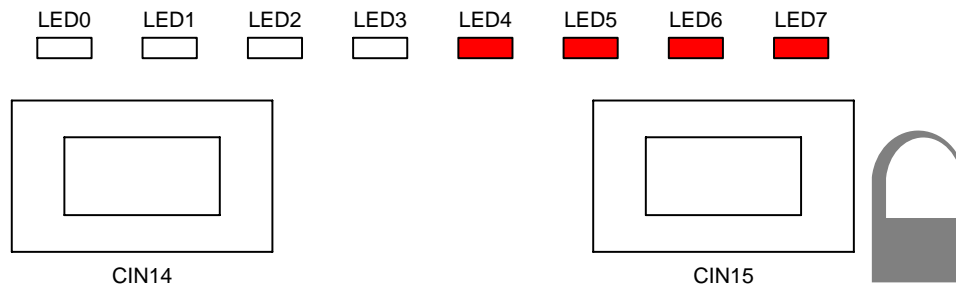

TOUCH/LRACOMBOGEVB

HAPTIC FUNCTIONS

When any key is touched, Linear Resonant Actuator (LRA) vibrates. There are several types of vibrations.

Vibration level changes depending on touch key of CIN0 to CIN7.

Vibration Level

When any key is touched, Linear Resonant Actuator (LRA) vibrates.

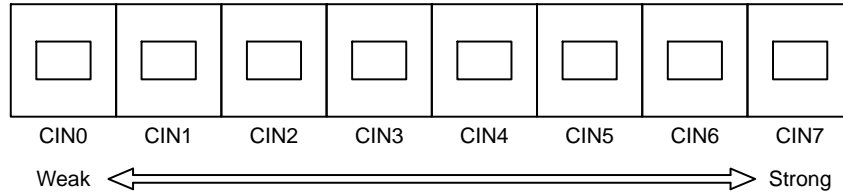

Change Resonance Frequency

Our Haptics IC can use 32 pattern of resonance frequency for LRA. This evaluation board uses two patterns 175 Hz and 205 Hz. (default is 205 Hz)

When touching both CIN7 and CIN13, current resonance frequency is displayed. e.g. Current frequency is 205 Hz. (setting data is "0Bh")

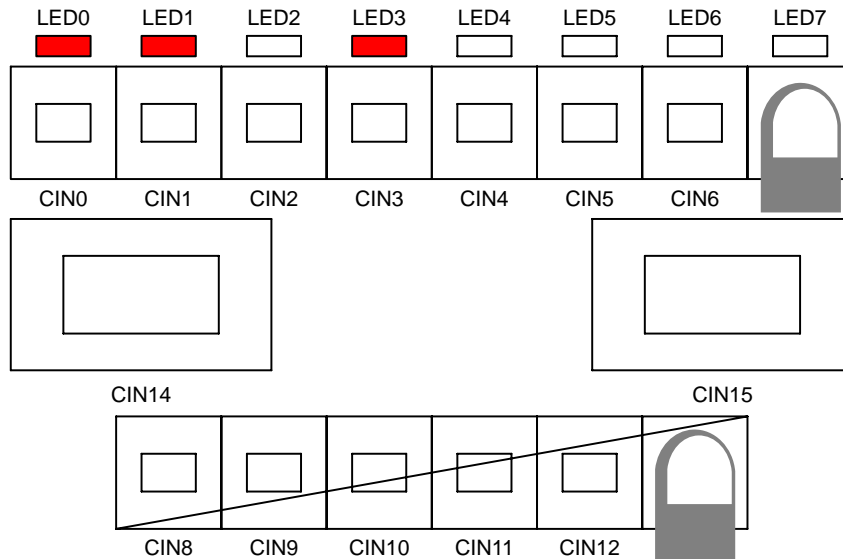

Hold keys during 5 seconds, then resonance frequency will change. Bleep noise will sound at the same time.

If current resonance frequency is 205 Hz, then resonance frequency will change to 175 Hz.

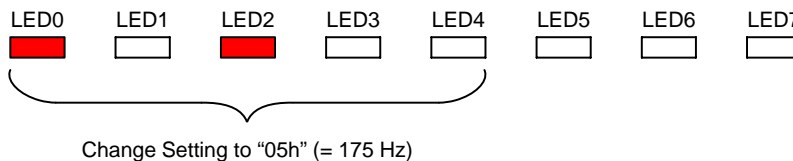

If current resonance frequency is 175 Hz, then resonance frequency will change to 205 Hz.

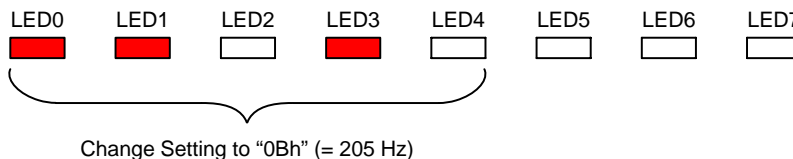

TOUCH/LRACOMBOGEVB

OTHER FUNCTIONS

Touch ON Automatic Cancellation

LC717A10AR does not have Touch ON automatic cancellation function. So, the software implements the auto touch-off function for a fail-safe. Auto off time is about 8 seconds.

Reset Switches

If you observe the board is not a normal condition, push the Reset Switch (SW2) of the backside.

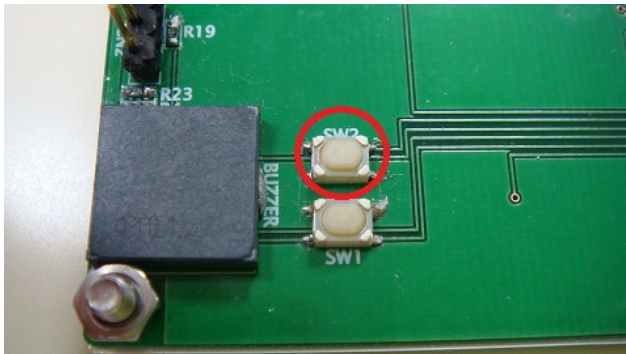

Figure 5. Reset Switch of MCU

SW1 is reset switch for LC717A10AR and LC898301XA. However MCU resets these ICs during the initialization process when MCU program starts up. So, normally SW1 is not used.

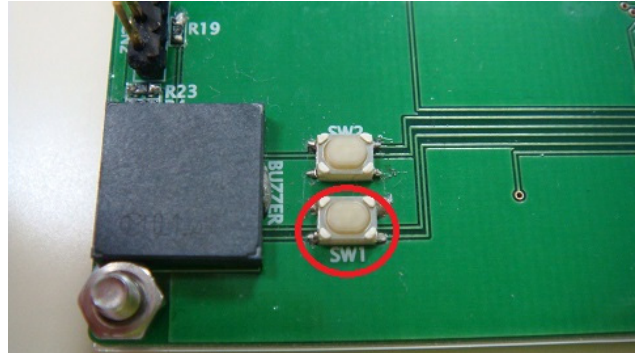

Figure 6. Reset Switch of LC717A10AR and LC898301XA

RELATED DOCUMENTS

Supporting materials such as: Datasheets, Application Notes, Evaluation Kits/Boards, Evaluation Board Documents and Software are available for all three featured ON Semiconductor components. To obtain the most updated

documentation please visit the ON Semiconductor Web site at www.onsemi.com and search part numbers: LC717A10AR (Touch Sensor), LC898301XA (Linear Vibrator Driver), and LC87F1M16A (Microcontroller).

ON SEMICONDUCTOR IC LINKS

- LC717A10AR: <http://onsemi.com/PowerSolutions/product.do?id=LC717A10AR>
- LC898301XA: <http://onsemi.com/PowerSolutions/product.do?id=LC898301XA>
- LC87F1M16A: <http://onsemi.com/PowerSolutions/product.do?id=LC87F1M16A>

ON Semiconductor and the  are registered trademarks of Semiconductor Components Industries, LLC (SCILLC) or its subsidiaries in the United States and/or other countries. SCILLC owns the rights to a number of patents, trademarks, copyrights, trade secrets, and other intellectual property. A listing of SCILLC's product/patent coverage may be accessed at www.onsemi.com/site/pdf/Patent-Marketing.pdf. SCILLC reserves the right to make changes without further notice to any products herein. SCILLC makes no warranty, representation or guarantee regarding the suitability of its products for any particular purpose, nor does SCILLC assume any liability arising out of the application or use of any product or circuit, and specifically disclaims any and all liability, including without limitation special, consequential or incidental damages. "Typical" parameters which may be provided in SCILLC data sheets and/or specifications can and do vary in different applications and actual performance may vary over time. All operating parameters, including "Typicals" must be validated for each customer application by customer's technical experts. SCILLC does not convey any license under its patent rights nor the rights of others. SCILLC products are not designed, intended, or authorized for use as components in systems intended for surgical implant into the body, or other applications intended to support or sustain life, or for any other application in which the failure of the SCILLC product could create a situation where personal injury or death may occur. Should Buyer purchase or use SCILLC products for any such unintended or unauthorized application, Buyer shall indemnify and hold SCILLC and its officers, employees, subsidiaries, affiliates, and distributors harmless against all claims, costs, damages, and expenses, and reasonable attorney fees arising out of, directly or indirectly, any claim of personal injury or death associated with such unintended or unauthorized use, even if such claim alleges that SCILLC was negligent regarding the design or manufacture of the part. SCILLC is an Equal Opportunity/Affirmative Action Employer. This literature is subject to all applicable copyright laws and is not for resale in any manner.

PUBLICATION ORDERING INFORMATION

LITERATURE FULFILLMENT:
Literature Distribution Center for ON Semiconductor
P.O. Box 5163, Denver, Colorado 80217 USA
Phone: 303-675-2175 or 800-344-3860 Toll Free USA/Canada
Fax: 303-675-2176 or 800-344-3867 Toll Free USA/Canada
Email: orderlit@onsemi.com

N. American Technical Support: 800-282-9855 Toll Free
USA/Canada
Europe, Middle East and Africa Technical Support:
Phone: 421 33 790 2910
Japan Customer Focus Center
Phone: 81-3-5817-1050

ON Semiconductor Website: www.onsemi.com
Order Literature: <http://www.onsemi.com/orderlit>
For additional information, please contact your local Sales Representative