

LISA2-W-CLIP

~35° wide beam optimized for CREE XP-E. 6.8 mm high variant with clip installation.

TECHNICAL SPECIFICATIONS:

Dimensions	Ø 9.9 mm
Height	6.8 mm
Fastening	glue, clips
Colour	black
Box size	310 x 230 x 60 mm
Box weight	1.4 kg
Quantity in Box	2000 pcs
ROHS compliant	yes ⓘ



MATERIAL SPECIFICATIONS:

Component	Type	Material	Colour
LISA2-W	Lens	PMMA	clear
LISA2-HLD-CLIP16-XP	Holder	PC	black

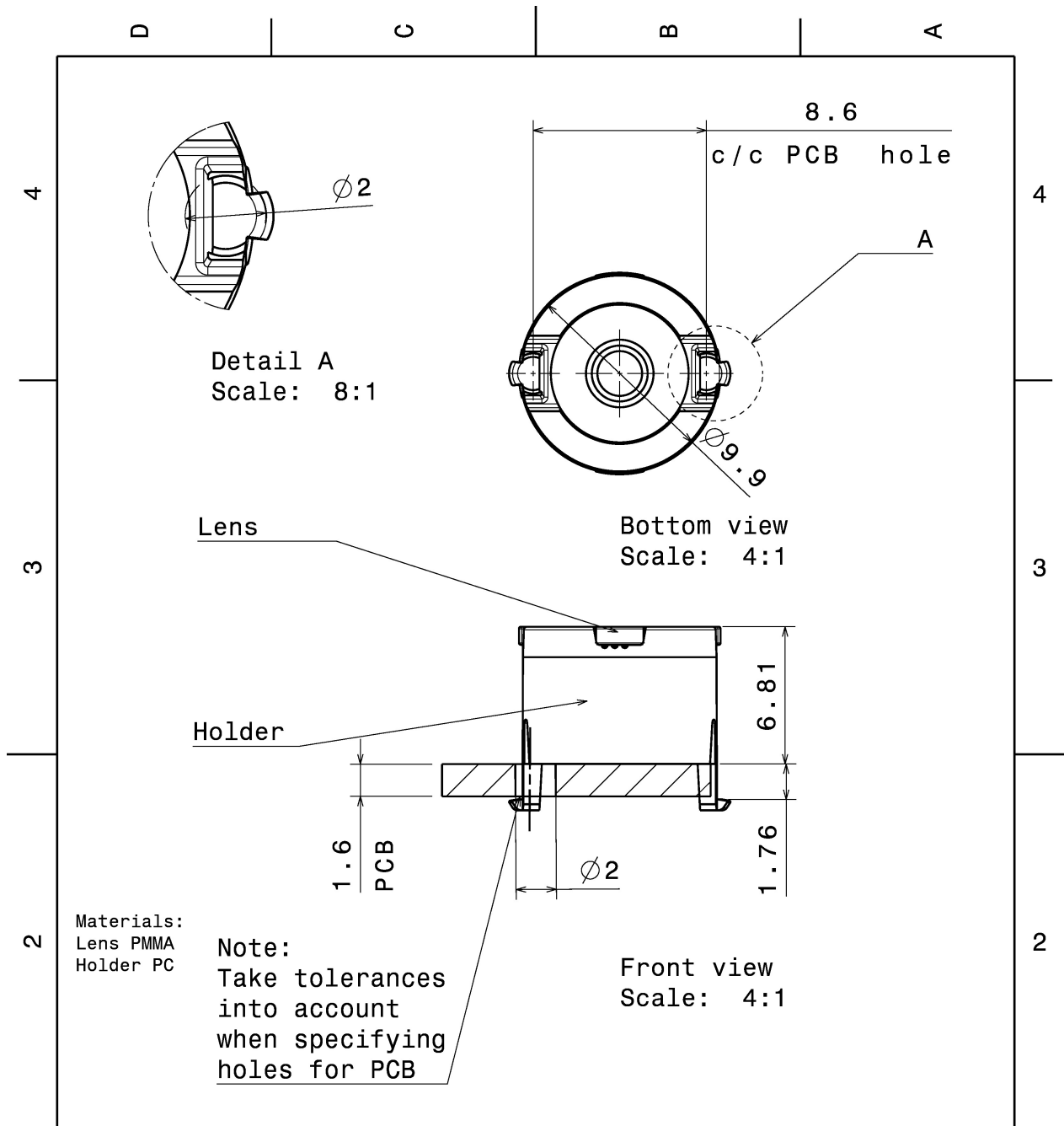

Tolerances if not otherwise shown
According to DIN ISO 2768-1
Linear measures:
up to 30mm class M, otherwise class C
According to DIN ISO 2768-2
Form and position: class L

LEDiL LediL Oy
Salorankatu 10
FIN 24240 SALO
Finland

THIRD ANGLE PROJECTION:

DRAWING TITLE
Datasheet Lisa2-clip16-XT series Assy

This drawing is the property of LEDiL Oy. It may not be reproduced, copied or communicated without a written agreement with LEDiL Oy.

SIZE	PART NUMBER
A4	

SCALE	4:1	WEIGHT	-	SHEET	1/1
-------	-----	--------	---	-------	-----

PHOTOMETRIC DATA (MEASURED):



LED XP-G2
 FWHM 36.0°
 Efficiency 88 %
 Peak intensity 2.200 cd/lm
 Required components:

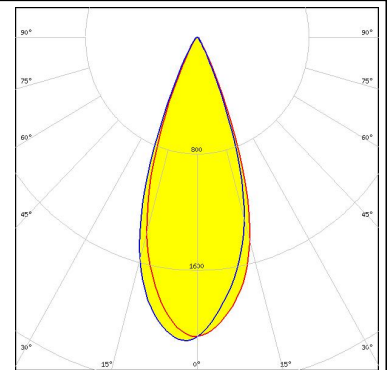

LED XP-G3
 FWHM 41.0°
 Efficiency 85 %
 Peak intensity 1.680 cd/lm
 Required components:

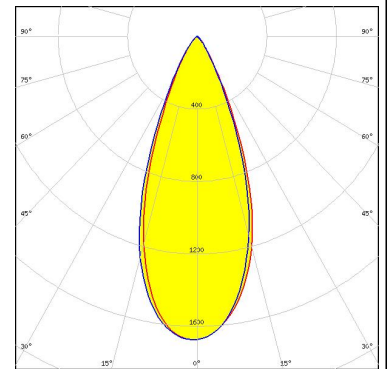
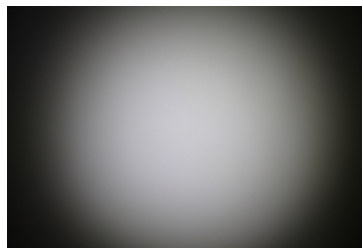

LED XT-E
 FWHM 32.0°
 Efficiency 84 %
 Peak intensity 2.200 cd/lm
 Required components:

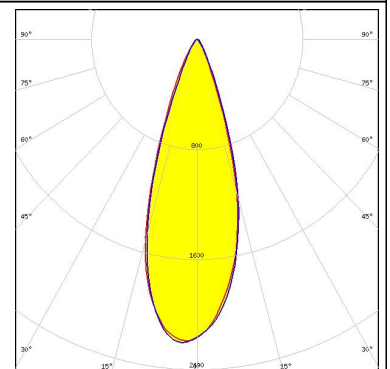

LED H35C1 (LEMWA33)
 FWHM 40.0°
 Efficiency 88 %
 Peak intensity 2.000 cd/lm
 Required components:

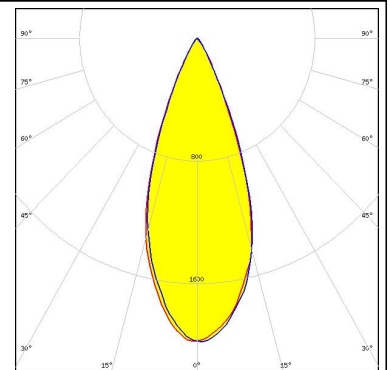
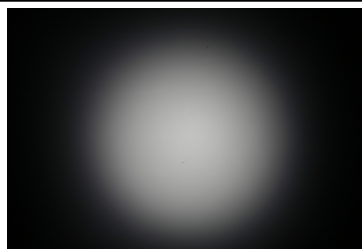

PHOTOMETRIC DATA (MEASURED):

LUMILEDS

LED LUXEON T
 FWHM 36.0°
 Efficiency 86 %
 Peak intensity 2.000 cd/lm
 Required components:

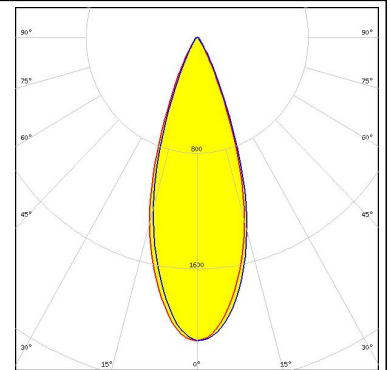

LUMILEDS

LED LUXEON TX
 FWHM 34.0°
 Efficiency 88 %
 Peak intensity 2.500 cd/lm
 Required components:

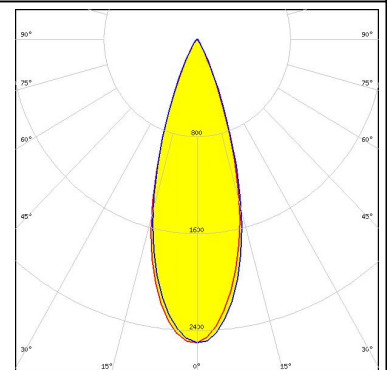
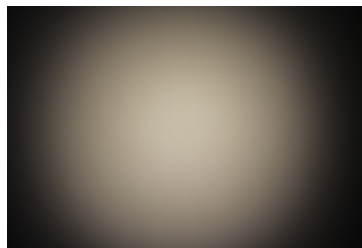

NICHIA

LED NCSxx19B
 FWHM 34.0°
 Efficiency 84 %
 Peak intensity 2.600 cd/lm
 Required components:

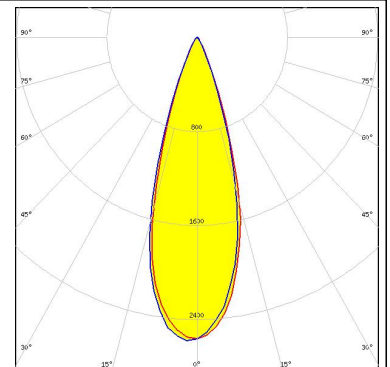

NICHIA

LED NVSxx19B/NVSxx19C
 FWHM 38.0°
 Efficiency 87 %
 Peak intensity 1.900 cd/lm
 Required components:

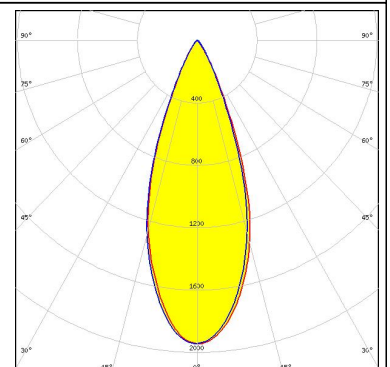
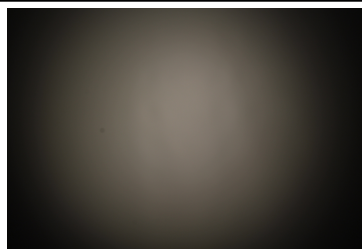

PHOTOMETRIC DATA (MEASURED):

OSRAM
Opto Semiconductors

LED Oslon Square EC
FWHM 33.0°
Efficiency 85 %
Peak intensity 2.400 cd/lm
Required components:

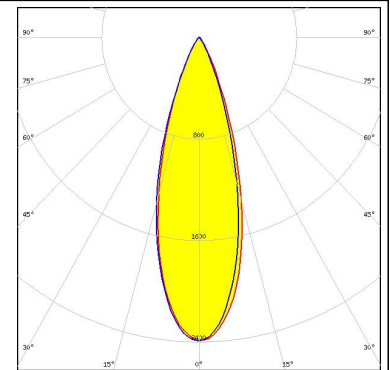
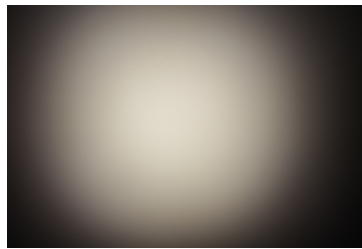

OSRAM
Opto Semiconductors

LED SFH 4715S
FWHM 22.0°
Efficiency %
Peak intensity cd/lm
Required components:

OSRAM
Opto Semiconductors

LED SFH 4725S
FWHM 24.0°
Efficiency %
Peak intensity cd/lm
Required components:

SAMSUNG

LED LH351B
FWHM 40.0°
Efficiency 88 %
Peak intensity 1.920 cd/lm
Required components:

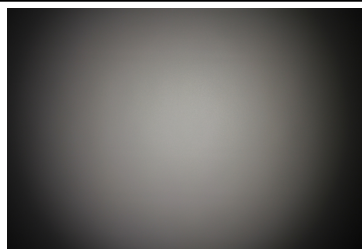

PHOTOMETRIC DATA (MEASURED):

SAMSUNG

LED LH351Z
FWHM 38.0°
Efficiency 88 %
Peak intensity 2.100 cd/lm
Required components:

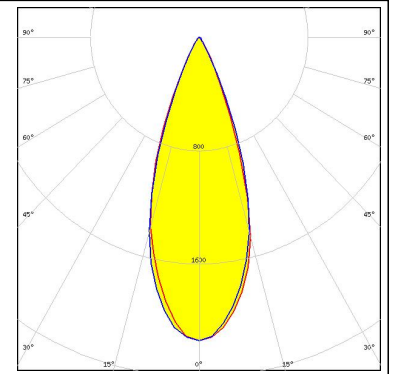
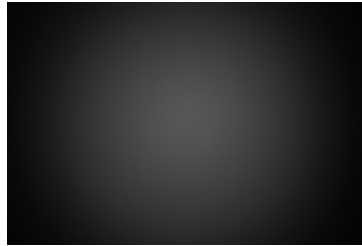

PHOTOMETRIC DATA (SIMULATED):



LED LUXEON H50-2
FWHM 30.0°
Efficiency 89 %
Peak intensity 2.800 cd/lm
Required components:

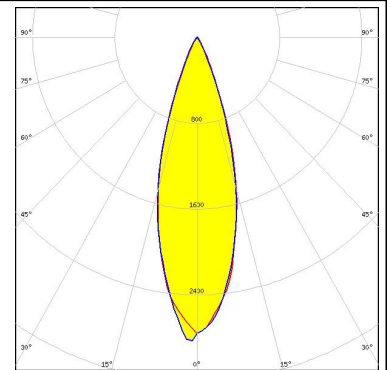

LED LUXEON IR Compact
FWHM 34.0°
Efficiency 83 %
Peak intensity 0.000 cd/lm
Required components:



SEOUL SEMICONDUCTOR

LED Z8Y22P
FWHM 38.0°
Efficiency 84 %
Peak intensity 1.590 cd/lm
Required components:

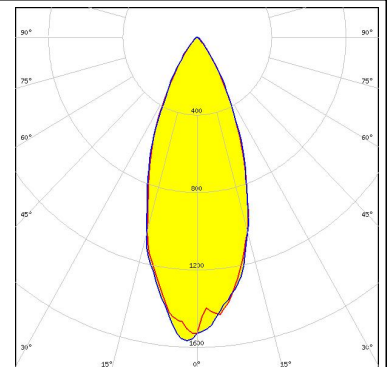

GENERAL INFORMATION:

NOTE: The typical beam angle will be changed by different color, chip size and chip position tolerance. The typical total beam angle is the full angle measured where the luminous intensity is half of the peak value.

MATERIALS:

As part of our continuous research and improvement processes, and to ensure the best possible quality and availability of our products, LEDiL reserves the right to change material grades without notice.

PRODUCT DATA USER AGREEMENT AND DISCLAIMER:

The measured data in the provided downloadable LEDiL Product Datasheets and Mechanical 2D-Drawings is rounded and provided as reference for planning. LEDiL Oy's optical specifications have been verified by conducting performance testing of the products in accordance with the company's quality system. The reported data are averaged results of multiple measurements with typical variation. LEDiL Oy reserves the right to without prior notification make changes and improvements to its products.

LEDiL Oy assumes neither warranty, nor guarantee nor any other liability of any kind for the contents and correctness of the provided data. The provided data has been generated with highest diligence but the provided data may in reality not represent the complete possible variation range of all intrinsic parameters. Therefore, in certain cases a deviation from the provided data could occur.

LEDiL Oy reserves the right to undertake technical changes of its products without further notification which could lead to changes in the provided data. LEDiL Oy assumes no liability of any kind for the possible deviation from any provided data or any other damage resulting from the usage of the provided data.

The user agrees to this disclaimer and user agreement with the download or usage of the provided files.

LEDiL Oy

Joensuunkatu 13
FI-24240 SALO
Finland

LEDiL Inc.

228 West Page Street
Suite D
Sycamore IL 60178
USA

Local sales and technical support

[www.ledil.com/
where_to_buy](http://www.ledil.com/where_to_buy)

Shipping locations

Salo, Finland
Hong Kong, China

Distribution Partners

[www.ledil.com/
where_to_buy](http://www.ledil.com/where_to_buy)