



BOARD LEVEL COOLING – Channel 5900

Channel 5900 is a series of channel board level heat sinks designed to cool TO-220 and TO-220-single gauge devices. Representative image only.

ORDERING INFORMATION

Part Number	Device Type
592902B03400G	TO-220, TO-220-single gauge
593002B00000G	TO-220, TO-220-single gauge
593002B03400G	TO-220, TO-220-single gauge

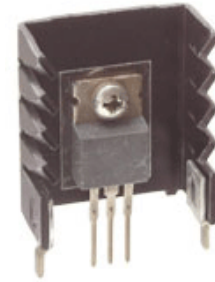

HEAT SINK DETAILS

Property	Details
Material	Aluminum
Finish	Black Anodize
Device Attachment Options	Requires Mounting Kit
Thermal Interface Material	-

Property	Details
Heat Sink Width (mm)	25.40
Heat Sink Length (mm)	12.70
Heat Sink Height (mm)	See "A" Dim below
Heat Sink Mounting Direction	Vertical

MECHANICAL & PERFORMANCE

Drawing dimensions are shown in mm, (in)

Part Number	"A" Dim	"X" Dim	"Y" Dim	"Z" Dim
592902B03400G	24.98	8.89 (0.350)	0.74 (0.029)	2.39 (0.094)
593002B00000G	29.98	8.89 (0.350)	0.74 (0.029)	2.39 (0.094)
593002B03400G	29.97	11.18 (0.440)	8.26 (0.325)	2.39 (0.094)

Part Number: 593002B00000G

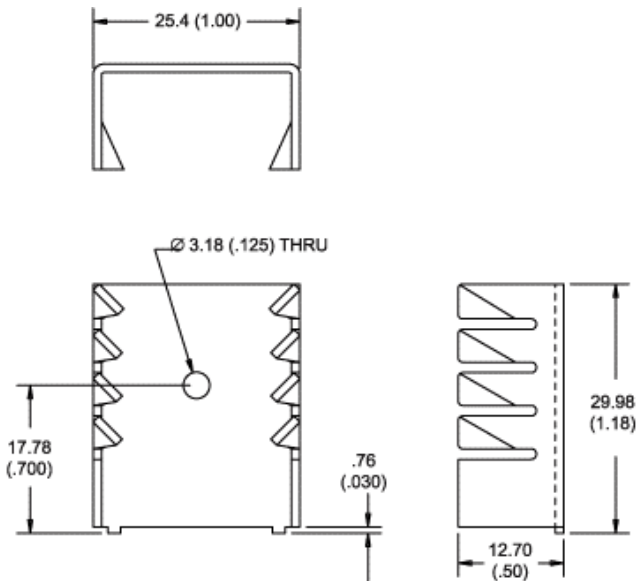

Mounting Details:

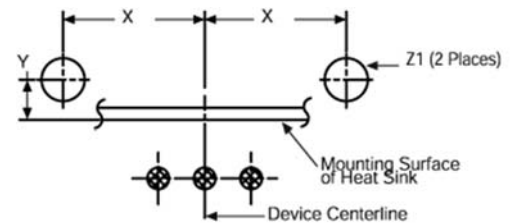

Part Numbers: 592902B03400G, 593002B03400G

Mounting Details:

