

High Speed Fuses

Section Contents

	Page
General Applications	94-95
North American fuses & accessories	94-113
DFJ - High speed Class J fuse	97
Square Body fuses & accessories	114-176
BS 88 fuses & accessories	177-185
Ferrule fuses & accessories.	186-206



General Applications

Rated Voltage

The AC voltage rating of Cooper Bussmann® fuses is given in volts rms. Fuses tested to IEC are tested at 5% above their rated voltage. British Style BS 88 fuses are tested at 10% above its rated voltage. UL recognition tests are performed at the rated voltage.

Rated Current

Rated current is given in amps rms. Cooper Bussmann fuses can continuously carry the rated current.

Melting Characteristic

The melting characteristic shows the virtual melting time in seconds as a function of the prospective current in amperes rms. The fuses are specially constructed for short-circuit protection against high level fault currents. Loading and operation of the fuse in the non-continuous/dashed section of the melt curve must be avoided. The curve can also be read as the real melting time as a function of the RMS value of the pre-arc current.

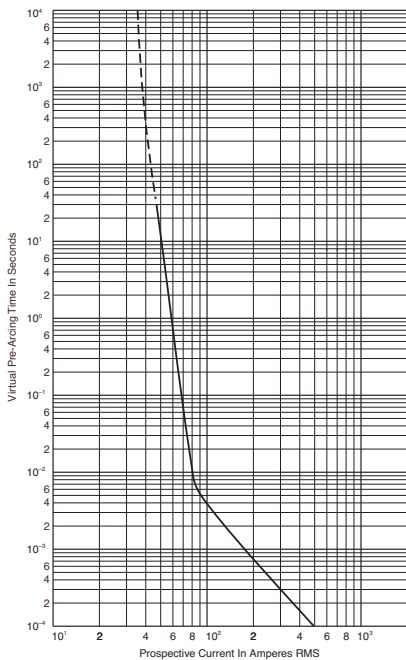

Clearing Integrals

The total clearing I^2t at rated voltage and at power factor of 15% are given in the electrical characteristics. For other voltages, the clearing I^2t is found by multiplying by correction factor, K, given as a function of applied working voltage, E_g , (rms).

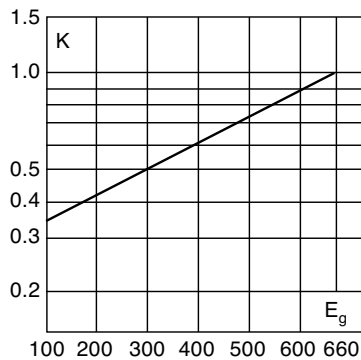

Power Factor

For other power factor values, the total clearing integral can be calculated as a multiple of the clearing integrals, the correction factor K and the correction factor X.

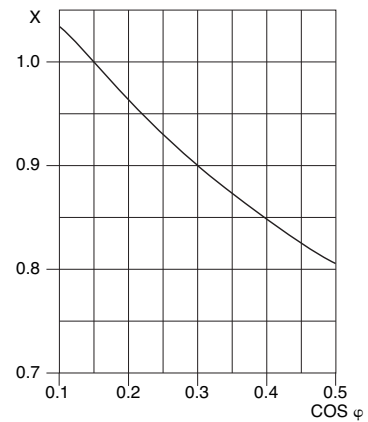

Arc Voltage

This curve gives the peak arc voltage, U_L , which may appear across the fuse during its operation as a function of the applied working voltage, E_g , (rms) at a power factor of 15%.

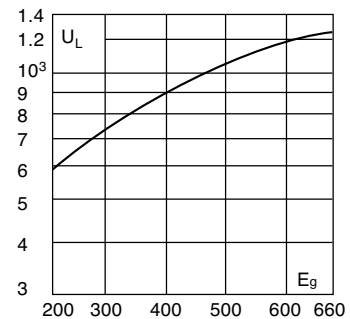

Power Losses

Watts loss at rated current is given in the electrical characteristics. The curve allows the calculation of the power losses at load currents lower than the rated current. The correction factor, K_p , is given as a function of the RMS load current, I_b , in % of the rated current.

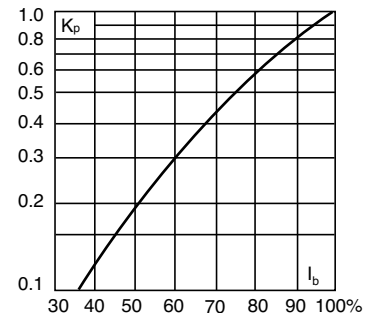

Cut-Off Current

A fuse operation relating to short-circuits only. When a fuse operates in its current-limiting range, it will clear a short-circuit in less than 1/2 cycle. Also, it will limit the instantaneous

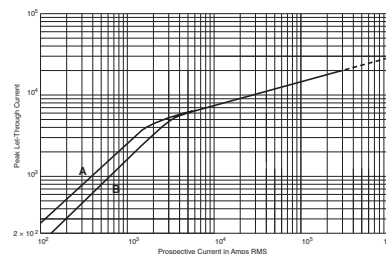

peak let-through current to a value substantially less than that obtainable in the same circuit if that fuse were replaced

General Applications

with a solid conductor of equal impedance.

- A asymmetrical current
- B symmetrical current

Parallel Connection

When fuses are connected in parallel it is recommended that the applied voltage does not exceed $0.9 U_N$ (the rated voltage of the fuse). This is due to the fact that the energy released within the fuses may be unevenly shared between the parallel connected barrels.

When fuses are connected in parallel, one must take into account that the current sharing is not necessarily equal. And it must be checked, that the maximum load current is not exceeded.

Series Connection

Fuses in series may not equally divide the applied voltage. It is recommended that series connected fuses should only be operated at fault currents that yield melting times less than 10 ms and a recovery voltage per fuse of less than or equal to $0.9 U_N$ (the rated voltage of the fuse).

Mounting Guidance

The recommendations below have to be followed when mounting a Cooper Bussmann fuse with end plate threaded holes.

1. Screw in studs: 5 N•m Max, 3 N•m Min
2. Attachment of the fuse to bussbar by means of nut and washer:

Thread Configuration	Torque (N•m)*	
	Max	Min
5/16" - 18, M8	25	20
3/8" - 16, M10	45	40
1/2" - 24	45	40
1/2" - 13, M12	65	50
3/4" - 20	65	50

*1 N•m = 0.7375 lb-ft

Overloads

The design of Cooper Bussmann® fuses is such that they can be operated under rather severe operating conditions imposed by overloads (any load current in excess of the maximum permissible load current).

In applications, there will be a maximum overload current, I_{max} , which can be imposed on the fuse with a corresponding duration and frequency of occurrence.

Time durations fall into two categories:

1. Overloads longer than one second
2. Overloads less than one second termed "impulse" loads.

The following table gives general application guidelines which, in the expression $I_{max} < (\% \text{ factor}) \times I_t$, I_t is the

melting current corresponding to the time "t" of the overload duration as read from the time-current curve of the fuse. The guidelines in the table below determine the acceptability of the selected fuses for a given I_{max} .

Frequency of Occurrence	Overloads (> 1 sec)	Impulse Loads (< 1 sec)
Less than once per month	$I_{max} < 80\% \times I_t$	$I_{max} < 70\% \times I_t$
Less than twice per week	$I_{max} < 70\% \times I_t$	$I_{max} < 60\% \times I_t$
Several times per day	$I_{max} < 60\% \times I_t$	—

When impulse loads are an intrinsic/normal parameter of the load current either as single pulse or in trains of pulses or when their level is higher than the melting current at 0.01 seconds (per time-current curve), contact Cooper Bussmann for application assistance.

In addition to the parameters set forth in the preceding table, the RMS value of the load current as calculated for any period of 10 minutes or more should not exceed the maximum permissible load current.

Furthermore, it is important that a fuse should not be applied in the non-continuous/dashed portion of the associated time-current curve.

Any time-current combination point which falls in the non-continuous/dashed portion of the time-current curve is beyond the capability of the fuse to operate properly.

DC Operation

Depending upon the short-circuit time constant and the magnitude of the prospective short-circuit current, the dc voltage at which a fuse can be applied may be less than its ac rating. Long time constants require a lower dc voltage. Conversely, however, higher available prospective short-circuit currents result in faster fuse openings and thus permit a fuse to be operated at a higher DC voltage.

Consult Cooper Bussmann for additional information and application assistance when fuses have to operate under DC conditions.

Load Current Versus Conductor Cross Section

Reduction of permissible load current when the conductor cross section is less than that given in IEC Publication 269-1 & 4 valid for Cooper Bussmann high speed fuses.

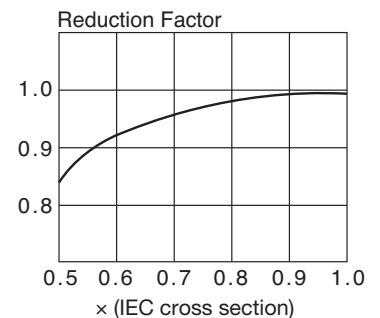

Application Assistance

If you have application problems or need a fuse outside our standard program, please contact the nearest Cooper Bussmann representative. Phone numbers are shown on the back cover.

High Speed Fuses

North American Fuses



Introduction

North American Contents

Catalog Number	Volts	Amp Range	Page
DFJ	600	1-600	97
FWA	130	1000-4000	98-99
FWA	150	70-1000	100-101
FWX	250	35-2500	102-103
FWH	500	35-1600	104-105
KAC	600	1-1000	106
KBC	600	35-800	107
FWP	700	5-1200	108-110
FWJ	1000	35-2000	111-112

Accessories

Fuse Bases 113

North American Fuse Ranges

Amps	Volts	AC	DC
1000-4000	130	X	X
70-1000	150	X	X
35-2500	250	X	X
35-1600	500	X	X
1-1000	600	X	—
5-1200	700	X	X
40-600	800	—	X
35-2000	1000	X	—

General Information

Cooper Bussmann offers a complete range of North American blade and flush-end style fuses and accessories. Their design and construction were optimized to provide:

- Low energy let-through (I²t)
- Low watts loss
- Superior cycling capability
- Low arc voltage
- Excellent DC performance

North American style fuses provide an excellent solution for medium power applications. While there are currently no published standards for these fuses, the industry has standardized on mounting centers that accept Cooper Bussmann fuses.

Voltage Rating

All Cooper Bussmann® North American style fuses are tested at their rated voltage. Cooper Bussmann should be consulted for applications exceeding those values.

Accessories

External and internal open fuse indication is available for selected portions of the North American line. Fuse blocks are available for most applications.

Drive Fuse High Speed Fuses

DFJ Class J



Specifications

Description: High speed, current-limiting fuse. The Cooper Bussmann® Drive Fuse will provide maximum protection for AC and DC drives and controllers and meet NEC® branch circuit protection requirements. The Drive Fuse has the lowest I^2t of any branch circuit fuse to protect power semiconductor devices that utilize diodes, GTOs, SCRs and SSRs.

Dimensions: See page 15 for Class J dimensions.

Construction: Melamine tube with silver fuse element.

Ratings:

Volts — 600Vac (or less), 450Vdc (or less)

Amps — 1-600A

IR — 200kA RMS Sym., 100kA DC

Agency Information: CE, Std. 248-8, Class J, UL Listed, Guide JDDZ, File E4273, CSA Certified, Class 1422-02, File 53787.

Features and Benefits

- Easily coordinated with existing and new variable speed drives and electric controllers.
- Standard Class J dimensions allowing the use of readily available fuse blocks, holders, and switches.
- Allows the lowest let-thru energy of any branch circuit overcurrent protective device.

Typical Applications

- Protection of ac & dc drives
- Equipment using power semi-conductor devices

Catalog Numbers (Amps)

DFJ-1	DFJ-15	DFJ-70	DFJ-225
DFJ-2	DFJ-20	DFJ-80	DFJ-250
DFJ-3	DFJ-25	DFJ-90	DFJ-300
DFJ-4	DFJ-30	DFJ-100	DFJ-350
DFJ-5	DFJ-35	DFJ-110	DFJ-400
DFJ-6	DFJ-40	DFJ-125	DFJ-450
DFJ-8	DFJ-45	DFJ-150	DFJ-500
DFJ-10	DFJ-50	DFJ-175	DFJ-600
DFJ-12	DFJ-60	DFJ-200	

Data Sheet: 1048

Time-Current Characteristic Curves—Average Melt

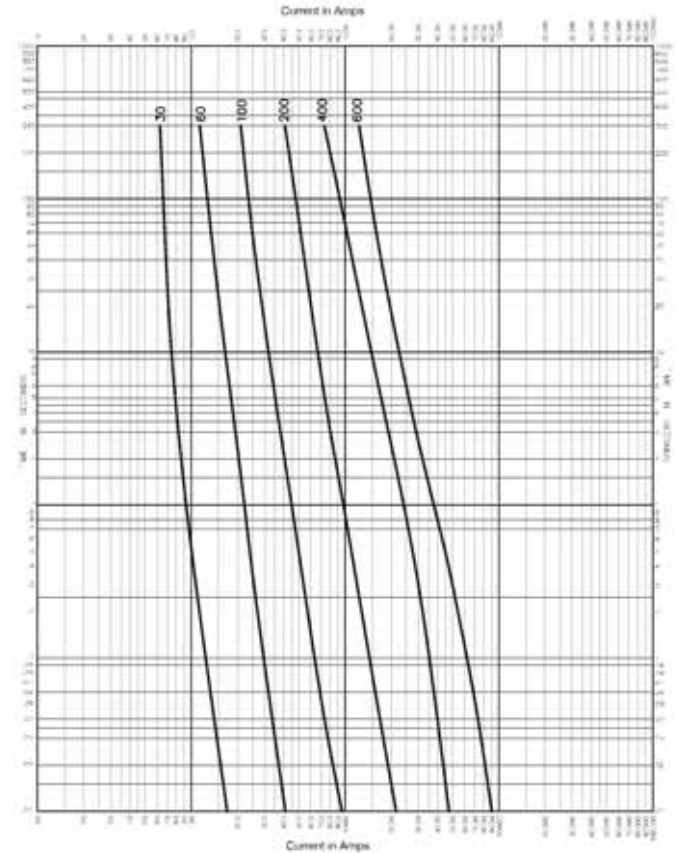

Current Limitation Curves

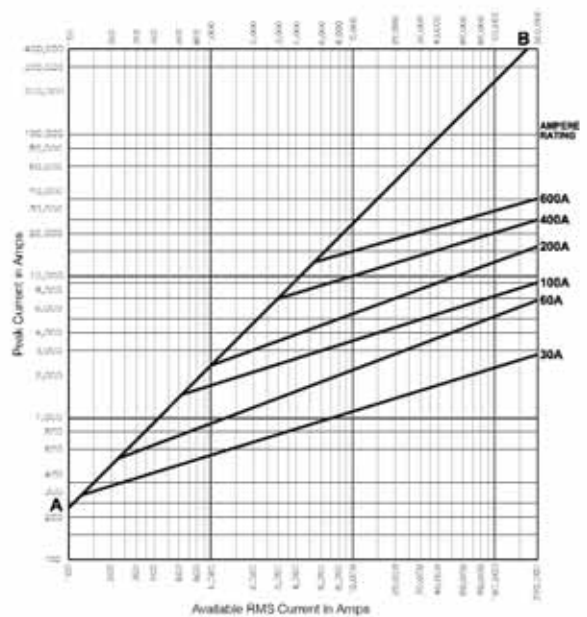

North American — FWA 130V: 1000-4000A

FWA

Specifications

Description: North American style flush-end high speed fuses.

Dimensions: See Dimensions illustrations.

Ratings:

- Volts: — 130Vac
- Amps: — 1000-4000A
- IR: — 200kA RMS Sym.
- 50kA @130Vdc

Agency Information: CE, UL Recognized on 1000-2000A fuses

Electrical Characteristics

Total Clearing I^2t

The total clearing I^2t at rated voltage and at power factor of 15% are given in the electrical characteristics. For other voltages, the clearing I^2t is found by multiplying by correction factor, K, given as a function of applied working voltage, E_g , (rms).

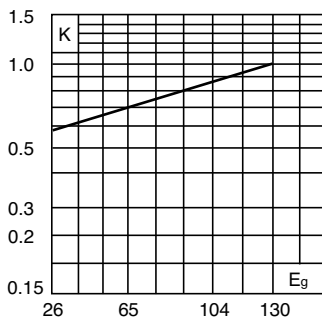

Arc Voltage

This curve gives the peak arc voltage, U_L , which may appear across the fuse during its operation as a function of the applied working voltage, E_g , (rms) at a power factor of 15%.

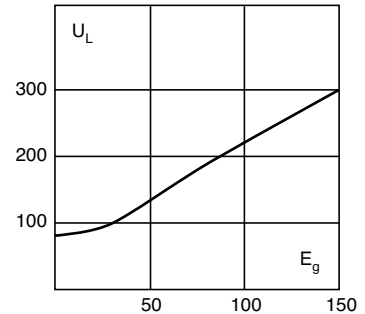

Power Losses

Watts loss at rated current is given in the electrical characteristics. The curve allows the calculation of the power losses at load currents lower than the rated current. The correction factor, K_p , is given as a function of the RMS load current, I_b , in % of the rated current.

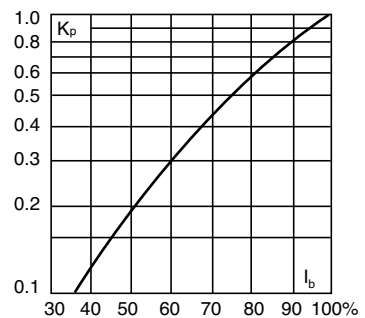

Catalog Numbers

Catalog Numbers	Electrical Characteristics			
	Rated Current RMS-Amps	I^2t (A ² Sec)		Watts Loss
		Pre-arc	Clearing at 130V	
FWA-1000AH	1000	170000	460000	60
FWA-1200AH	1200	270000	730000	70
FWA-1500AH	1500	520000	1400000	78
FWA-2000AH	2000	860000	2400000	108
FWA-2500AH	2500	1500000	4100000	130
FWA-3000AH	3000	2100000	5700000	150
FWA-4000AH	4000	3400000	9200000	257

• Watts loss provided at rated current.
• See accessories on page 113.

Features and Benefits

- Excellent DC performance
- Low arc voltage and low energy let-through (I^2t)
- Low watts loss
- Superior cycling capability

Typical Applications

- DC common bus
- DC drives
- Power converters/rectifiers
- Reduced voltage starters

Dimensions (in)

Catalog Number	Fig.	B	C	D	Thread Depth
FWA-1000AH-2000AH	1	2.0	1.0	—	Tapped $\frac{3}{8}$ "-24 x $\frac{1}{2}$ "
FWA-2500AH-3000AH	1	3.0	1.5	—	Tapped $\frac{1}{2}$ "-20 x $\frac{1}{2}$ "
FWA-4000AH	2	3.5	1.5	1.5	Tapped $\frac{1}{2}$ "-20 x $\frac{1}{2}$ "

1mm = 0.0394" / 1" = 25.4mm

Fig. 1: 1000-3000A

Fig. 2: 4000A

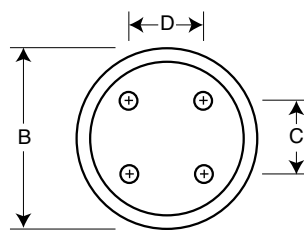
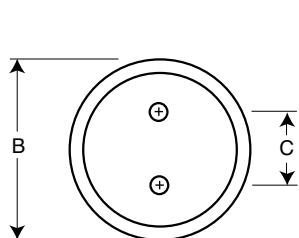
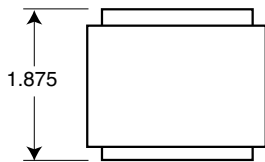
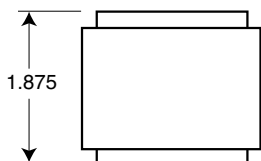

North American — FWA 130V: 1000-4000A

FWA 1000-4000A: 130V

Time-Current Curve

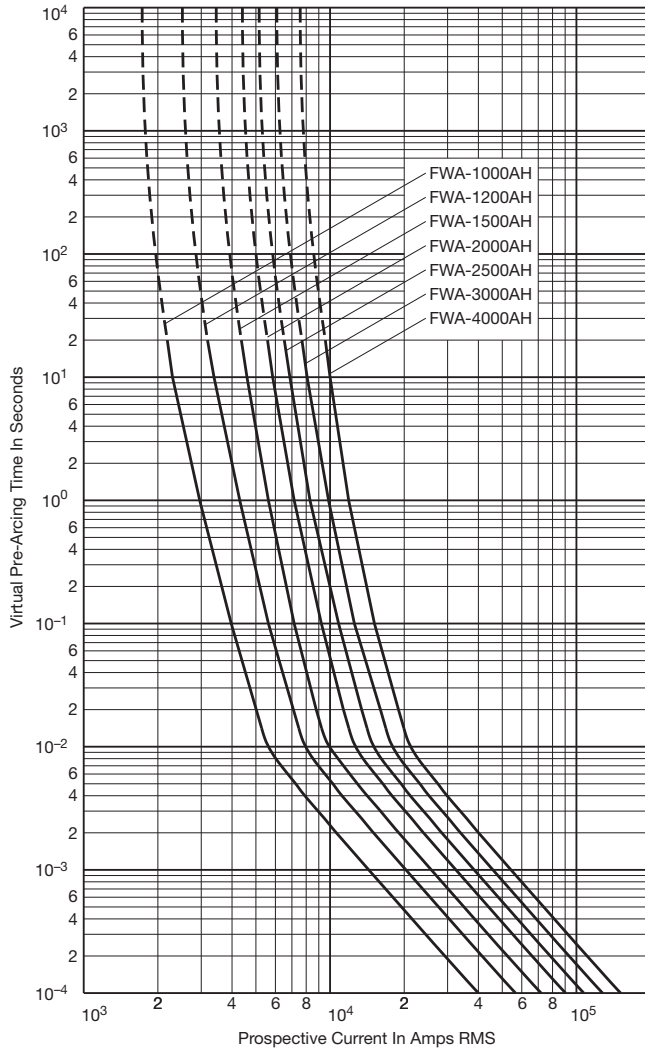

Peak Let-Through Curve

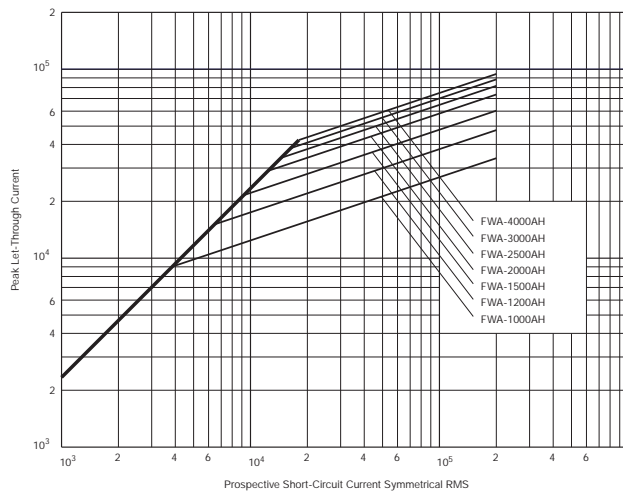

Data Sheet: 35785301

North American — FWA 150V: 70-1000A

FWA

Specifications

Description: North American style stud-mount fuses.

Dimensions: See Dimensions illustrations.

Ratings:

- Volts: — 150Vac/dc
- Amps: — 70-1000A
- IR: — 100kA Sym. (70-400A)
- 200kA Sym. (450-1000A)
- 20kA @ 150Vdc (70-800A)
- 100kA @ 80Vdc (70-400A)

Agency Information: CE, UL Recognized

Electrical Characteristics

Total Clearing I²t

The total clearing I²t at rated voltage and at power factor of 15% are given in the electrical characteristics. For other voltages, the clearing I²t is found by multiplying by correction factor, K, given as a function of applied working voltage, E_g, (rms).

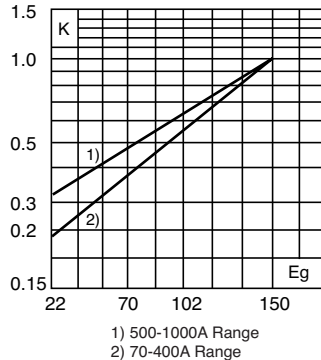

Arc Voltage

This curve gives the peak arc voltage, U_L, which may appear across the fuse during its operation as a function of the applied working voltage, E_g, (rms) at a power factor of 15%.

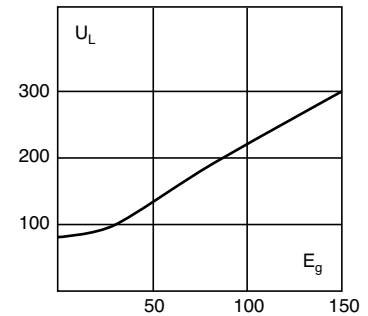

Power Losses

Watts loss at rated current is given in the electrical characteristics. The curve allows the calculation of the power losses at load currents lower than the rated current. The correction factor, K_p, is given as a function of the RMS load current, I_b, in % of the rated current.

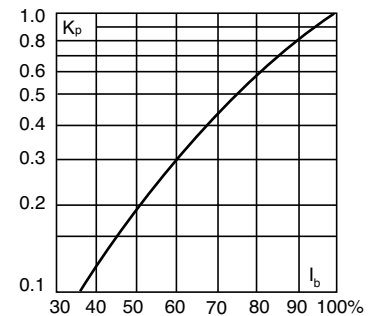

Catalog Numbers

Catalog Number	Rated Current RMS-Amps	Electrical Characteristics		
		Pt (A ² Sec)		Watts Loss
		Pre-arc	Clearing at 150V	
FWA-70B	70	470	4000	6.9
FWA-80B	80	670	6000	7.7
FWA-100B	100	1200	12000	9.0
FWA-125B	125	1870	18000	11.2
FWA-150B	150	2700	26000	13.5
FWA-200B	200	4780	45000	17.6
FWA-250B	250	7470	70000	22.5
FWA-300B	300	10760	100000	27.0
FWA-350B	350	15700	140000	30.6
FWA-400B	400	20300	180000	35.2
FWA-500A	500	39000	120000	35.0
FWA-600A	600	46000	140000	47.0
FWA-700A	700	75000	220000	49.0
FWA-800A	800	92000	280000	58.0
FWA-1000A	1000	170000	510000	60.0

• Watts loss provided at rated current.
• See accessories on page 113.

Features and Benefits

- Excellent DC performance
- Low arc voltage and low energy let-through (I²t)
- Low watts loss
- Superior cycling capability

Typical Applications

- DC common bus
- DC drives
- Power converters/rectifiers
- Reduced voltage starters

Dimensions (in)

Fig. 1: 70-400A

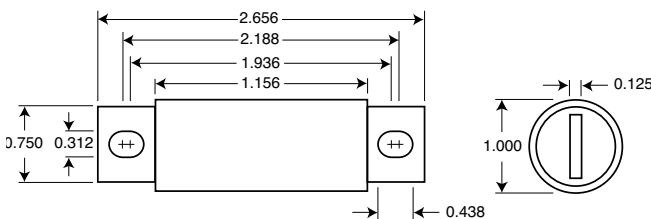
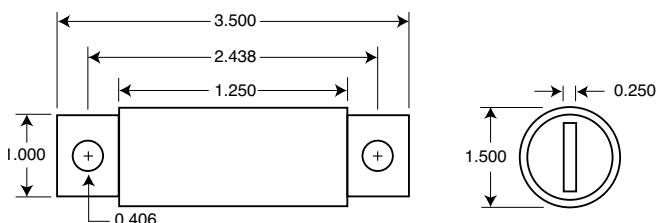

Fig. 2: 500-1000A



1mm = 0.0394" / 1" = 25.4mm

North American — FWA 150V: 70-1000A

FWA 70-1000A: 150V

Time-Current Curve

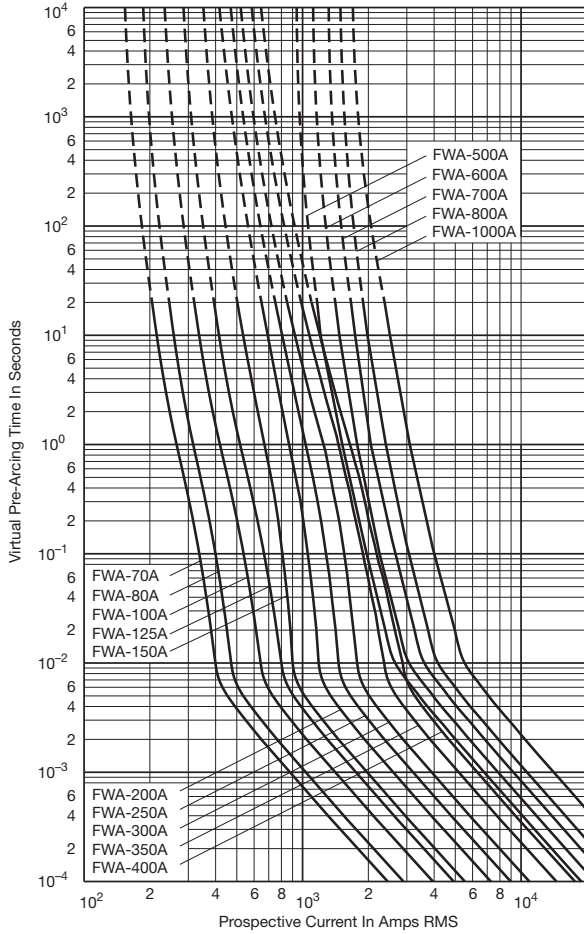

Peak Let-Through Curve

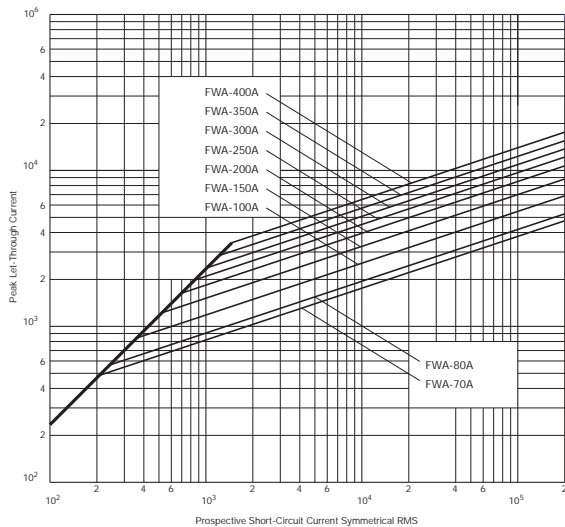

Data Sheet: 35785310

North American — FWX 250V: 35-2500A

FWX

Specifications

Description: North American style stud-mount and flush-end fuses.

Dimensions: See Dimensions illustrations.

Ratings:

Volts: — 250Vac/dc

Amps: — 35-2500A

IR: — 200kA RMS Sym.

Agency Information: CE, UL Recognized & CSA Component Acceptance on 35-800A fuses (20kA IR @250Vdc).



Electrical Characteristics

Total Clearing I²t

The total clearing I²t at rated voltage and at power factor of 15% are given in the electrical characteristics. For other voltages, the clearing I²t is found by multiplying by correction factor, K, given as a function of applied working voltage, E_g, (rms).

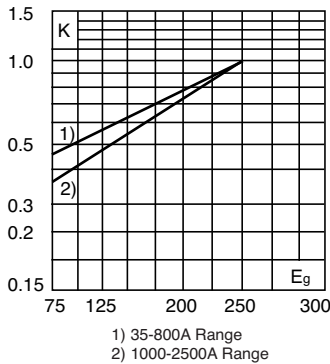

Dimensions (in)

Amp Range	Fig.	A	B	C	D	E	F	G	H	J	Tapped Thread Depth
35-60	1	3.19	0.81	1.59	2.59	2.25	0.34	0.63	0.13	0.52	—
70-200	1	3.13	1.22	1.59	2.44	2.19	0.34	1.00	0.19	0.47	—
225-600	1	3.84	1.50	1.59	2.94	2.25	0.41	1.00	0.25	0.75	—
700-800	1	3.84	2.00	1.59	3.03	2.28	0.41	1.50	0.25	0.78	—
1000-1200	2	2.59	3.00	1.50	—	—	—	—	—	—	3/8"-24 x 1/2"
1500-2500	3	2.59	3.50	1.50	1.50	—	—	—	—	—	3/8"-24 x 1/2"

1mm = 0.0394" / 1" = 25.4mm

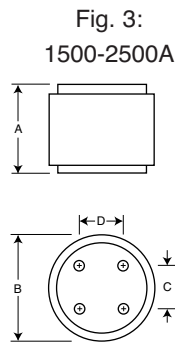
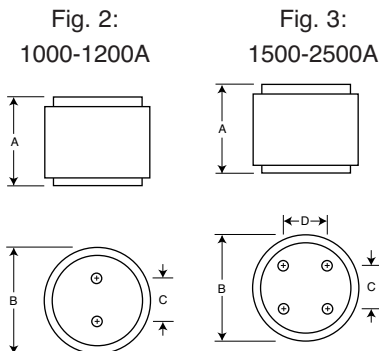
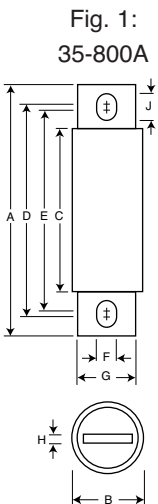

Arc Voltage

This curve gives the peak arc voltage, U_L, which may appear across the fuse during its operation as a function of the applied working voltage, E_g, (rms) at a power factor of 15%.

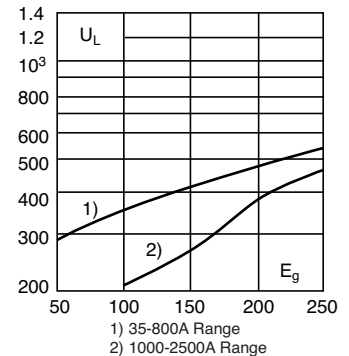

Power Losses

Watts loss at rated current is given in the electrical characteristics. The curve allows the calculation of the power losses at load currents lower than the rated current. The correction factor, K_p, is given as a function of the RMS load current, I_b, in % of the rated current.

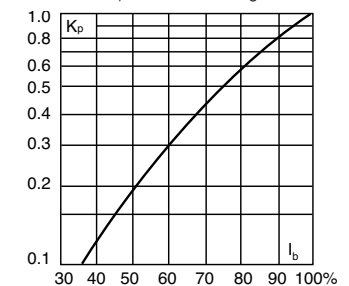

Catalog Numbers

Catalog Number	Rated Current RMS-Amps	Electrical Characteristics		
		Pt (A ² Sec)		Watts Loss
		Pre-arc	Clearing at 250V	
FWX-35A	35	50	230	4.2
FWX-40A	40	60	310	5.2
FWX-45A	45	80	390	5.7
FWX-50A	50	100	520	6.0
FWX-60A	60	140	740	8.1
FWX-70A	70	330	1400	7.2
FWX-80A	80	430	1850	8.1
FWX-90A	90	570	2450	9.0
FWX-100A	100	740	3150	10.0
FWX-125A	125	1130	4850	12.5
FWX-150A	150	1620	6950	15.7
FWX-175A	175	2170	9300	18.5
FWX-200A	200	2790	12000	22
FWX-225A	225	3210	14700	24
FWX-250A	250	3960	18100	27
FWX-275A	275	4720	21600	31
FWX-300A	300	6000	27300	32
FWX-350A	350	10600	48600	39
FWX-400A	400	14500	66100	44
FWX-450A	450	22100	101000	49
FWX-500A	500	28000	128000	54
FWX-600A	600	41100	188000	62
FWX-700A	700	48800	190000	72
FWX-800A	800	59000	230000	84
FWX-1000AH	1000	44000	360000	100
FWX-1200AH	1200	92000	750000	103
FWX-1500AH	1500	120000	880000	140
FWX-1600AH	1600	160000	1200000	140
FWX-2000AH	2000	320000	2300000	151
FWX-2500AH	2500	670000	4700000	163

• Watts loss provided at rated current. • See accessories on page 113.

Features and Benefits

- Excellent DC performance
- Low arc voltage and low energy let-through (I²t)
- Superior cycling capability

Typical Applications

- DC common bus
- DC drives
- Power converters/rectifiers
- Reduced voltage starters

Data Sheet: 720005

North American — FWX 250V: 35-2500A

FWX 35-800A: 250V

Time-Current Curve

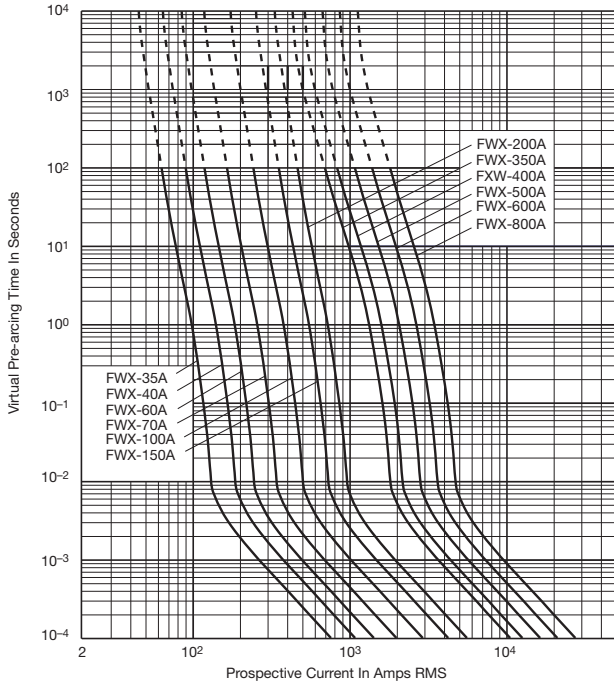

Peak Let-Through Curve

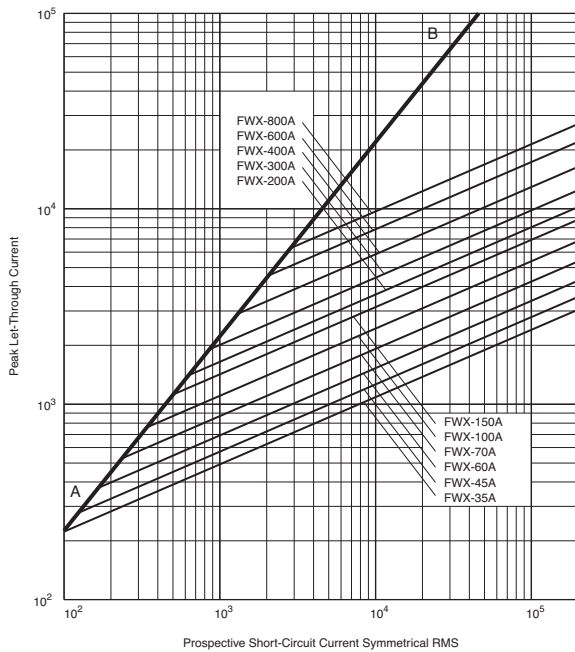

Data Sheet: 359

FWX 1000-2500A(H): 250V

Time-Current Curve

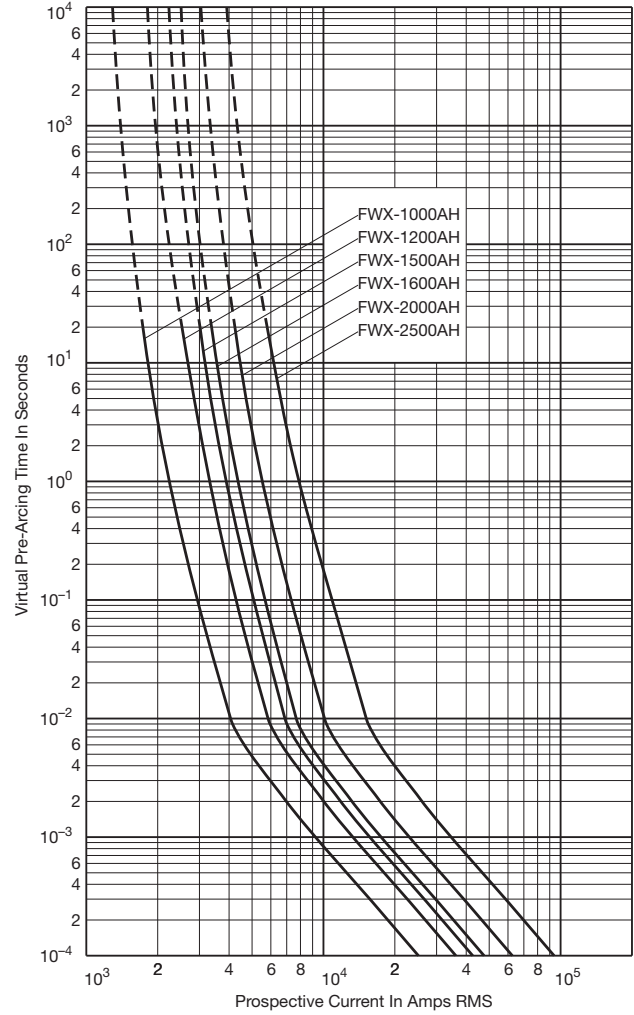

Peak Let-Through Curve

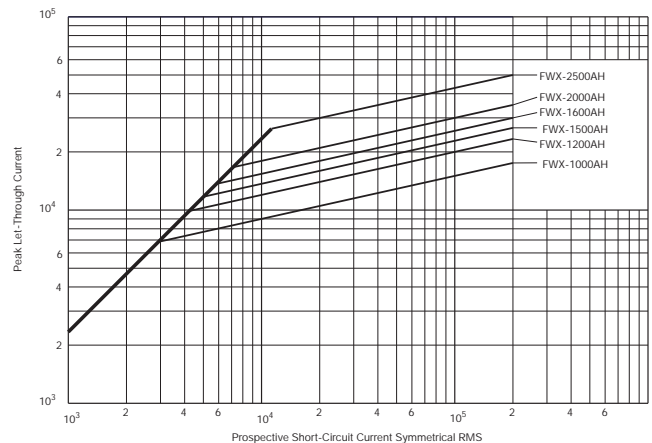

Data Sheet: 35785299

High Speed Fuses

North American — FWH 500V: 35-1600A

FWH

Specifications

Description: North American style stud-mount fuses.

Dimensions: See Dimensions illustration.

Ratings:

Volts: — 500Vac/dc

Amps: — 35-1600A

IR: — 200kA Sym.

— 50kA @ 500Vdc

Agency Information: CE, UL Recognition & CSA Component Acceptance on 35-800A only (50kA IR@500Vdc). UL Recognition on 35-1200A only, CSA Component Acceptance: 35-1600A.

Electrical Characteristics

Total Clearing I^2t

The total clearing I^2t at rated voltage and at power factor of 15% are given in the electrical characteristics. For other voltages, the clearing I^2t is found by multiplying by correction factor, K, given as a function of applied working voltage, E_g , (rms).

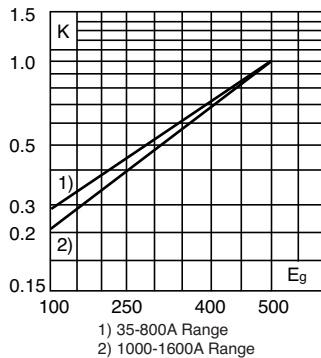

Dimensions (in)

Amp Range	Fig.	A	B	C	D	E	F	G	H	J
35-60	1	3.188	0.813	1.593	2.541	2.193	0.344	0.719	0.125	0.518
70-100	1	3.625	0.947	1.736	2.853	2.807	0.352	0.750	0.125	0.375
125-200	1	3.625	1.156	1.836	2.892	2.768	0.344	1.000	0.188	0.406
225-400	1	4.340	1.500	2.090	3.440	2.750	0.410	1.000	0.250	0.750
450-600	1	4.340	2.000	2.090	3.530	2.780	0.410	1.500	0.250	0.780
700-800	1	6.340	2.500	2.090	4.970	3.440	0.530	2.000	0.380	1.300
1000-1200	1	6.969	3.000	3.219	5.465	4.475	0.625	2.375	0.438	1.120
1400-1600	2	See Drawing								

1mm = 0.0394" / 1" = 25.4mm

Fig. 1: 35-1200A

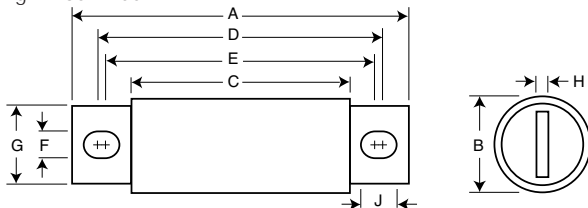
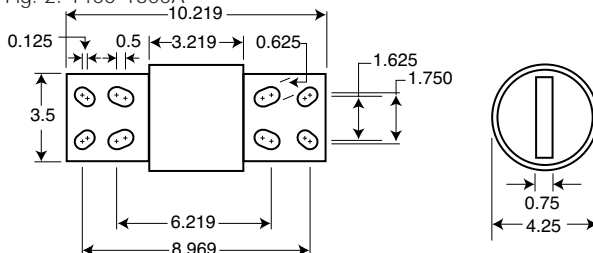
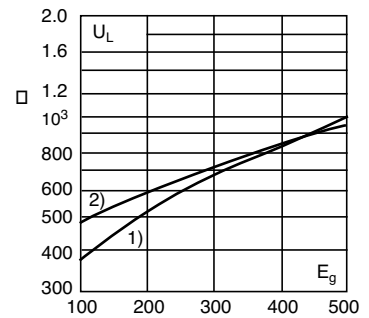

Fig. 2: 1400-1600A



Arc Voltage

This curve gives the peak arc voltage, U_L , which may appear across the fuse during its operation as a function of the applied working voltage, E_g , (rms) at a power factor of 15%.



Power Losses

Watts loss at rated current is given in the electrical characteristics. The curve allows the calculation of the power losses at load currents lower than the rated current. The correction factor, K_p , is given as a function of the RMS load current, I_b , in % of the rated current.

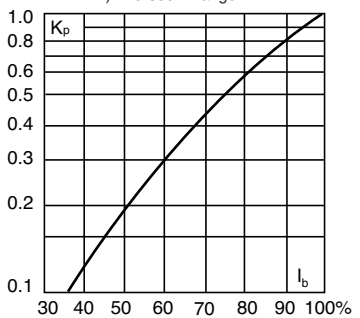

Catalog Numbers

Catalog Numbers	Rated Current RMS-Amps	Electrical Characteristics		
		I^2t (A ² Sec)		Watts Loss
		Pre-arc	Clearing at 500V	
FWH-35B	35	34	150	8
FWH-40B	40	76	320	7.5
FWH-45B	45	105	450	7.5
FWH-50B	50	135	670	7.5
FWH-60B	60	210	900	9.9
FWH-70B	70	210	900	10.6
FWH-80B	80	305	1400	12.7
FWH-90B	90	360	1600	15
FWH-100B	100	475	2000	17
FWH-125B	125	800	3500	25
FWH-150B	150	1100	4600	30
FWH-175B	175	1450	6200	35
FWH-200B	200	1900	8500	40
FWH-225A	225	4600	23300	39
FWH-250A	250	6300	32200	41
FWH-275A	275	7900	40300	46
FWH-300A	300	9800	49800	51
FWH-325A	325	13700	63800	53
FWH-350A	350	14500	72900	58
FWH-400A	400	19200	96700	65
FWH-450A	450	24700	127000	74
FWH-500A	500	29200	149000	84
FWH-600A	600	41300	206000	108
FWH-700A	700	55000	298000	120
FWH-800A	800	76200	409000	129
FWH-1000A	1000	92000	450000	145
FWH-1200A	1200	122000	600000	180
FWH-1400A	1400	200000	1000000	210
FWH-1600A	1600	290000	1400000	230

* Watts loss provided at rated current. * See accessories on page 113.

Features and Benefits

- Excellent DC performance
- Low arc voltage and low energy let-through (I^2t)
- Superior cycling capability

Typical Applications

- DC common bus
- DC drives
- Power converters/rectifiers
- Reduced voltage starters

Data Sheet: 720007

North American — FWH 500V: 35-1600A

FWH 35-200A(B) & 900-1600A(A): 500V

Time-Current Curve

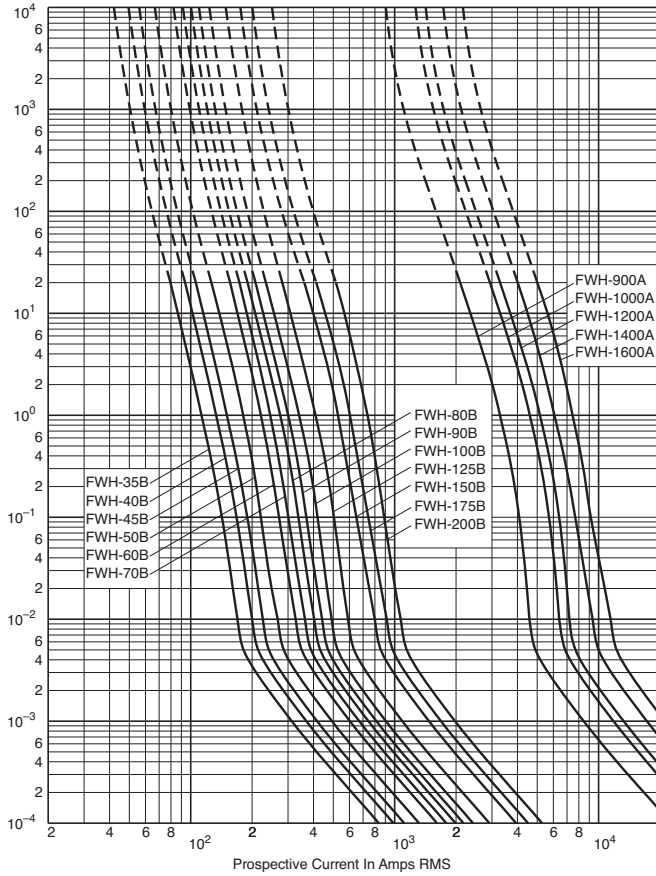

FWH 250-800A: 500V

Time-Current Curve

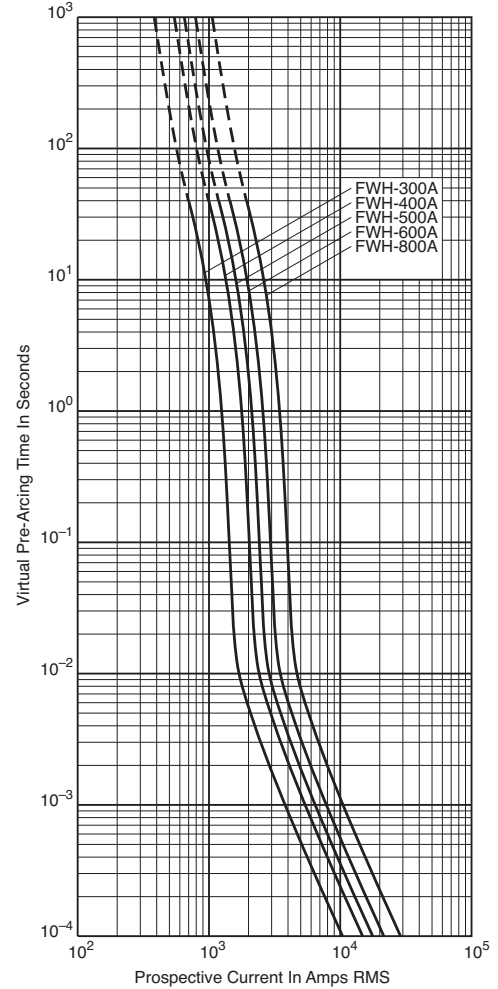

High Speed Fuses

Peak Let-Through Curve

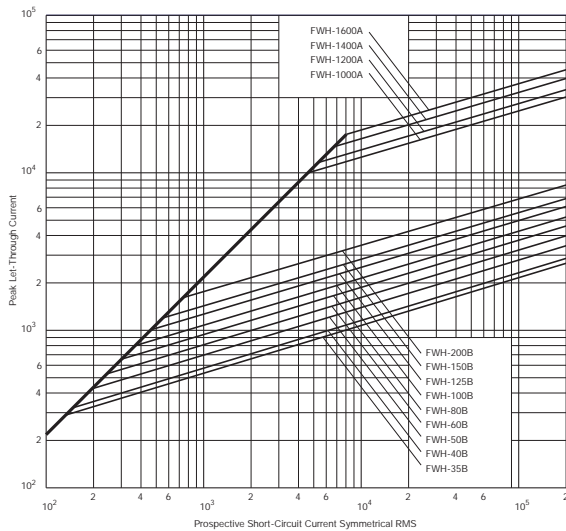

Peak Let-Through Curve

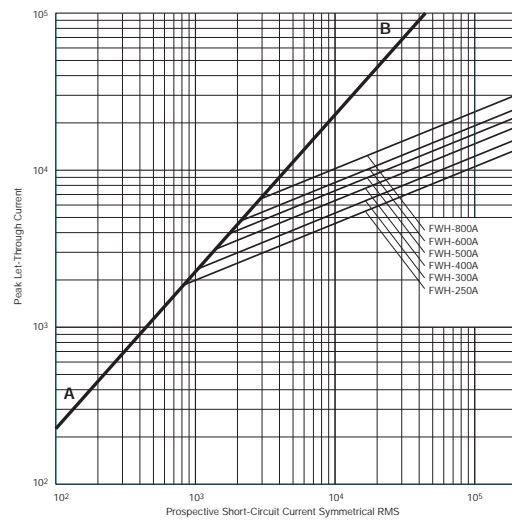

North American — KAC 600V: 1-1000A

KAC

Specifications

Description: North American style stud-mount fuses. These 600V fuses are supplied as replacements only. For new installations, Cooper Bussmann recommends the 700V FWP Series fuse.

Dimensions: See Dimensions illustrations.

Ratings:

- Volts: — 600Vac
- Amps: — 1-1000A
- IR: — 200kA RMS Sym.

Agency Information: CE, UL Recognition on 1-600A only.



Catalog Numbers (Amps)

KAC-1	KAC-25	KAC-175
KAC-2	KAC-30	KAC-200
KAC-3	KAC-35	KAC-225
KAC-4	KAC-40	KAC-250
KAC-5	KAC-45	KAC-300
KAC-6	KAC-50	KAC-350
KAC-7	KAC-60	KAC-400
KAC-8	KAC-70	KAC-450
KAC-9	KAC-80	KAC-500
KAC-10	KAC-90	KAC-600
KAC-12	KAC-100	KAC-700
KAC-15	KAC-110	KAC-800
KAC-17.5	KAC-125	KAC-1000
KAC-20	KAC-150	

* See accessories on page 113.

Features and Benefits

- Low arc voltage and low energy let-through (I^2t)
- Low watts loss
- Superior cycling capability

Typical Applications

- Power converters/rectifiers
- Reduced voltage starters

Dimensions (in)

Amp Range	Fig.	A	B1	B2	B3	C	D	E	F	G	H
1-30A	1	2.875	2.500	—	—	1.875	0.406	—	0.563	0.063	0.257
35-60A	2	4.375	—	3.750	3.500	2.750	0.625	0.343	0.813	0.094	0.468
70-100A	2	5.000	—	4.063	3.656	2.750	0.750	0.406	1.000	0.125	0.609
110-200A	2	5.140	—	4.390	3.766	2.906	1.000	0.406	1.500	0.188	0.718
225-400A	2	6.182	—	4.815	4.565	3.000	1.625	0.562	2.000	0.250	0.687
450-800A	1	6.250	4.750	—	—	3.063	2.000	—	2.500	0.250	0.563
1000A	1	7.250	4.750	—	—	3.063	2.750	—	3.500	0.375	0.563

1mm = 0.0394" / 1" = 25.4mm

Fig. 1: 1-30 & 450-1000A

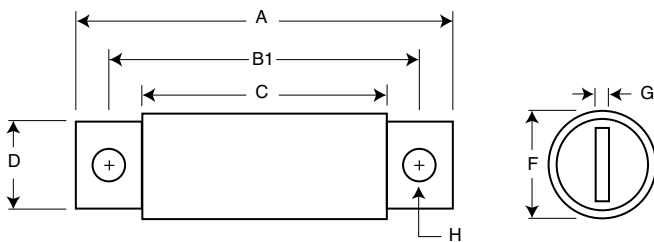
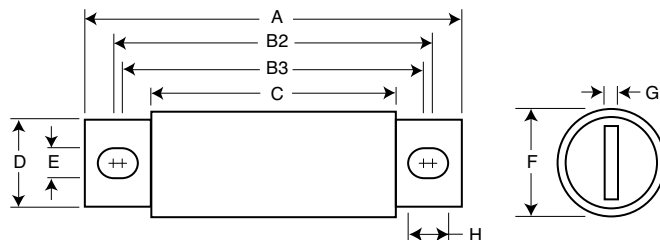

Fig. 2: 35-400A



North American — KBC 600V: 35-800A

KBC

Specifications

Description: North American style stud-mount and flush-end fuses. These 600V fuses are supplied as replacements only. For new installations, Cooper Bussmann recommends the 700V FWP Series fuse.

Dimensions: See Dimensions illustrations.

Ratings:

Volts: — 600Vac

Amps: — 35-800A

IR: — 200kA RMS Sym.

Agency Information: CE, UL Recognition on 35-600A only.



Catalog Numbers (Amps)

KBC-35	KBC-100	KBC-300
KBC-40	KBC-110	KBC-350
KBC-45	KBC-125	KBC-400
KBC-50	KBC-150	KBC-450
KBC-60	KBC-175	KBC-500
KBC-70	KBC-200	KBC-600
KBC-80	KBC-225	KBC-800
KBC-90	KBC-250	

• See accessories on page 113.

Features and Benefits

- Low arc voltage and low energy let-through (I^2t)
- Low watts loss
- Superior cycling capability

Typical Applications

- Power converters/rectifiers
- Reduced voltage starters

High Speed Fuses

Dimensions (in)

Amp Range	Fig.	A	B	C	D	E	F	G	H	I	
35-60A	1	4.375	3.750	3.500	2.750	0.343	0.625	0.813	0.094	0.468	
70-100A	2	See Drawing									
110-200A	1	4.406	3.719	3.594	2.906	0.312	0.875	1.219	0.187	0.375	
225-400A	1	5.125	4.188	3.563	2.906	0.406	1.000	1.500	0.250	0.719	
450-600A	1	5.125	4.389	3.687	2.875	0.406	1.500	2.000	0.250	0.757	
800A	3	See Drawing									

1mm = 0.0394" / 1" = 25.4mm

Fig. 1: 35-60 and 110-600A

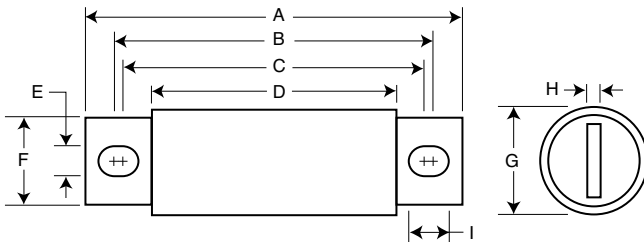

Fig. 2: 70-100A

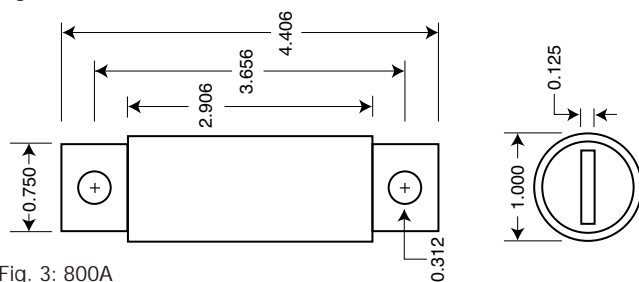
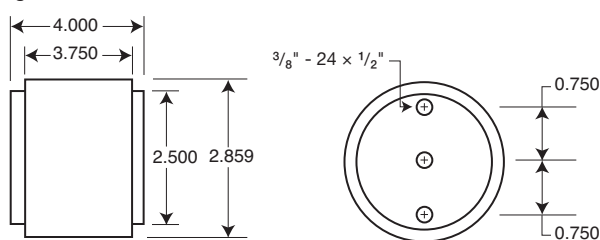

Fig. 3: 800A



Data Sheet: 720010

North American — FWP 700V: 5-1200A

FWP

Specifications

Description: North American style stud-mount fuses.

Dimensions: See Dimensions illustrations.

Ratings:

Volts: — 700Vac/dc

Amps: — 5-1200A

IR: — 200kA RMS Sym.

— 50kA @700Vdc

Agency Information: CE, UL Recognition & CSA Component Acceptance on 5-800A

Electrical Characteristics

Total Clearing I²t

The total clearing I²t at rated voltage and at power factor of 15% are given in the electrical characteristics. For other voltages, the clearing I²t is found by multiplying by correction factor, K, given as a function of applied working voltage, E_G, (rms).

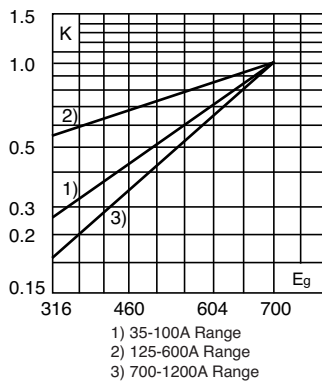

Dimensions (in)

Amp Range	Fig.	A	B	C	D	E	F	G	H	I
5-30	1	2.870	0.563	1.855	2.477	2.477	0.250	0.405	0.063	0.250
35-60	1	4.375	0.813	2.750	3.708	3.312	0.344	0.725	0.125	0.542
70-100	1	4.406	0.947	2.594	3.625	3.563	0.344	0.750	0.125	0.375
125-200	1	5.090	1.500	2.840	4.190	3.500	0.410	1.000	0.250	0.750
225-400	1	5.090	2.000	2.840	4.280	3.530	0.410	1.500	0.250	0.780
450-600	1	7.090	2.500	2.840	5.720	4.190	0.530	2.000	0.380	1.300
700-800	1	6.630	2.000	2.844	5.562	5.062	0.625	1.500	0.250	0.875
900-1000	2	See Drawing								
1200	3	See Drawing								

1mm = 0.0394" / 1" = 25.4mm

Fig. 1: 5-800A

Fig. 2: 900-1000A

Fig. 3: 1200A

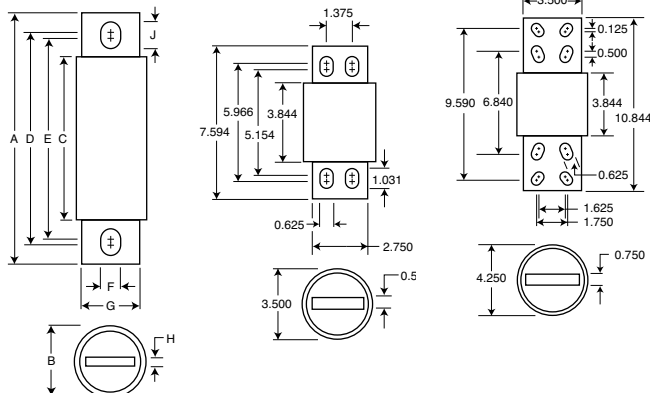

Arc Voltage

This curve gives the peak arc voltage, U_L, which may appear across the fuse during its operation as a function of the applied working voltage, E_G, (rms) at a power factor of 15%.

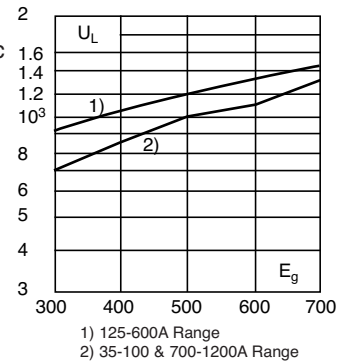

Power Losses

Watts loss at rated current is given in the electrical characteristics. The curve allows the calculation of the power losses at load currents lower than the rated current. The correction factor, K_p, is given as a function of the RMS load current, I_b, in % of the rated current.

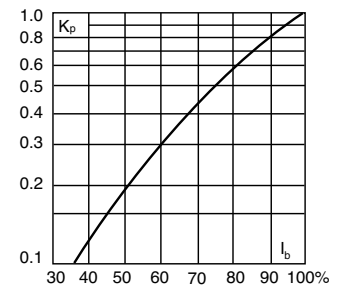

Catalog Numbers

Catalog Numbers	Rated Current RMS-Amps	Electrical Characteristics		
		Pt (A ² Sec)		Watts Loss
		Pre-arc	Clearing at 700V	
FWP-5B	5	1.6	10	1.5
FWP-10B	10	3.6	20	4
FWP-15B	15	10	75	5.5
FWP-20B	20	26	180	6
FWP-25B	25	44	340	7
FWP-30B	30	58	450	9
FWP-35B	35	34	160	12
FWP-40B	40	76	320	12
FWP-50B	50	135	600	12
FWP-60B	60	210	950	15.5
FWP-70B	70	305	2000	18
FWP-80B	80	360	2400	21
FWP-90B	90	415	2700	25
FWP-100B	100	540	3500	27
FWP-125A	125	1800	7300	28
FWP-150A	150	2900	11700	32
FWP-175A	175	4200	16700	35
FWP-200A	200	5500	22000	43
FWP-225A	225	7700	31300	45
FWP-250A	250	10500	42500	48
FWP-300A	300	17600	71200	58
FWP-350A	350	23700	95600	65
FWP-400A	400	31000	125000	78
FWP-450A	450	36400	137000	94
FWP-500A	500	45200	170000	107
FWP-600A	600	66700	250000	122
FWP-700A	700	54000	300000	125
FWP-800A	800	78000	450000	140
FWP-900A	900	91500	530000	150
FWP-1000A	1000	120000	600000	170
FWP-1200A	1200	195000	1100000	190

* Watts loss provided at rated current. * See accessories on page 113.

Features and Benefits

- Excellent DC performance
- Low arc voltage and low energy let-through (I²t)
- Superior cycling capability

Typical Applications

- DC common bus
- DC drives
- Power converters/rectifiers
- Reduced voltage starters

Data Sheet: 720012

North American — FWP 700V: 5-1200A

FWP 5-30A(B): 700V

Time-Current Curve

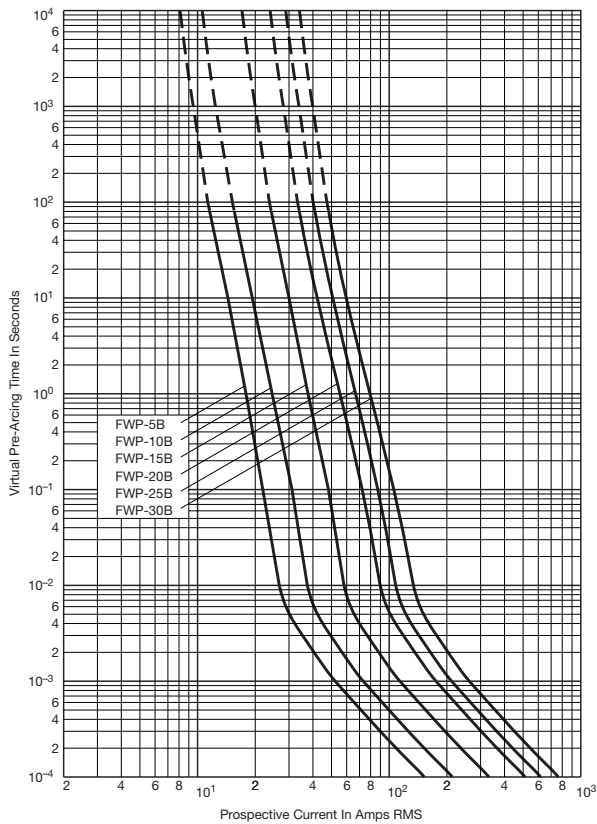

FWP 35-100A(B) & 700-1200A(A): 700V

Time-Current Curve

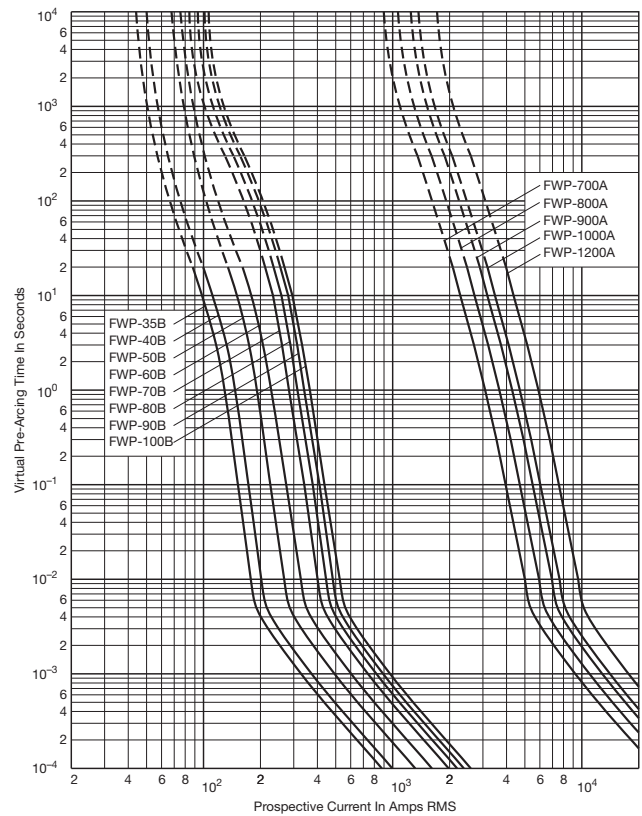

High Speed Fuses

Peak Let-Through Curve

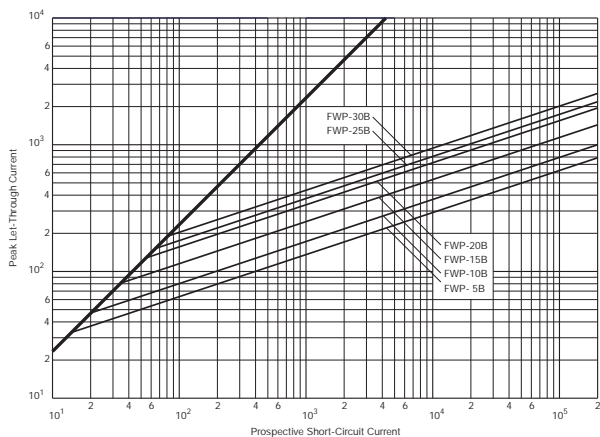

Peak Let-Through Curve

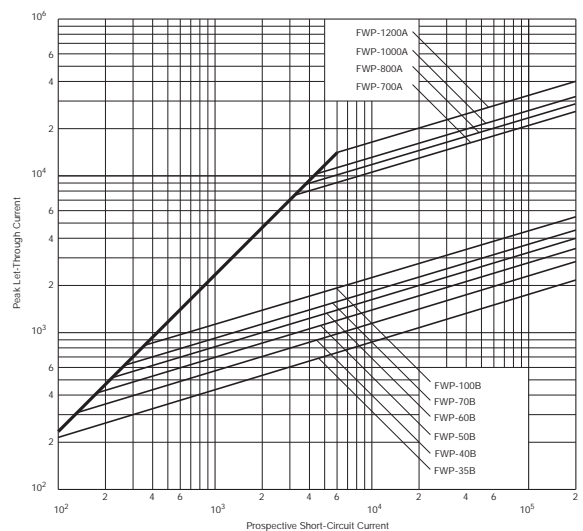

North American — FWP 700V: 5-1200A

FWP 150-600A: 700V

Time-Current Curve

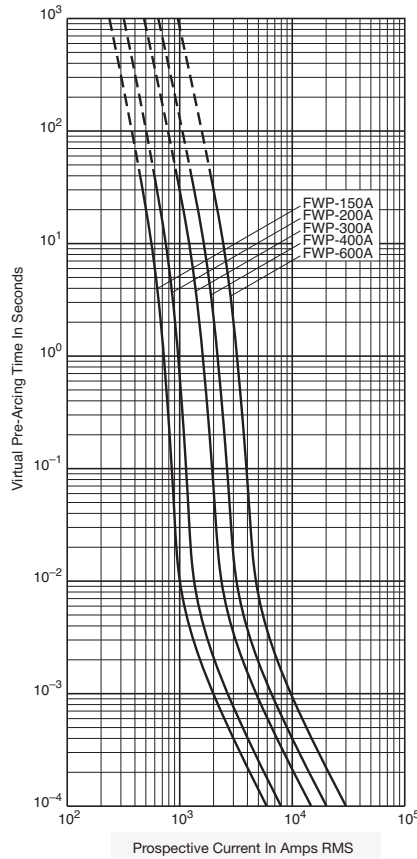

Peak Let-Through Curve

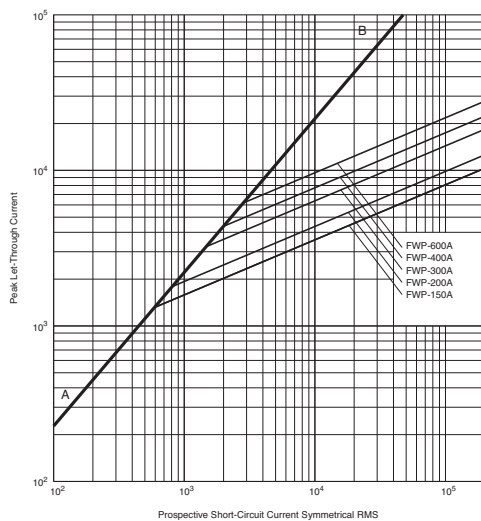

North American — FWJ 1000V: 35-2000A

FWJ

Specifications

Description: North American style stud-mount fuses.

Dimensions: See Dimensions illustration.

Ratings:

Volts: — 1000Vac

Amps: — 35-2000A

IR: — 25kA (35-200A)

— 100kA (250-2000A)

— 50kA @ 800Vdc (35-200A, 450-600A)

Agency Information: CE, UL Recognition File E91958 on 35-600A only.



Electrical Characteristics

Total Clearing I²t

The total clearing I²t at rated voltage and at power factor of 15% are given in the electrical characteristics. For other voltages, the clearing I²t is found by multiplying by correction factor, K, given as a function of applied working voltage, E_g, (rms).

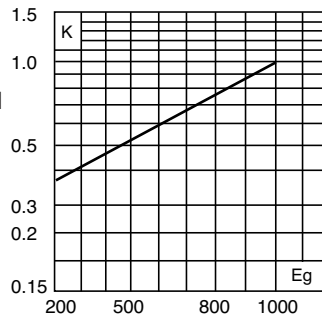

Dimensions (in)

Amp Range	Fig.	A	B	C	D	E	F	G	H	I
35-60	1	5.000	0.940	3.110	4.235	4.180	0.352	0.750	0.125	0.380
70-100	1	4.932	1.125	3.085	4.266	4.156	0.352	1.000	0.188	0.407
125-200	1	5.685	1.526	3.261	4.803	4.055	0.445	1.000	0.250	0.819
250-400	1	5.768	2.000	3.500	4.811	4.150	0.433	1.500	0.250	0.764
500-600	1	7.201	2.500	3.465	5.984	4.706	0.562	2.000	0.375	1.201
800-2000	1	6.811	3.500	3.312	5.472	4.962	0.625	2.750	0.500	0.880

1mm = 0.0394" / 1" = 25.4mm

Fig. 1: 35-2000A

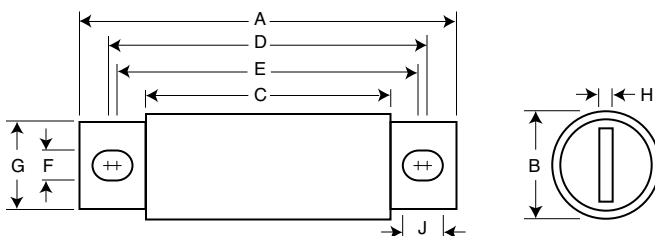

Arc Voltage

This curve gives the peak arc voltage, U_L, which may appear across the fuse during its operation as a function of the applied working voltage, E_g, (rms) at a power factor of 15%.

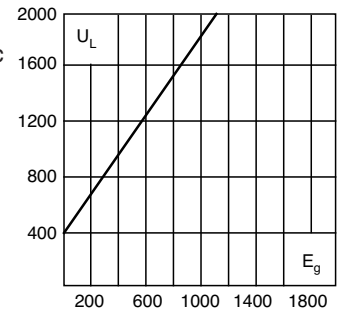

Power Losses

Watts loss at rated current is given in the electrical characteristics. The curve allows the calculation of the power losses at load currents lower than the rated current. The correction factor, K_p, is given as a function of the RMS load current, I_b, in % of the rated current.

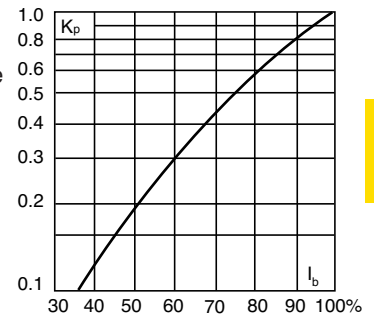

Catalog Numbers

Catalog Numbers	Rated Current RMS-Amps	Electrical Characteristics I ² t (A ² Sec)		Watts Loss
		Pre-arc	Clearing at 1000V	
FWJ-35A	35	210	2000	7
FWJ-40A	40	300	2500	8
FWJ-50A	50	470	3500	10
FWJ-60A	60	670	5000	11
FWJ-70A	70	1100	6900	12
FWJ-80A	80	1550	9700	13
FWJ-90A	90	1900	12000	14
FWJ-100A	100	2800	17500	15
FWJ-125A	125	4800	35000	16
FWJ-150A	150	6300	45000	25
FWJ-175A	175	7500	65000	30
FWJ-200A	200	11700	80000	32
FWJ-250A	250	16000	112000	50
FWJ-300A	300	23500	164000	56
FWJ-350A	350	33000	231000	62
FWJ-400A	400	47000	330000	67
FWJ-500A	500	39500	329000	95
FWJ-600A	600	61000	520000	105
FWJ-800A	800	87000	500000	182
FWJ-1000A	1000	190000	1100000	206
FWJ-1200A	1200	370000	2100000	240
FWJ-1400A	1400	470000	2700000	248
FWJ-1600A	1600	700000	4000000	267
FWJ-1800A	1800	925000	5300000	239
FWJ-2000A	2000	1330000	7600000	244

• Watts loss provided at rated current.
• See accessories on page 113.

Features and Benefits

- Excellent DC performance
- Low arc voltage and low energy let-through (I²t)
- Low watts loss
- Superior cycling capability

Typical Applications

- DC common bus
- DC drives
- Power converters/rectifiers
- Reduced voltage starters

Data Sheet: 720027

North American — FWJ 1000V: 35-2000A

FWJ 35-600A: 1000V

Time-Current Curve

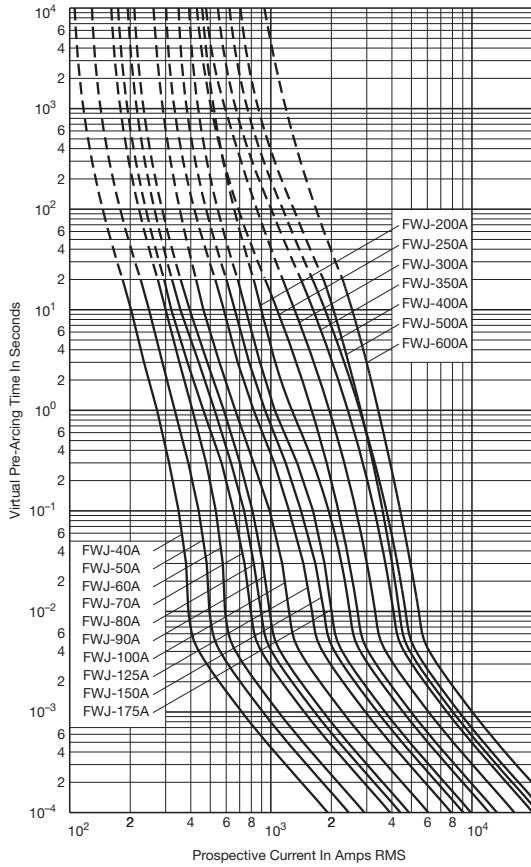

FWJ 800-2000A: 1000V

Time-Current Curve

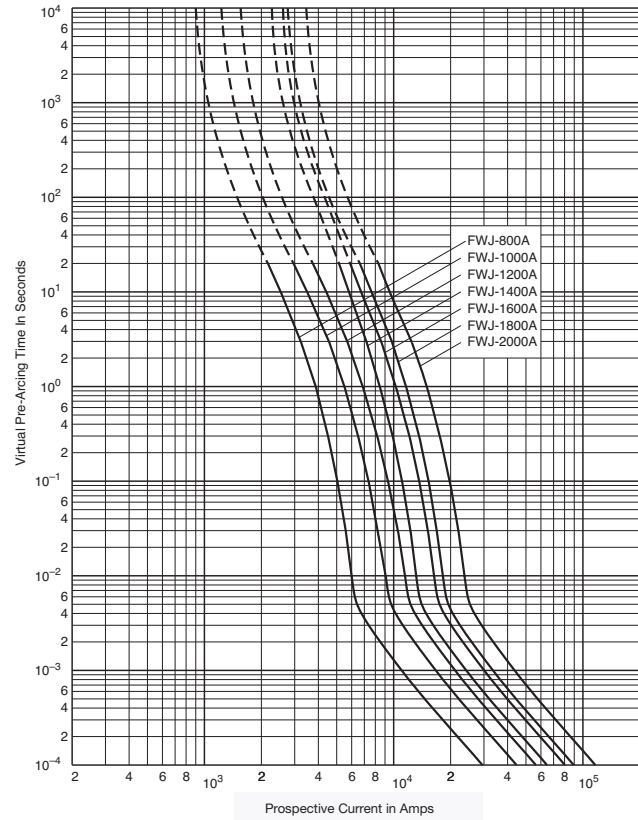

Data Sheet: 35785309

Peak Let-Through Curve

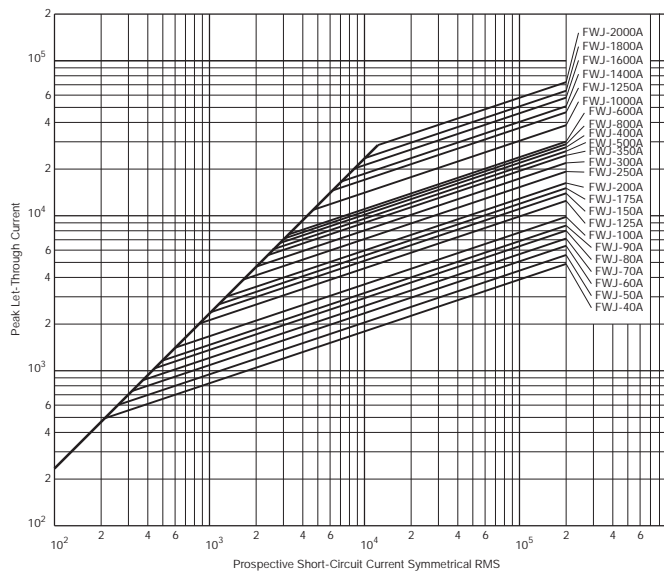

Data Sheet: 35785303

North American Fuse Accessories

Fuse Bases (Blocks)

Modular Style

Cooper Bussmann offers a comprehensive line of fuse bases that provide the user with design and manufacturing flexibility. Two identical half bases make up a Cooper Bussmann® modular fuse base. These “split” units can be panel mounted any distance apart to accommodate any length fuse.

Stud Type (Not sold in pairs)

The simpler design is the C5268 Series modular fuse base. With this design, the fuse terminal and cable (with termination) are mounted on the same stud, minimizing labor needed for installation. The stud type base is available in the configuration shown in the table below.

Catalog Number	Max Fuse Amp Rating	Stud Height (in)	Stud Dia. & Threads
C5268-1	200	1.00	5/16"-18
C5268-2	200	1.75	5/16"-18
C5268-3	200	0.75	5/16"-18
C5268-4	100	1.00	1/4"-20
C5268-5	100	1.75	1/4"-20

Connector Type

Cooper Bussmann also offers a modular style fuse base that utilizes a tin-plated connector (for wire termination and heat dissipation) and a plated-steel stud (for fuse mounting). The connector type fuse base is available in the configurations shown below. Consult Cooper Bussmann for additional product details.

Modular Base Style	Max Voltage	Max Fuse Amp Rating	Data Sheet Number
1BS101	600	100	1206
1BS102	600	400	1207
1BS103	600	400	1208
1BS104	600	600	1209
BH-0xxx	700	100	1200
BH-1xxx	2500	400	1201
BH-2xxx	5000	400	1202
BH-3xxx	1250	700	1203

Refer to page 275 for BH style holders.

Fixed Center Base Style

Cooper Bussmann offers a comprehensive line of fixed mount style fuse bases under the trademark TRON® rectifier fuse blocks. The cable and fuse connections are similar to the stud type fuse base — both are mounted on the same stud. Consult Cooper Bussmann for complete product details.



High Speed Fuses