

NPN General Purpose Transistor

BC848BW / BC848B / BC848C

●Features

- 1) V_{CE0} minimum is 30V ($I_C=1\text{mA}$)
- 2) Complements the BC858B / BC858BW.

●External dimensions (Units : mm)

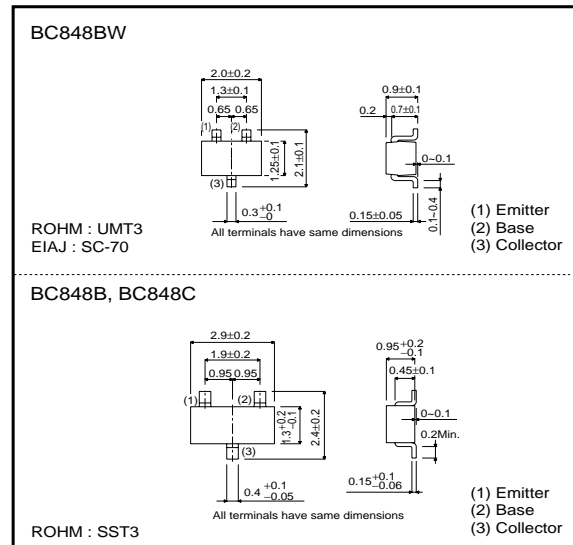

●Absolute maximum ratings ($T_a=25^\circ\text{C}$)

Parameter	Symbol	Limits	Unit
Collector-base voltage	V_{CBO}	30	V
Collector-emitter voltage	V_{CEO}	30	V
Emitter-base voltage	V_{EBO}	5	V
Collector current	I_C	0.1	A
Collector power dissipation	P_C	0.2	W *
		0.35	
Junction temperature	T_j	150	$^\circ\text{C}$
Storage temperature	T_{stg}	-55~+150	$^\circ\text{C}$

* When mounted on a 7×5×0.6mm ceramic board.

●Electrical characteristics ($T_a=25^\circ\text{C}$)

Parameter	Symbol	Min.	Typ.	Max.	Unit	Conditions
Collector-base breakdown voltage	BV_{CBO}	30	—	—	V	$I_C=50\mu\text{A}$
Collector-emitter breakdown voltage	BV_{CEO}	30	—	—	V	$I_C=1\text{mA}$
Emitter-base breakdown voltage	BV_{EBO}	5	—	—	V	$I_E=50\mu\text{A}$
Collector cutoff current	I_{CBO}	—	—	15	μA	$V_{CB}=30\text{V}$
		—	—	5		$V_{CB}=30\text{V}, T_a=150^\circ\text{C}$
Collector-emitter saturation voltage	$V_{CE(sat)}$	—	—	0.25	V	$I_C/I_B=10\text{mA}/0.5\text{mA}$
		—	—	0.6		$I_C/I_B=100\text{mA}/5\text{mA}$
Base-emitter saturation voltage	$V_{BE(on)}$	0.58	—	0.77	V	$V_{CE}/I_C=5\text{V}/10\text{mA}$
DC current transfer ratio	h_{FE}	200	—	450	—	$V_{CE}/I_C=5\text{V}/2\text{mA}$ (BC848B/BW)
		420	—	800		$V_{CE}/I_C=5\text{V}/2\text{mA}$ (BC848C)
Transition frequency	f_T	—	200	—	MHz	$V_{CE}=5\text{V}, I_E=-20\text{mA}, f=100\text{MHz}$
Collector output capacitance	C_{ob}	—	3	—	pF	$V_{CB}=10\text{V}, I_E=0, f=1\text{MHz}$
Collector output capacitance	C_{ib}	—	8	—	pF	$V_{EB}=0.5\text{V}, I_E=0, f=1\text{MHz}$

(SPEC-C22)

Transistors

●Packaging specifications

Part No.	BC848BW	BC848B	BC848C
Packaging type	UMT3	SST3	SST3
Marking	G1K	G1K	G1L
Code	T106	T116	T116
Basic ordering unit (pieces)	3000	3000	3000

●Electrical characteristic curves

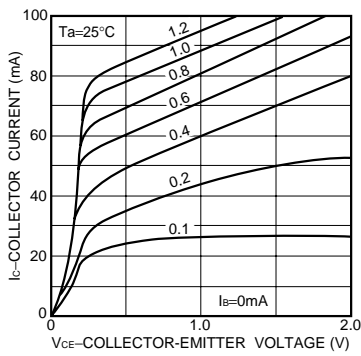

Fig.1 Grounded emitter output characteristics (I)

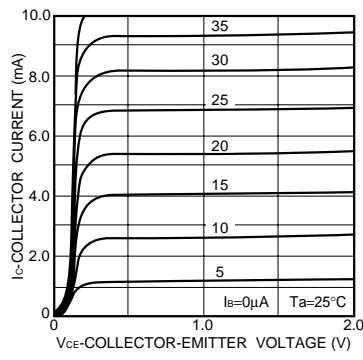

Fig.2 Grounded emitter output characteristics (II)

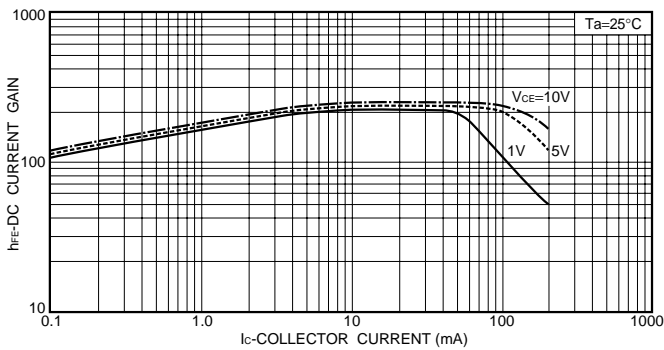

Fig.3 DC current gain vs. collector current (I)

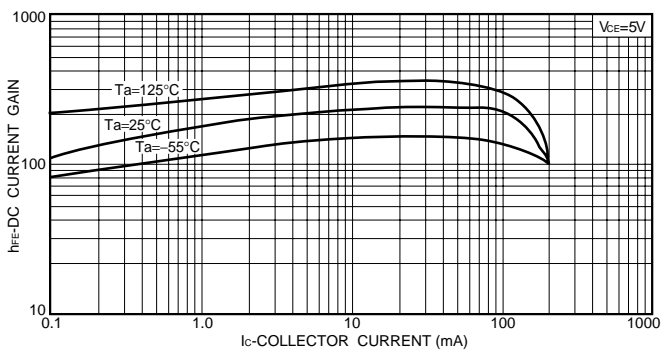

Fig.4 DC current gain vs. collector current (II)

Transistors

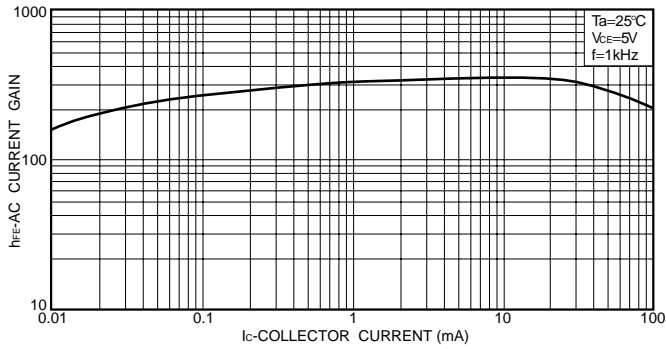

Fig.5 AC current gain vs. collector current

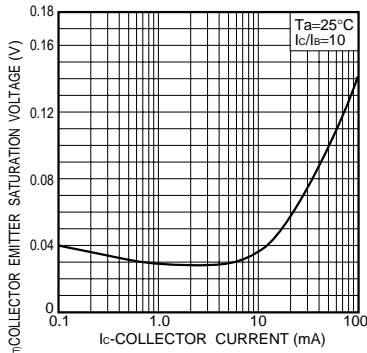

Fig.6 Collector-emitter saturation voltage vs. collector current

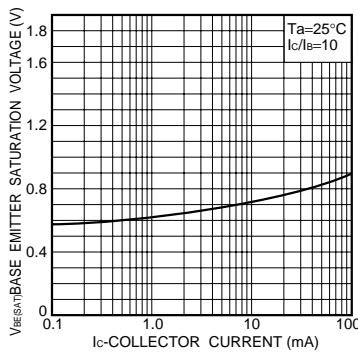

Fig.7 Base-emitter saturation voltage vs. collector current

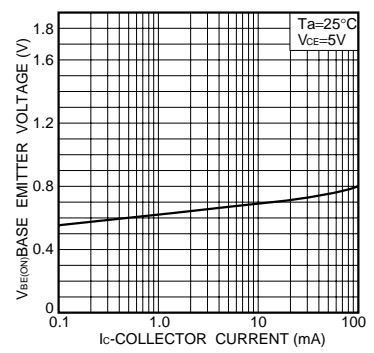

Fig.8 Grounded emitter propagation characteristics

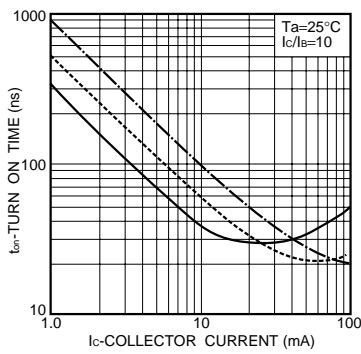

Fig.9 Turn-on time vs. collector current

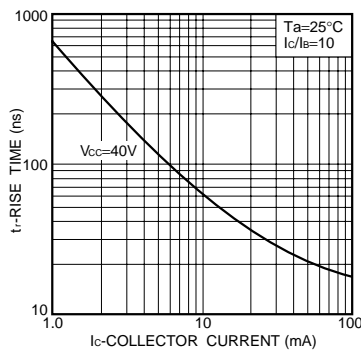

Fig.10 Rise time vs. collector current

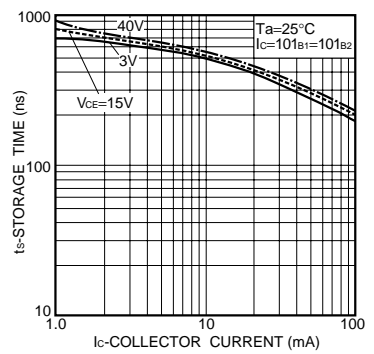

Fig.11 Storage time vs. collector current

Transistors

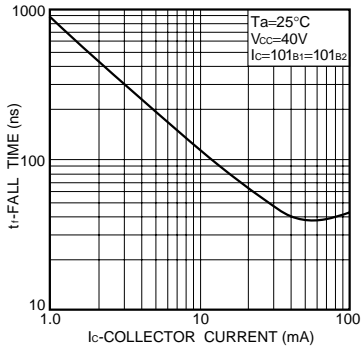

Fig.12 Fall time vs. collector current

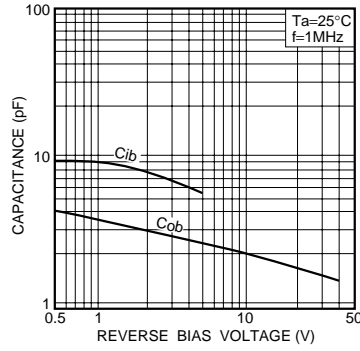

Fig.13 Input/output capacitance vs. voltage

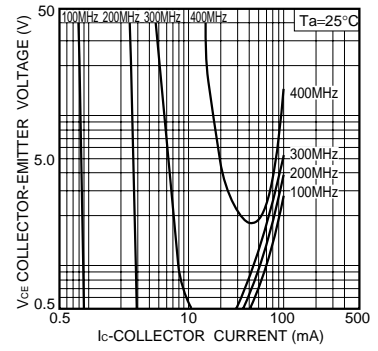

Fig.14 Gain bandwidth product

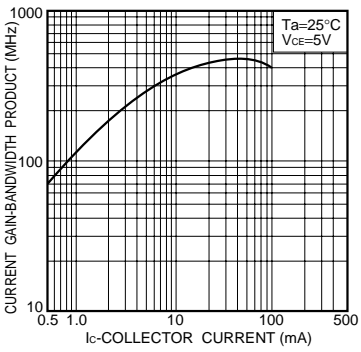

Fig.15 Gain bandwidth product vs. collector current

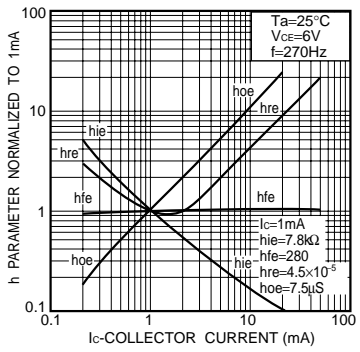

Fig.16 h parameter vs. collector current

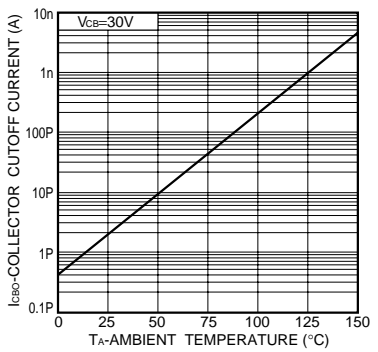

Fig.17 Collector cutoff current

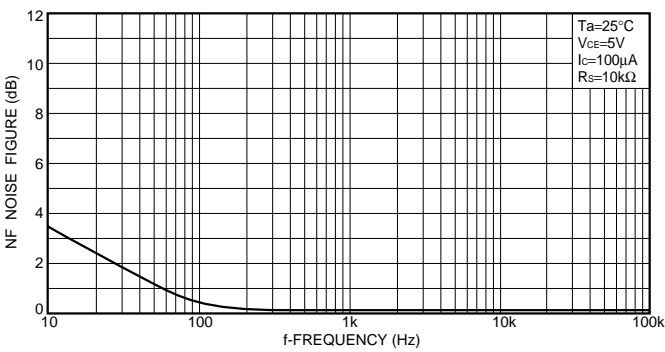

Fig.18 Noise vs. collector current

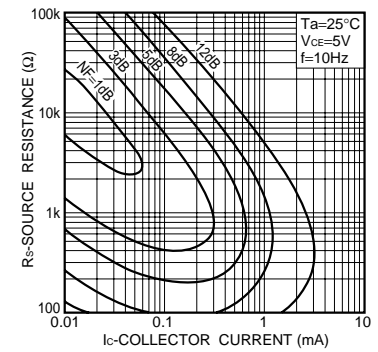

Fig.19 Noise characteristics (I)

Transistors

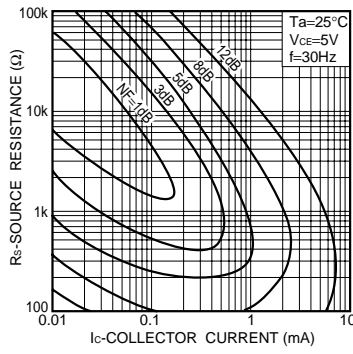

Fig.20 Noise characteristics (II)

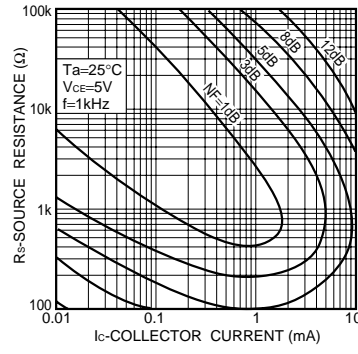

Fig.21 Noise characteristics (III)

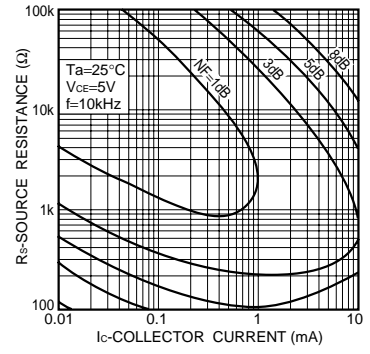

Fig.22 Noise characteristics (IV)