

4		3		2		1	
ITEM	CONNECTOR PART NO.	DESCRIPTION	IPI CHECK	EOR CHECK	Applicable Tooling		
1	RSFR-2-LM	RSF CONNECTOR BLACK HOUSING, W-W			APPLICATOR		
2	SIM-51T-250N	TAB-IN CONTACT – BRASS TIN-PLATED					
3	UL1015, 16 AWG	BLACK					

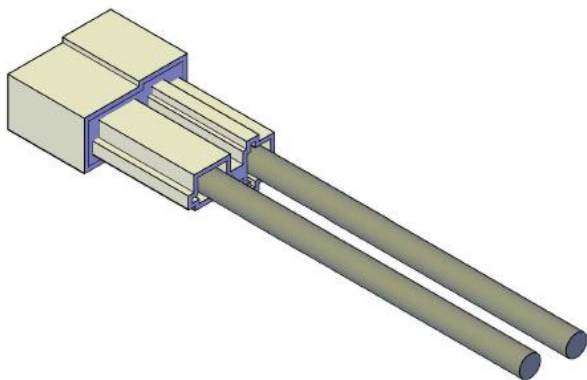
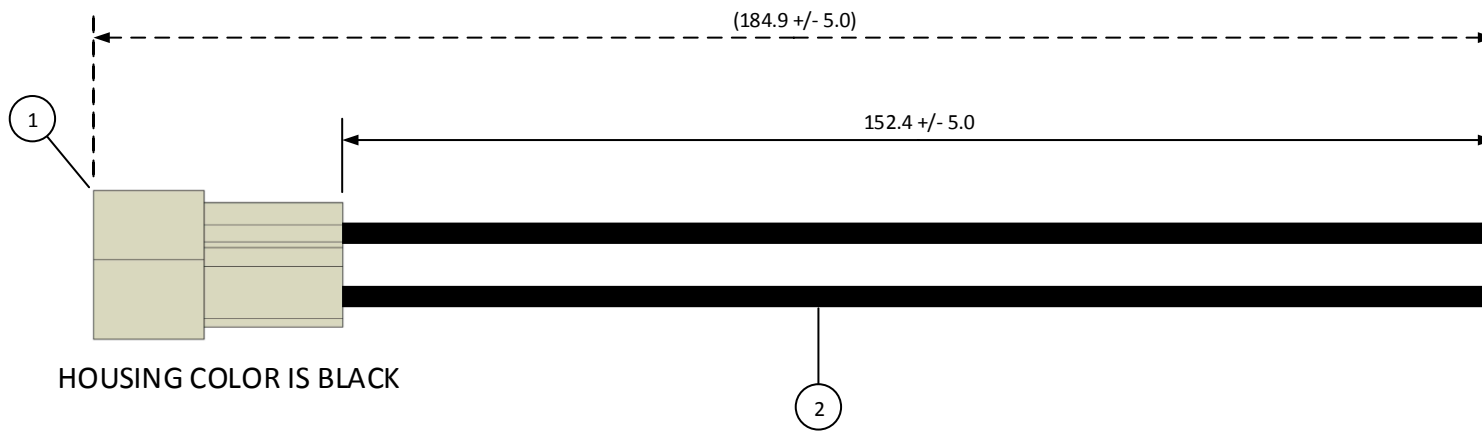

JST

SCALE	CUSTOMER NAME	CUSTOMER PART NO.
1: 1		
DIMENSIONS	DESCRIPTION	
All dimensions are in MM with a tolerance of +/- 3.0 unless otherwise specified.	6" INSIDE LENGTH – 2 POSITION, LIF, POS LOCK, .250, W-W INSULATED RECTPT W/BLUNT LEADS, BLACK HSG MATES W/W-W PLUG 02RSFP16K152K	
DRAWN BY	ASSEMBLY PART NO.	
STEVEN PILKINGTON	A02RSFR16K152K	
CHECKED BY	DRAWING NO. & REVISION	REVISED
JUSTIN BAKER	GAM-143	3/16/2016

REV.	DESCRIPTION	DATE	BY

4 3 2 1