

114-5046

Rev. E1

Application Specification

(取付適用規格)

Terminating AMP MTEI Connector

(マスタ-ミネ-ション EI シ-ズ コネクタの挿入結線の条件)

Following first 7 pages are English version and last 7 pages are Japanese version. This top sheet is not part of the specification but explains both of English and Japanese versions are available.

このトップシートに続く最初の7ページは英語版で、その後の7ページは日本語版です。このトップシートは、規格には含まれませんが、英語、日本語両方があることを説明しています。

114-5046

Application Specification  
Terminating AMP MTEI Connector

NUMBER 114-5046  
Customer Release  
AMP SECURITY CLASSIFICATION

1. Scope:

This specification covers general requirements for terminating AMP MEIS Connectors by means of AMP Wire Displacement technique. These requirements are applicable to the termination performed by using both hand tools and automatic terminating machines. The wires to be used for termination shall comply with the followings with regard to type of wire and conductor sizes.

Applicable Wire Size		Receptacle Housing Assembly	
mm <sup>2</sup>	(AWG)	Standard Type	Feed-Thru Type
0.3-0.35	(#22)	172051	172185
0.2-0.22	(#24)	172052	172186
0.12-0.15	(#26)	172053	172187
0.08-0.09	(#28)	172054	172188

2. Connector Nomenclature:  
(Typical: Standard Type)

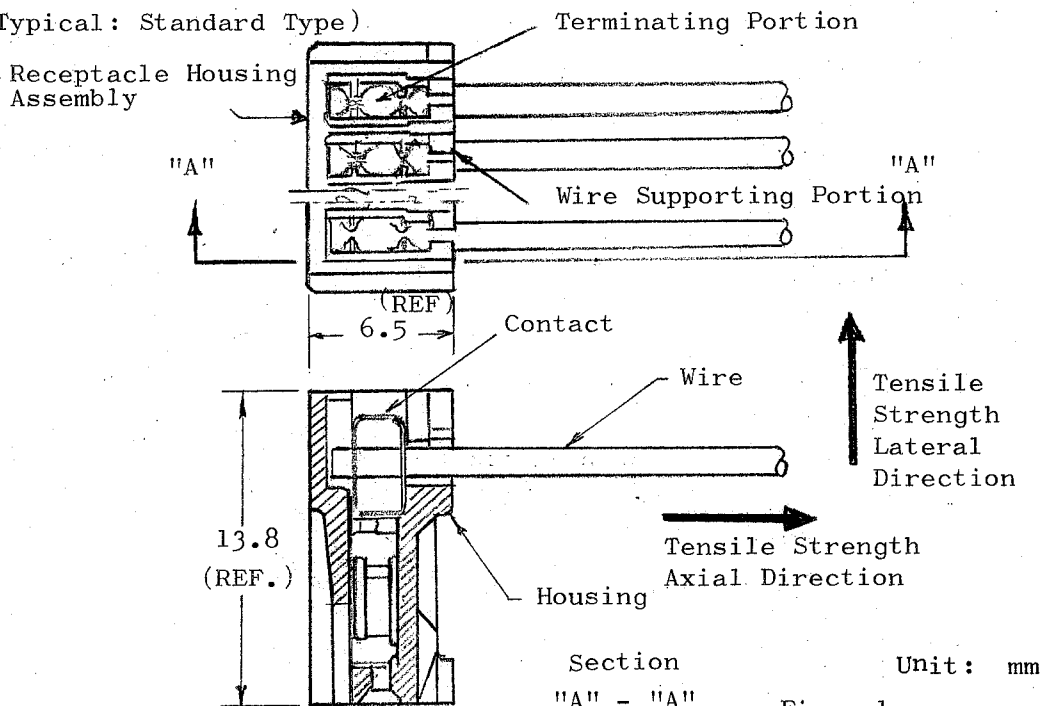

Fig. 1

E	REVISED RFA-1695	7F	SLC	10/80	E1	Revised FJ00-1364	KS/EIC 9/84	 AMP (Japan), Ltd. TOKYO, JAPAN	LOC J NO A 114-5046	REV E1
D	Revised			11/24	DR					
C	Revised per RFA-493			2-80	CHK					
B	Revised			2-80	APP	3-1-78				
A	Revised			2-80						
O	Released per RFA-393			3-79						
LTR	REVISION RECORD	DR	CHK	DATE	SHEET 1 OF 2 NAME Application Specification Terminating AMP Mass-termination "EI" Series Connector					

3. Applicable Wires:

3.1 General Specifications:

Type of Insulation: PVC-insulated Wires  
 Type of Wires: Discrete Wires  
 Ribbon Cables, 2.5mm Center Line,  
 (Extruded and laminated)  
 Ribbon Cables General Purpose  
 Jacket Wires  
 Drain Shielded Wires

Wire Size: AWG #22 (0.3 - 0.35mm<sup>2</sup>)    AWG #26 (0.12 - 0.15mm<sup>2</sup>)  
 AWG #24 (0.2 - 0.22mm<sup>2</sup>)    AWG #28 (0.08 - 0.09mm<sup>2</sup>)

Specifications of Conductors:

Fused-Stranded Wires, Tin-Plated Solid Wire  
 7 Stranded Wires (Tin-plated)

Insulation Diameter: 1.1 - 1.5 mm

3.2 Specification of 2.5mm Center Line Ribbon Cables:

2.5mm center line spacing, ribbon cables of simultaneous extrusion type and laminated type, used for termination, should be "U" notched between the conductors, or slit punched to make cut-outs as shown in the figure 3a below to allow proper fitting to connector housing when terminating.

3.2.1 Dimensional Requirements:

Ribbon cables used for termination shall comply with the requirements of UL Style 2468 or 2877 or equivalent, having dimensions as shown in Fig. 2 below.

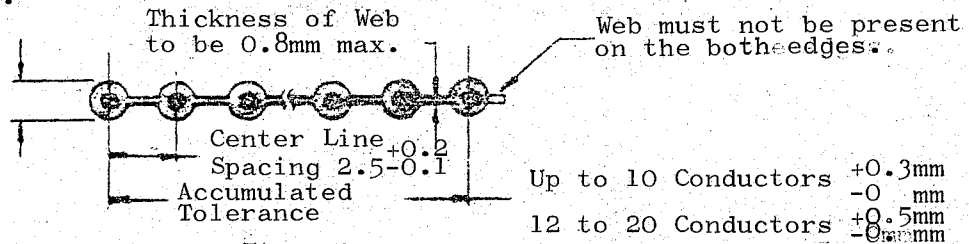

Fig. 2

3.2.2 "U" Cut Slit Dimensions:

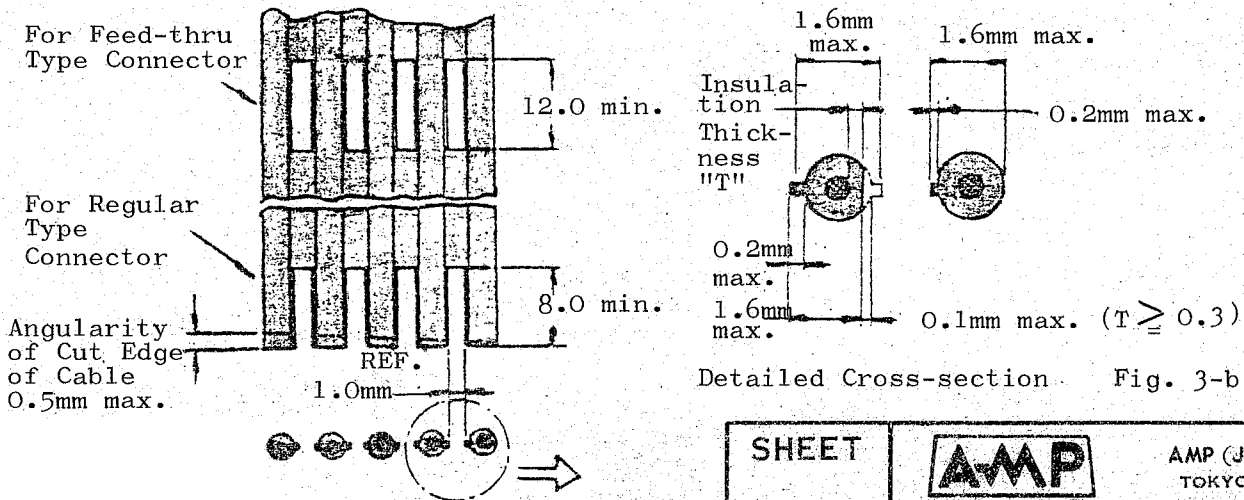

Fig. 3-a

Detailed Cross-section Fig. 3-b

SHEET		<b>AMP</b>		AMP (Japan), Ltd. TOKYO, JAPAN	
2 OF 7	LOC J A	NO	114-5046	REV	E
NAME Application Specification Terminating AMP Mass-termination "EI" Series Connector					

3.3 Requirements for General Purpose Ribbon Cables:

Applicable connector assembly to be terminated: Regular Type only

Preparation: Slit cut-outs shall be made between the conductors to the length as specified in Fig. 4.

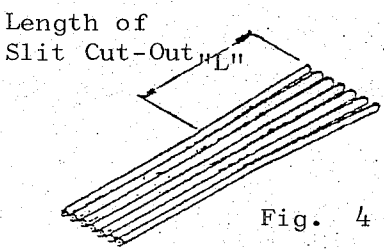

Fig. 4

- Up to 6 Conductors: 45mm min.
- L : 7 to 12 Conductors: 50mm min.
- 13 to 20 Conductors: 60mm min.

"L" dimension includes extra allowance of 15mm required for shearing with the use of mini-press assembly.

3.4 Requirements for Jacket Wires:

Applicable connector assembly to be terminated: Regular type only

Preparation: Stripping of shield sheath must be made to the length specified in Fig. 5.

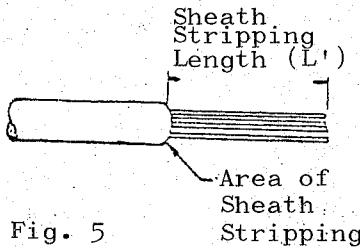

Fig. 5

- Up to 10 Conductors: 60mm min.
- L' = 11 Conductors and over: 80mm min.

"L'" dimension includes extra allowance of 20mm required for shearing with the use of mini-press assembly.

3.5 Requirements for Drain Shield Cables:

Applicable connector assembly to be terminated: Regular type only

Preparation: Stripping of shield sheath must be made to the length specified in Fig. 6-a and Fig. 6-b.

(1) General Purpose Shielded Wire with Drain (Ground) Wire:

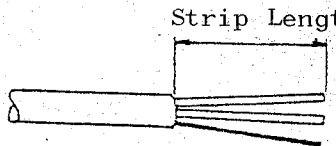

Fig. 6-a

- "L'''' = 45mm min.
- "L'''' dimension includes extra allowance of 15 mm required for shearing with the use of mini-press assembly.

Drain wire: Tin-plated solid wire or tin-plated stranded wire (The wire without insulation must use insulation sleeve)

(2) 25mm Center Line Spacing, Electric-conductive Plastics Shielded Wire:

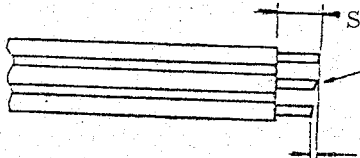

Fig. 6-b

Stripping Length (L) = 8mm min.

Drain Wire: Bare Solid Wire (Tin-plated solid wire of tin plated stranded wire) must be sleeve insulated.

Uniformity of cut length to be within 0.5mm.

SHEET		<b>AMP</b>		AMP (Japan), Ltd.	
3 OF 7				TOKYO, JAPAN	
LOC	J	NO	A	114-5046	REV
				E	
NAME Application Specification					
Terminating AMP Mass-termination					
"EI" Series Connector					

4. Specified Requirements:

Dimensions, functional performance and appearance of the connector assembly after termination shall be conforming to the following requirements.

4.1 Terminated Feature:

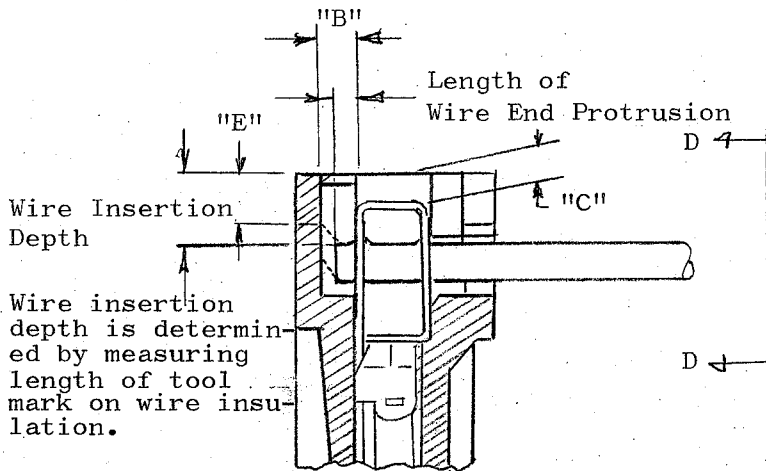

FIG. 2 - a

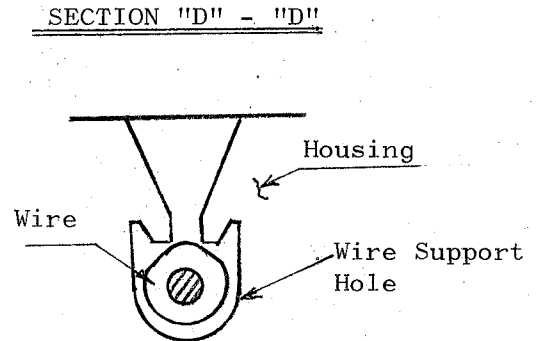

FIG. 2 - b

4.1.1 Wire Insertion Depth:

Wire shall be inserted into the contact slot to a depth of  $2.6^{+0.1}_{-0.3}$  mm, regardless of the wire size and insulation diameter of the wire used, when measured from the top surface of housing to upper end of bottomed wire insulation, as shown in Fig. 2-a. Measurement shall be done at the portion of wire end protrusion.

4.1.2 Wire End Protrusion Length:

Wire end protrusion length shall be not less than 50% of B dimension (0.6mm min.) that spans between front contact end and inside cavity wall at front end. Wire front end must bottom to a depth of 1 mm min. when measured from top of housing.

4.1.3 Wire Support Portion:

Wire end shall be fully bottomed into the contact slot, when inserted as shown in Fig. 2 - b. However, a slight flow-up of the wire from the bottom resulted from elongation of wire insulation can be permissible so long as the terminated wire can withstand lateral pull-off load specified in Para. 3.3., as shown in Fig. 3.

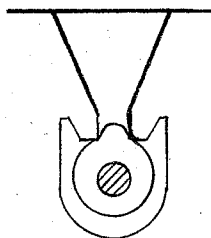

FIG. 3

SHEET		<b>AMP</b>		AMP (Japan), Ltd. TOKYO, JAPAN	
<u>4</u> OF <u>7</u>	LOC <b>J A</b>	NO 114-5046	REV E		
NAME Application Specification Terminating AMP Mass-termination "EI" Series Connector					

4.1.4 Contact Lodging Location in Housing:

Contact shall be lodged in correct location in housing after termination is completed, and the Dimension "C" shall not exceed 1.4mm when measured between upper surface of contact and connector upper edge as shown in Fig. 2 - a.

4.2 Appearance:

4.2.1 Wire:

Terminated wire shall be free from the evidence of undue cut and damages that are detrimental to connector functions.

4.2.2 Housing:

Connector housing shall show no evidence of damages that are detrimental to connector functions after termination.

4.2.3 Terminated contacts shall show no evidence of abnormalities such as breakage of wire at terminated area, deformation and damages that are detrimental to connector function. A slight bend down of contact upper frame in one side only can be permissible when not excessive and not being broken off. The permissible level of deformation is shown in Fig. 4.

For details of acceptance criteria, refer to the charts in sheets 4 and 5.

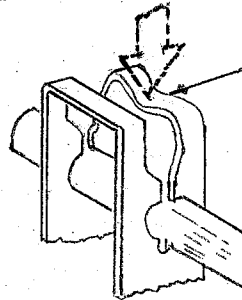

A slight deformation can be permissible, so long as the wire conductor is not damaged or broken.

FIG. 4

4.3 Tensile Strength of Terminated Wire:

Terminated wire shall withstand a pull-off load in either axial or lateral direction to meet the specified value as shown in Table 1.

Wire Size		Pull-Off Load			
mm <sup>2</sup>	(AWG)	Axial Direction (Min.)		Lateral Direction (Min.)	
		kg	(lbs.)	kg	(lbs.)
0.3	(#22)	44.1N (4.5Kgf)	(9.92)	19.6N (2Kgf)	(4.41) Wire O.D. 1.3ø (Min.)
0.2	(#24)	34.3N (3.5Kgf)	(7.72)		" " " "
0.13	(#26)	24.5N (2.5Kgf)	(5.51)	14.7N (1.5Kgf)	(3.31) " " 1.2ø (Min.)
0.08	(#28)	14.7N (1.5Kgf)	(3.31)	9.8N (1Kgf)	(2.20) " " 1.1ø (Min.)

Table 1











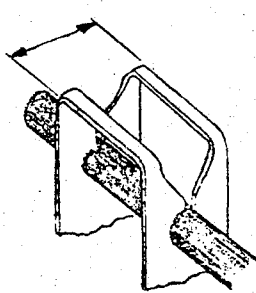

Tensile strength of the wires other than specified for testing lateral load shall be not less than 9.8N (1Kgf).

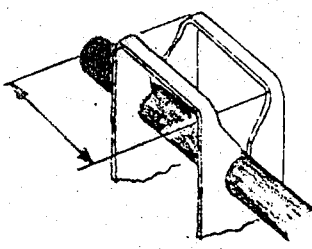
SHEET		<b>AMP</b>		AMP (Japan), Ltd.	
5 OF 7				TOKYO, JAPAN	
LOC	J A	NO	114-5046	REV	E
NAME Application Specification Terminating AMP Mass-termination "EI" Series Connector					

Acceptance Criteria on Deviated Termination

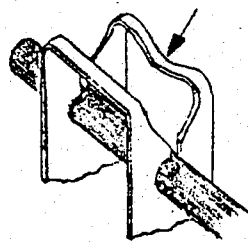
Part 1: Deformation of Contact

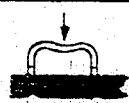
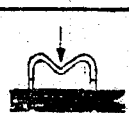
NUMBER 114-5046  
 Customer Release  
 AMP SECURITY CLASSIFICATION

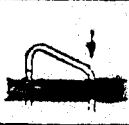
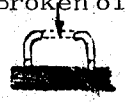
Check Points	Requirements	OK or NG	Appearance	Descriptions of Formed Shape
1 	Shoulders must appear parallel after termination.	○	Parallel 	Normal without deformation
		X		Bent inward, one side only or both sides
				Bent outward, one side only or both sides
2 	Wire lead-in area must appear flush one another after termination.	○		Normal without deformation
		X		Wire lead-in area, bent down inward, one side only "a" dim. is less than stock thickness (0.25mm)
				Wire lead-in area, bent down inward, one side only "b" dim. is equal or larger than stock thickness (0.25mm)
3 	Terminated contact shall appear normal without breakage of wire by undue affection of application tooling.	○		Normal without deformation
				Shoulder, bent down slightly, one or two sides. Degree of deformation: A
				Shoulder, bent down remarkably, one or two sides. Degree of Deformation: B
		X		Tool Mark Shoulder, damaged by tooling interference with partial bend-down, one side only, Degree of Deformation: C
				Strain relief slot area, falling down, one side only. Refer to Para. 3.1.4. Degree of Deformation: D
				Shoulder, broken off Degree of Deformation: E
			Broken off	

SHEET				AMP (Japan), Ltd. TOKYO, JAPAN	
6	OF 7			LOG	J A
		REV	E		
NAME Application Specification					
Terminating AMP Mass-termination "EI" Series Connector					

Part 2:

Deviated Insulation Overflow from Wire Lead-in Slot

114-5046

NUMBER

CUSTOMER Release

AMP SECURITY CLASSIFICATION

Check Item	Status	OK or NG	Status of Terminated Area Classified by Wire Sizes				
			O.D. of Insulation 1.2 mm Min. (REF.: AWG#28-#26)	O.D. of Insulation 1.2mm Max. and 1.4mm Min. (REF.: #26-#24)	O.D. of Insulation 1.4mm Min. (REF: #24-#22) & 2.5mm CTR Ribbon Cables		
	Normal	○	<p>Insulation clears wire lead-in area.</p>	<p>Insulation piles up symmetrically over wire slot.</p>	<p>Insulation coverage appears symmetrical in wire lead-in area with tool mark at the center of wire.</p>		
			Abnormal	○	<p>Wire lead-in areas are partly covered with insulation. Uncovered area is visible in the area 0.25mm minimum.</p> <p>0.25 mm Min.</p>	<p>Wire lead-in areas are partly covered with insulation. Uncovered area is visible in the area less than 0.25mm as shown.</p>	<p>Tool mark must be visible. Wire lead-in areas are covered partly with insulation.</p> <p>Tool mark must appear at the point 1/2 of wire width or greater.</p> <p>W</p> <p>Visible Wire Width</p>
					X	○	<p>Wire lead-in areas are covered with insulation and not visible sufficiently. Uncovered area is not wider than 0.25mm.</p> <p>Less than 0.25mm</p>

SHEET



AMP (Japan), Ltd. TOKYO, JAPAN

7 OF 7

LOC J A

NO 114-5046

REV E

NAME Application Specification Terminating AMP Mass-termination "EI" Series Connector



一般顧客用  
管理基準

# 社内標準

(製造標準)

# AMP

日本エー・エム・ピー株式会社

適用事業所

全社

## Application Specification

取付適用規格

114-5046

マスターミネーションE.Iシリーズ・コネクタの挿入結線の条件

### Terminating AMP MTEI Connector

#### 1. 適用範囲

本規格はマスターミネーションE.Iシリーズ・コネクタのスロット挿入結線の必要条件について規定する。

この条件は結線が手動工具又は自動機による場合の双方に適用され、使用される電線の種類、サイズ等は、3項に規定する範囲のものとする。

対象製品型番

適用電線サイズ	リセハウジングアセンブリー	
	標準タイプ	フィードスルータイプ
AWG #22	172051	172185
AWG #24	172052	172186
AWG #26	172053	172187
AWG #28	172054	172188

#### 2. 部品名称

(図示：標準タイプ)



図-1

"A" - "A" 断面

E1 改訂 FJ00-1364 KS KK 2015.8.9

D	改訂 RFA-504	NO	OK	OK	1/15/81	E	改訂 RFA-1695	J.F.S. 1/2/79
C	改訂 RFA-493	NO	OK	OK	3/19/81	作成:		分類: 取付適用規格
B	改訂	NO	OK	OK	1/12/79	検閲:	N. O'Connell 2/5/79	コード: 改訂
A	改訂	NO	OK	OK	7/31/79	承認:	ckhie 2/26/79	114-5046 E1
0	作成 RFA-393	NO	OK	OK	2/26/79	承認:		名称: マスターミネーションE.Iシリーズコネクタの挿入結線の条件
改訂	改訂記録	作成	検閲	承認	年月日	承認:		
昭和 54年 2月 26日 制定				1 頁				
				7 頁中				

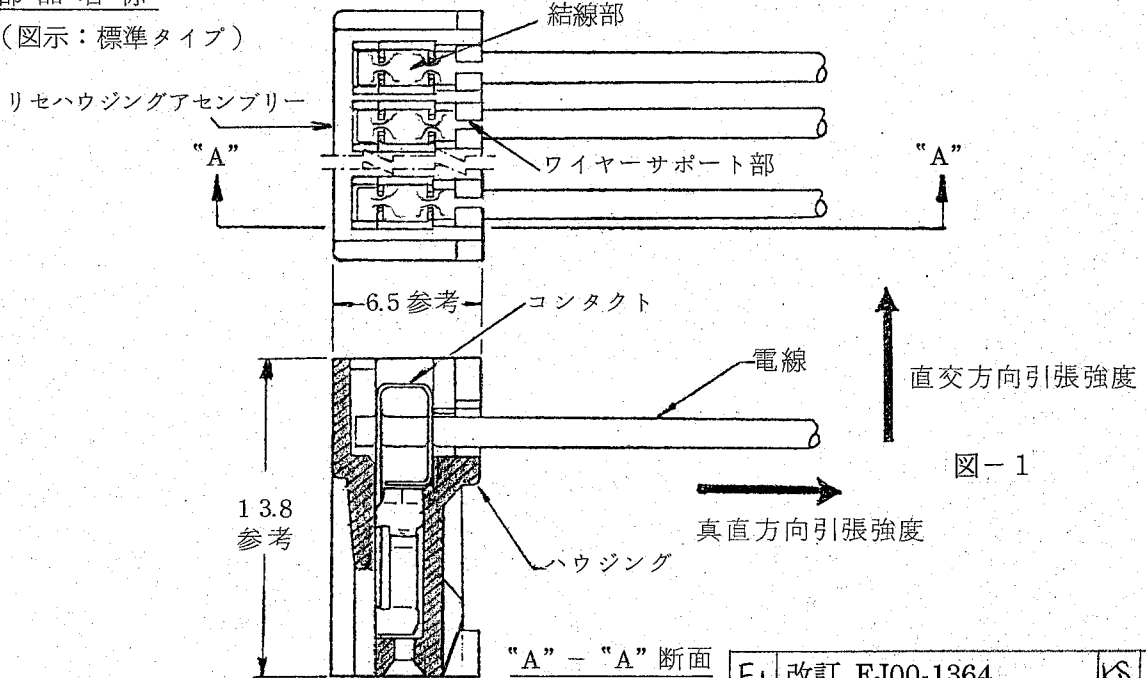
3. 適用電線

3.1 一般適用仕様

種類：PVC絶縁電線

形体： ディスクリット電線  
 { 2.5mmピッチリボン電線（同時押し、ラミネート）  
 一般リボン電線  
 ジャケット電線  
 ドレインシールド電線

電線サイズ：AWG #22 (0.3~0.35 mm<sup>2</sup>)      AWG #26 (0.12~0.15 mm<sup>2</sup>)

AWG #24 (0.2~0.22 mm<sup>2</sup>)      AWG #28 (0.08~0.09 mm<sup>2</sup>)

導体仕様：錫コーティング撚線，単線（錫めっき付），7本撚線（錫めっき付）

絶縁被覆外径：1.1 mm φ ~ 1.5 mm φ

3.2 2.5mmピッチリボン電線の適用仕様

2.5mmピッチの同時押しタイプ及びラミネートタイプリボン電線は，結線位置に“U”カット（巾スリット）加工を施したものの適用を原則としており下記に規定する仕様寸法のもの適用条件とする。

3.2.1 対象：ULスタイル2468又は2877に準拠，あるいは類似するもので下図の仕様寸法を満足のもの。



図2

3.2.2 “U”カット（巾スリット）加工仕様

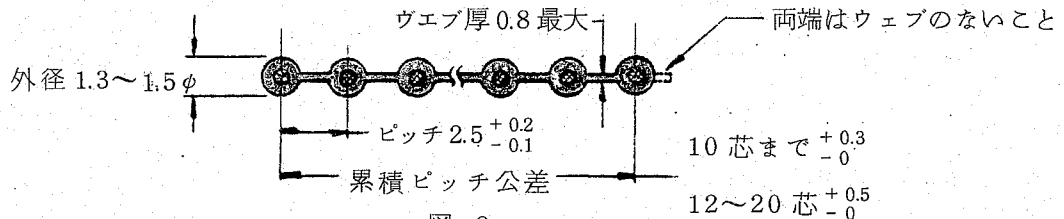

図3-a

図3-b

分類： 取付適用規格	標準の名称： マスターミネーションE.Iシリーズ コネクタの挿入結線の条件	標準のコード： 114-5046	改訂 E1	2頁 7頁中
---------------	---	---------------------	----------	-----------

3.3 一般リボン電線の適用仕様

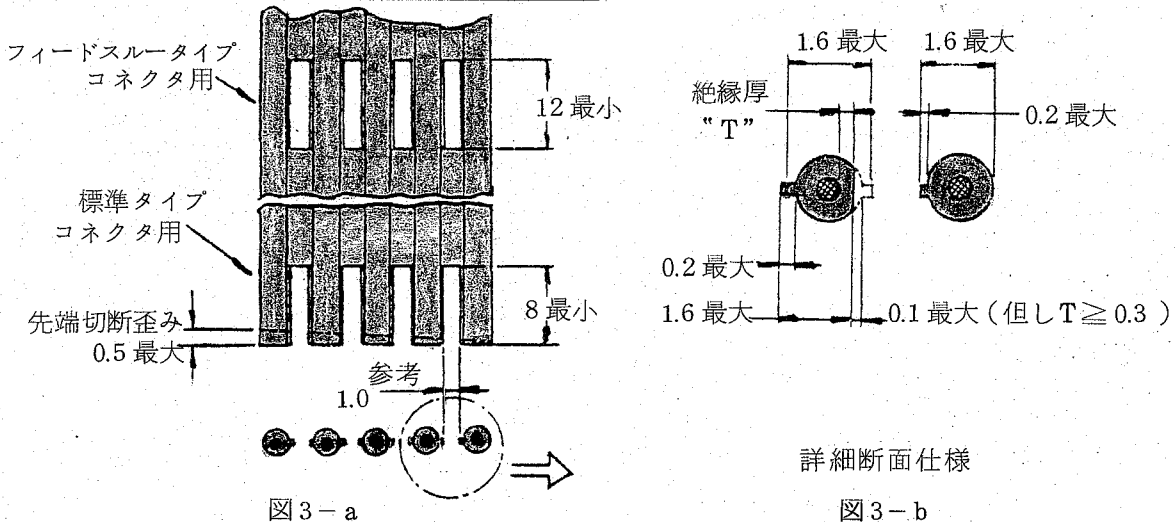
使用コネクタ：標準タイプのみ

電線仕様：結線側端末に指定長さのスリット加工を施すこと。(図4)



図 4

L :	芯線 6 芯以下	45 mm 以上
	7 ~ 12 芯	50 mm 以上
	13 ~ 20 芯	60 mm 以上

(注)：L寸法はミニプレス使用時の先端切断代 15 mm を含む

3.4 ジャケット電線の適用仕様

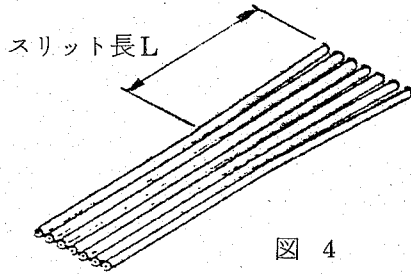
使用コネクタ：標準タイプのみ

電線仕様：シース(外被)径 5 ~ 8 mm

結線側端末は指定長さのシース(外被)むきを施すこと。(図5)



図 5

l :	芯線 10 芯以下	60 mm 以上
	11 芯以上	80 mm 以上

(注)：l寸法はミニプレス使用時の先端切断代 20 mm を含む

3.5 ドレインシールド電線の適用仕様

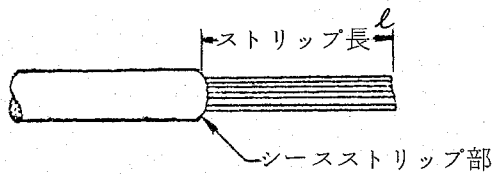
使用コネクタ：標準タイプのみ

電線仕様：結線側端末は指定長さのシース(外被)むきを施すこと。(図6-a, 6-b)

(1) ドレイン(接地)線付一般シールド電線



図 6-a

l = 45 mm 以上

但しミニプレス使用時の先端切断代 15 mm を含む

ドレイン線：錫めっき付単線又は錫コーティング撚線(絶縁被覆なしのものは絶縁スリーブをかぶせる)

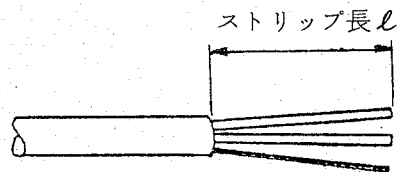
(2) 2.5 mm ピッチ導電プラスチックシールド線



図 6-b

#### 4. 必要条件

結線後の寸法、性能及び外観上の必要条件を規定する。

##### 4.1 結線状態

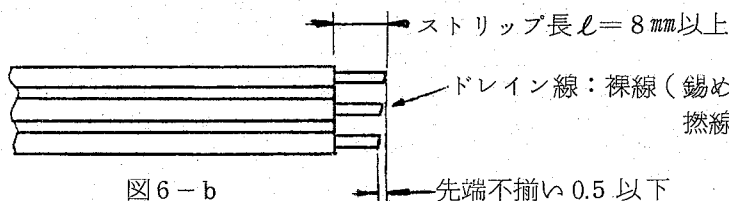

図 7 - a



図 7 - b

##### 4.1.1 電線挿入深さ

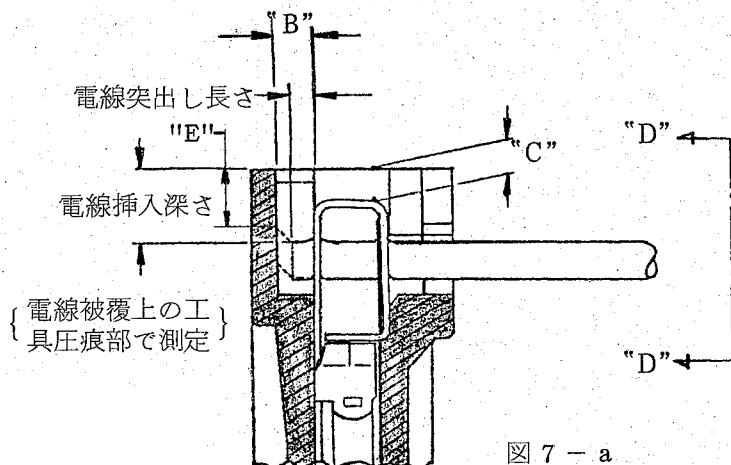
電線の挿入は電線サイズ及び絶縁被覆外径とは関係なく、図 7 - a に示したハウジング上端から電線被覆上の工具圧痕部までの寸法は  $2.6^{+0.1}_{-0.3}$  の範囲内であること。

##### 4.1.2 電線突出し長さ

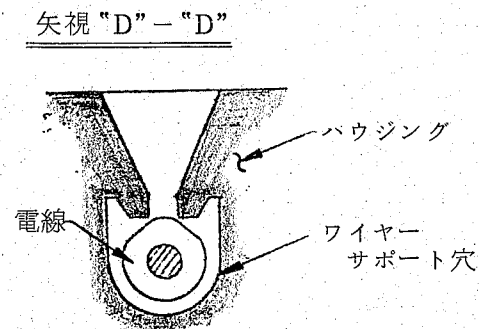
結線された電線の先端部突出し長さは図 7 - a に示したコンタクト・スロット部とハウジング内壁間の寸法 "B" の 50% 以上 (0.6 mm 以上) であること。また電線の先端位置はハウジング上端からの深さ "E" 寸法が 1 mm 以上でなければならない。

##### 4.1.3 ワイヤーサポート部

結線された電線は図 7 - b に示したハウジングのワイヤーサポート穴に完全に挿入されていること。但し電線被覆の伸びによる下図の状態は性能上支障のない範囲 (3.3 項直交方向張強度を満足のこと) で許容する。

##### 4.1.4 コンタクトの位置づけ

電線の挿入結線後のコンタクト位置は図 7 - a に示したハウジング上端からコンタクト端末までの寸法 "C" が 1.4 mm を越えてはならない。



図 8

分類： 取付適用規格	標準の名称： マスターミネーション E.I シリーズ コネクタの挿入結線の条件	標準のコード： 114-5046	改訂 E1	4 頁 7 頁中
---------------	---	---------------------	----------	-------------

4.2 外 観

4.2.1 電 線

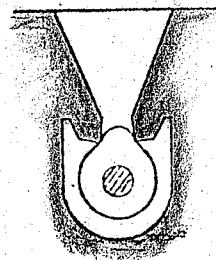
接続された電線は結線部を除いたその被覆外径部に機能上及び性能上支障となるような切り傷等の損傷の形跡が認められてはならない。

4.2.2 ハウジング

結線を終了したコネクタは、ハウジングに機能上及び性能上支障となるような損傷の形跡が認められてはならない。

4.2.3 コンタクト

結線を終了したコネクタは、コンタクトの結線部に機能上及び性能上支障となるような破断や圧縮変形等損傷の形跡が認められてはならない。  
但し、下図に示す範囲の変形は許容される。



図 9

4.3 電線引張強度





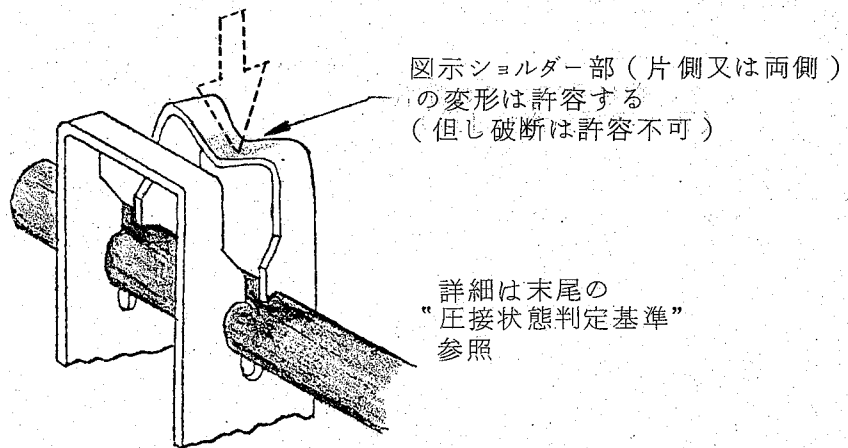





適合する電線サイズ用のコネクタに挿入結線された電線の引張強度は図1に示した真直方向荷重及び直交方向荷重の各々に対して下表の規定値を満足すること。

電線サイズ	真直方向	直 交 方 向 (注)
AWG #22	44.1N (4.5kgf)以上	19.6N (2kgf)以上 (電線被覆外径φ1.3以上)
AWG #24	34.3N (3.5kgf)以上	
AWG #26	24.5N (2.5kgf)以上	14.7N (1.5kgf)以上 ( " φ1.2以上)
AWG #28	14.7N (1.5kgf)以上	9.8N (1kgf)以上 ( " φ1.1以上)

(注) 直交方向引張強度は表中に指定された電線被覆外径寸法のものに適用し指定範囲外のものについては 9.8N 以上であること。  
(1kgf)

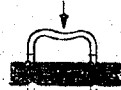
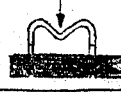
圧接状態判定基準

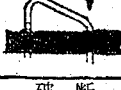
1. コンタクト変形状態

項目	必要条件	許容可否	外観	変形内容
①	平行であること	○		正常状態（変形なし）
		×		内側に変形（片側及び両側）
				外側に変形（片側及び両側）
②	スロット部の左右が段違いにならないこと。	○		正常状態（変形なし）
		×		スロット部の左右が段違いに変形 $a < \text{コンタクト板厚}(0.25)$
				スロット部の左右が段違いに変形 $b \geq \text{コンタクト板厚}(0.25)$
③	工具による破断のないこと。	○		正常状態（変形なし）
				変形度 A 円弧状に変形（片側又は両側）
				変形度 B 中心部下垂変形（片側又は両側）
		工具との干渉疵		変形度 C 工具による干渉疵変形（片側のみ）
		×		変形度 D（4.1.4 項適用） ストレイン・リリース スロット部が沈下
				変形度 E 破断





分類： 取付適用規格

標準の名称：  
マスターミネーション E.I シリーズ  
コネクタの挿入結線の条件

標準のコード：  
114-5046

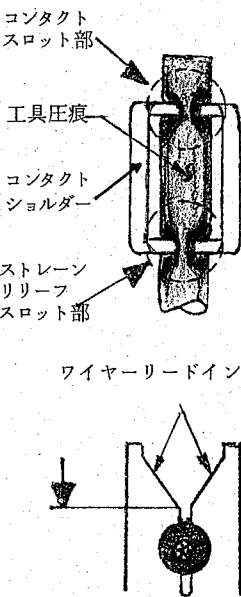
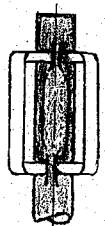
改訂 E1 6 頁  
7 頁中

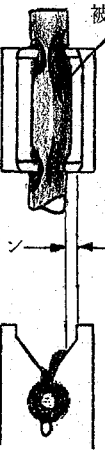
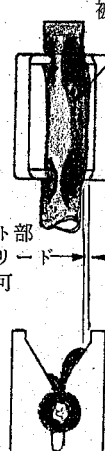
2. 結線部電線被覆状態

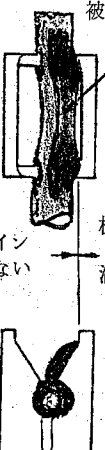
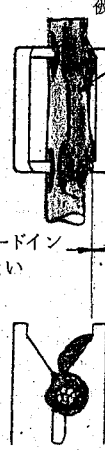
項目及び要件	結線状態	許容可否	電線仕様別外觀状態			
			被覆外径 $\leq 1.2\phi$ (参考: AWG #28-#26)	$1.2\phi < \text{被覆外径} \leq 1.4\phi$ (参考: AWG #26-#24)	$1.4 < \text{被覆外径}$ (参考 AWG #24-#22) 及び 2.5ピッチリボン電線	
<p>下図に示した各部の状態が電線仕様別に規定された右図の範囲内にあること。</p> 	<p>正 常</p>	<p>○</p>	 <p>電線被覆がリードイン部を通過</p>	 <p>リードイン部の被覆の盛り上がりが左右均等</p>	 <p>被覆かぶりが左右均等 (工具圧痕が電線の中心にある)</p>	
			<p>○ (良品限度)</p>			
			<p>芯ずれ及び被覆の片寄り</p>	<p>×</p>		

分類： 取付適用規格

標準の名称： マスターミネーション E.I シリーズ  
コネクタの挿入結線の条件

標準のコード： 114-5046

改訂 7 頁  
E1 7 頁中