

### Typical Applications

The HMC626LP5(E) is ideal for:

- IF & RF Applications
- Cellular/3G Infrastructure
- WiBro / WiMAX / 4G
- Microwave Radio & VSAT
- Test Equipment and Sensors

### Features

- +8.5 dB to +40 dB Gain Control in 0.5 dB Steps
- High Output IP3: +36 dBm
- ±0.25 dB Typical Gain Step Error
- Single +5V Supply
- 32 Lead 5x5mm SMT Package: 25mm<sup>2</sup>

### Functional Diagram

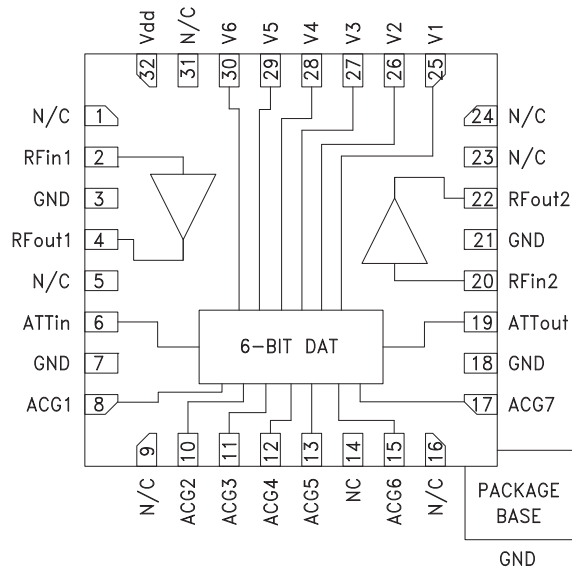

### General Description

The HMC626LP5(E) is a digitally controlled variable gain amplifier which operates from DC to 1 GHz, and can be programmed to provide anywhere from 8.5 dB, to 40 dB of gain, in 0.5 dB steps. The HMC626LP5(E) delivers noise figure of 2.8 dB in its maximum gain state, with output IP3 of up to +36 dBm in any state. This single positive control line per bit digital VGA incorporates off chip AC ground capacitors for near DC operation, making it suitable for a wide variety of RF and IF applications. The HMC626LP5(E) is housed in a RoHS compliant 5x5 mm QFN leadless package, and requires no external matching components. A serial control version of this product is available as the HMC681LP5(E).

### Electrical Specifications, $T_A = +25^\circ C$ , $V_{dd} = V_s = +5V$ , $V_{ctl} = 0 / +5V$

Parameter	Frequency	Min.	Typ.	Max.	Units
Gain (Maximum Gain State)	DC - 0.5 GHz	37	42.5		dB
	0.5 - 1.0 GHz	30	35.0		dB
Gain Control Range			31.5		dB
Input Return Loss			20		dB
Output Return Loss			15		dB
Gain Setting Accuracy: (Referenced to Maximum Gain State) All Gain States	0.5 - 1.0 GHz	± (0.15 + 3% of Relative Gain Setting) Max.			dB
Output Power for 1 dB Compression	DC - 1.0 GHz		20		dBm
Output Third Order Intercept Point (Two-Tone Output Power= 5 dBm Each Tone)	DC - 1.0 GHz		36		dBm
Noise Figure	DC - 1.0 GHz		2.8		dB
Switching Characteristics					
tRISE, tFALL (10/90% RF)	DC - 1.0 GHz		130		ns
tON, tOFF (50% CTL to 10/90% RF)			140		ns
Total Supply Current	DC - 1.0 GHz		176	225	mA

## 0.5 dB LSB GaAs MMIC 6-BIT DIGITAL VARIABLE GAIN AMPLIFIER, DC - 1 GHz

**Gain vs. Frequency<sup>[1]</sup>**

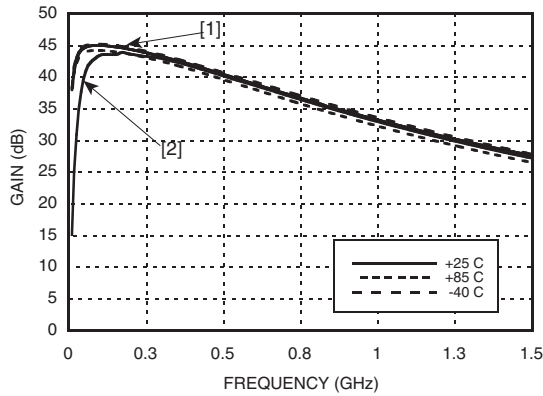

**Relative Gain Setting**

(Referenced to Maximum Gain State)  
(Only Major States are Shown)

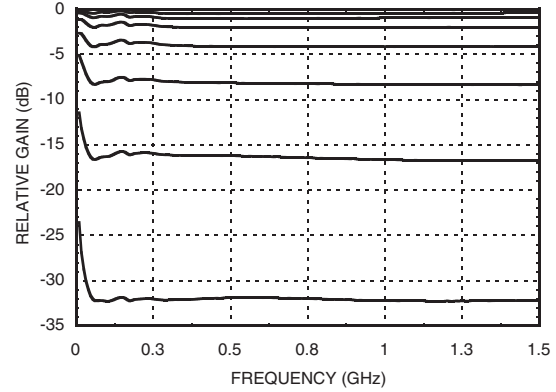

**Input Return Loss<sup>[1]</sup>**

(Only Major States are Shown)

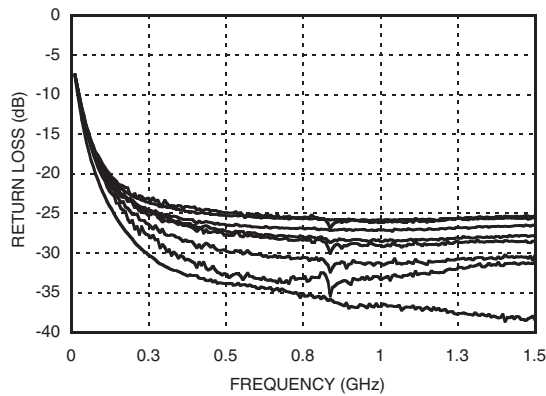

**Output Return Loss<sup>[1]</sup>**

(Only Major States are Shown)

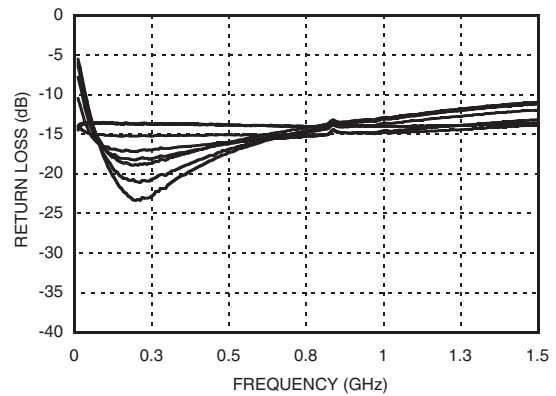

**Input Return Loss<sup>[2]</sup>**

(Only Major States are Shown)

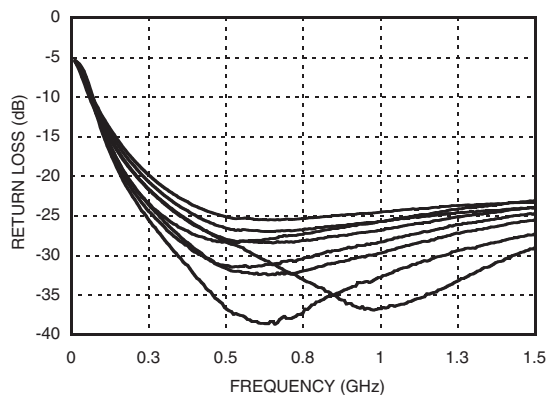

**Output Return Loss<sup>[2]</sup>**

(Only Major States are Shown)

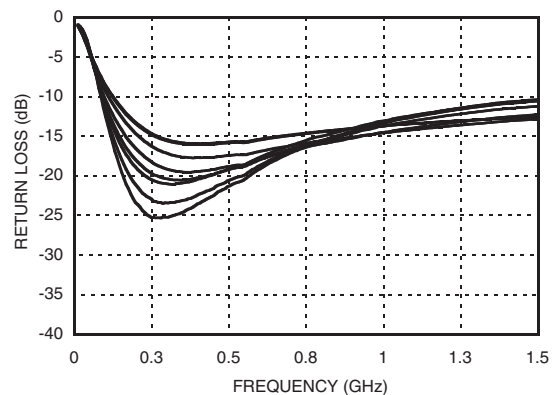

[1] Tested with broadband bias tee on output J2, C7, C8 = 10,000pF ; L1 = 680nH

[2] Data taken on eval board as described in data sheet



**0.5 dB LSB GaAs MMIC 6-BIT DIGITAL  
VARIABLE GAIN AMPLIFIER, DC - 1 GHz**

**Bit Error vs. Frequency<sup>[2]</sup>**  
(Only Major States are Shown)

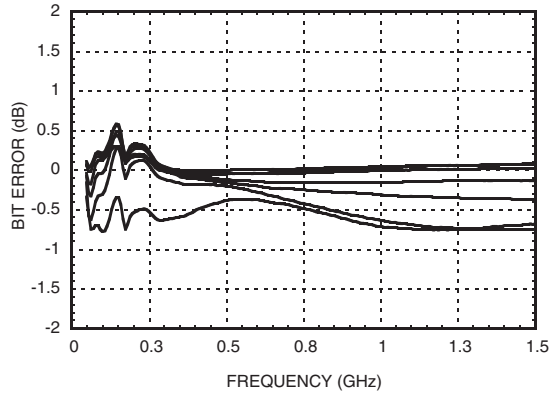

**Bit Error vs. Relative Gain Setting<sup>[2]</sup>**

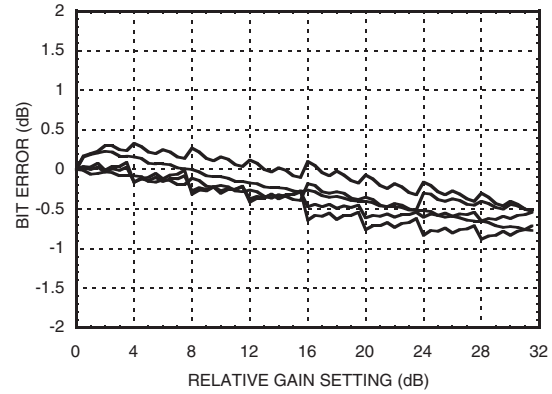

**Relative Phase vs. Frequency<sup>[2]</sup>**  
(Only Major States are Shown)

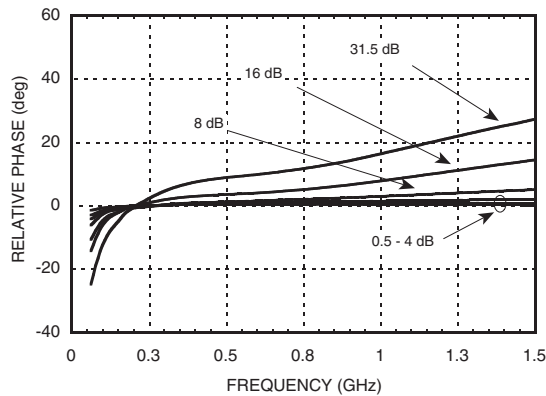

**Step Error vs. Frequency<sup>[2]</sup>**  
(Only Major States are Shown)

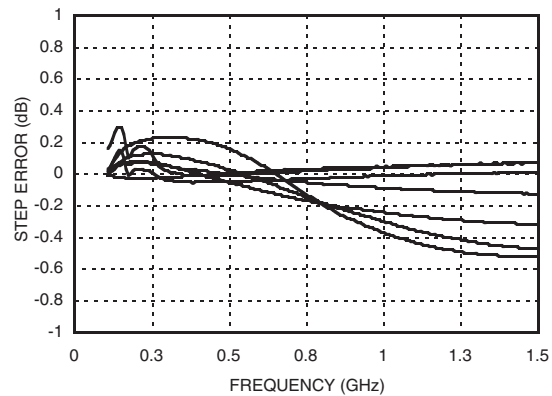

[1] Tested with broadband bias tee on output J2, C7, C8 = 10,000pF ; L1 = 680nH

[2] Data taken on eval board as described in data sheet



## 0.5 dB LSB GaAs MMIC 6-BIT DIGITAL VARIABLE GAIN AMPLIFIER, DC - 1 GHz

### Bias Voltage & Current

Vdd (V)	Idd (Typ.) (mA)
+4.5	4.7
+5.0	5.0
+5.5	5.3
Vs (V)	Is (mA)
+5.0	176

### Control Voltage Table

State	Vdd = +3V	Vdd = +5V
Low	0 to 0.5V @ <1 $\mu$ A	0 to 0.8V @ <1 $\mu$ A
High	2 to 3V @ <1 $\mu$ A	2 to 5V @ <1 $\mu$ A

### Truth Table

Control Voltage Input						Relative Gain Setting
V1 16 dB	V2 8dB	V3 4 dB	V4 2 dB	V5 1 dB	V6 0.5 dB	
High	High	High	High	High	High	Reference 0 dB
High	High	High	High	High	Low	-0.5 dB
High	High	High	High	Low	High	-1 dB
High	High	High	Low	High	High	-2 dB
High	High	Low	High	High	High	-4 dB
High	Low	High	High	High	High	-8 dB
Low	High	High	High	High	High	-16 dB
Low	Low	Low	Low	Low	Low	-31.5 dB

Any combination of the above states will provide a relative gain setting approximately equal to the sum of the bits selected.

## 0.5 dB LSB GaAs MMIC 6-BIT DIGITAL VARIABLE GAIN AMPLIFIER, DC - 1 GHz

### Absolute Maximum Ratings

RF Input Power <sup>[1]</sup> (At Max Gain Setting)	-10.5 dBm (T = +85 °C)
Bias Voltage (Vdd)	+5.5 Vdc
Collector Bias Voltage (Vcc)	5.5 Vdc
Channel/Junction Temperature	150 °C
Continuous P <sub>diss</sub> (T = 85 °C) (derate 19.8 mW/°C above 85 °C) <sup>[1]</sup>	1.29 W
Thermal Resistance	50.8 °C/W
Storage Temperature	-65 to +150 °C
Operating Temperature	-40 to +85 °C



ELECTROSTATIC SENSITIVE DEVICE  
OBSERVE HANDLING PRECAUTIONS

[1] The Max RF Input Power Rating will increase by 0.5 dB for every 0.5 dB reduction in gain to a maximum RF Input Power of 10 dBm.

### Outline Drawing

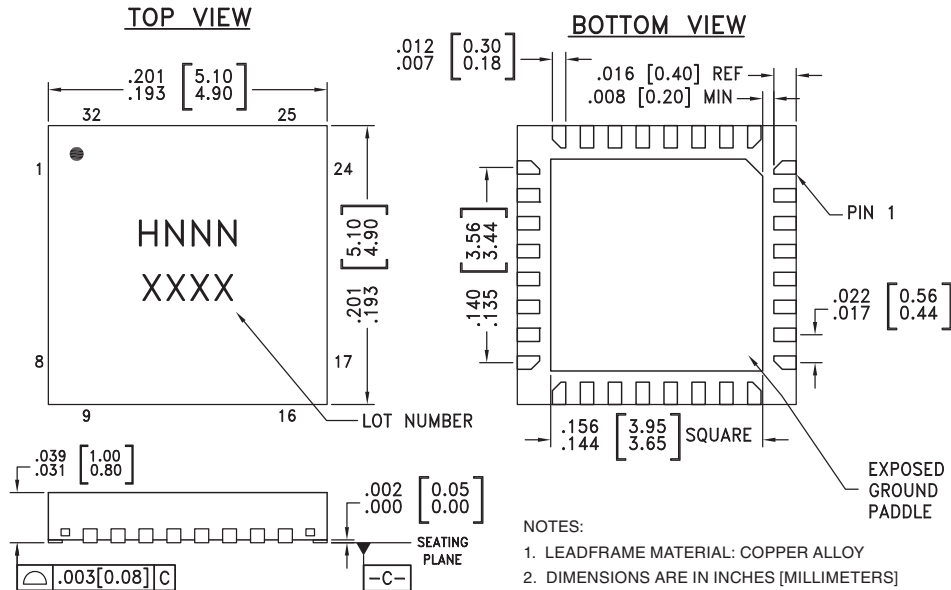

NOTES:

1. LEADFRAME MATERIAL: COPPER ALLOY
2. DIMENSIONS ARE IN INCHES [MILLIMETERS]
3. LEAD SPACING TOLERANCE IS NON-CUMULATIVE.
4. PAD BURR LENGTH SHALL BE 0.15mm MAXIMUM.  
PAD BURR HEIGHT SHALL BE 0.05mm MAXIMUM.
5. PACKAGE WARP SHALL NOT EXCEED 0.05mm.
6. ALL GROUND LEADS AND GROUND PADDLE MUST BE SOLDERED TO PCB RF GROUND.
7. REFER TO HITTITE APPLICATION NOTE FOR SUGGESTED LAND PATTERN.

### Package Information

Part Number	Package Body Material	Lead Finish	MSL Rating	Package Marking <sup>[3]</sup>
HMC626LP5	Low Stress Injection Molded Plastic	Sn/Pb Solder	MSL1 <sup>[1]</sup>	H626 XXXX
HMC626LP5E	RoHS-compliant Low Stress Injection Molded Plastic	100% matte Sn	MSL1 <sup>[2]</sup>	H626 XXXX

[1] Max peak reflow temperature of 235 °C



[2] Max peak reflow temperature of 260 °C

[3] 4-Digit lot number XXXX

For price, delivery, and to place orders, please contact Hittite Microwave Corporation:  
20 Alpha Road, Chelmsford, MA 01824 Phone: 978-250-3343 Fax: 978-250-3373  
Order On-line at [www.hittite.com](http://www.hittite.com)

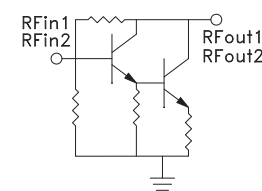

**Pin Descriptions**

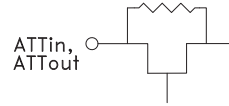
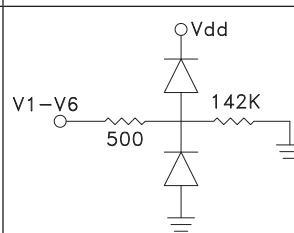
Pin Number	Function	Description	Interface Schematic
1, 5, 9, 14, 16, 23, 24, 31	N/C	These pins may be connected to RF/DC ground. Performance will not be affected.	
2, 20	RFin1, RFin2	This pin is DC coupled. An off chip DC blocking capacitor is required.	
4, 22	RFout1, RFout2	RF output and DC bias (Vcc) for the output stage of the amplifiers. Amplifier bias provided via external bias tee as shown in application circuit.	
3, 7, 18, 21	GND	These pins and package bottom must be connected to RF/DC ground.	
6, 19	ATTin, ATTout	These pins are DC coupled and matched to 50 Ohms. Blocking capacitors are required. Select value based on lowest frequency of operation.	
8, 10, 11, 12, 13, 15, 17	ACG1, ACG2, ACG3, ACG4, ACG5, ACG6, ACG7	External capacitors to ground is required. Select value for lowest frequency of operation. Place capacitor as close to pins as possible.	
25 - 30	V1 - V6	See truth table, control voltage table and timing diagram.	
32	Vdd	Supply voltage	



**0.5 dB LSB GaAs MMIC 6-BIT DIGITAL VARIABLE GAIN AMPLIFIER, DC - 1 GHz**

**Application Circuit**

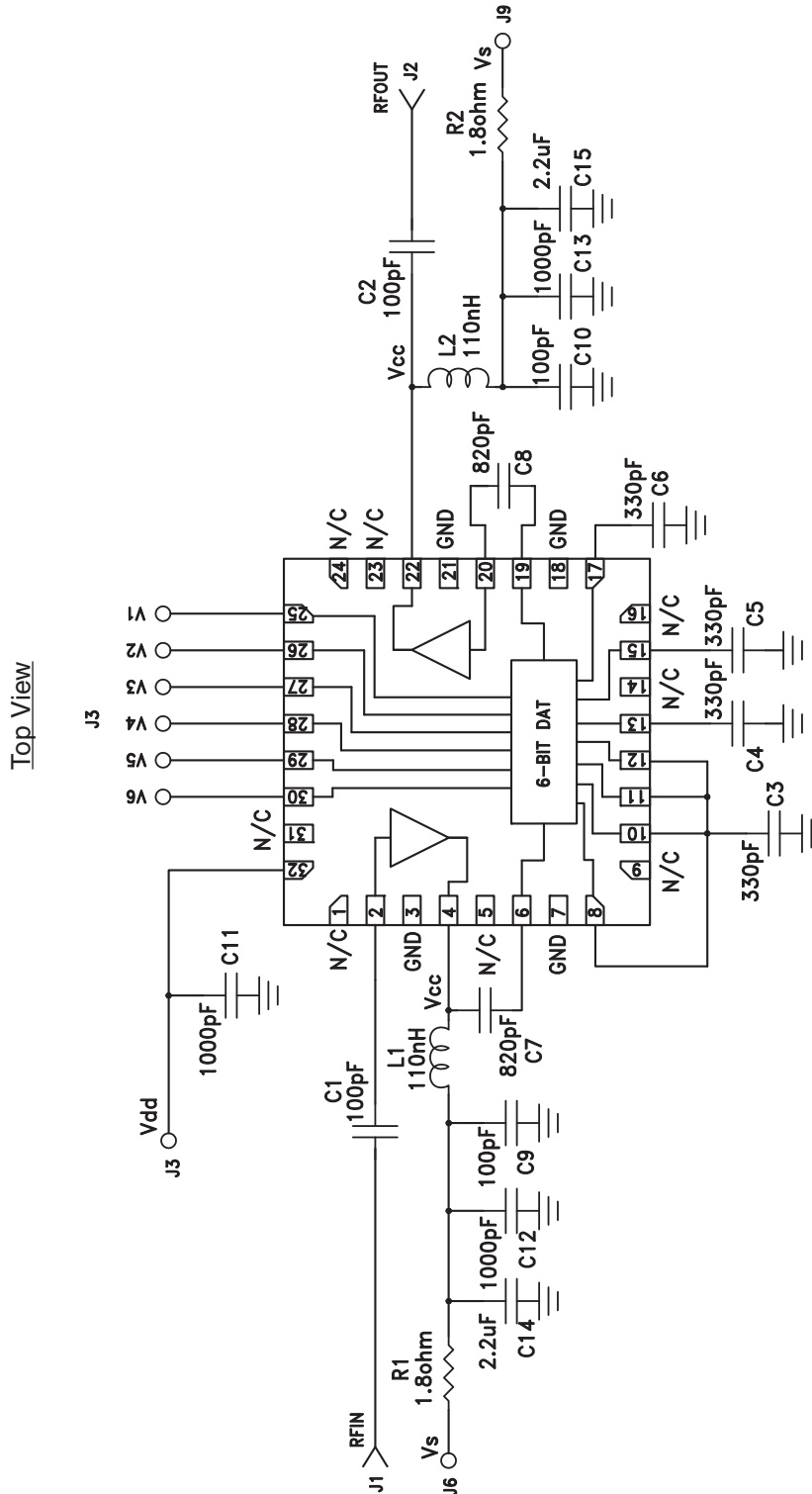

**Evaluation PCB**

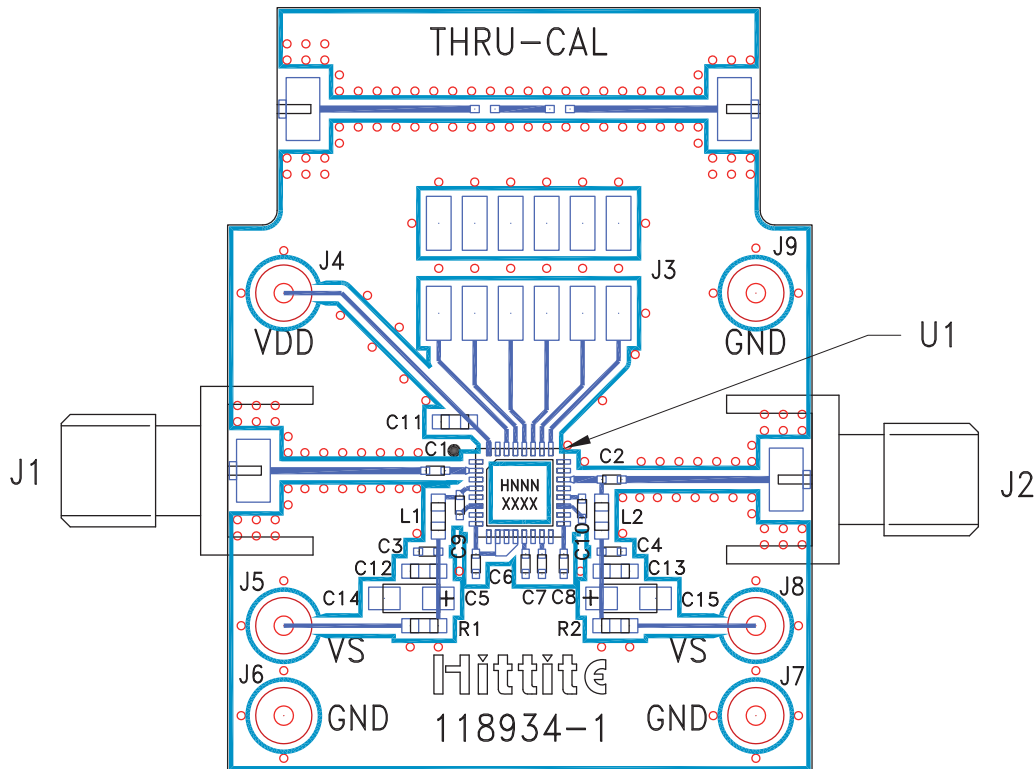

**List of Materials for Evaluation PCB 117355 [1]**

Item	Description
J1 - J2	PCB Mount SMA Connector
J3	12 Pin DC Connector
J4 - J9	DC Pin
C1, C2, C9, C10	820 pF Capacitor, 0402 Pkg.
C3, C4	100 pF Capacitor, 0402 Pkg.
C5 - C8	330 pF Capacitor, 0402 Pkg.
C11 - C13	1000 pF Capacitor, 0402 Pkg.
C14, C15	2.2 $\mu$ F Capacitor, CASE A Pkg.
R1, R2	1.8 Ohm Resistor, 0603 Pkg.
L1, L2	110 nH Inductor, 0603 Pkg.
U1	HMC626LP5(E) Variable Gain Amplifier
PCB [2]	118934 Evaluation PCB

[1] Reference this number when ordering complete evaluation PCB

[2] Circuit Board Material: Arlon 25FR

The circuit board used in the final application should use RF circuit design techniques. Signal lines should have 50 ohm impedance while the package ground leads and exposed paddle should be connected directly to the ground plane similar to that shown. A sufficient number of via holes should be used to connect the top and bottom ground planes. The evaluation circuit board shown is available from Hittite upon request.